



# Instruction Manual

## Whiz Bang Poppers

Model No. 2003, 2003ST



Model 2003





Model 2003ST







**GOLD MEDAL® PRODUCTS CO.**



10700 Medallion Drive, Cincinnati, Ohio 45241-4807 USA



## SAFETY PRECAUTIONS

	 <b>DANGER</b>
	<p>Machine must be properly grounded to prevent electrical shock to personnel. Failure to do so could result in serious injury, or death.  <b>DO NOT</b> immerse any part of this equipment in water.  <b>DO NOT</b> use excessive water when cleaning.            Keep cord and plug off the ground and away from moisture.            Always unplug the equipment before cleaning or servicing.            Make sure all machine switches are in the OFF position before plugging the equipment into the receptacle.</p> <p style="text-align: right; font-size: small;">008_051514</p>



	 <b>DANGER</b>
	<p>Improper installation, adjustment, alteration, service, or maintenance can cause property damage, injury, or death. Any alterations to this equipment will void the warranty and may cause a dangerous condition. This appliance is not intended to be operated by means of an external timer or separate remote-control system. <b>NEVER</b> make alterations to this equipment. Read the Installation, Operating, and Maintenance Instructions thoroughly before installing, servicing, or operating this equipment.</p> <p style="text-align: right; font-size: small;">014_020416</p>



	 <b>WARNING</b>
	<p>To avoid burns, <b>DO NOT</b> touch the kettle or any heated surface. <b>DO NOT</b> place or leave objects in contact with heated surfaces.</p> <p style="text-align: right; font-size: small;">013_092414</p>

	 <b>WARNING</b>
	<p><b>ALWAYS</b> wear safety glasses when servicing this equipment.</p> <p style="text-align: right; font-size: small;">010_010914</p>

	 <b>WARNING</b>
	<p>No user serviceable parts inside. Refer servicing to qualified service personnel.</p> <p style="text-align: right; font-size: small;">011_051514</p>

	 <b>WARNING</b>
	<p>Read and understand operator's manual and all other safety instructions before using this equipment. To order copies of the operator's manual go to <a href="http://gmpopcorn.com">gmpopcorn.com</a> or write to Gold Medal Products Co., 10700 Medallion Drive, Cincinnati, OH 45241 USA 1-(800)-543-0862</p> <p style="text-align: right; font-size: small;">022_060215</p>

	 <b>WARNING</b>
	DO NOT allow direct contact of this equipment by the public when used in food service locations. Only personnel trained and experienced in the equipment operation may operate this equipment. Carefully read all instructions before operation. <small>012_010914</small>

	 <b>WARNING</b>
	This machine is NOT to be operated by minors. <small>007_010914</small>

**Note:** Improvements are always being made to Gold Medal's equipment. This information may not be the latest available for your purposes. It is critical that you call Gold Medal's Technical Service Department at 1-800-543-0862 for any questions about your machine operations, replacement parts, or any service questions. (Gold Medal Products Co. does not assume any liability for injury due to careless handling and/or reckless operation of this equipment.) General images may be used in manual for reference only.

# INSTALLATION INSTRUCTIONS

## Inspection of Shipment

After unpacking, check thoroughly for any damage which may have occurred in transit. Claims should be filed immediately with the transportation company. The warranty does not cover damage that occurs in transit, or damage caused by abuse, or consequential damage due to the operation of this machine, since it is beyond our control (reference warranty in back of manual).

## Manual

Read and understand the operator's manual and all other safety instructions before using this equipment. To order copies of the operator's manual go to [gmpopcorn.com](http://gmpopcorn.com) or write to Gold Medal Products Co., 10700 Medallion Drive, Cincinnati, OH 45241 USA 1-(800)-543-0862.

## Model Description

**2003:** 12/14 oz. Whiz Bang Popper with a white molded, LED lighted dome.

**2003ST:** 12/14 oz. Whiz Bang Popper with a stainless steel dome and a white, LED lighted Popcorn sign.

## Items Included with this Unit



**Aluminum Scoop**  
(PN 2071)



**Measure 14.7 cc**  
(PN 47679)



**1/2 Cup Measure**  
(PN 47149)



**12 oz. Corn Measure**  
(PN 47148)



**Black Crutch Tips**  
(PN 49123; sold individually)



## Setup

This unit has been tested at the factory.

1. Remove all packaging and tape prior to operation.
2. Place the unit on a sturdy, level base.
3. The Popper blower vents out the top of unit, allow adequate clearance for airflow.
4. The popper unit has 4 glide feet preinstalled at the factory. Install a Black Crutch Tip on each of the 4 glide feet. Firmly push the crutch tip over the glide until it covers the glide entirely.
5. The door knobs are shipped facing the inside of the machine. Re-adjust knobs to face the outside of the machine.
6. Make sure kettle lead-in cord is securely plugged into unit, and twisted to lock into the kettle receptacle.
7. After setup, the unit should be cleaned prior to use (see Care and Cleaning section of this manual).

## Electrical Requirements

The following power supply must be provided (reference unit Data Plate):

120 V~, 60 Hz

	<b>⚠ DANGER</b>
	<p>Machine must be properly grounded to prevent electrical shock to personnel. Failure to do so could result in serious injury, or death. DO NOT immerse any part of this equipment in water. DO NOT use excessive water when cleaning. Keep cord and plug off the ground and away from moisture. Always unplug the equipment before cleaning or servicing. Make sure all machine switches are in the OFF position before plugging the equipment into the receptacle.</p> <p>008_051514</p>

A certified electrician must furnish sufficient power for proper machine operation and install any supplied receptacle. We recommend this equipment be on a dedicated and protected circuit. Failure to wire properly will void the warranty and may result in damage to the machine. It is Gold Medal Products Co.'s recommendation that this machine be plugged directly into a wall outlet. The use of extension cords is not recommended due to safety concerns, and may cause sacrificed and/or reduced performance. Make sure cord is located to prevent a trip hazard or unit upset.

## Before You Plug In Machine

1. Make sure all machine switches are OFF before plugging equipment into receptacle.
2. Make sure wall outlet can accept the grounded plugs (where applicable) on the power supply cord.
3. The wall outlet must have the proper polarity. If in doubt, have a competent electrician inspect the outlet and correct if necessary.
4. **DO NOT** use a grounded to un-grounded receptacle adapter (where applicable).
5. Install unit in a level position.

	<b>⚠ CAUTION</b>
	<p>If the supply cord is damaged, it must be replaced by Gold Medal Products Co., its service agent or similarly qualified persons in order to avoid a hazard.</p> <p>039_080614</p>

# OPERATING INSTRUCTIONS

## Controls and Their Functions

### LIGHTS SWITCH

Two position, ON/OFF lighted rocker switch - supplies power to the popcorn sign, interior cabinet light. The green switch light ON indicates there is power to the lights.

### KETTLE HEAT SWITCH

Two position, ON/OFF lighted rocker switch - supplies power to the heating elements in the popping kettle. The green switch light ON indicates there is power to the kettle heating element.

### KETTLE MOTOR SWITCH

Two position, ON/OFF lighted rocker switch - supplies power to the kettle agitator motor and exhaust blower. The Kettle Motor Switch **MUST** be ON at all times when there is popcorn (popped or un-popped) in the kettle. The green switch light ON indicates there is power to the agitator motor and exhaust blower.

### WARMER SWITCH

Two position, ON/OFF lighted rocker switch - supplies power to the heat element for the corn deck freshener. The green switch light ON indicates there is power to the corn pan heat element.

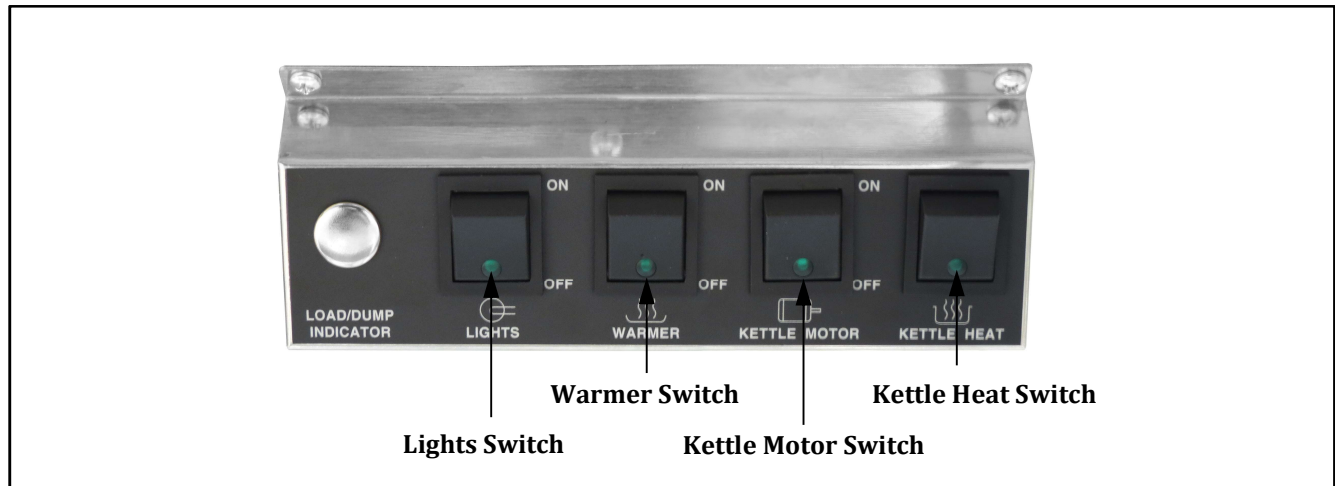



# Popping Corn

This section describes instructions for popping Standard (salted popcorn).

## Amount of Popcorn and Oil

The popper is equipped with a corn, salt, and oil measure. We recommend flavored and colored coconut oil. Popcorn popped in coconut oil stays fresh longer and does not leave black deposits in the kettle like other oils. Use only top quality, fresh popcorn from reputable suppliers.

### Ingredient amounts for popping Standard Popcorn:

Kettle Size	Popcorn Charge	Oil Charge	Flavacol (Salt)
12 oz.	12 oz. (355 ml)	4 oz. (118 ml)	1 Tblsp. (15cc)
14 oz.	14 oz. (414 ml)	4.5 oz. (133 ml)	1 Tblsp. (15cc)

For best results use Mega-Pop® 12 oz. premeasured pouches (Item# 2839).

## Popping Standard (Salted) Popcorn

1. Turn the Lights/Warmer, Kettle Heat and Kettle Motor Switches ON.
2. To determine when the kettle is ready to pop corn (about 4 minutes), test pop three kernels of corn and one ounce (30 ml) of popping oil. When the kernels pop, the kettle is ready for use.
3. Lift the kettle lid and load the Mega-Pop® premeasured popcorn and oil pouch into kettle, or pour in the popcorn and Flavacol, then add oil in the premeasured amounts specified above. Close lid.
4. When the corn has finished popping, gently dump the popcorn.
5. On the final kettle of corn, turn the Kettle Heat Switch OFF just as the lids are forced open by the popping corn. This procedure saves electricity, since the kettle has plenty of heat, and helps eliminate smoke/odor from any oil residue that remains after popping has stopped.
6. When finished popping, make sure KETTLE HEAT and KETTLE MOTOR switches are turned OFF.

**NEVER LEAVE THE HEAT ON WHEN YOU ARE NOT POPPING CORN!**

## Care and Cleaning

	<b>⚠ DANGER</b>
	Machine must be properly grounded to prevent electrical shock to personnel. <b>DO NOT immerse in water.</b> DO NOT clean appliance with a water jet. Always unplug the equipment before cleaning or servicing. <span style="float: right;">025_111616</span>

	<b>⚠ WARNING</b>
	To avoid serious burns, DO NOT touch the kettle while it is hot! <span style="float: right;">028_082715</span>

Good sanitation practice demands that all food preparation equipment be cleaned regularly (only use non-toxic, food grade cleaners). A clean looking, well-kept machine is one of the best ways of advertising your product.

**Note:** It is extremely important to follow all of the cleaning procedures, otherwise parts damage and equipment failure will result. The warranty does not cover parts that are damaged due to improper cleaning.

### Daily Kettle Cleaning Instructions

**CAUTION:** A hot kettle will cause burns if you touch it with your hand. Allow kettle to cool at least 1 hour before attempting to clean. **DO NOT** use ice or water to cool down a hot kettle! Severe kettle damage will result!

1. When cool, wipe the **outside** of the kettle with a clean, soft cloth. **DO NOT** use oven cleaners or abrasive materials as they will damage the kettle.
2. Every night, mix Gold Medal's Heat'n Kleen solution (Item No. 2095), 2 tablespoons per gallon of water. It is not necessary to use the entire gallon at once; only use enough to fill the kettle 1/2 inch deep.
3. Turn the kettle heat ON. When the water starts to boil, turn the kettle heat OFF.
4. Allow to cool for at least 1 hour, then dump the solution into a bucket and wipe the inside of the kettle with a clean cloth. Make sure all of the solution goes into the bucket; do not spill any in the interior of the machine.

For an extra dirty kettle, the process may be repeated; or, after turning the kettle heat OFF, allow solution to sit in the kettle overnight. The next morning, dump the solution into a bucket and wipe the inside of the kettle with a clean cloth.

5. With the unit OFF and unplugged, wipe the kettle lead cord with a clean SLIGHTLY damp cloth. **DO NOT get moisture into the kettle lead-in cord, severe damage will result.**

## Daily Unit Cleaning Instructions

1. With the machine OFF, unplug the unit and allow it to cool before attempting to clean.
2. Make sure to clean all pans/accessories in order to sanitize them before each use.
3. Take a clean, SLIGHTLY damp cloth and wipe excess grease from the glass and cabinet.
4. Wipe the stainless steel parts with a clean cloth and cleaner designed for stainless steel, such as Gold Medal Watchdog Stainless Cleaner (Item No. 2088).

**DO NOT** use oven cleaners or abrasive materials as they will damage parts of the machine.

5. Clean the glass panels with glass cleaner. Gold Medal Watchdog Glass Cleaner (Item No. 2588) is recommended.

Ammonia cleaners will damage the plastic doors. Use only non-ammonia cleaners, such as Gold Medal Watchdog Glass Cleaner (Item No. 2588).

## Weekly Filter Cleaning Instructions

Your popcorn machine is equipped with an efficient and durable filtration system. The filter should be cleaned every week to maintain maximum efficiency.

Follow the steps below for proper filter cleaning:

**Step 1:** The filter is located on the inside of the popcorn machine above the popping kettle.

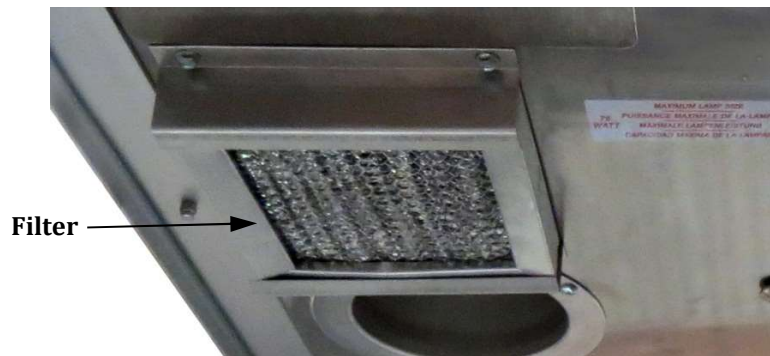

**Step 2:** Remove the filter by sliding it out of the filter retaining angles.

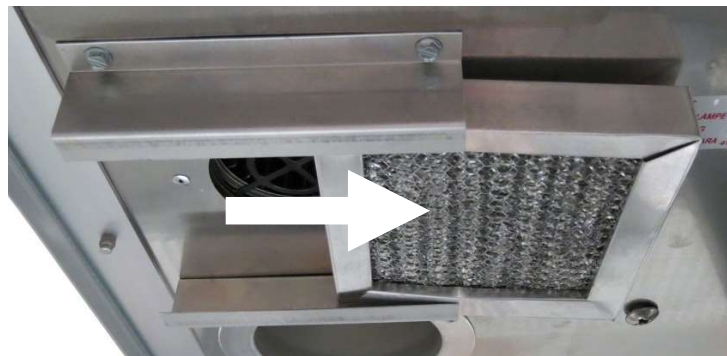

**Step 3:** Clean the filter in warm soapy water, then rinse and allow to dry overnight. Reinstall filter to its original position (as shown above).



---

## Clean the Crisper/Blower Compartment

The blower compartment **MUST** be inspected/cleaned every 3-4 months by Qualified Service Personnel to maintain proper operation.

1. With the machine OFF, unplug the unit and allow it to cool before attempting to clean.
2. Lift off the corn pan to view the blower assembly.
3. Remove the blower cover and if required, carefully clean the blower compartment, and underneath the element with a vacuum only.
4. After cleaning, reassemble blower cover and corn pan.



## Troubleshooting

Issue	Possible Cause	Solution
<b>Power to the Unit</b>	A. Power to the Unit	A. Make sure the unit's power cord is plugged in.
<b>Kettle Does Not Heat</b>	A. Power to the Kettle B. Kettle Heat Switch C. Heating Element	A. Make sure kettle lead-in cord is plugged in and twisted to lock into the kettle receptacle. B. Have a qualified service person check the voltage to and from the Kettle Heat Switch; if switch is defective, replace it. C. Heating element in the kettle may be burned out. Check with a qualified service person for inspection/repair.
<b>Long Popping Cycles</b> (Longer than 4 minutes for Salt Popcorn)	A. Low Voltage B. Inadequate Supply Lines C. Inferior Corn	A. If the machine is operated on low voltage, this could cause the kettle not to reach the proper operating temperature. Check with a qualified electrician. B. Inadequately sized electrical supply lines or use of extension cord, in addition to being a fire hazard, would also prevent the kettle from reaching the proper operating temperature. Check with a qualified electrician. C. Inferior quality corn would result in longer popping cycles. Use only top quality hybrid popcorn from reputable suppliers. Even then, if you let your corn pick up moisture or dry out, your popping cycles will be slow.
<b>Kettle Agitator Shaft not Rotating</b>	A. Kettle Motor Switch B. Kettle Agitator Shaft/Stir Blade not rotating. <b>(Unit must be OFF, unplugged and cool prior to checking or adjusting the agitator assembly.)</b>	A. If the kettle agitator shaft is not rotating, <b>DO NOT</b> pop corn. Make sure the Kettle Motor Switch is ON. If the switch is ON, and the shaft is not rotating, the switch or motor may be faulty, contact qualified service personnel for inspection/repair. B. If the kettle agitator shaft is not rotating, <b>DO NOT</b> pop corn. <ul style="list-style-type: none"> <li>• <b>Kettles with a FIXED Stir Rod</b> – check the clearance between the shaft with welded stir blade and the kettle bottom; it should be a minimum of 1/32" (thickness of a dime).</li> <li>• <b>Kettles with a FLOATING Stir Rod</b> – lift the agitator weight and check the clearance between the shaft and the kettle bottom; it should be a minimum of 1/32" (thickness of a dime).</li> </ul> To make shaft adjustments, reference the Agitator Set Collar Adjustment section.



# Agitator Set Collar Adjustment

The following instructions describe how to properly adjust set collars on an agitator assembly with a floating stir rod.

## Steps to Adjust Set Collars

**Step 1:** Turn machine OFF, unplug unit, and allow it to cool completely before attempting to adjust the agitator height.

**Step 2:** Loosen the set screw in each set collar to be adjusted.

**Step 3:** With the kettle mounted in the popper, adjust the shaft so the Spur Gears are halfway engaged, and the Needle Bearing is at least halfway engaged in the gear block (reference image at right).

**DO NOT** set spur gears at full gear contact; it can cause binding as the kettle is dumped.

**Step 4:** Snug tighten only, the set screw in set collar above the crossbar to hold position. Then, lift the agitator weight and check the clearance between the shaft and the kettle bottom. If there is adequate clearance, fully tighten the set screw to secure set collar in place.

**Step 5:** Adjust clearance between the bottom of the crossbar and the lower set collar to 1/32" (thickness of a dime); then re-tighten set screw to secure in place (reference image).



**Step 6:** Adjust set collar for agitator weight to be between 3/16" to 1/4" above the agitator weight. Once adjusted, re-tighten set screw to secure in place.

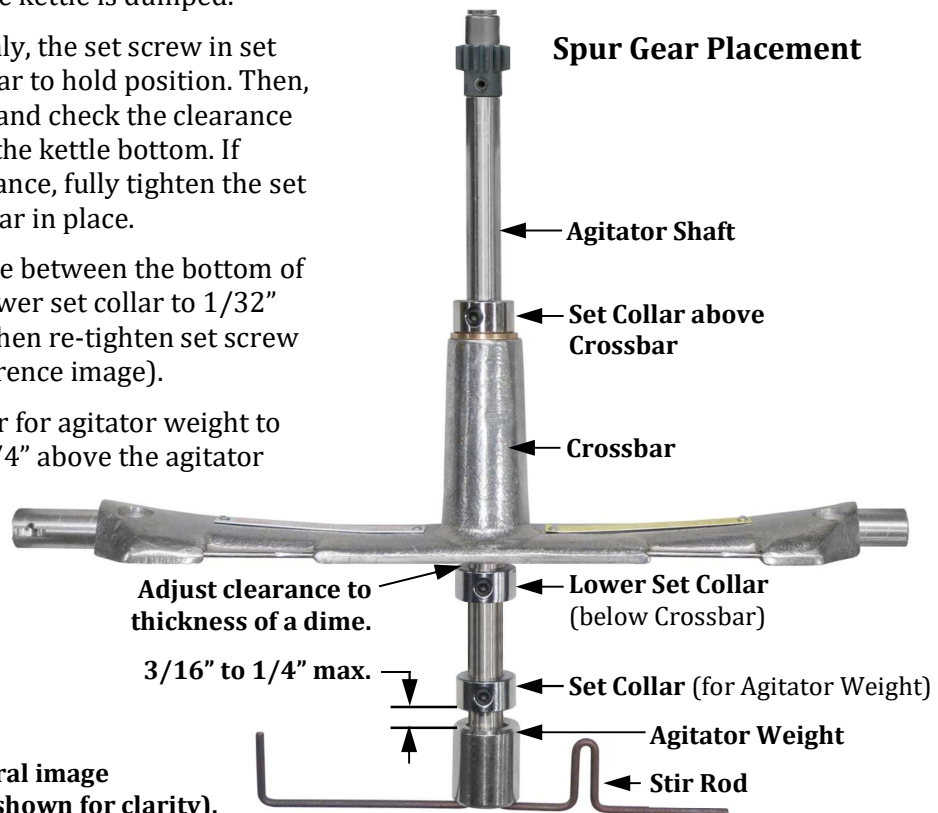
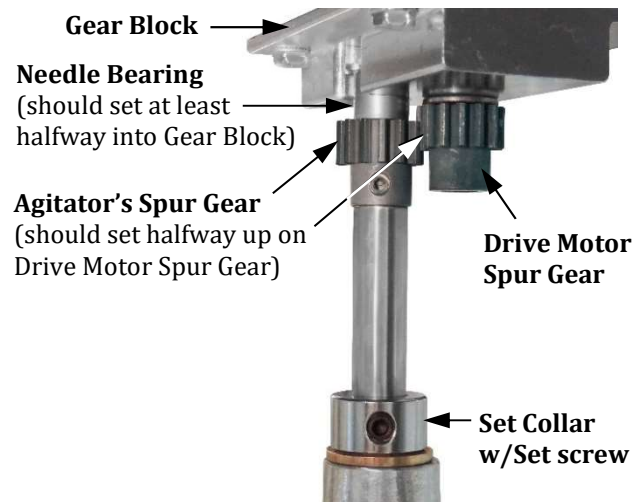

Agitator shown for general image reference only (lids not shown for clarity).







# MAINTENANCE INSTRUCTIONS

	 <b>DANGER</b>
	<p>Machine must be properly grounded to prevent electrical shock to personnel. Failure to do so could result in serious injury, or death.  <b>DO NOT</b> immerse any part of this equipment in water.  <b>DO NOT</b> use excessive water when cleaning.            Keep cord and plug off the ground and away from moisture.            Always unplug the equipment before cleaning or servicing.            Make sure all machine switches are in the OFF position before plugging the equipment into the receptacle.</p> <p style="text-align: right; font-size: small;">008_051514</p>

	 <b>DANGER</b>
	<p>Improper installation, adjustment, alteration, service, or maintenance can cause property damage, injury, or death. Any alterations to this equipment will void the warranty and may cause a dangerous condition. This appliance is not intended to be operated by means of an external timer or separate remote-control system. <b>NEVER</b> make alterations to this equipment. Read the Installation, Operating, and Maintenance Instructions thoroughly before installing, servicing, or operating this equipment.</p> <p style="text-align: right; font-size: small;">014_020416</p>

	 <b>WARNING</b>
	<p>No user serviceable parts inside. Refer servicing to qualified service personnel.</p> <p style="text-align: right; font-size: small;">011_051514</p>

	 <b>CAUTION</b>
	<p>THE FOLLOWING SECTIONS OF THIS MANUAL ARE INTENDED ONLY FOR QUALIFIED SERVICE PERSONNEL WHO ARE FAMILIAR WITH ELECTRICAL EQUIPMENT. THESE ARE NOT INTENDED FOR THE OPERATOR.</p> <p style="text-align: right; font-size: small;">027_010914</p>



---

## ORDERING SPARE PARTS

1. Identify the needed part by checking it against the photos, illustrations, and/or parts list. (General images may be used in manual for reference only.)
2. Use only approved replacement parts when servicing this unit.
3. When ordering, please include part number, part name, and quantity needed.
4. Please include your model number, serial number, and date of manufacture (located on the machine nameplate/data plate) with your order.
5. Address all parts orders to:

Parts Department  
Gold Medal Products Co.  
10700 Medallion Drive  
Cincinnati, Ohio 45241-4807

Or, place orders by phone or online:

Phone: (800) 543-0862  
(513) 769-7676  
Fax: (800) 542-1496  
(513) 769-8500  
E-mail: [info@gmpopcorn.com](mailto:info@gmpopcorn.com)  
Web Page: [gmpopcorn.com](http://gmpopcorn.com)



## Replacing Broken Glass

Broken glass panels can be easily replaced. Gold Medal Products Co. does not ship glass. It can be obtained from a local glass shop, always purchase tempered glass.

### GLASS DIMENSIONS (Height x Width x Thickness)

**Front Glass:** 28 3/16" X 22 15/16" X 1/8" (1 Piece)

**Side Glass:** 28 3/16" X 15 1/2" X 1/8" (2 Pieces)

1. With the machine OFF, unplug the unit and allow it to cool before attempting to replace any glass.
2. Carefully remove all loose pieces of broken glass.
3. Lift out the corn pan (bottom pan).
4. Locate the Glass Retainer Strips on each corner post holding in the glass panel, and remove the screws to unfasten the retainers.
5. Carefully remove the rest of the broken glass.
6. Remove all rigid glass channels from around the glass to be replaced, set channels aside for reuse.
7. Apply decals (if desired) to the new glass panel.
8. Slide the rigid glass channels over the exposed sides and bottom of the new glass panel.
9. Fasten new glass panel in machine with the existing glass strips and screws.
10. Reinstall corn pan (bottom pan).

## 12/14 oz. Kettle Assy. (58220) – Agitator Assy.

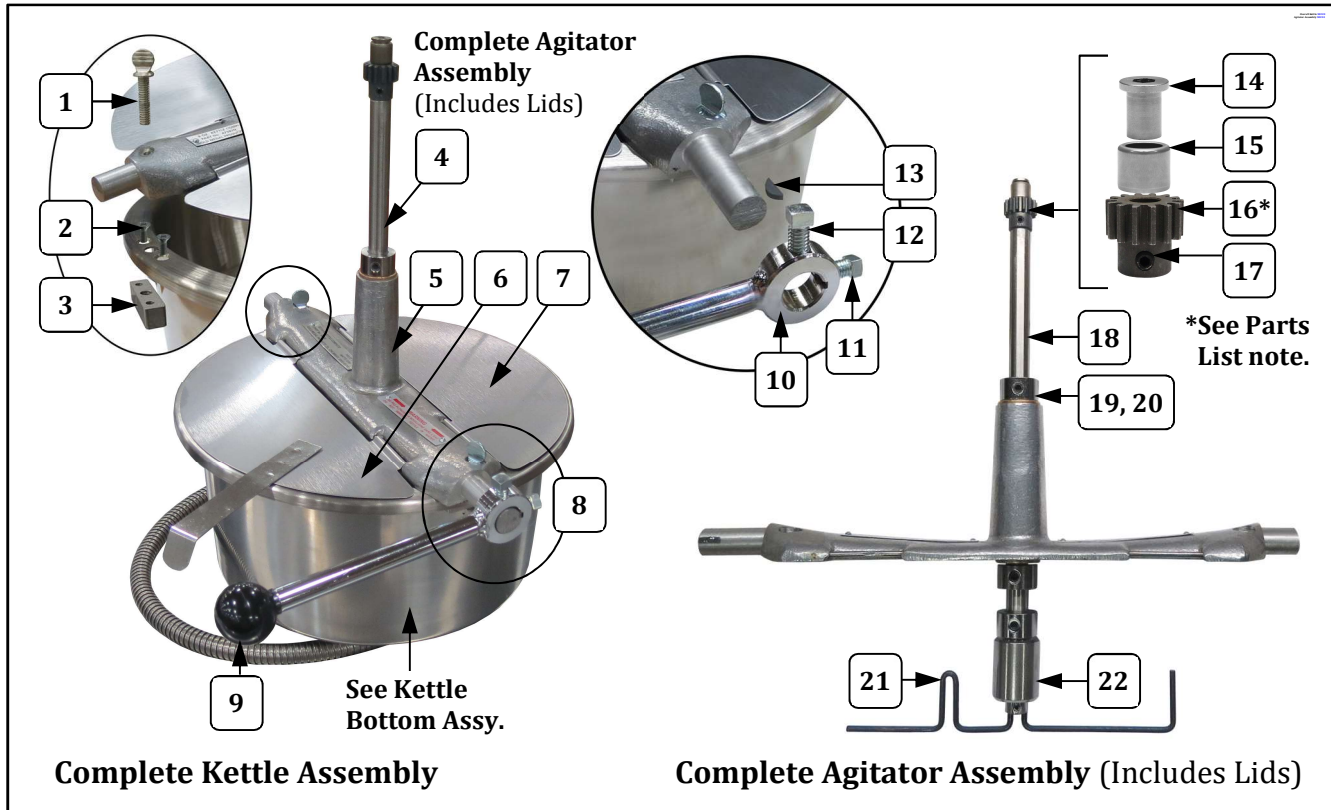

Item	Part Description	Part Number
		58220
1	1/4-20 X 1.25 THUMB SCREW	61068
2	8-32 x 1/2 FH MS PH	106064
3	SHELL & KETTLE BLOCK	61013
4	12/14 OZ LID&AGITATOR ASSY (Complete Assy.)	58219
5	CROSSBAR ASSEMBLY	61025
6	FORMED LID	47261
7	REAR KETTLE LID	47119
8	DUMP HANDLE ASSEMBLY (assembly includes Handle, Knob, 2 SQ HD Screws, and Key)	47102
9	DUMP HANDLE KNOB	47110
10	DUMP HANDLE	47707
11	5/16-18 X 3/8 SQ HD SCREW (holds Key)	47662
12	5/16-18 X 1/2 SQ HD SCREW	47725
13	WOODRUFF KEY #3 1/8X1/2	41730
14	AGITATOR BEARING HUB	43434
15	NEEDLE BEARING	47106
16*	SPUR GEAR Kit (Includes 2 gears w/set screws. Always replace Agitator Spur Gear and Kettle Drive Motor Gear as a set.)	47059K
17	10-32 X 3/16 SET SCREW	41742
18	AGITATOR SHAFT	61092
19	1/2ID X 7/8OD SET COLLAR	47326
20	SET SCREW 1/4-20 X 3/16	47751
21	STIR ROD	49011
22	AGITATOR WEIGHT	61093



## 12/14 oz. Kettle Assembly (58220) – Kettle Bottom View

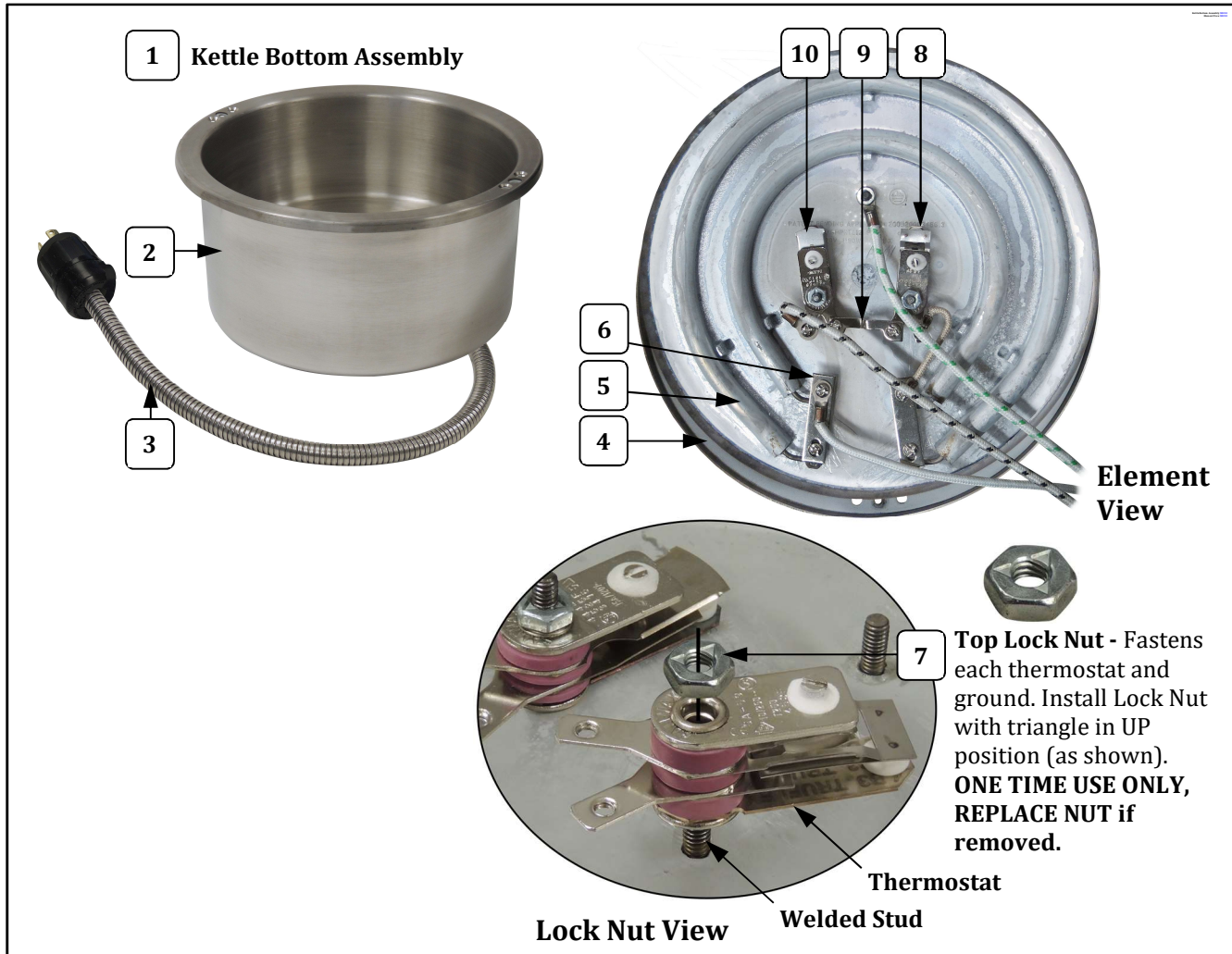

Item	Part Description	Part Number
		58220
1	12/14 OZ. KETTLE BOTTOM ASSEMBLY (includes parts listed below)	58221
2	KETTLE SHELL	61017
3	KETTLE LEAD ASSY	61053
4	KETTLE GASKET	61012
5	KETTLE INTEGRAL HTR 12/14	58011
6	12/14OZ SHUNT BAR	77879
7	8-32 TOP LOCK NUT (always replace if removed)	67943
8	482°F THERMOSTAT (includes two 6-32 screws)	76708
9	THERMOSTAT SHUNT BAR	47193
10	550°F THERMOSTAT (includes two 6-32 screws)	77108



## Cabinet Exterior – Front View

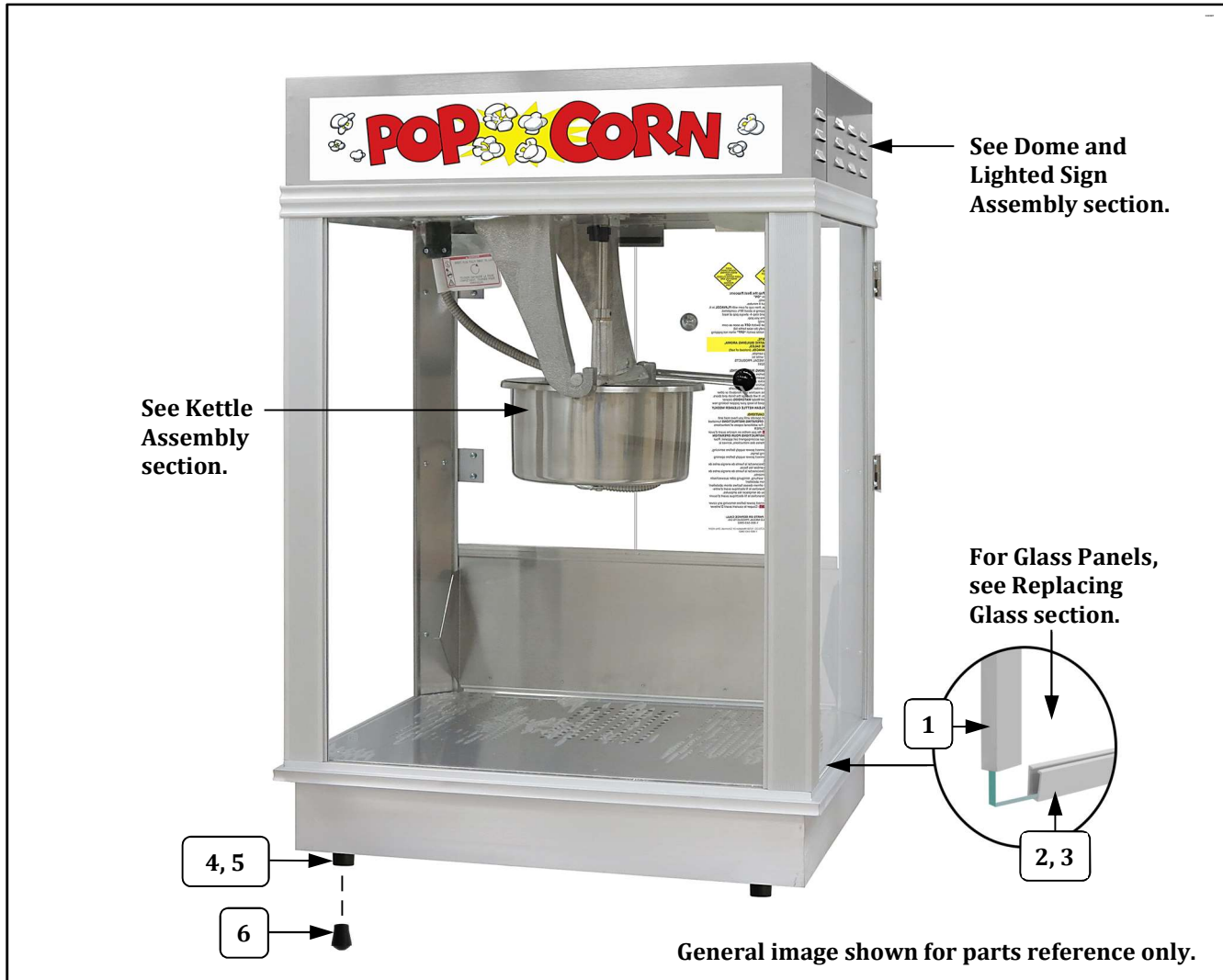

Item	Part Description	Part Number
		2003 2003ST
1	27 13/16" GLASS CHANNEL (used on side edges of front and side glass panels)	47697
2	22 7/8" GLASS CHANNEL (used on bottom edge of front glass panels)	47694
3	15 3/8" GLASS CHANNEL (used on bottom edge of side glass panels)	47692
4	GLIDE	47328
5	10-24 X 3/4 HEX HD	41314
6	BLACK CRUTCH TIP	49123

## Cabinet Exterior – Rear View

**\*\*Complete Door Hardware Kit**  
(See next page for individual component breakdown).

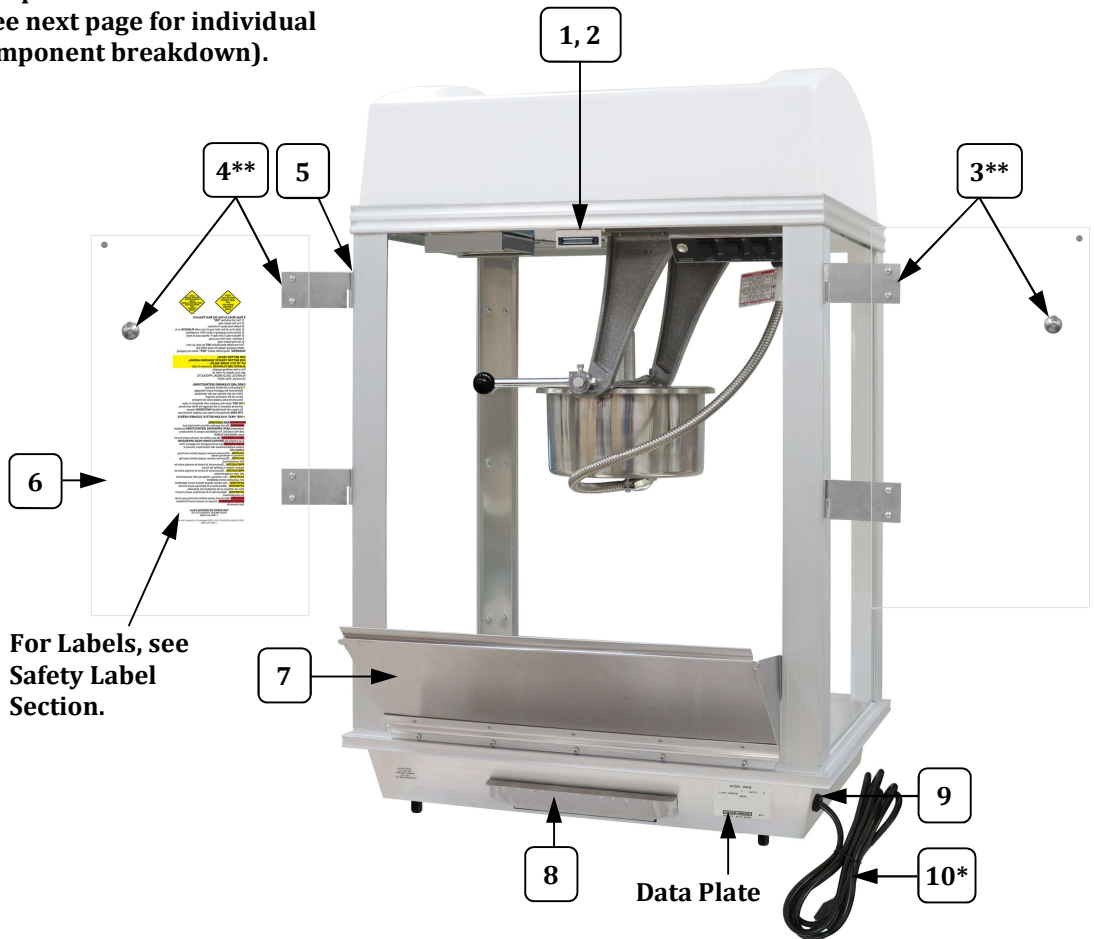

For Labels, see Safety Label Section.

**\*CAUTION:** If supply cord is damaged, it must be replaced by Gold Medal Products Co., its service agent, or similarly qualified persons in order to avoid a hazard.

Model 2003 shown

Item	Part Description	Part Number
		2003 2003ST
1	MAGNETIC CATCH	47561
2	MAGNETIC CATCH BRACKET	47559
3**	COMPLETE HARDWARE KIT FOR RH DOOR	47055
4**	COMPLETE HARDWARE KIT FOR LH DOOR	47054
5	8-32 X 3/8 SLT. HWH M/S (Frame Hinge Screws not included in Door Hardware Kit)	42044
6	DOOR	47600
7	DROP PANEL ASSEMBLY	47337
8	OLD MAID PAN	47336
9	SR-6P-4 STRAIN RELIEF	44073
10*	15 AMP POWER SUPPLY CORD	47602



## Door Hardware Kits – Individual Component Breakdown

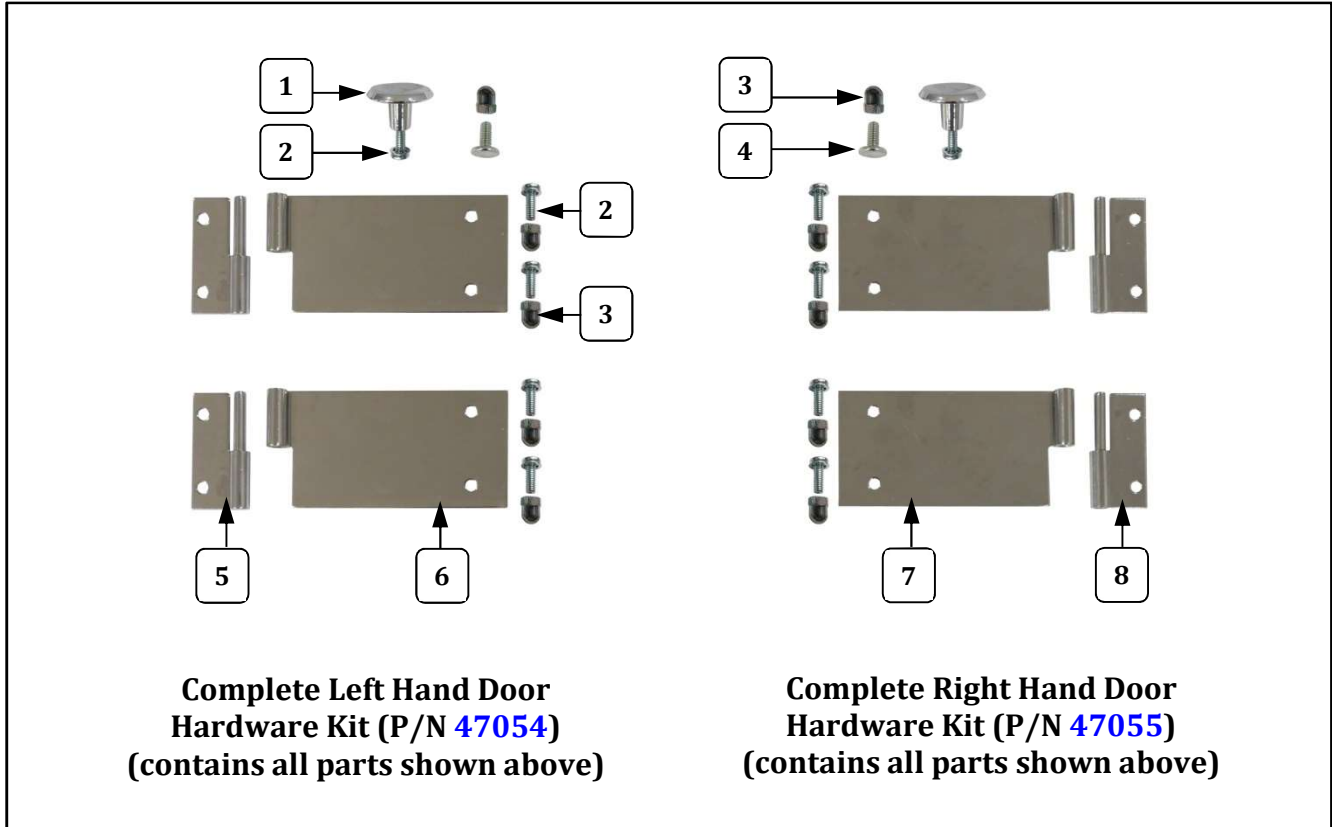

Item	Part Description	Part Number	
		47054	47055
1	DOOR KNOB	41013	41013
2	8-32 X 1/2 SCREWS PH PAN W/SEMS	47124	47124
3	ACORN NUT #8-32	47702	47702
4	TEE BOLT	75267	75267
5	MALE HINGE SHORT LEFT	41349	
6	FEMALE HINGE LONG LEFT	41352	
7	FEMALE HINGE LONG RIGHT		41351
8	MALE HINGE SHORT RIGHT		41350

## Cabinet Interior – Hanger Assembly/Controls View

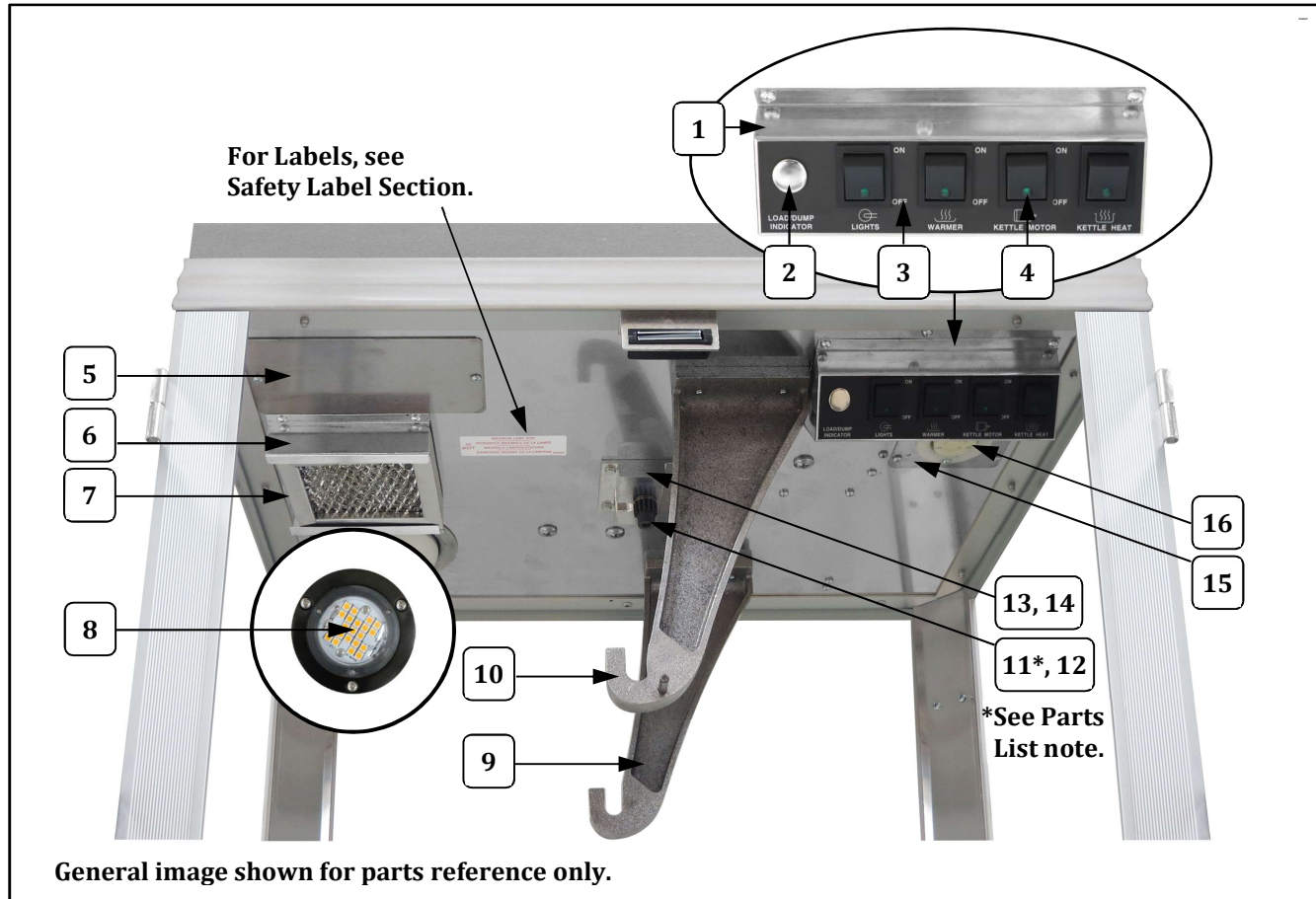

Item	Part Description	Part Number
		2003 2003ST
1	5 HOLE SWITCH BOX	17450
2	HOLE PLUG	45395
3	ROCKER SWITCH LABEL	48542
4	LIGHTED ROCKER SWITCH	42798
5	COVER PLATE FOR NO OIL	77478
6	FILTER RETAIN ANGLE	41644
7	FILTER	47043
8	LED REPLACEMENT NO PLATE	100544
9	FRONT HANGER ARM ASSEMBLY	47262
10	REAR HANGER ARM ASSEMBLY	47263
11*	SPUR GEAR KIT (Includes 2 gears with set screws. Always replace Agitator Spur Gear and Kettle Drive Motor Gear as a set.)	47059K
12	10-32" X 3/16" SET SCREW	41742
13	GEAR BLOCK ASSEMBLY	67194
14	10-24 X 1 HEX MACH SCREW (fastens gear block assembly to kettle drive motor)	49322
15	15A TWIST MOUNTING PLATE	77477
16	L5-15R 15A RECEPTACLE	49330



## Cabinet Interior – Corn Pan View

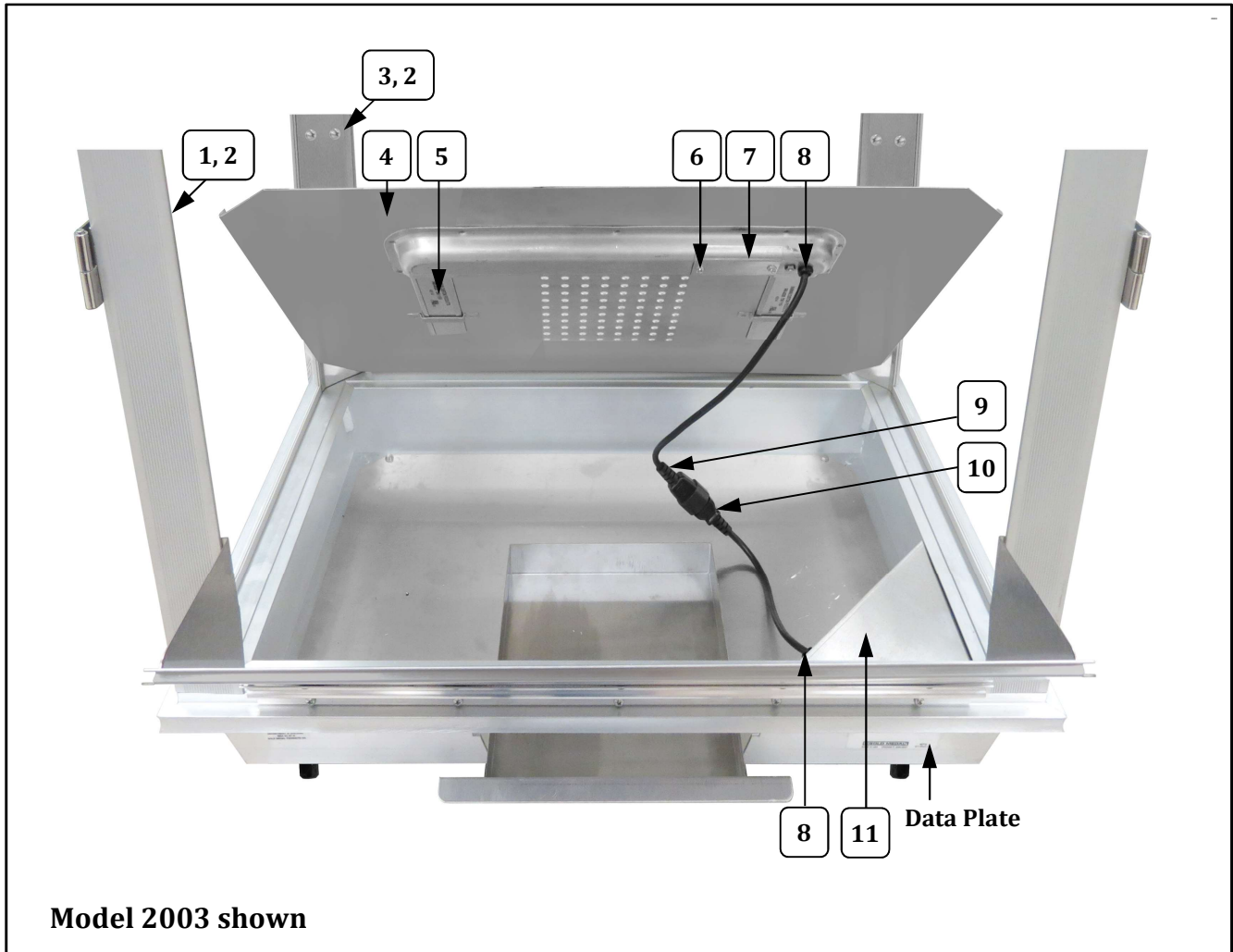

Item	Part Description	Part Number
		2003, 2003ST
1	REAR GLASS RETAINER	47592
2	8-32X1/2 PAN HD PH (fastens rear/front retainers and blower cover top)	74147
3	FRONT GLASS RETAINER	47593
4	BOTTOM CORN PAN ASSEMBLY	47598
5	115V 75W HEAT ELEMENT	44026
6	SCREW #8-32X1/2 PAN HD PH	74147
7	COVER CORN PAN CONDUIT	47653
8	SR 6P3-4 STRAIN RELIEF	61099
9	MALE CORDSET	61020
10	FEMALE CORDSET	61021
11	CORNER COVER	41879



# Dome Interior – Electrical Components

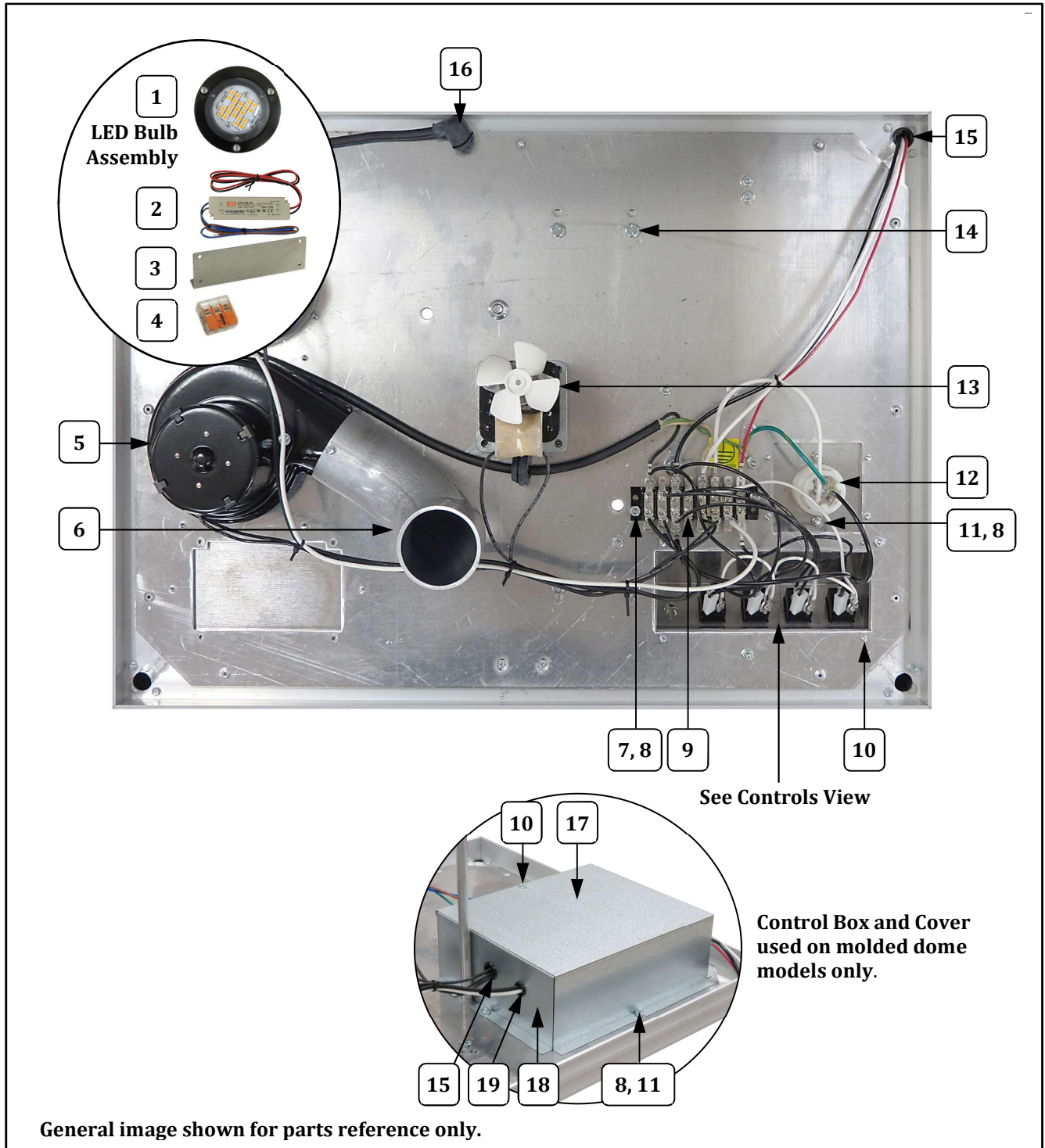



## Dome Interior – Parts List

Item	Part Description	Part Number	
		2003	2003ST
1	LED REPLACEMENT NO PLATE	100544	100544
2	POWER SUPPLY 24VDC 20W	55394	
	POWER SUPPLY 24VDC 60W		55586
3	20W POWER SUPPLY BRACKET	55414	
	60W POWER SUPPLY BRACKET		55624
4	3 POSITION WIRE CONNECTOR	55244	55244
5	120V/60CY EXHAUST BLOWER	47343	47343
6	EXHAUST ELBOW	47506	47507
7	8-32 X 3/4 PHIL PAN MS SS	39007	39007
8	8-32 HEX M/S NUT	74149	74149
9	8 POS TERMINAL BLOCK	47208	47208
10	8-32X3/8 PAN HD PH SCREW	74141	74141
11	8-32 X 1/2 PH PAN W/SEMS	47124	47124
12	L6-15R 15A-250V RECEPTACLE	49330	49330
13	120V KETTLE DRIVE MOTOR	47038	47038
14	1/4-20 X 3/4 GRADE 5 BOLT (fastens hanger arm)	74520	74520
15	.625 IN SNAP BUSHING	47282	47282
16	MOLDED RECEPTACLE	47727	47727
17	CONTROL BOX COVER	79278	
18	CONTROL BOX	79277	
19	.500 IN BUSHING SNAP	47236	



## Lighted Sign Assembly – Stainless Steel Dome

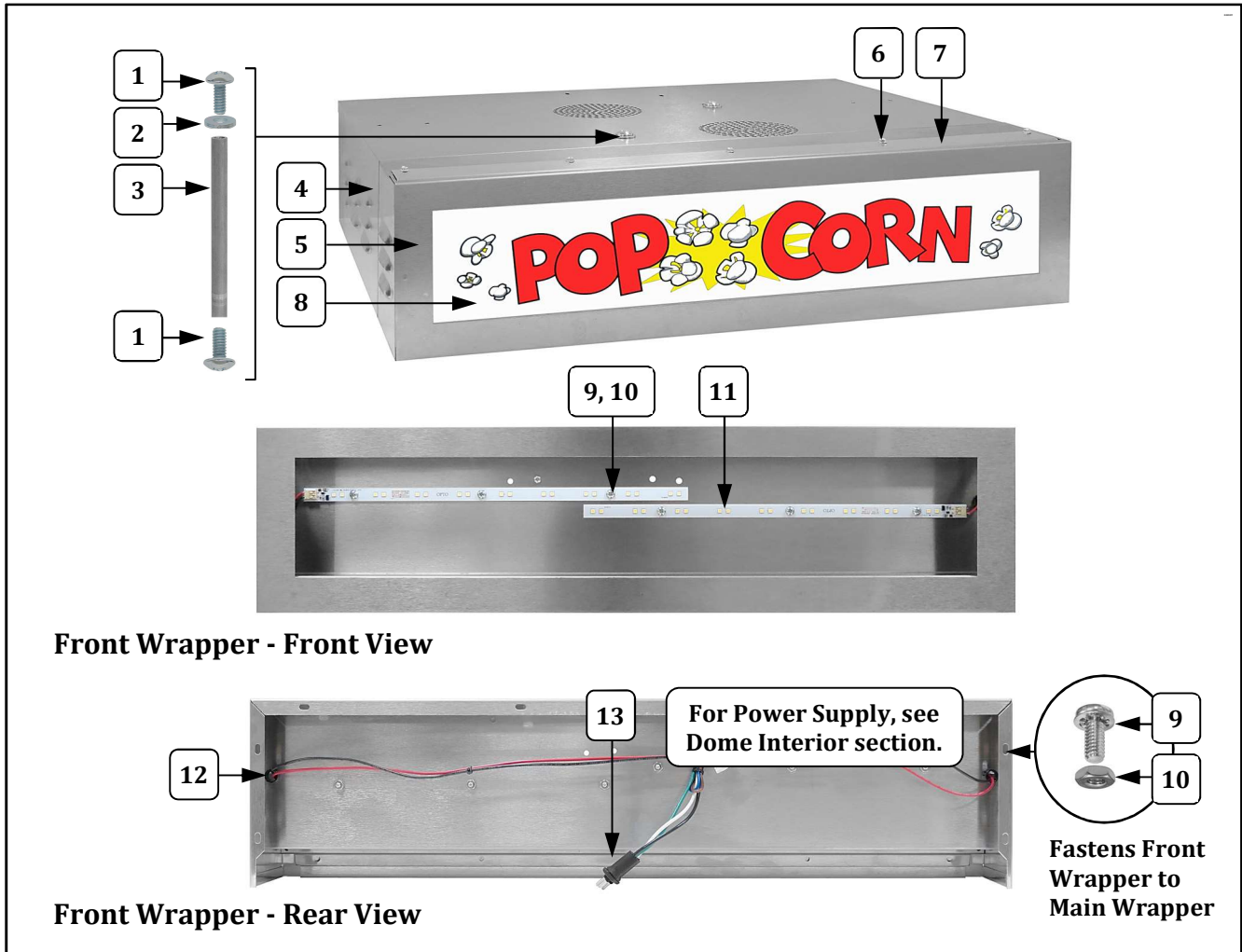

Item	Part Description	Part Number
		2003ST
1	5/16-18 X 5/8 PH TR (fastens dome)	46638
2	5/16 FLAT WASHER (fastens dome)	74134
3	DOMES SPACER	41526
4	MAIN WRAPPER	41794
5	FRONT WRAPPER	41797
6	8-32 X 3/8 SLT. (fastens support angle)	42044
7	DOMES SUPPORT ANGLE	41316
8	FRONT WRAPPER PLEX SIGN	41559
9	8-32 X 3/8 PH PAN	42227
10	8-32 HEX NUT	74149
11	LED STRIP COOL WHITE	55379
12	.500 IN SNAP BUSHING	47236
13	MOLDED PLUG	47726



## Lighted Sign Assembly – Molded Dome

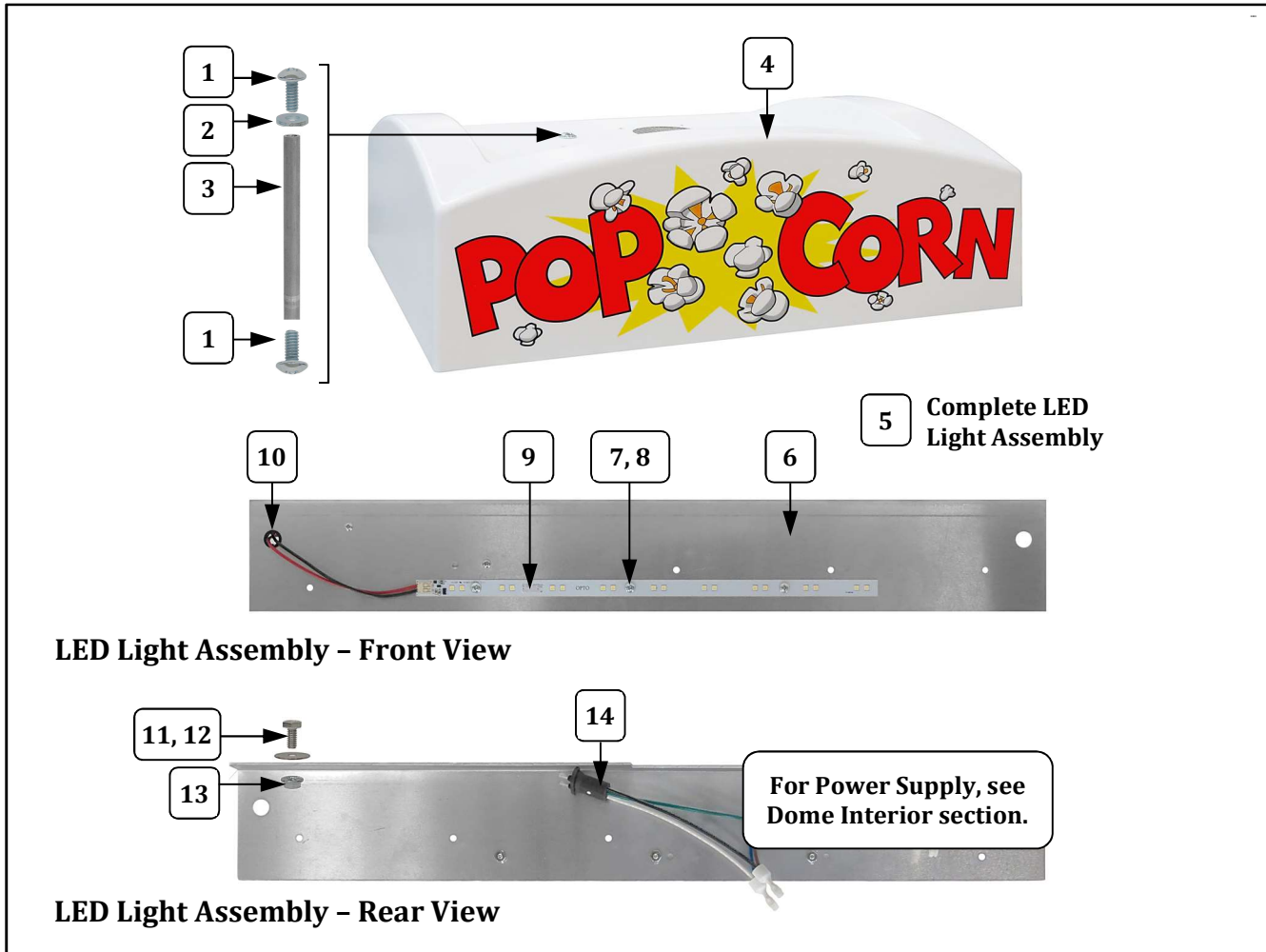

LED Light Assembly – Front View

LED Light Assembly – Rear View

Item	Part Description	Part Number
		2003
1	5/16-18 X 5/8 PH TR (fastens dome)	46638
2	5/16 FLAT WASHER (fastens dome)	74134
3	DOME SPACER	54014
4	20" X 28" MOLDED DOME	77001
5	LED LIGHT ASSEMBLY	77040
6	LED MOUNTING	55475
7	8-32 X 3/8 PH PAN (fastens LED strip)	42227
8	8-32 HEX NUT (fastens LED Strip)	74149
9	LED STRIP COOL WHITE	55379
10	.500 IN SNAP BUSHING	47236
11	1/4-20 X 1/2 HEX HD (fastens LED mount.)	14821
12	FENDER WASHER (fastens LED mount.)	82101
13	1/4-20 SERRATED NUT (fastens LED mount.)	46311
14	MOLDED PLUG	47726



# Safety Labels

**1**

**2**

**3**

**4**

**5**

**Unit Labels**

**Power Cord Label**

Item	Part Description	Part Number
		All Models
1	UNIVERSAL POPPER DECAL	41019
2	MAIN GROUND LABEL	42375
3	WARNING, SURFACE CONTACT	87087
4	CONDUIT WARNING LABEL	82840
5	WARNING LABEL CORD	68720

# Accessories

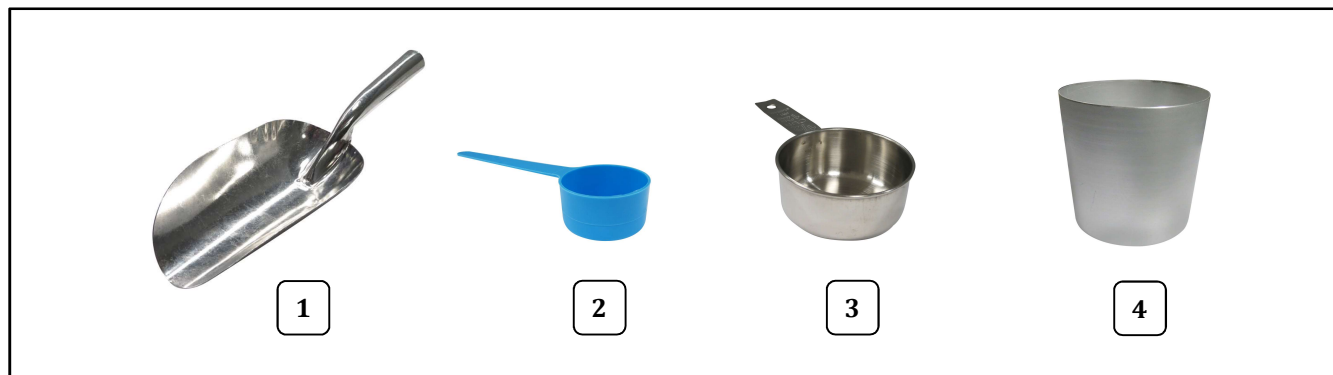

Item	Part Description	Part Number
		All Models
1	STAMPED ALUM SCOOP	2071
2	MEASURE 14.7CC	47679
3	MEASURE 1/2 CUP	47149
4	120Z VOL CORN MEA. BRIGHT	47148





## WARRANTY

Gold Medal Products Co. warrants to the original purchaser each item of its manufacture to be free of defects in workmanship and material under normal use and service. Gold Medal Products Co.'s obligation under this warranty is limited solely to repairing or replacing parts, f.o.b. Cincinnati, Ohio, which in its judgment are defective in workmanship or material and which are returned, freight prepaid, to its Cincinnati, Ohio factory or other designated point. Except for "Perishable Parts" on specific machines, the above warranty applies for a period of two (2) years from the date of original sale to the original purchaser of equipment when recommended operating instructions and maintenance procedures have been followed. These are packed with the machine. Parts warranty is two (2) years, labor is six (6) months.

THIS WARRANTY IS IN LIEU OF ALL OTHER WARRANTIES EXPRESSED OR IMPLIED, AND OF ALL OTHER OBLIGATIONS OR LIABILITIES ON OUR PART, INCLUDING THE IMPLIED WARRANTY OF MERCHANTABILITY. THERE ARE NO WARRANTIES WHICH EXTEND BEYOND THE DESCRIPTION ON THE FACE HEREOF. In no event shall Gold Medal Products Co. be liable for special, incidental or consequential damages. No claim under this warranty will be honored if the equipment covered has been misused, neglected, damaged in transit, or has been tampered with or changed in any way. No claim under this warranty shall be honored in the event that components in the unit at the time of the claim were not supplied or approved by Gold Medal Products Co. This warranty is effective only when electrical items have been properly attached to city utility lines only at proper voltages. This warranty is not transferable without the written consent of Gold Medal Products Co.

The term "Original Purchaser" as used in this warranty shall be deemed to mean that person, firm, association, or corporation who was billed by the GOLD MEDAL PRODUCTS CO., or their authorized distributor for the equipment.

THIS WARRANTY HAS NO EFFECT AND IS VOID UNLESS THE ORIGINAL PURCHASER FIRST CALLS GOLD MEDAL PRODUCTS CO. AT 1-800-543-0862 TO DISCUSS WITH OUR SERVICE REPRESENTATIVE THE EQUIPMENT PROBLEM, AND, IF NECESSARY, FOR INSTRUCTIONS CONCERNING THE REPAIR OR REPLACEMENT OF PARTS.

*NOTE: This equipment is manufactured and sold for commercial use only.*



**GOLD MEDAL<sup>®</sup> PRODUCTS CO.**

10700 Medallion Drive, Cincinnati, Ohio 45241-4807 USA

[gmpopcorn.com](http://gmpopcorn.com)

Phone: (800) 543-0862      Fax: (800) 542-1496  
(513) 769-7676              (513) 769-8500