



Instruction Manual

Astro Staging Cabinet

Model No. 2004, 2004SL, 2004SLN, 2008SL







GOLD MEDAL® PRODUCTS CO.



10700 Medallion Drive, Cincinnati, Ohio 45241-4807 USA





SAFETY PRECAUTIONS

	 DANGER
	<p>Machine must be properly grounded to prevent electrical shock to personnel. Failure to do so could result in serious injury, or death. DO NOT immerse any part of this equipment in water. DO NOT use excessive water when cleaning. Keep cord and plug off the ground and away from moisture. Always unplug the equipment before cleaning or servicing. Make sure all machine switches are in the OFF position before plugging the equipment into the receptacle.</p> <p style="text-align: right; font-size: small;">008_051514</p>

	 DANGER
	<p>Improper installation, adjustment, alteration, service, or maintenance can cause property damage, injury, or death. Any alterations to this equipment will void the warranty and may cause a dangerous condition. This appliance is not intended to be operated by means of an external timer or separate remote-control system. NEVER make alterations to this equipment. Read the Installation, Operating, and Maintenance Instructions thoroughly before installing, servicing, or operating this equipment.</p> <p style="text-align: right; font-size: small;">014_020416</p>

	 WARNING
	<p>To avoid burns, DO NOT touch heated surfaces. DO NOT place or leave objects in contact with heated surfaces.</p> <p style="text-align: right; font-size: small;">009_092414</p>



	 WARNING
	<p>ALWAYS wear safety glasses when servicing this equipment.</p> <p style="text-align: right; font-size: small;">010_010914</p>

	 WARNING
	<p>No user serviceable parts inside. Refer servicing to qualified service personnel.</p> <p style="text-align: right; font-size: small;">011_051514</p>

	 WARNING
	<p>Read and understand operator's manual and all other safety instructions before using this equipment. To order copies of the operator's manual go to gmpopcorn.com or write to Gold Medal Products Co., 10700 Medallion Drive, Cincinnati, OH 45241 USA 1-(800)-543-0862</p> <p style="text-align: right; font-size: small;">022_060215</p>



SAFETY PRECAUTIONS (continued)

	 WARNING
	DO NOT allow direct contact of this equipment by the public when used in food service locations. Only personnel trained and experienced in the equipment operation may operate this equipment. Carefully read all instructions before operation. 012_010914

	 WARNING
	This machine is NOT to be operated by minors. 007_010914

Note: Improvements are always being made to Gold Medal’s equipment. This information may not be the latest available for your purposes. It is critical that you call Gold Medal’s Technical Service Department at 1-800-543-0862 for any questions about your machine operations, replacement parts, or any service questions. (Gold Medal Products Co. does not assume any liability for injury due to careless handling and/or reckless operation of this equipment.) General images may be used in manual for reference only.



INSTALLATION INSTRUCTIONS

Inspection of Shipment

After unpacking, check thoroughly for any damage which may have occurred in transit. Claims should be filed immediately with the transportation company. The warranty does not cover damage that occurs in transit, or damage caused by abuse, or consequential damage due to the operation of this machine, since it is beyond our control (reference warranty in back of manual).

Manual

Read and understand the operator's manual and all other safety instructions before using this equipment. To order copies of the operator's manual go to gmpopcorn.com or write to Gold Medal Products Co., 10700 Medallion Drive, Cincinnati, OH 45241 USA 1-(800)-543-0862.

Model Description

The 2004 and 2008 Series are popcorn staging cabinets, with forced air popcorn crisper. This product is not intended for volatile food products. Options vary by Model (double sided door units have doors on both sides of cabinet).

2004: Large cabinet, swing out doors (one side), 2 shelves, and LED lighted sign.

2004SL: Large cabinet, sliding doors (one side), 2 shelves, and LED lighted sign.

2004SLN: Large cabinet, sliding doors (one side), 2 shelves, and LED Neon sign.

2008SL: Small cabinet, sliding doors (one side), 2 shelves, and LED lighted sign.

Setup

This unit has been tested at the factory.

1. Remove all packaging and tape prior to operation.
2. Place unit on a sturdy, level base for use, then place shelves on the shelf supports in unit.
3. Units with swing out doors - the door knobs are shipped facing the inside of the machine. Re-adjust knobs to face the outside of the machine.
4. For NSF compliance, set unit flush with counter and silicone caulk the 4 sides where frames meets counter top (see illustration below).
5. After setup, the unit should be cleaned prior to use (see Care and Cleaning section).

Bottom frame of
Warmer Unit

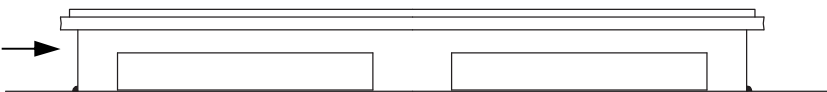



Silicone caulk 4 sides where frame meets counter top.

If equipped with Old Maid Pans, use minimal amount of caulk under pan openings to avoid interference with Old Mail Pans.

Electrical Requirements

The following power supply must be provided (reference unit Data Plate):

120 V~, 60 Hz

	 DANGER
	<p>Machine must be properly grounded to prevent electrical shock to personnel. Failure to do so could result in serious injury, or death. DO NOT immerse any part of this equipment in water. DO NOT use excessive water when cleaning. Keep cord and plug off the ground and away from moisture. Always unplug the equipment before cleaning or servicing. Make sure all machine switches are in the OFF position before plugging the equipment into the receptacle.</p> <p style="text-align: right; font-size: small;">008_051514</p>

A certified electrician must furnish sufficient power for proper machine operation and install any supplied receptacle. We recommend this equipment be on a dedicated and protected circuit. Failure to wire properly will void the warranty and may result in damage to the machine. It is Gold Medal Products Co.'s recommendation that this machine be plugged directly into a wall outlet. The use of extension cords is not recommended due to safety concerns, and may cause sacrificed and/or reduced performance. Make sure cord is located to prevent a trip hazard or unit upset.

Before You Plug In Machine

1. Make sure all machine switches are in the OFF position before plugging the equipment into the receptacle.
2. Make sure the wall outlet can accept the grounded plugs (where applicable) on the power supply cord.
3. The wall outlet must have the proper polarity. If in doubt, have a competent electrician inspect the outlet and correct if necessary.
4. **DO NOT** use a grounded to un-grounded receptacle adapter (where applicable).
5. Install the unit in a level position.

	 CAUTION
	<p>If the supply cord is damaged, it must be replaced by Gold Medal Products Co., its service agent or similarly qualified persons in order to avoid a hazard.</p> <p style="text-align: right; font-size: small;">039_080614</p>

OPERATING INSTRUCTIONS

Controls and Their Functions

LIGHT SWITCH

Two position, ON-OFF lighted rocker switch, provides power to the dome and cabinet lighting. The green switch light ON indicates there is power to the lighting.

LEFT/RIGHT WARMER SWITCHES

Two position, ON-OFF lighted rocker switch, provides power to the left hand or right hand crisper blower.

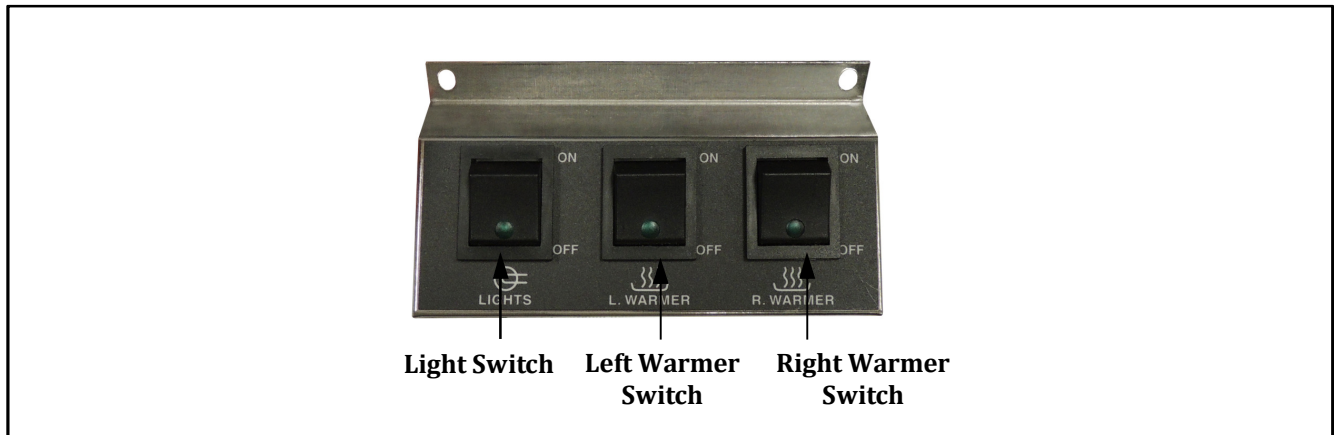

Operating Instructions

Follow the instructions below to operate the Staging Cabinet:

1. Turn the Light Switch ON to light up the cabinet interior and the dome sign.
2. Turn the Heater Switches ON for approximately 30 minutes prior to use for optimal pre-warming of cabinet.
3. Place product on the shelves of the cabinet. For best results, allow adequate space around product for air to circulate.



Care and Cleaning

	⚠ DANGER
	<p>Machine must be properly grounded to prevent electrical shock to personnel. DO NOT immerse in water. DO NOT clean appliance with a water jet. Always unplug the equipment before cleaning or servicing.</p> <p style="text-align: right;">025_111616</p>

	⚠ WARNING
	<p>To avoid burns, DO NOT touch heated surfaces. DO NOT place or leave objects in contact with heated surfaces.</p> <p style="text-align: right;">009_092414</p>

Good sanitation practice demands that all food preparation equipment be cleaned regularly (only use non-toxic, food grade cleaners). A clean looking, well-kept machine is one of the best ways of advertising your product.

Follow the directions below to clean and sanitize the unit each day after use.

1. With the machine OFF, unplug the unit and allow it to cool before attempting to clean.
2. Make sure to clean all of the pans (racks) in order to sanitize them before each use.
3. Remove bottom cabinet pans and clean out any stray debris.
4. The vertical air ducts, mounted on the inside of the cabinet, disassemble without tools for easy cleaning.
5. Clean unit with a soft cloth, dampened with soap and hot water.
6. Wipe the stainless steel parts with a clean cloth and cleaner designed for stainless steel, such as Gold Medal Watchdog Stainless Cleaner (Item No. 2088).



DO NOT use oven cleaners or abrasive materials as they will damage parts of the machine.



7. Clean the glass panels with glass cleaner. Gold Medal Watchdog Glass Cleaner (Item No. 2588) is recommended.

Ammonia cleaners will damage the plastic panels. Use only non-ammonia cleaners, such as Gold Medal Watchdog Glass Cleaner (Item No. 2588).





MAINTENANCE INSTRUCTIONS

	 DANGER
	<p>Machine must be properly grounded to prevent electrical shock to personnel. Failure to do so could result in serious injury, or death. DO NOT immerse any part of this equipment in water. DO NOT use excessive water when cleaning. Keep cord and plug off the ground and away from moisture. Always unplug the equipment before cleaning or servicing. Make sure all machine switches are in the OFF position before plugging the equipment into the receptacle.</p> <p style="text-align: right; font-size: small;">008_051514</p>

	 DANGER
	<p>Improper installation, adjustment, alteration, service, or maintenance can cause property damage, injury, or death. Any alterations to this equipment will void the warranty and may cause a dangerous condition. This appliance is not intended to be operated by means of an external timer or separate remote-control system. NEVER make alterations to this equipment. Read the Installation, Operating, and Maintenance Instructions thoroughly before installing, servicing, or operating this equipment.</p> <p style="text-align: right; font-size: small;">014_020416</p>

	 WARNING
	<p>No user serviceable parts inside. Refer servicing to qualified service personnel.</p> <p style="text-align: right; font-size: small;">011_051514</p>

	 CAUTION
	<p>THE FOLLOWING SECTIONS OF THIS MANUAL ARE INTENDED ONLY FOR QUALIFIED SERVICE PERSONNEL WHO ARE FAMILIAR WITH ELECTRICAL EQUIPMENT. THESE ARE NOT INTENDED FOR THE OPERATOR.</p> <p style="text-align: right; font-size: small;">027_010914</p>



ORDERING SPARE PARTS

1. Identify the needed part by checking it against the photos, illustrations, and/or parts list. (General images may be used in manual for reference only.)
2. Use only approved replacement parts when servicing this unit.
3. When ordering, please include part number, part name, and quantity needed.
4. Please include your model number, serial number, and date of manufacture (located on the machine nameplate/data plate) with your order.
5. Address all parts orders to:

Parts Department
Gold Medal Products Co.
10700 Medallion Drive
Cincinnati, Ohio 45241-4807

Or, place orders by phone or online:

Phone: (800) 543-0862
(513) 769-7676
Fax: (800) 542-1496
(513) 769-8500
E-mail: info@gmpopcorn.com
Web Page: gmpopcorn.com



Replacing Broken Glass

Broken glass panels can be easily replaced. Gold Medal Products Co. does not ship glass. It can be obtained from a local glass shop, always purchase tempered glass.

GLASS DIMENSIONS (Height x Width x Thickness)

Model 2004 Series

Front Glass: 32 3/16" X 31 1/16" X 1/8

Side Glass: 32 3/16" X 23 1/16" X 1/8

Model 2008SL

Front Glass: 32 3/16" X 31 1/16" X 1/8

Side Glass: 32 3/16" X 14 9/16" X 1/8

1. Turn machine OFF, unplug unit and allow it to cool before attempting to replace glass.
2. Remove all loose pieces of glass.
3. Remove all rigid glass channels from around glass to be replaced; set channels aside for reuse.
4. Carefully remove the rest of the broken glass.
5. Apply decals (if desired) to new glass panel.
6. Slide rigid glass channels over the exposed sides and bottom of new glass panel.
7. Fasten new glass panel in machine with the existing glass strips. (On some units, the front and side glass slide under top and is then lowered into the bottom channel.)



Cabinet Assembly – Parts Breakdown

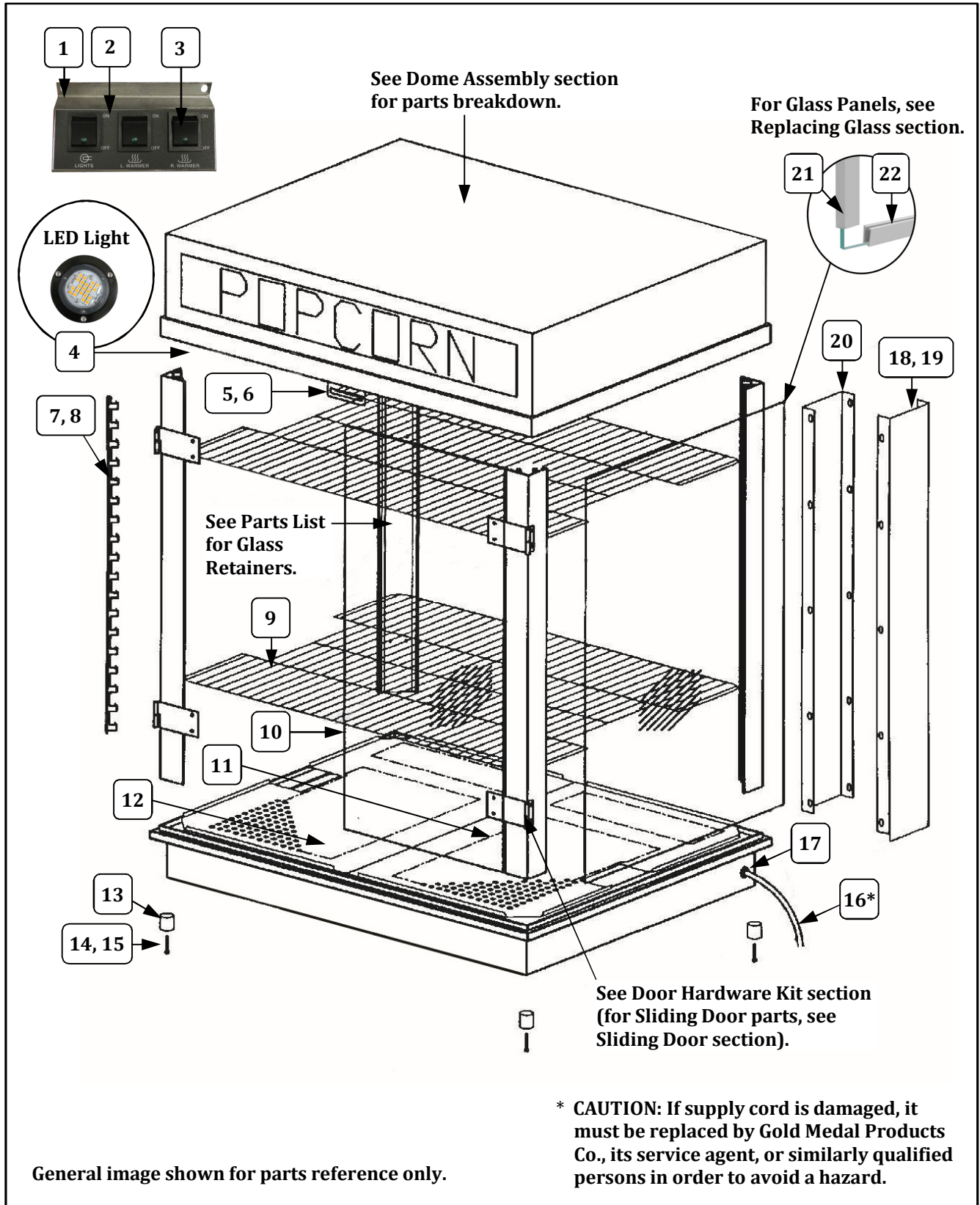



Cabinet Assembly – Parts List

Item	Part Description	Part Number		
		2004	2004SL, 2004SLN	2008SL
1	ROCKER SW 3 HOLE (switch box)	17473	17473	17473
2	ROCKER SWITCH LABEL 3 HL	61986	61986	61986
3	SWITCH, LIGHTED ROCKER GR	42798	42798	42798
4	LED REPLACEMENT (in cabinet ceiling)	100544	100544	100544
5	MAGNETIC CATCH BRACKET	41340		
6	MAGNETIC CATCH	47561		
7	SHELF SUPPORT LH 1617/TS	16056	16056	16056
8	SHELF SUPPORT RH 1617/TS	16057	16057	16057
9	SHELF	17008	17008	16643
10	DOOR 15.25 X 31.28 X .22	40352		
11	CORN PAN RH	40296	40296	16653
12	CORN PAN LH	40297	40297	16654
13	RUBBER FOOT CASE BOTTOM	41282	41282	41282
14	10-24 x 1 1/8 PAN HEAD	47128	47128	47128
15	10-24 SERRATED LOCK NUT	49363	49363	49363
16*	LEAD-IN CORD 20 AMP PLUG	47580	47580	
	LEAD-IN CORD 15 AMP PLUG			22038
17	STRAIN RELIEF SR-31-2	41735	41735	41735
18	DUCT PANEL LG	40292	40292	40292
19	DUCT BRACKET	40177	40177	40177
20	DUCT COVER LG	40293	40293	40293
21	GLASS CHAN 31 27/32 (for sides of front and side glass panels)	41858	41858	41858
22	GLASS CHAN 22 7/8 (for bottom of side glass panels, cut as needed)	47694	47694	47694

Glass Retainers

Item	Part Description	Part Number
		All Models
	GLASS RETAINER FRONT (2 required)	41765
	GLASS RETAINER REAR (2 required)	41766



Door Hardware Kits – Individual Component Breakdown

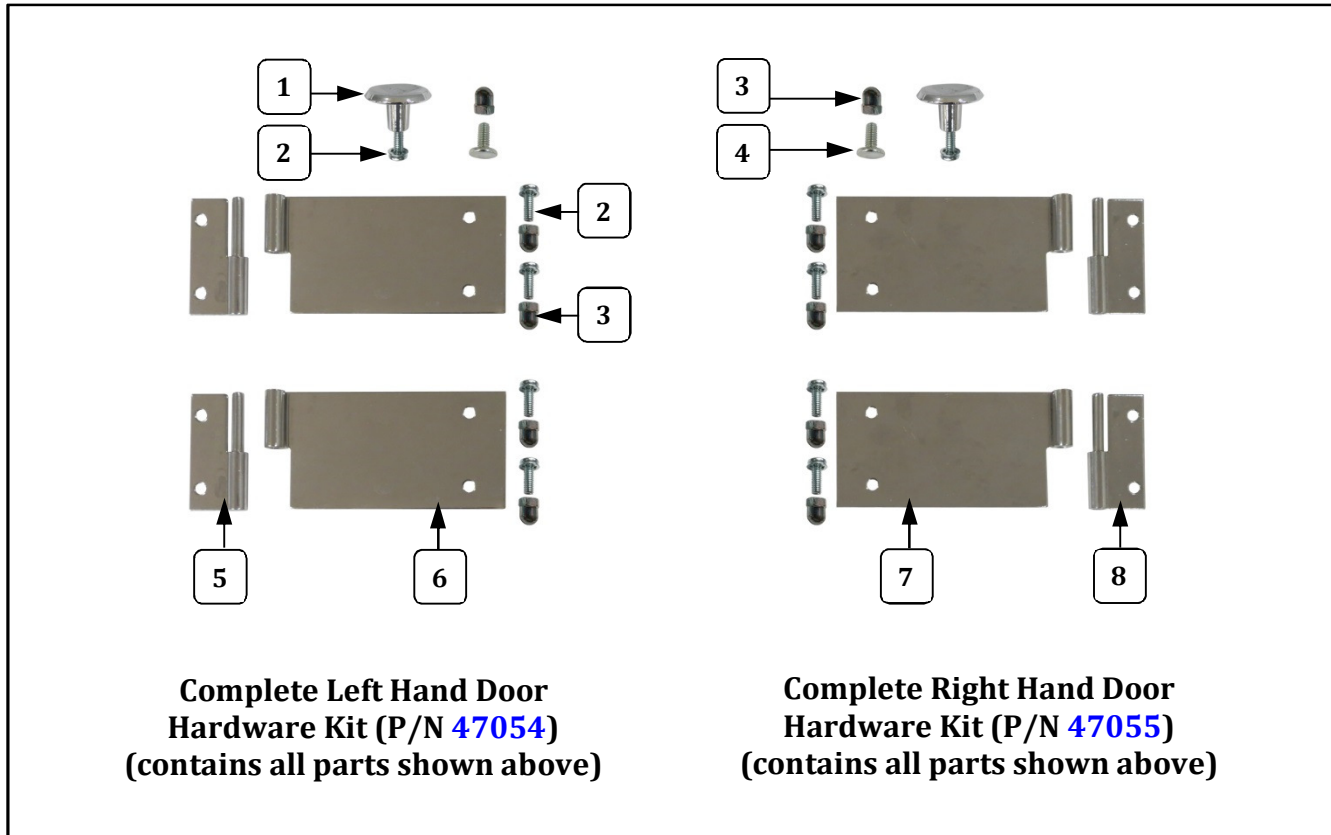

Item	Part Description	Part Number	
		47054	47055
1	DOOR KNOB	41013	41013
2	8-32 X 1/2 SCREWS PH PAN W/SEMS	47124	47124
3	ACORN NUT #8-32	47702	47702
4	TEE BOLT	75267	75267
5	MALE HINGE SHORT LEFT	41349	
6	FEMALE HINGE LONG LEFT	41352	
7	FEMALE HINGE LONG RIGHT		41351
8	MALE HINGE SHORT RIGHT		41350



Sliding Door Assembly – Parts List

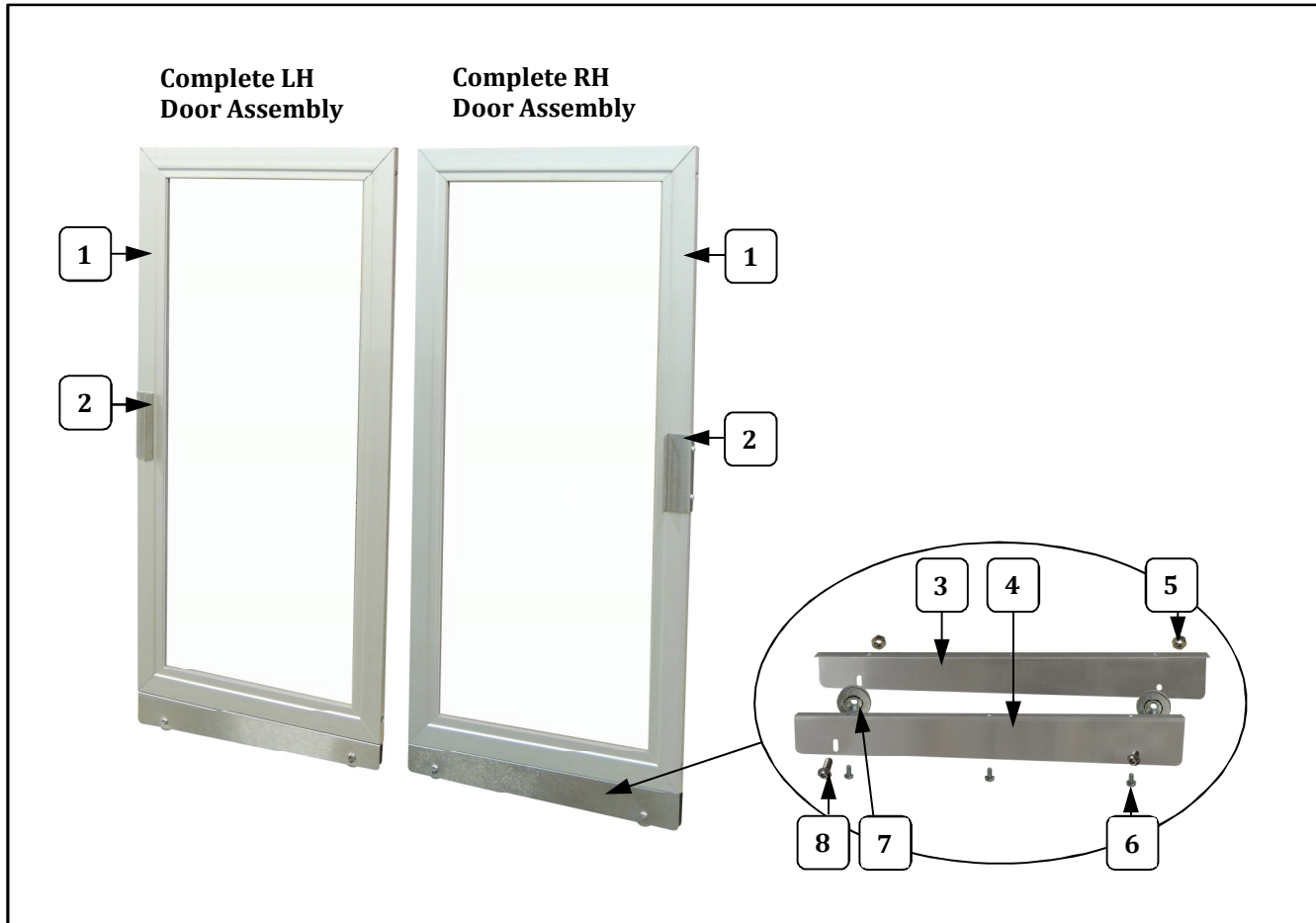

Item	Part Description	Part Number	
		LH Door Assy.	RH Door Assy.
	DOOR ASSY. COMP. (includes items below)	16255	16254
1	DOOR FRAME WITH GLASS	16076	16076
2	HANDLE, SLIDING DOOR	16252	16252
3	ROLLER SUPPORT REAR	16235	16084
4	ROLLER SUPPORT FRONT	16236	16083
5	1/4-20 HEX JAM NUT, 18-8	41451	41451
6	8-32 X 1/2 PH PAN W/SEMS	47124	47124
7	ROLLER, BALL BEARING	16092	16092
8	1/4-20 X 5/8 BT HD SCREW	16070	16070

Sliding Door Frame Assembly - Parts List

Item	Part Description	Part Number
	POLYETHYLENE TAPE (used between top of door frame and unit) (not shown)	16234
	DOOR FRAME WELD ASSEMBLY (not shown)	16240
	DOOR TRACK WELDED ASSY (not shown)	16245



Cabinet Motor Plate View

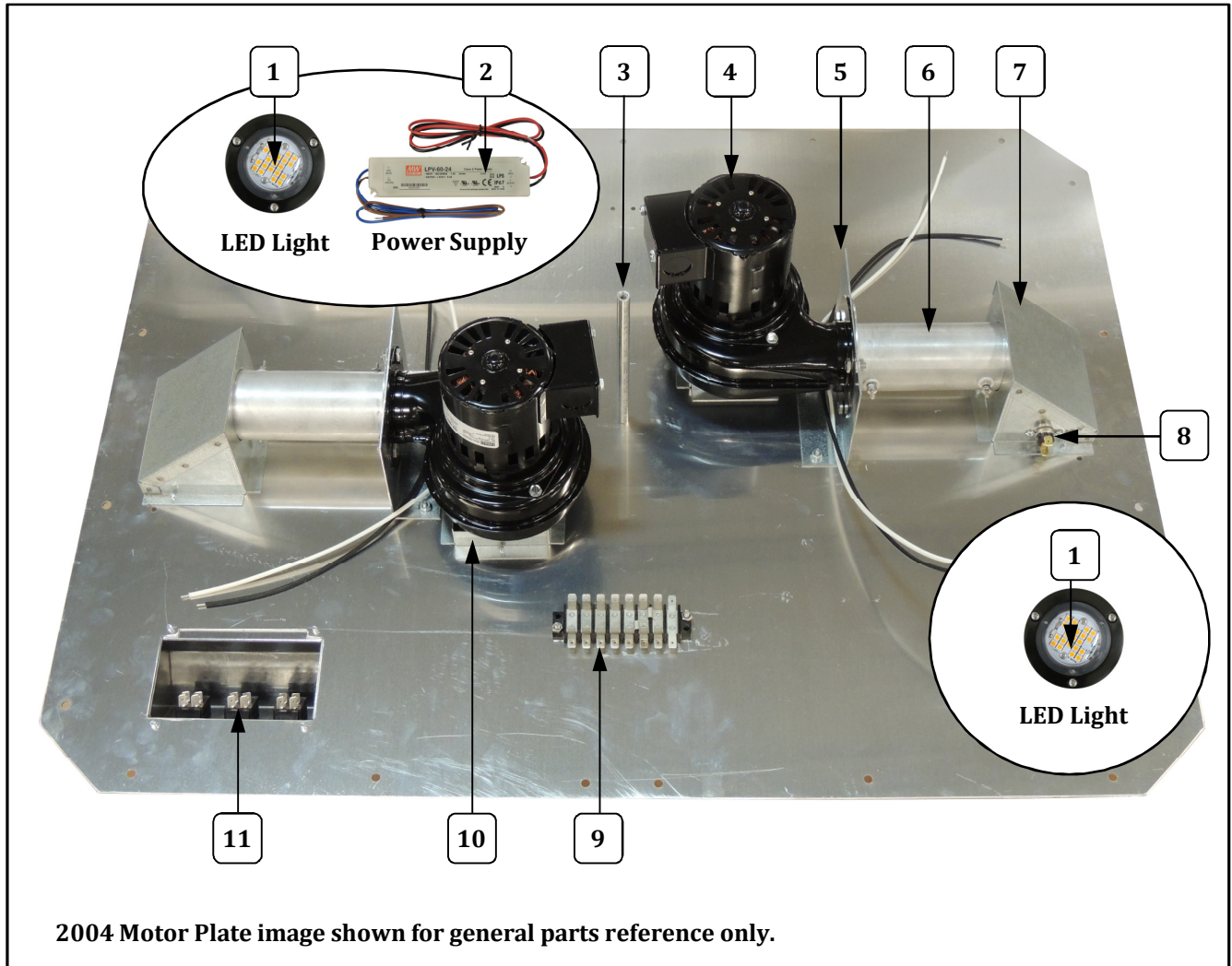

2004 Motor Plate image shown for general parts reference only.

Item	Part Description	Part Number		
		2004, 2004SL	2004SLN	2008SL
1	LED REPLACEMENT	100544	100544	100544
2	POWER SUPPLY 24VDC 60W	55586		55586
	POWER SUPPLY 24VDC 20W (for LED Light, see Neon Dome section for power supply for sign)		55394	
3	DOME SPACER 6 9/16	41526	41526	41526
4	BLOWER	40254	40254	40254
5	BLOWER BRACKET	40145	40145	40145
6	NOZZLE HEATER, 120V 850W	40153	40153	40153
7	EXHAUST BOX, WELD ASSY	40185	40185	40185
8	HIGH LIMIT, THERMOSTAT	79058	79058	79058
9	TERMINAL BLOCK, 8 POS	47208	47208	47208
10	INTAKE COVER (2 required for each blower)	40184	40184	40184
11	SWITCH, LIGHTED ROCKER GR	42798	42798	42798



LED Lighted Sign Dome Assembly

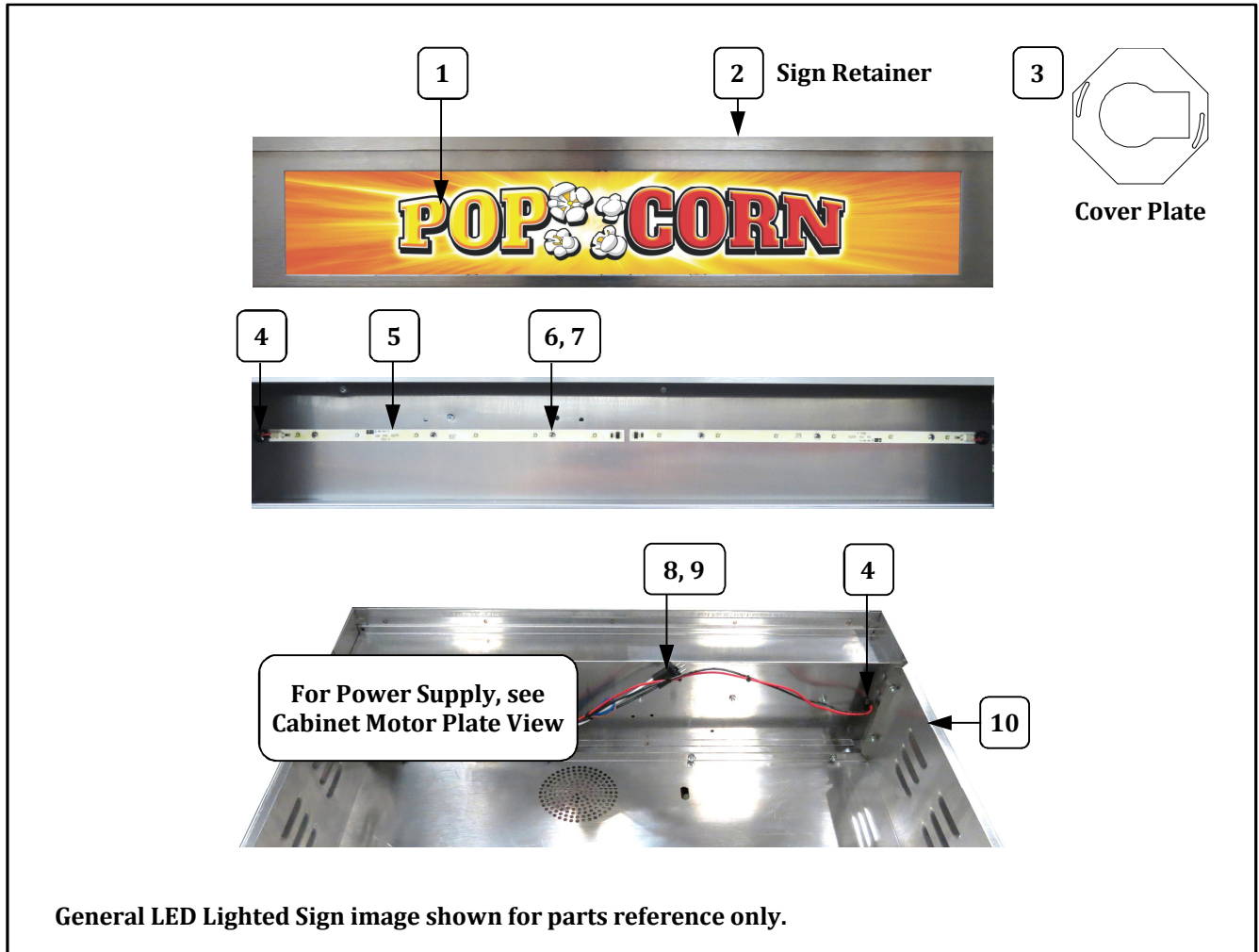

General LED Lighted Sign image shown for parts reference only.

Item	Part Description	Part Number	
		2004, 2004SL	2008SL
	ASSY, DOME COMPLETE	40198	16656
1	POPCORN SIGN	111871	111871
2	SUPPORT ANGLE, DOME (Sign Retainer)	41503	41503
3	COVER PLATE	40351	40351
4	BUSHING, SNAP .500 IN	47236	47236
5	LED STRIP COOL WHITE	55379	55379
6	8-32 X 3/8 PH PAN W/SEMS	42227	42227
7	8-32 SERRATED FLANGE NUT	61151	61151
8	MOLDED PLUG	47726	47726
9	MOLDED RECEPTACLE (not shown)	41712	41712
10	DOME WELD ASSEMBLY	40278	16650



LED Neon Dome Assembly

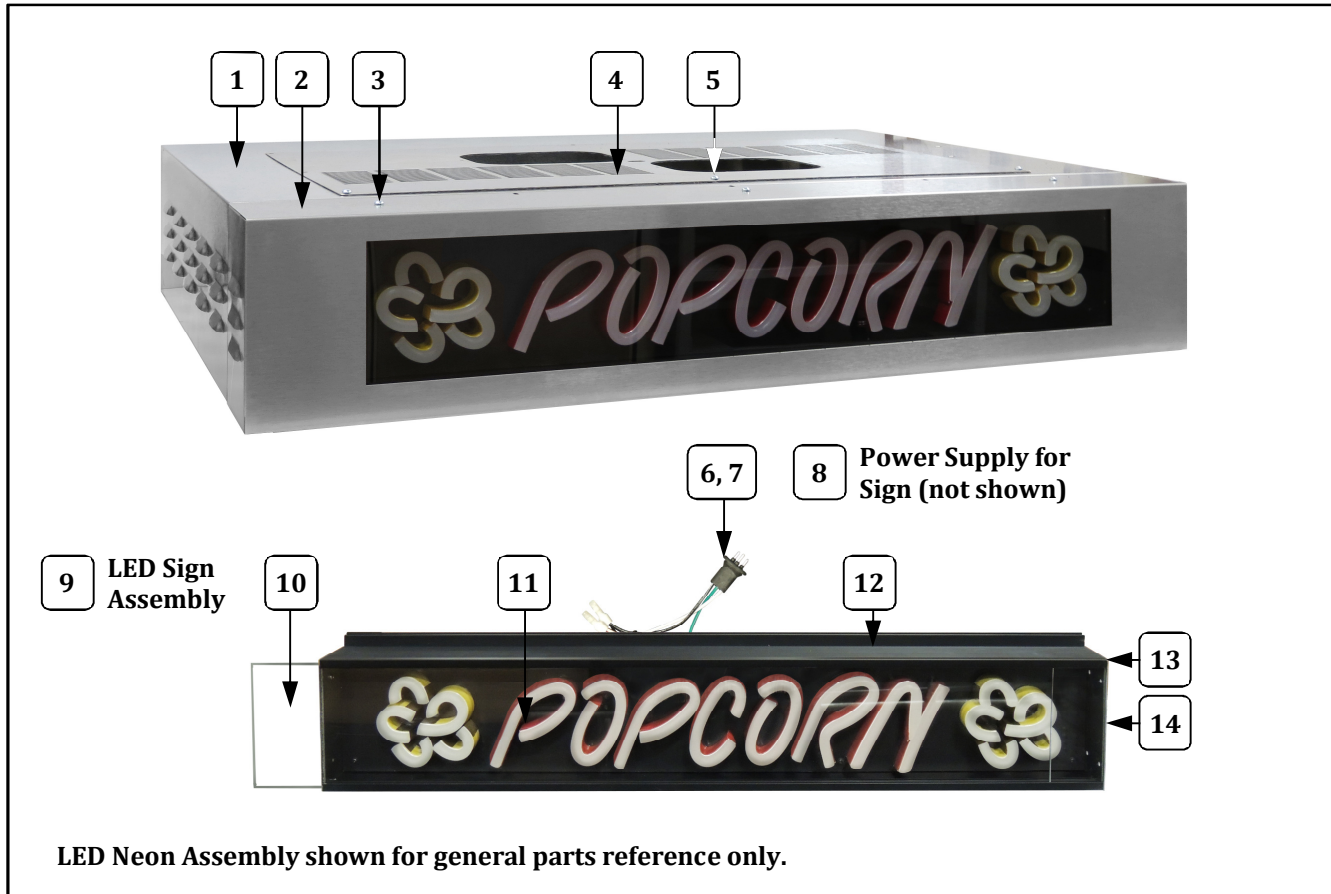

Item	Part Description	Part Number
		2004SLN
	DOME ASSY W/ SIGN & TRANS (complete dome assembly)	16328
1	DOME MAIN WRAPPER	16030
2	FRONT WRAPPER WELD ASSEMBLY	47232
3	8-32X1/2 PAN HD PH (fastens neon sign)	74147
4	INSPECTION PLATE	40375
5	8-32X3/8 PAN HD PH (fastens inspection plate)	74141
6	MOLDED PLUG	47726
7	MOLDED RECEPTACLE (not shown)	47727
8	POWER SUPPLY, 12VDC	55231
9	LED SIGN ASSY, 30 INCH (includes items listed below)	67524
10	COVER, 30 NEON SIGN	67418
11	LED POPCORN SIGN	69707
12	ALUM EXTRUSION,29.875"LG	67439
13	8-32 X 3/8 SLT. HWH M/S	42044
14	END CAP	67420



Wiring Diagram

Model No. 2004, 2004SL, 2004SLN

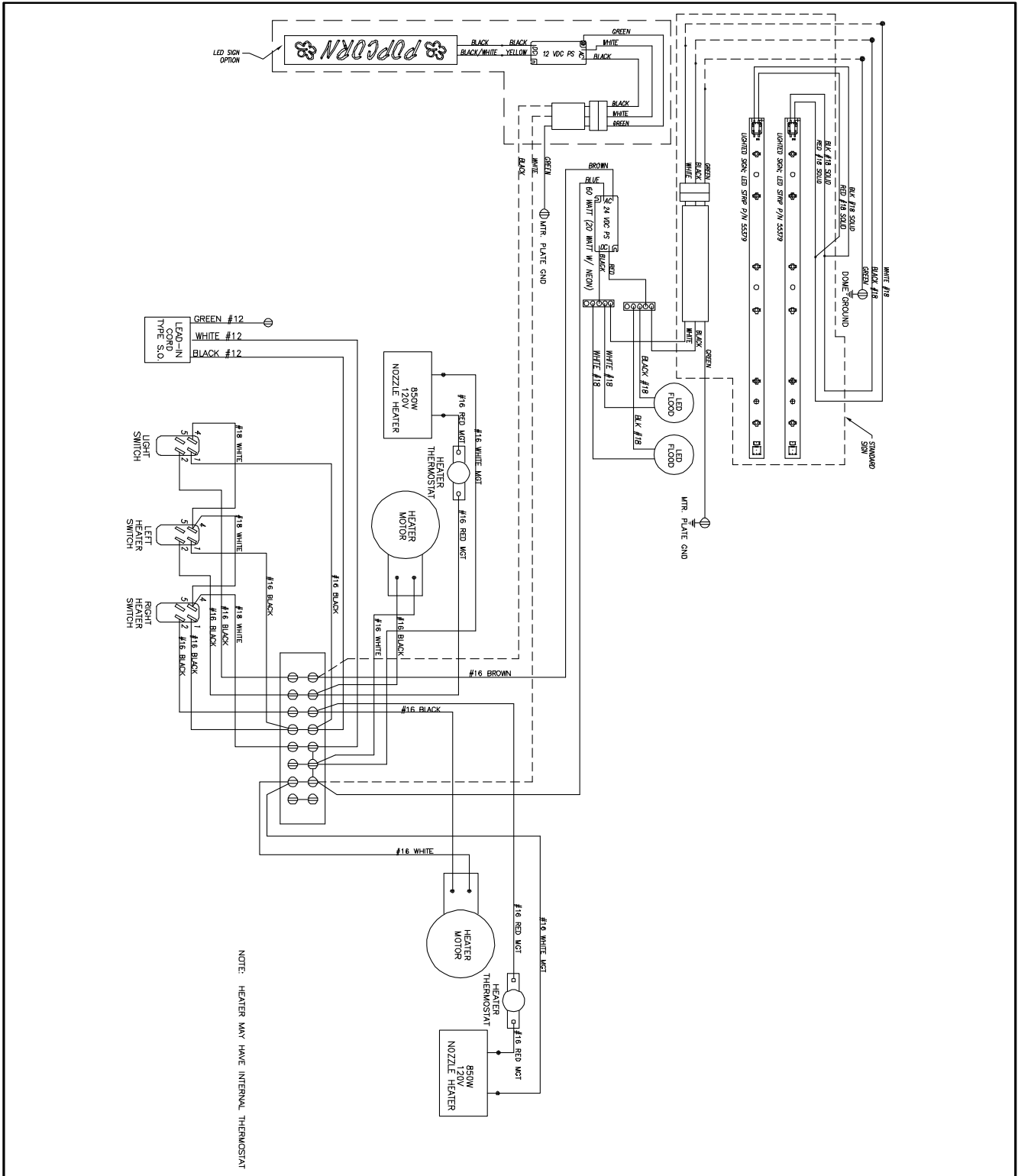



Model No. 2008SL

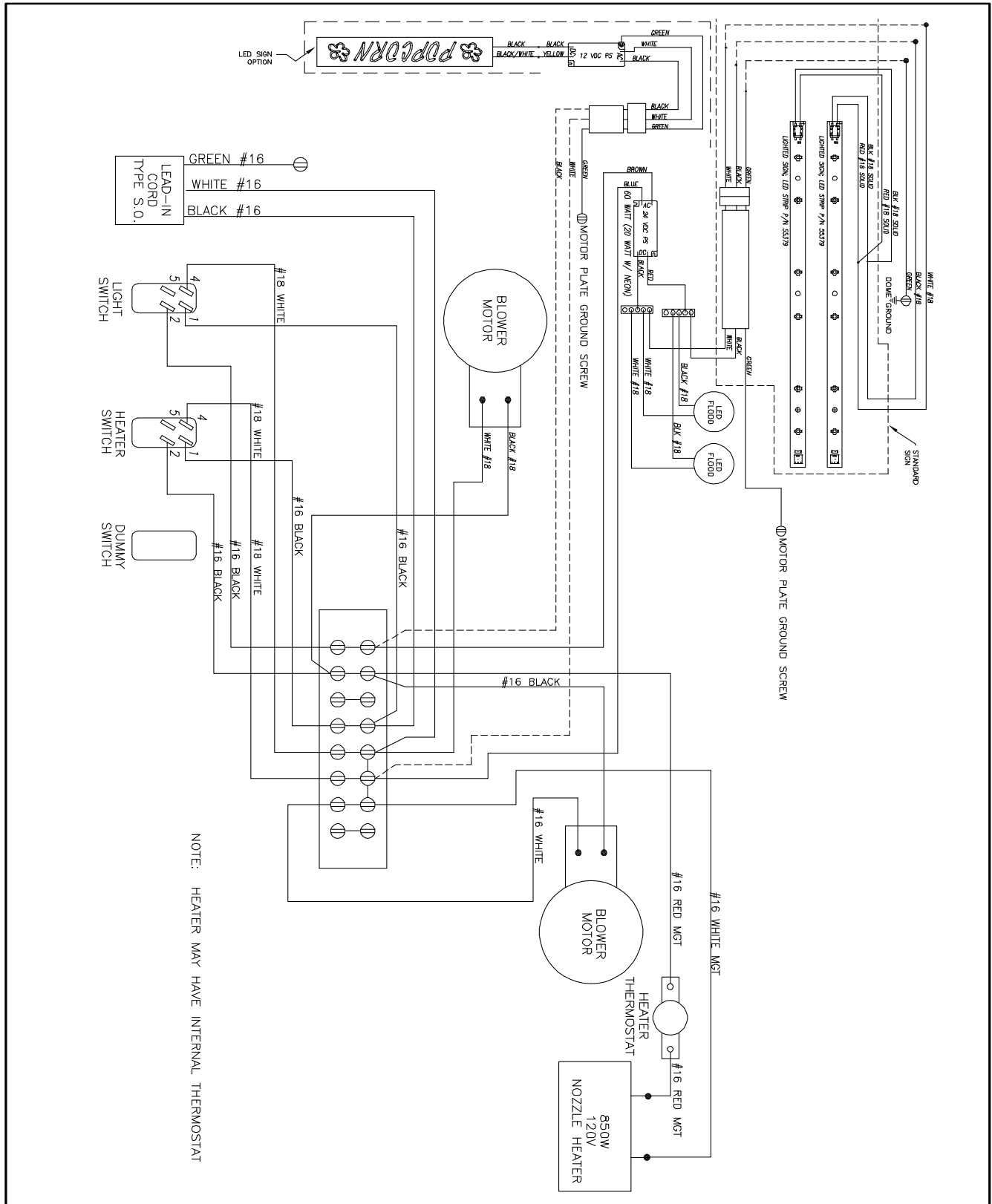



WARRANTY

Gold Medal Products Co. warrants to the original purchaser each item of its manufacture to be free of defects in workmanship and material under normal use and service. Gold Medal Products Co.'s obligation under this warranty is limited solely to repairing or replacing parts, f.o.b. Cincinnati, Ohio, which in its judgment are defective in workmanship or material and which are returned, freight prepaid, to its Cincinnati, Ohio factory or other designated point. Except for "Perishable Parts" on specific machines, the above warranty applies for a period of two (2) years from the date of original sale to the original purchaser of equipment when recommended operating instructions and maintenance procedures have been followed. These are packed with the machine. Parts warranty is two (2) years, labor is six (6) months.

THIS WARRANTY IS IN LIEU OF ALL OTHER WARRANTIES EXPRESSED OR IMPLIED, AND OF ALL OTHER OBLIGATIONS OR LIABILITIES ON OUR PART, INCLUDING THE IMPLIED WARRANTY OF MERCHANTABILITY. THERE ARE NO WARRANTIES WHICH EXTEND BEYOND THE DESCRIPTION ON THE FACE HEREOF. In no event shall Gold Medal Products Co. be liable for special, incidental or consequential damages. No claim under this warranty will be honored if the equipment covered has been misused, neglected, damaged in transit, or has been tampered with or changed in any way. No claim under this warranty shall be honored in the event that components in the unit at the time of the claim were not supplied or approved by Gold Medal Products Co. This warranty is effective only when electrical items have been properly attached to city utility lines only at proper voltages. This warranty is not transferable without the written consent of Gold Medal Products Co.

The term "Original Purchaser" as used in this warranty shall be deemed to mean that person, firm, association, or corporation who was billed by the GOLD MEDAL PRODUCTS CO., or their authorized distributor for the equipment.

THIS WARRANTY HAS NO EFFECT AND IS VOID UNLESS THE ORIGINAL PURCHASER FIRST CALLS GOLD MEDAL PRODUCTS CO. AT 1-800-543-0862 TO DISCUSS WITH OUR SERVICE REPRESENTATIVE THE EQUIPMENT PROBLEM, AND, IF NECESSARY, FOR INSTRUCTIONS CONCERNING THE REPAIR OR REPLACEMENT OF PARTS.

NOTE: This equipment is manufactured and sold for commercial use only.



GOLD MEDAL[®] PRODUCTS CO.

10700 Medallion Drive, Cincinnati, Ohio 45241-4807 USA

gmpopcorn.com

Phone: (800) 543-0862 Fax: (800) 542-1496
(513) 769-7676 (513) 769-8500