



Instruction Manual

12" Deluxe Servalot

Model No. 2186ST, 2188ST







GOLD MEDAL[®] PRODUCTS CO.



10700 Medallion Drive, Cincinnati, Ohio 45241-4807 USA







SAFETY PRECAUTIONS

	 DANGER
	<p>Machine must be properly grounded to prevent electrical shock to personnel. Failure to do so could result in serious injury, or death. DO NOT immerse any part of this equipment in water. DO NOT use excessive water when cleaning. Keep cord and plug off the ground and away from moisture. Always unplug the equipment before cleaning or servicing. Make sure all machine switches are in the OFF position before plugging the equipment into the receptacle.</p> <p style="text-align: right; font-size: small;">008_051514</p>

	 DANGER
	<p>Improper installation, adjustment, alteration, service, or maintenance can cause property damage, injury, or death. Any alterations to this equipment will void the warranty and may cause a dangerous condition. This appliance is not intended to be operated by means of an external timer or separate remote-control system. NEVER make alterations to this equipment. Read the Installation, Operating, and Maintenance Instructions thoroughly before installing, servicing, or operating this equipment.</p> <p style="text-align: right; font-size: small;">014_020416</p>

	 WARNING
	<p>To avoid burns, DO NOT touch heated surfaces. DO NOT place or leave objects in contact with heated surfaces.</p> <p style="text-align: right; font-size: small;">009_092414</p>



	 WARNING
	<p>ALWAYS wear safety glasses when servicing this equipment.</p> <p style="text-align: right; font-size: small;">010_010914</p>

	 WARNING
	<p>No user serviceable parts inside. Refer servicing to qualified service personnel.</p> <p style="text-align: right; font-size: small;">011_051514</p>

	 WARNING
	<p>Read and understand operator's manual and all other safety instructions before using this equipment. To order copies of the operator's manual go to gmpopcorn.com or write to Gold Medal Products Co., 10700 Medallion Drive, Cincinnati, OH 45241 USA 1-(800)-543-0862</p> <p style="text-align: right; font-size: small;">022_060215</p>



SAFETY PRECAUTIONS (continued)

	 WARNING
	DO NOT allow direct contact of this equipment by the public when used in food service locations. Only personnel trained and experienced in the equipment operation may operate this equipment. Carefully read all instructions before operation. 012_010914

	 WARNING
	This machine is NOT to be operated by minors. 007_010914

Note: Improvements are always being made to Gold Medal's equipment. This information may not be the latest available for your purposes. It is critical that you call Gold Medal's Technical Service Department at 1-800-543-0862 for any questions about your machine operations, replacement parts, or any service questions. (Gold Medal Products Co. does not assume any liability for injury due to careless handling and/or reckless operation of this equipment.)



INSTALLATION INSTRUCTIONS

Inspection of Shipment

After unpacking, check thoroughly for any damage which may have occurred in transit. Claims should be filed immediately with the transportation company. The warranty does not cover damage that occurs in transit, or damage caused by abuse, or consequential damage due to the operation of this machine, since it is beyond our control (reference warranty in back of manual).

Manual

Read and understand the operator's manual and all other safety instructions before using this equipment. To order copies of the operator's manual go to gmpopcorn.com or write to Gold Medal Products Co., 10700 Medallion Drive, Cincinnati, OH 45241 USA 1-(800)-543-0862.

Model Description

2186ST: 12" Deluxe Servalot with a Nachos Decal.

2188ST: 12" Deluxe Servalot with Popcorn Decal.

Items Included with this Unit



Aluminum Scoop



Black Crutch Tips

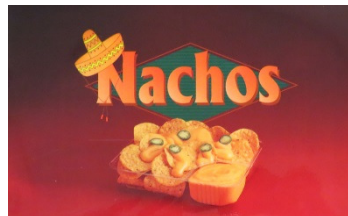

Nachos Decal
(Model 2186ST)



Popcorn Bowl Decal
(Model 2188ST)



Setup

This unit has been tested at the factory.

1. Remove all packaging and tape prior to operation.
2. Place unit on a sturdy, level base for use.
3. Unit has 4 glide feet preinstalled at the factory. Install a Black Crutch Tip on each foot. Firmly push crutch tip over glide until it covers glide entirely.
4. **Decal Installation:** A decal is shipped with the warmer unit; install decal at top of unit on customer side.
 - a. Before installation, clean area with a mild soap and water, then thoroughly dry with a soft cloth.
 - b. Put decal in place, then remove backing a bit at a time while using a squeegee to smooth decal as applied.
 - c. If air bubbles occur, puncture them with a small pin and smooth down with a squeegee.
5. After setup, the unit should be cleaned prior to use (see Care and Cleaning section of this manual).





Electrical Requirements

The following power supply must be provided:

2186ST: 120 V~, 61 W, 60 Hz



2188ST: 120 V~, 90 W, 60 Hz

	 DANGER
	<p>Machine must be properly grounded to prevent electrical shock to personnel. Failure to do so could result in serious injury, or death. DO NOT immerse any part of this equipment in water. DO NOT use excessive water when cleaning. Keep cord and plug off the ground and away from moisture. Always unplug the equipment before cleaning or servicing. Make sure all machine switches are in the OFF position before plugging the equipment into the receptacle.</p> <p style="text-align: right; font-size: small;">008_051514</p>

A certified electrician must furnish sufficient power for proper machine operation and install any supplied receptacle. We recommend this equipment be on a dedicated and protected circuit. Failure to wire properly will void the warranty and may result in damage to the machine. It is Gold Medal Products Co.'s recommendation that this machine be plugged directly into a wall outlet. The use of extension cords is not recommended due to safety concerns, and may cause sacrificed and/or reduced performance. Make sure cord is located to prevent a trip hazard or unit upset.

Before You Plug In Machine

1. Make sure all machine switches are OFF before plugging equipment into receptacle.
2. Make sure wall outlet can accept the grounded plugs (where applicable) on the power supply cord.
3. The wall outlet must have the proper polarity. If in doubt, have a competent electrician inspect the outlet and correct if necessary.
4. **DO NOT** use a grounded to un-grounded receptacle adapter (where applicable).
5. Install unit in a level position.

	 CAUTION
	<p>If the supply cord is damaged, it must be replaced by Gold Medal Products Co., its service agent or similarly qualified persons in order to avoid a hazard.</p> <p style="text-align: right; font-size: small;">039_080614</p>



OPERATING INSTRUCTIONS

Controls and Their Functions

POWER SWITCH

Two position, ON/OFF lighted rocker switch - supplies power to the light and to heat element.

The heat element on the underside of the warmer pan keeps popcorn/nachos warm and fresh in the cabinet. The yellow shatterproof light bulb also warms the product while lighting the top portion of the cabinet.

Caution: To replace the 11 watt yellow light bulb, use a maximum 11 watt, shatterproof bulb (the replacement bulb **MUST** be shatterproof).



Power Switch

Operating Instructions

To load the Servalot, remove the lid and pour in the food product. For best display, fill warmer 3/4 full.



Care and Cleaning

	⚠ DANGER
	<p>Machine must be properly grounded to prevent electrical shock to personnel. DO NOT immerse in water. Always unplug the equipment before cleaning or servicing.</p> <p style="text-align: right;">025_020314</p>

	⚠ WARNING
	<p>To avoid burns, DO NOT touch heated surfaces. DO NOT place or leave objects in contact with heated surfaces.</p> <p style="text-align: right;">009_092414</p>

Good sanitation practice demands that all food preparation equipment be cleaned regularly (only use non-toxic, food grade cleaners). A clean looking, well-kept machine is one of the best ways of advertising your product.

Follow the directions below to clean and sanitize unit each day after use.

1. Turn machine OFF, unplug unit and allow it to cool before attempting to clean.
2. Use a damp cloth to remove all dirt and grease spots.

Wipe stainless steel parts with a clean cloth and cleaner designed for stainless steel, such as Gold Medal Watchdog Stainless Cleaner (Item No. 2088).



DO NOT use oven cleaners or abrasive materials as they will damage parts of machine.



3. Clean plastic panels with glass cleaner. Gold Medal Watchdog Glass Cleaner (Item No. 2588) is recommended.



Ammonia cleaners will damage plastic panels. Use only non-ammonia cleaners, such as Gold Medal Watchdog Glass Cleaner (Item No. 2588).





MAINTENANCE INSTRUCTIONS

	 DANGER
	<p>Machine must be properly grounded to prevent electrical shock to personnel. Failure to do so could result in serious injury, or death. DO NOT immerse any part of this equipment in water. DO NOT use excessive water when cleaning. Keep cord and plug off the ground and away from moisture. Always unplug the equipment before cleaning or servicing. Make sure all machine switches are in the OFF position before plugging the equipment into the receptacle.</p> <p style="text-align: right; font-size: small;">008_051514</p>

	 DANGER
	<p>Improper installation, adjustment, alteration, service, or maintenance can cause property damage, injury, or death. Any alterations to this equipment will void the warranty and may cause a dangerous condition. This appliance is not intended to be operated by means of an external timer or separate remote-control system. NEVER make alterations to this equipment. Read the Installation, Operating, and Maintenance Instructions thoroughly before installing, servicing, or operating this equipment.</p> <p style="text-align: right; font-size: small;">014_020416</p>

	 WARNING
	<p>No user serviceable parts inside. Refer servicing to qualified service personnel.</p> <p style="text-align: right; font-size: small;">011_051514</p>

	 CAUTION
	<p>THE FOLLOWING SECTIONS OF THIS MANUAL ARE INTENDED ONLY FOR QUALIFIED SERVICE PERSONNEL WHO ARE FAMILIAR WITH ELECTRICAL EQUIPMENT. THESE ARE NOT INTENDED FOR THE OPERATOR.</p> <p style="text-align: right; font-size: small;">027_010914</p>



ORDERING SPARE PARTS

1. Identify the needed part by checking it against the photos, illustrations, and/or parts list.
2. Use only approved replacement parts when servicing this unit.
3. When ordering, please include part number, part name, and quantity needed.
4. Please include your model number, serial number, and date of manufacture (located on the machine nameplate/data plate) with your order.
5. Address all parts orders to:

Parts Department
Gold Medal Products Co.
10700 Medallion Drive
Cincinnati, Ohio 45241-4807

Or, place orders by phone or online:

Phone: (800) 543-0862
(513) 769-7676
Fax: (800) 542-1496
(513) 769-8500
E-mail: info@gmpopcorn.com
Web Page: gmpopcorn.com



Cabinet View

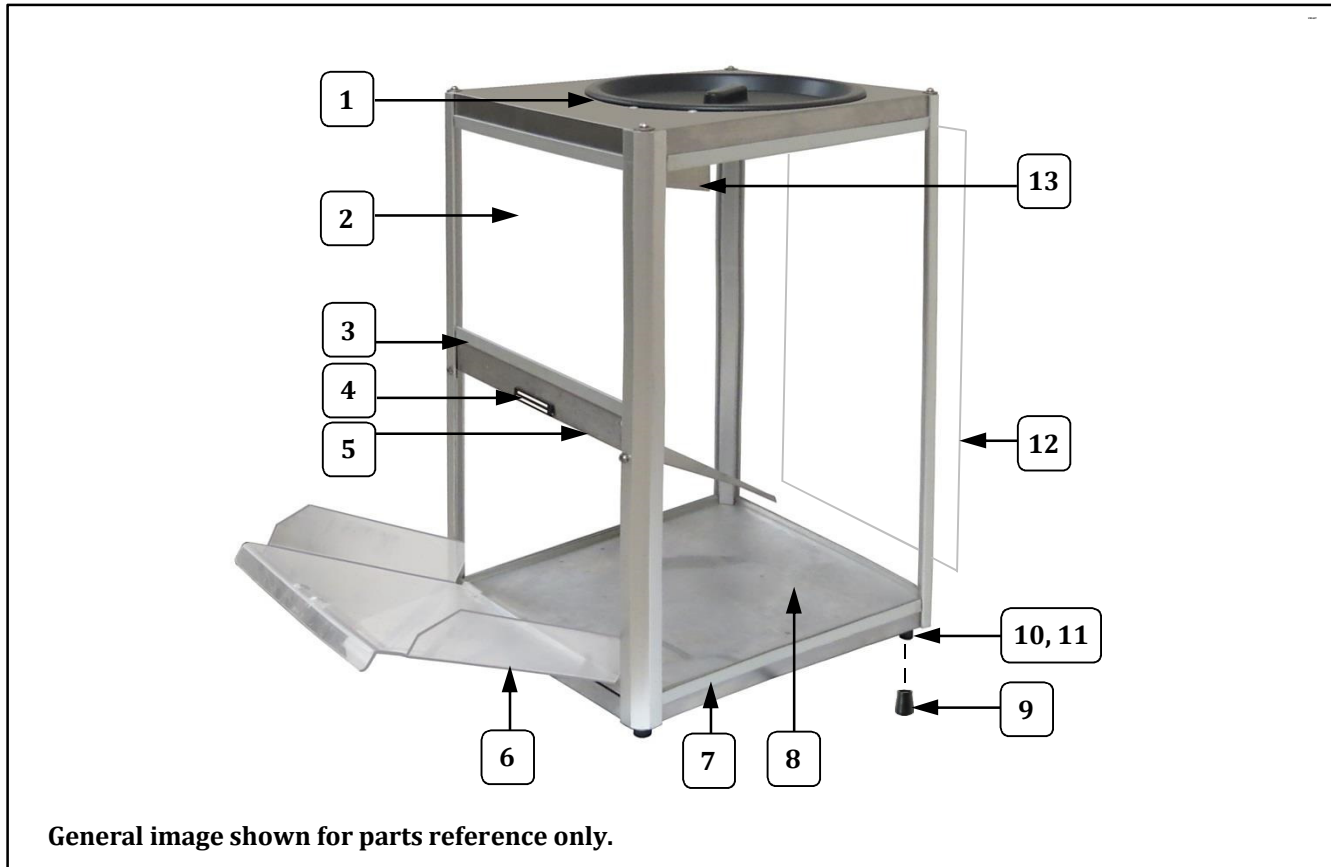

Item	Part Description	Part Number	
		2186ST	2188ST
1	LID	100288	100288
2	10 15/16" X 8 17/64" PLEXIGLAS PANEL	40016	40016
3	RETAINING EXTRUSION (10 9/32)	40021	40021
4	MAGNETIC CATCH	47561	47561
5	BAFFLE	40010	40010
6	DROP PANEL	40200	40107
7	RETAINING EXTRUSION (13 9/32)	40039	40039
8	19 13/16" X 13 15/16" PLEXIGLAS PANEL	40013	40013
9	CRUTCH TIP BLACK 70 DURO	49123	49123
10	GLIDE	47328	47328
11	SCREW, 10-24 X 3/4 HXHD	41314	41314
12	19 13/16" X 10 15/16" PLEXIGLAS PANEL	40014	40014
13	BULB PROTECTION L ANGLE	40050	40050



Cabinet - Light and Warmer View

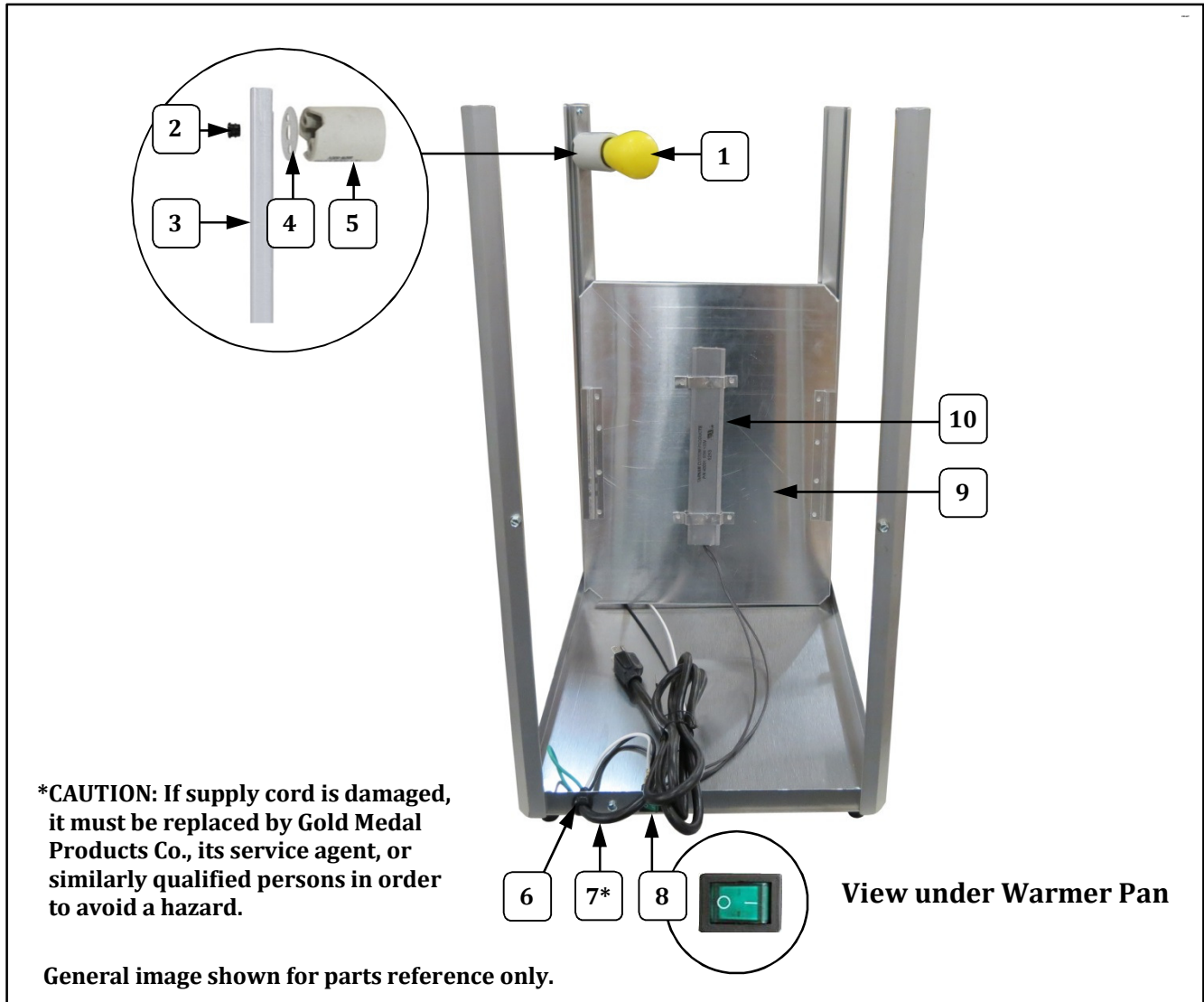

Item	Part Description	Part Number	
		2186ST	2188ST
1	YELLOW LIGHT BULB (shatterproof bulb)	11035	11035
2	.312" SNAP BUSHING	75328	75328
3	LIGHT SUPPORT CHANEL	40011	40011
4	LAMP HOLDER GASKET	40381	40381
5	LAMP HOLDER	40141	40141
6	#SR-6P3-4 STRAIN RELIEF	76026	76026
7	LEAD-IN CORD 15 AMP PLUG	22038	22038
8	DPST ROCKER SWITCH	42532	42532
9	WARMER PAN ASSEMBLY	40109	40109
10	120 VOLT 50 WATT HEAT ELEMENT	40031	
	115 VOLT 75 WATT HEAT ELEMENT		44026



Cabinet View

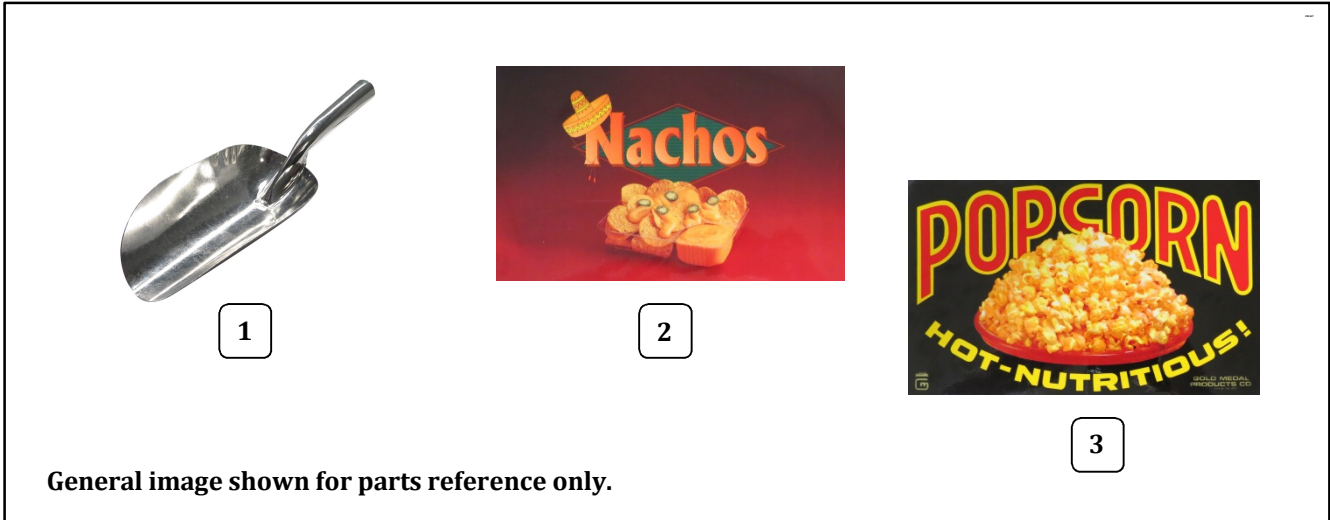

Item	Part Description	Part Number	
		2186ST	2188ST
1	STAMPED ALUMINUM SCOOP	2071	2071
2	DECAL (NACHOS)	40044	
3	POPCORN BOWL DECAL		40053



Wiring Diagram

Model No. 2186ST and 2188ST

NOTE:
ALL WIRE IS # 18 GA. LABELED APPLIANCE
WIRING WITH AT LEAST 1/32" THERMOPLASTIC
INSULATION RATED 105°C. EXCEPT AS NOTED
WIRE MUST BE U.L. LISTED AND C.S.A. CERTIFIED

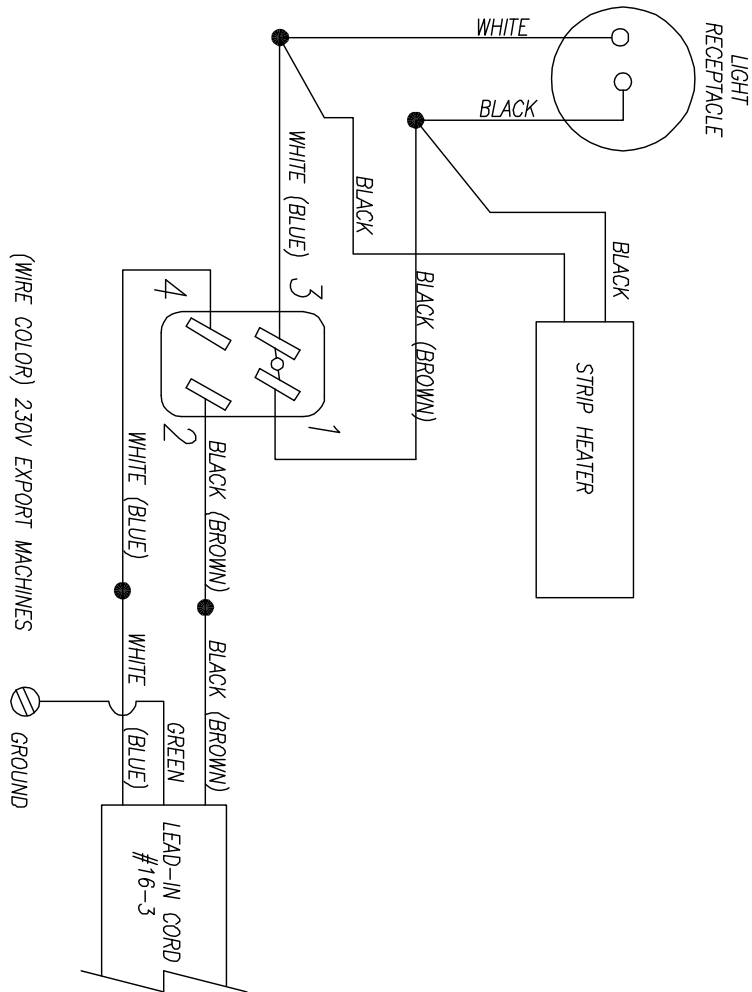



WARRANTY

Gold Medal Products Co. warrants to the original purchaser each item of its manufacture to be free of defects in workmanship and material under normal use and service. Gold Medal Products Co.'s obligation under this warranty is limited solely to repairing or replacing parts, f.o.b. Cincinnati, Ohio, which in its judgment are defective in workmanship or material and which are returned, freight prepaid, to its Cincinnati, Ohio factory or other designated point. Except for "Perishable Parts" on specific machines, the above warranty applies for a period of two (2) years from the date of original sale to the original purchaser of equipment when recommended operating instructions and maintenance procedures have been followed. These are packed with the machine. Parts warranty is two (2) years, labor is six (6) months.

THIS WARRANTY IS IN LIEU OF ALL OTHER WARRANTIES EXPRESSED OR IMPLIED, AND OF ALL OTHER OBLIGATIONS OR LIABILITIES ON OUR PART, INCLUDING THE IMPLIED WARRANTY OF MERCHANTABILITY. THERE ARE NO WARRANTIES WHICH EXTEND BEYOND THE DESCRIPTION ON THE FACE HEREOF. In no event shall Gold Medal Products Co. be liable for special, incidental or consequential damages. No claim under this warranty will be honored if the equipment covered has been misused, neglected, damaged in transit, or has been tampered with or changed in any way. No claim under this warranty shall be honored in the event that components in the unit at the time of the claim were not supplied or approved by Gold Medal Products Co. This warranty is effective only when electrical items have been properly attached to city utility lines only at proper voltages. This warranty is not transferable without the written consent of Gold Medal Products Co.

The term "Original Purchaser" as used in this warranty shall be deemed to mean that person, firm, association, or corporation who was billed by the GOLD MEDAL PRODUCTS CO., or their authorized distributor for the equipment.

THIS WARRANTY HAS NO EFFECT AND IS VOID UNLESS THE ORIGINAL PURCHASER FIRST CALLS GOLD MEDAL PRODUCTS CO. AT 1-800-543-0862 TO DISCUSS WITH OUR SERVICE REPRESENTATIVE THE EQUIPMENT PROBLEM, AND, IF NECESSARY, FOR INSTRUCTIONS CONCERNING THE REPAIR OR REPLACEMENT OF PARTS.

NOTE: This equipment is manufactured and sold for commercial use only.



GOLD MEDAL[®] PRODUCTS CO.

10700 Medallion Drive, Cincinnati, Ohio 45241-4807 USA

gmpopcorn.com

Phone: (800) 543-0862 Fax: (800) 542-1496
(513) 769-7676 (513) 769-8500