



Instruction Manual

Pre-Warmer



Model No. 2219-00-000







GOLD MEDAL[®] PRODUCTS CO.



10700 Medallion Drive, Cincinnati, Ohio 45241-4807 USA



SAFETY PRECAUTIONS

	 DANGER
	<p>Machine must be properly grounded to prevent electrical shock to personnel. Failure to do so could result in serious injury, or death. DO NOT immerse any part of this equipment in water. DO NOT use excessive water when cleaning. Keep cord and plug off the ground and away from moisture. Always unplug the equipment before cleaning or servicing. Make sure all machine switches are in the OFF position before plugging the equipment into the receptacle.</p> <p style="text-align: right; font-size: small;">008_051514</p>

	 DANGER
	<p>Improper installation, adjustment, alteration, service, or maintenance can cause property damage, injury, or death. Any alterations to this equipment will void the warranty and may cause a dangerous condition. This appliance is not intended to be operated by means of an external timer or separate remote-control system. NEVER make alterations to this equipment. Read the Installation, Operating, and Maintenance Instructions thoroughly before installing, servicing, or operating this equipment.</p> <p style="text-align: right; font-size: small;">014_020416</p>

	 WARNING
	<p>To avoid burns, DO NOT touch heated surfaces. DO NOT place or leave objects in contact with heated surfaces.</p> <p style="text-align: right; font-size: small;">009_092414</p>



	 WARNING
	<p>ALWAYS wear safety glasses when servicing this equipment.</p> <p style="text-align: right; font-size: small;">010_010914</p>

	 WARNING
	<p>No user serviceable parts inside. Refer servicing to qualified service personnel.</p> <p style="text-align: right; font-size: small;">011_051514</p>

	 WARNING
	<p>Read and understand operator's manual and all other safety instructions before using this equipment. To order copies of the operator's manual go to gmpopcorn.com or write to Gold Medal Products Co., 10700 Medallion Drive, Cincinnati, OH 45241 USA 1-(800)-543-0862</p> <p style="text-align: right; font-size: small;">022_060215</p>



SAFETY PRECAUTIONS (continued)

	 WARNING
	DO NOT allow direct contact of this equipment by the public when used in food service locations. Only personnel trained and experienced in the equipment operation may operate this equipment. Carefully read all instructions before operation. 012_010914

	 WARNING
	This machine is NOT to be operated by minors. 007_010914

Note: Improvements are always being made to Gold Medal’s equipment. This information may not be the latest available for your purposes. It is critical that you call Gold Medal’s Technical Service Department at 1-800-543-0862 for any questions about your machine operations, replacement parts, or any service questions. (Gold Medal Products Co. does not assume any liability for injury due to careless handling and/or reckless operation of this equipment.) General images may be used in manual for reference only.

INSTALLATION INSTRUCTIONS

Inspection of Shipment

After unpacking, check thoroughly for any damage which may have occurred in transit. Claims should be filed immediately with the transportation company. The warranty does not cover damage that occurs in transit, or damage caused by abuse, or consequential damage due to the operation of this machine, since it is beyond our control (reference warranty in back of manual).

Manual

Read and understand the operator's manual and all other safety instructions before using this equipment. To order copies of the operator's manual go to gmpopcorn.com or write to Gold Medal Products Co., 10700 Medallion Drive, Cincinnati, OH 45241 USA 1-(800)-543-0862.

Model Description

2219-00-000: Enclosed, bucket pre-warmer for melting solid coconut oil, or pre-warming liquid oil.

Items Included with this Unit

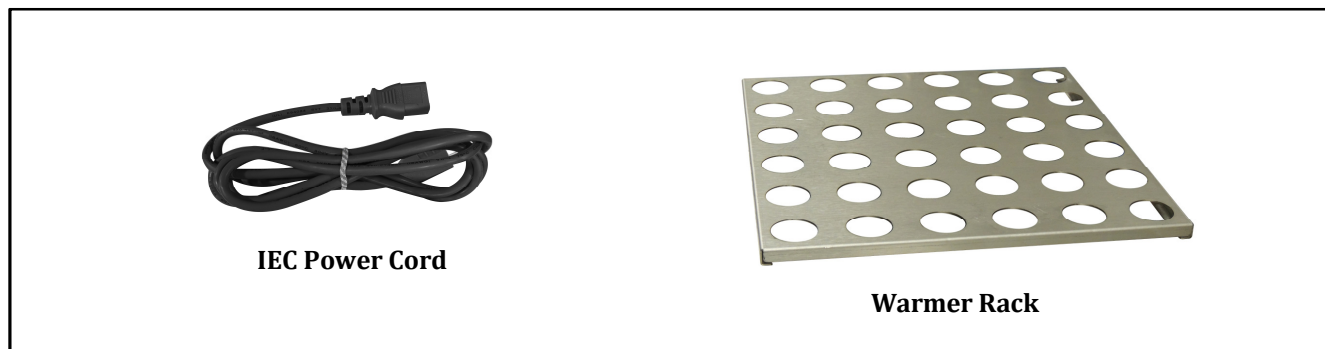

Setup



This unit has been tested at the factory.

1. Remove all packaging and tape prior to operation.
2. Place Warmer Rack in bottom of unit.
3. Place unit on a sturdy, level base for use.
4. After setup, the unit should be cleaned prior to use (see Care and Cleaning section of this manual).

Electrical Requirements

The following power supply must be provided:

2219-00-000: 120 V~, 610 W, 60 Hz

	 DANGER
	<p>Machine must be properly grounded to prevent electrical shock to personnel. Failure to do so could result in serious injury, or death. DO NOT immerse any part of this equipment in water. DO NOT use excessive water when cleaning. Keep cord and plug off the ground and away from moisture. Always unplug the equipment before cleaning or servicing. Make sure all machine switches are in the OFF position before plugging the equipment into the receptacle.</p> <p style="text-align: right;">008_051514</p>

A certified electrician must furnish sufficient power for proper machine operation and install any supplied receptacle. We recommend this equipment be on a dedicated and protected circuit. Failure to wire properly will void the warranty and may result in damage to the machine. It is Gold Medal Products Co.'s recommendation that this machine be plugged directly into a wall outlet. The use of extension cords is not recommended due to safety concerns, and may cause sacrificed and/or reduced performance. Make sure cord is located to prevent a trip hazard or unit upset.

Before You Plug In Machine

1. Make sure all machine switches are in the OFF position before plugging the equipment into the receptacle.
2. Make sure the wall outlet can accept the grounded plugs (where applicable) on the power supply cord.
3. The wall outlet must have the proper polarity. If in doubt, have a competent electrician inspect the outlet and correct if necessary.
4. **DO NOT** use a grounded to un-grounded receptacle adapter (where applicable).
5. Install the unit in a level position.

	 CAUTION
	<p>If the supply cord is damaged, it must be replaced by a special cord or assembly available from Gold Medal Products Co. or its service agent.</p> <p style="text-align: right;">038_062714</p>



OPERATING INSTRUCTIONS

Controls and Their Functions

POWER SWITCH

Three position rocker switch (HI, LO, OFF) – provides power to the heating element and blower.

INDICATOR LIGHT

The green light is ON, indicates there is power to the unit.

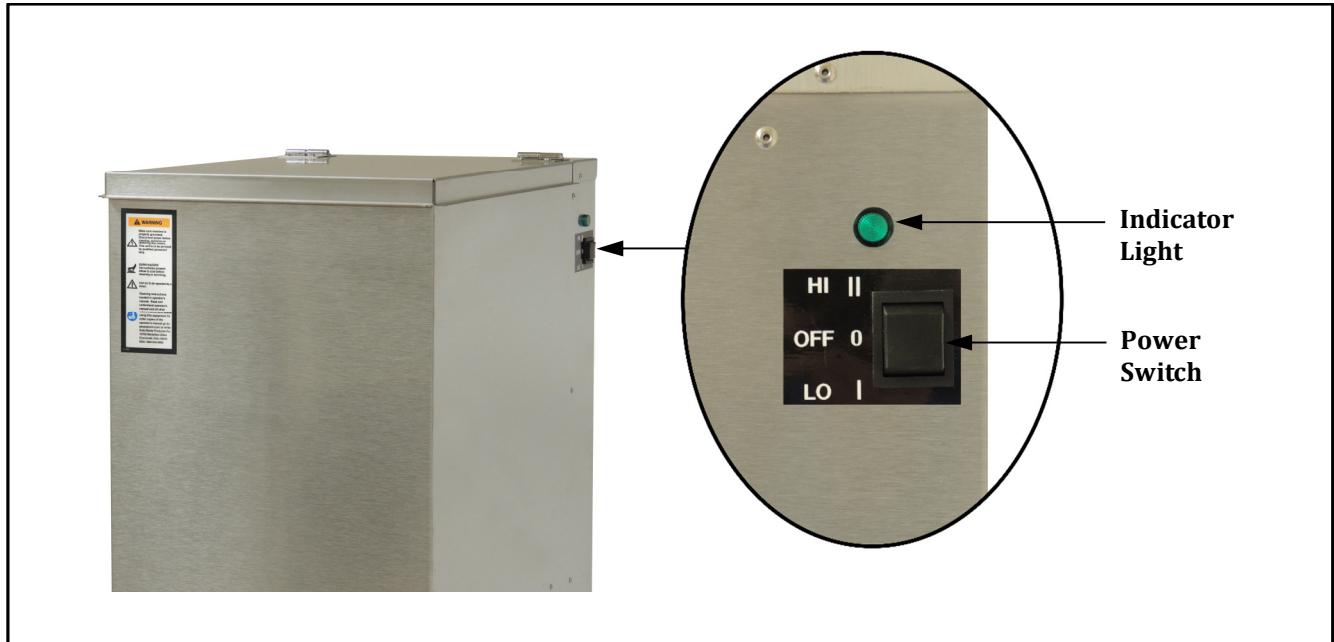

Operating Instructions

Follow the instructions below for operating the pre-warmer:

1. Open lid, ensure the warmer rack is in place in the bottom of the unit (rack allows air to circulate).
2. Place a 5 gallon bucket (with lid) of solid coconut oil in unit; close the warmer's lid.
3. Set Power Switch to HI. (A bucket of solid coconut oil will take approximately 8 hours to melt.)

Note: To pre-warm liquid oil, set the unit to HI. Once oil is warmed, the unit may be switched to the LO setting to maintain till use.

4. Turn unit OFF when not in use.



Care and Cleaning

	⚠ DANGER
	Machine must be properly grounded to prevent electrical shock to personnel. DO NOT immerse in water. DO NOT clean appliance with a water jet. Always unplug the equipment before cleaning or servicing. 025_111616

	⚠ WARNING
	To avoid burns, DO NOT touch heated surfaces. DO NOT place or leave objects in contact with heated surfaces. 009_092414

Good sanitation practice demands that all food preparation equipment be cleaned regularly (only use non-toxic, food grade cleaners). A clean looking, well-kept machine is one of the best ways of advertising your product.

Follow the directions below to clean and sanitize the unit each day after use.

1. With the machine OFF, unplug the unit and allow it to cool before attempting to clean.
2. Make sure to clean all of the pans (racks) in order to sanitize them before each use.
3. Clean the outside of the unit with a soft cloth, dampened with soap and hot water.
4. Wipe the stainless steel parts with a clean cloth and cleaner designed for stainless steel, such as Gold Medal Watchdog Stainless Cleaner (Item No. 2088).

DO NOT use oven cleaners or abrasive materials as they will damage parts of the machine.



Troubleshooting

Issue	Possible Cause	Solution
Unit does not Heat	A. Power to Unit B. Thermostat or Element	A. Ensure the IEC power cord is securely plugged into the back of the unit, and make sure the power cord is plugged into the wall receptacle. B. If the indicator light is ON, but the unit does not heat, a thermostat or element may be defective. Check with a qualified service person for inspection/repair.
Unit Heats Slow	A. Switch Setting B. Rack C. Fan	A. Ensure the unit is on the HI setting. It takes approximately 8 hours on the HI setting to melt a 5 gallon bucket of solid coconut oil. B. Poor air circulation may cause the unit to heat slowly. Ensure the warmer rack provided is placed under the bucket of oil inside the unit. C. If the fan is not operating, the air will not circulate properly. Check with a qualified service person for inspection/repair.



MAINTENANCE INSTRUCTIONS

	⚠ DANGER
	<p>Machine must be properly grounded to prevent electrical shock to personnel. Failure to do so could result in serious injury, or death. DO NOT immerse any part of this equipment in water. DO NOT use excessive water when cleaning. Keep cord and plug off the ground and away from moisture. Always unplug the equipment before cleaning or servicing. Make sure all machine switches are in the OFF position before plugging the equipment into the receptacle.</p> <p>008_051514</p>

	⚠ DANGER
	<p>Improper installation, adjustment, alteration, service, or maintenance can cause property damage, injury, or death. Any alterations to this equipment will void the warranty and may cause a dangerous condition. This appliance is not intended to be operated by means of an external timer or separate remote-control system. NEVER make alterations to this equipment. Read the Installation, Operating, and Maintenance Instructions thoroughly before installing, servicing, or operating this equipment.</p> <p>014_020416</p>

	⚠ WARNING
	<p>No user serviceable parts inside. Refer servicing to qualified service personnel.</p> <p>011_051514</p>

	⚠ CAUTION
	<p>THE FOLLOWING SECTIONS OF THIS MANUAL ARE INTENDED ONLY FOR QUALIFIED SERVICE PERSONNEL WHO ARE FAMILIAR WITH ELECTRICAL EQUIPMENT. THESE ARE NOT INTENDED FOR THE OPERATOR.</p> <p>027_010914</p>



ORDERING SPARE PARTS

1. Identify the needed part by checking it against the photos, illustrations, and/or parts list. (General images may be used in manual for reference only.)
2. Use only approved replacement parts when servicing this unit.
3. When ordering, please include part number, part name, and quantity needed.
4. Please include your model number, serial number, and date of manufacture (located on the machine nameplate/data plate) with your order.
5. Address all parts orders to:

Parts Department
Gold Medal Products Co.
10700 Medallion Drive
Cincinnati, Ohio 45241-4807

Or, place orders by phone or online:

Phone: (800) 543-0862
(513) 769-7676
Fax: (800) 542-1496
(513) 769-8500
E-mail: info@gmpopcorn.com
Web Page: gmpopcorn.com



Cabinet Exterior – Parts Breakdown

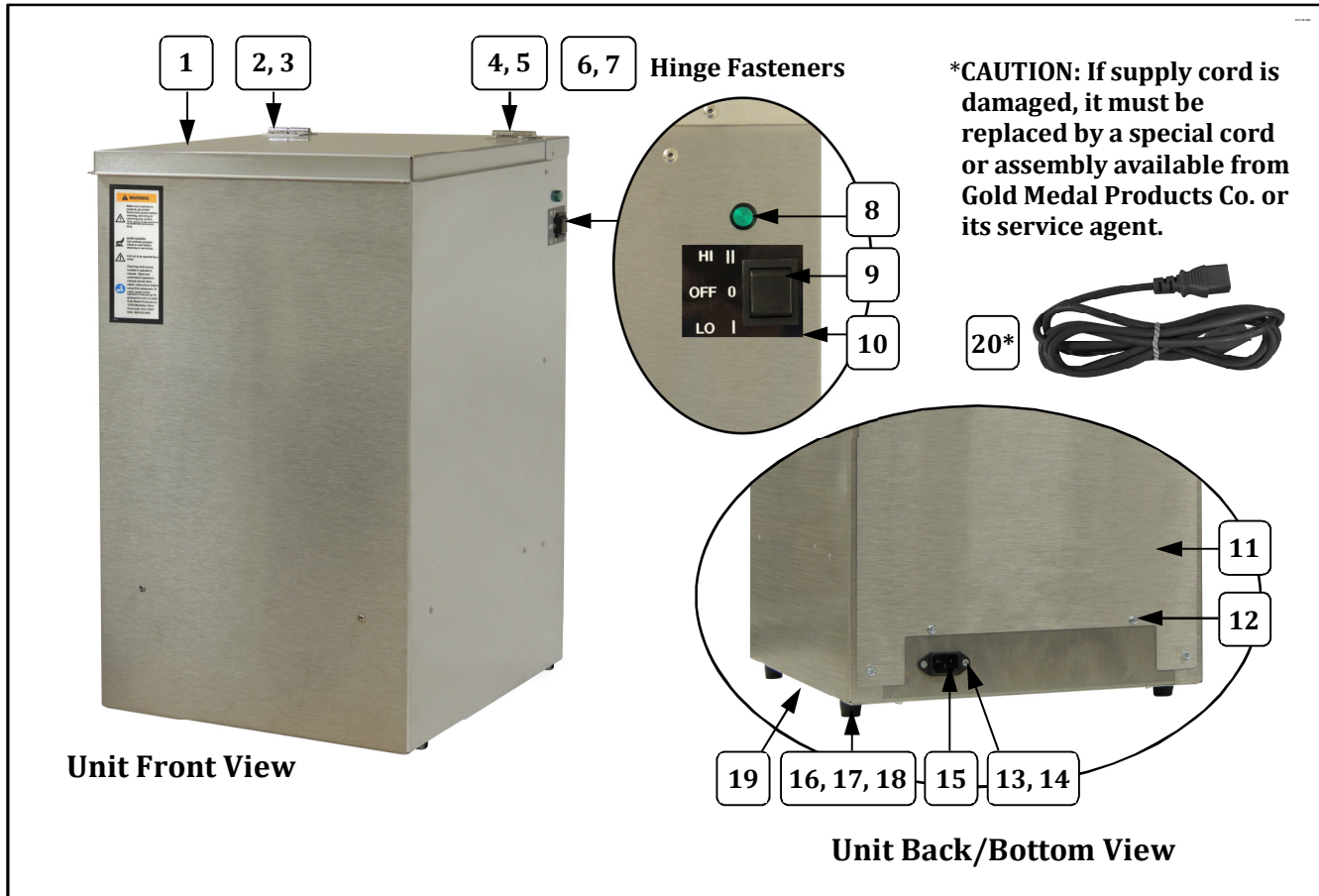

Item	Part Description	Part Number
		2219-00-000
1	WARMER LID	111413
2	MALE HINGE SHORT RIGHT	41350
3	FEMALE HINGE RIGHT	41354
4	MALE HINGE SHORT LEFT	41349
5	FEMALE HINGE LEFT	41355
6	8-32 X 3/8 PAN HD PH M/	12389
7	8-32 HEX NUT, ESLOK, S.S.	22070
8	PILOT LIGHT-125V GREEN	41469
9	3 POSITION ROCKER SWITCH	39410
10	LABEL, SELECTOR SWITCH	111410
11	WARMER REAR COVER	111381
12	SCREW #8-32X3/8 PAN HD PH	74141
13	6-32 X 1/2 PH FLAT HD M/S	41796
14	6-32 GRIP NUT ZINC PLATED	47517
15	IEC CONNECTOR,FLANGED	102013
16	RUBBER FOOT 3/4IN HIGH (4 required)	47155
17	8-32 X 1 PH PAN M/S S.S	12219
18	8-32 SERRATED FLANGE NUT	61151
19	WARMER BOTTOM COVER	111380
20*	POWER CORD,16 AWG,	102020



Cabinet Interior

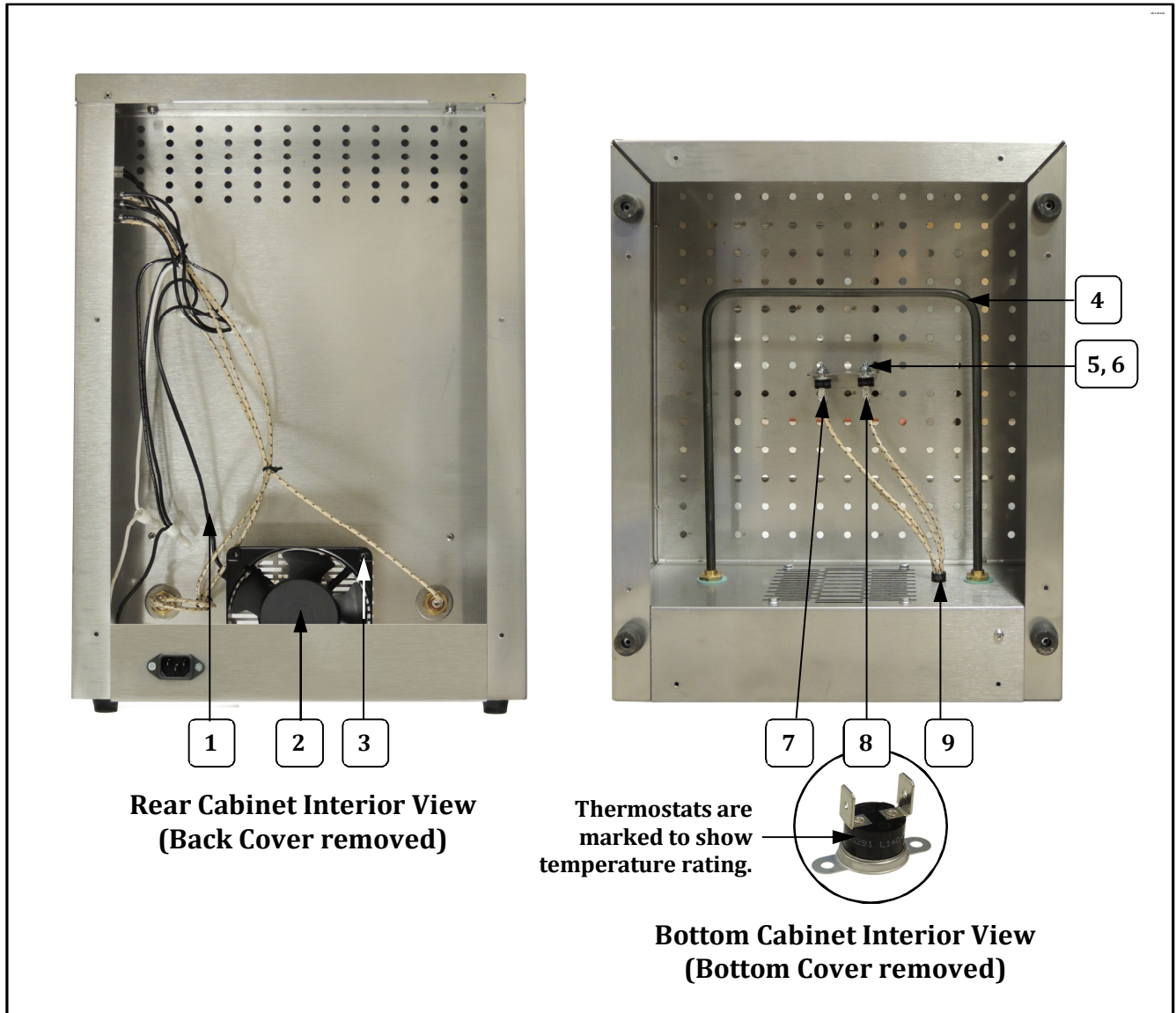

Item	Part Description	Part Number
		2219-00-000
1	EXHST BLOWER PLUG & CORD	47199
2	EXHAUST BLOWER 120V,60CY	48018
3	8-32 X 3/4 UNSL NON-IND	39008
4	600 WATT HEAT ELEMENT	43287
5	6-32 X 3/8 PH PAN HD M/S	38087
6	6-32 GRIP NUT ZINC PLATED	47517
7	THERMOSTAT 120 DISC 3/16	36111
8	THERMOSTAT 140 DEF F	36078
9	BUSHING, SNAP .500 IN	47236



Safety Labels

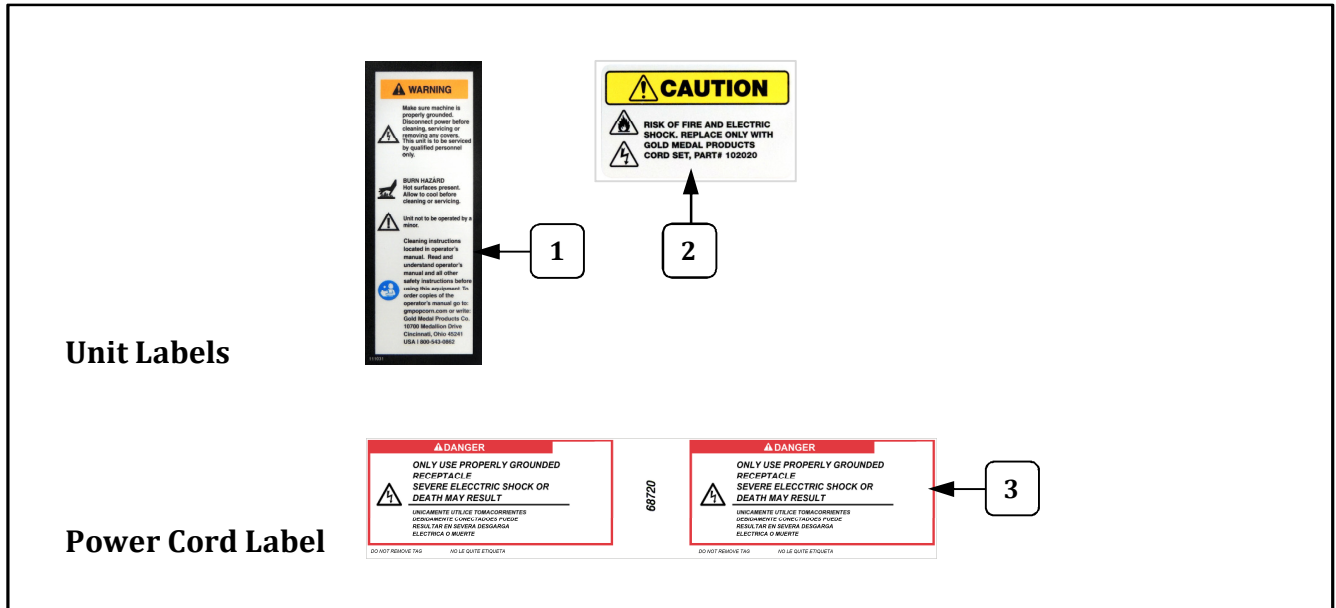

Item	Part Description	Part Number
		2219-00-000
1	COOKER LABEL	111031
2	CAUTION CORD SET LABEL	102032
3	WARNING LABEL CORD	68720

Accessories

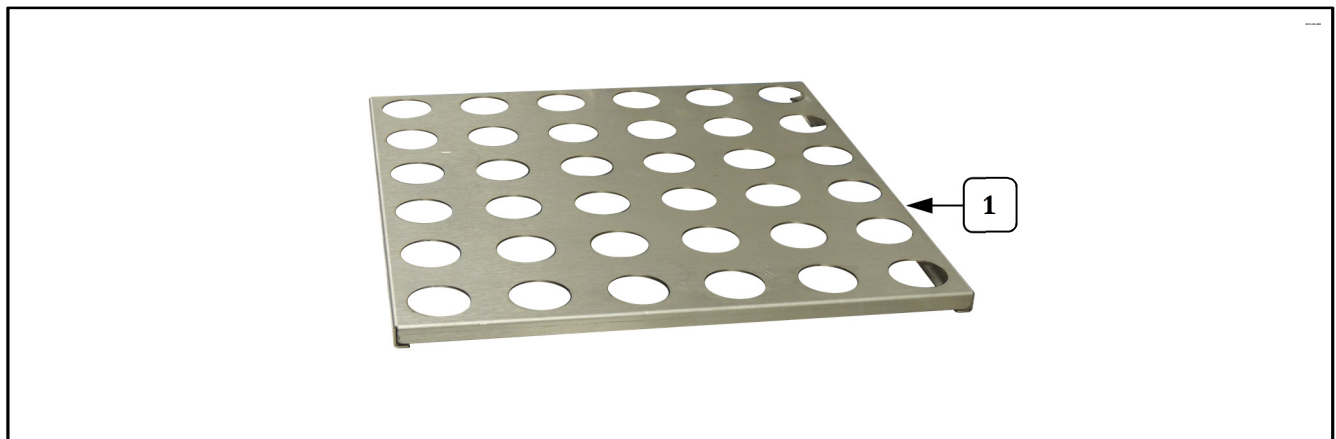

Item	Part Description	Part Number
		2219-00-000
1	Warmer rack	111414



Wiring Diagram

Model No. 2219-00-000

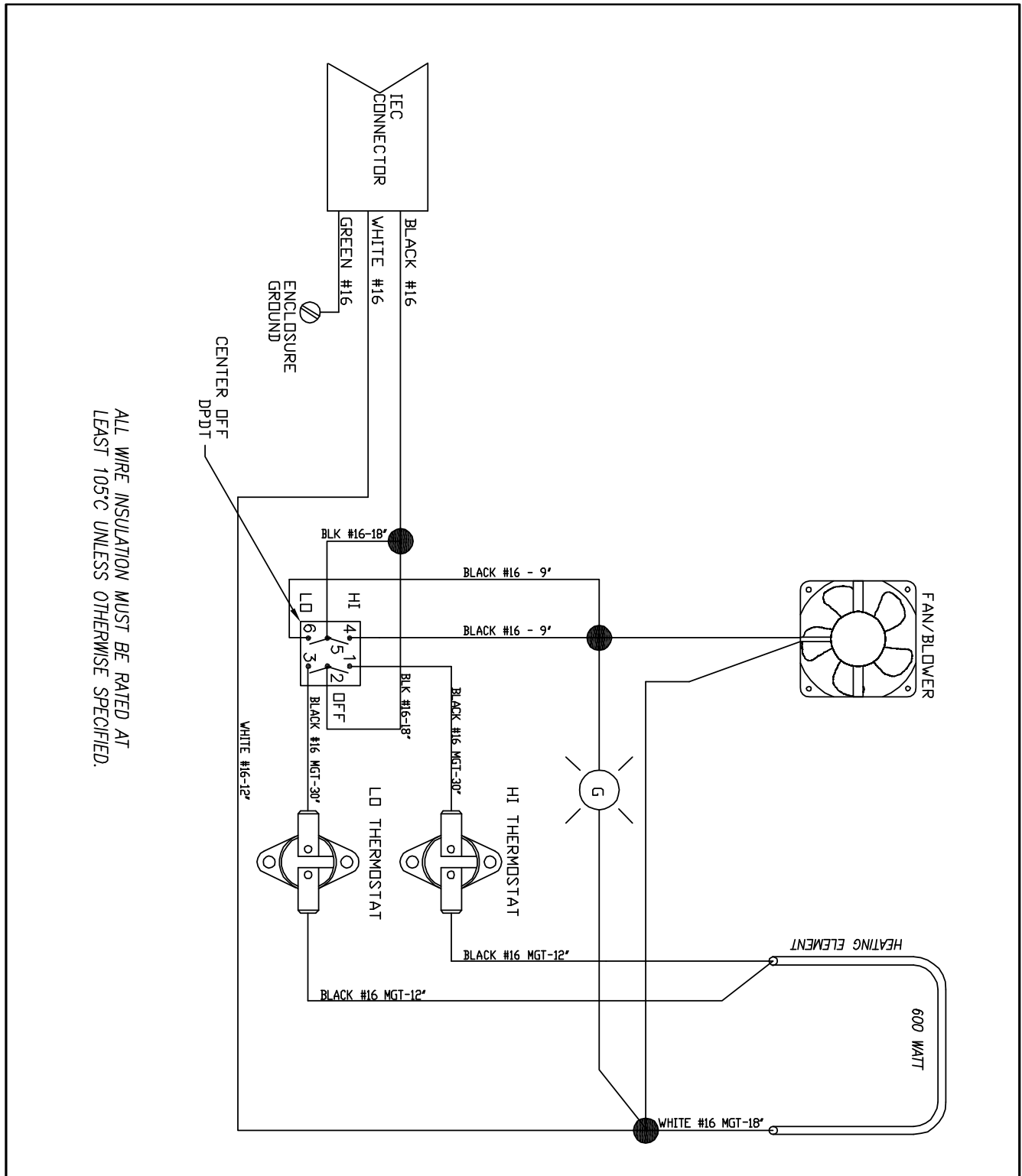



WARRANTY

Gold Medal Products Co. warrants to the original purchaser each item of its manufacture to be free of defects in workmanship and material under normal use and service. Gold Medal Products Co.'s obligation under this warranty is limited solely to repairing or replacing parts, f.o.b. Cincinnati, Ohio, which in its judgment are defective in workmanship or material and which are returned, freight prepaid, to its Cincinnati, Ohio factory or other designated point. Except for "Perishable Parts" on specific machines, the above warranty applies for a period of two (2) years from the date of original sale to the original purchaser of equipment when recommended operating instructions and maintenance procedures have been followed. These are packed with the machine. Parts warranty is two (2) years, labor is six (6) months.

THIS WARRANTY IS IN LIEU OF ALL OTHER WARRANTIES EXPRESSED OR IMPLIED, AND OF ALL OTHER OBLIGATIONS OR LIABILITIES ON OUR PART, INCLUDING THE IMPLIED WARRANTY OF MERCHANTABILITY. THERE ARE NO WARRANTIES WHICH EXTEND BEYOND THE DESCRIPTION ON THE FACE HEREOF. In no event shall Gold Medal Products Co. be liable for special, incidental or consequential damages. No claim under this warranty will be honored if the equipment covered has been misused, neglected, damaged in transit, or has been tampered with or changed in any way. No claim under this warranty shall be honored in the event that components in the unit at the time of the claim were not supplied or approved by Gold Medal Products Co. This warranty is effective only when electrical items have been properly attached to city utility lines only at proper voltages. This warranty is not transferable without the written consent of Gold Medal Products Co.

The term "Original Purchaser" as used in this warranty shall be deemed to mean that person, firm, association, or corporation who was billed by the GOLD MEDAL PRODUCTS CO., or their authorized distributor for the equipment.

THIS WARRANTY HAS NO EFFECT AND IS VOID UNLESS THE ORIGINAL PURCHASER FIRST CALLS GOLD MEDAL PRODUCTS CO. AT 1-800-543-0862 TO DISCUSS WITH OUR SERVICE REPRESENTATIVE THE EQUIPMENT PROBLEM, AND, IF NECESSARY, FOR INSTRUCTIONS CONCERNING THE REPAIR OR REPLACEMENT OF PARTS.

NOTE: This equipment is manufactured and sold for commercial use only.



GOLD MEDAL[®] PRODUCTS CO.

10700 Medallion Drive, Cincinnati, Ohio 45241-4807 USA

gmpopcorn.com

Phone: (800) 543-0862 Fax: (800) 542-1496
(513) 769-7676 (513) 769-8500