



# Instruction Manual

## Cheddar Easy All-In-One Cheese Corn Shop

Model No. 2703-00-000







**GOLD MEDAL® PRODUCTS CO.**



10700 Medallion Drive, Cincinnati, Ohio 45241-4807 USA







# SAFETY PRECAUTIONS

	 <b>DANGER</b>
	<p>Machine must be properly grounded to prevent electrical shock to personnel. Failure to do so could result in serious injury, or death. Make sure all machine switches are in the OFF position before plugging the equipment into the receptacle. Keep cord and plug off the ground and away from moisture. Always unplug the equipment before cleaning or servicing. DO NOT immerse any part of this equipment in water. DO NOT use a water jet or excessive water when cleaning.</p> <p>008_012221</p>

	 <b>DANGER</b>
	<p>Improper installation, adjustment, alteration, service, or maintenance can cause property damage, injury, or death. Any alterations to this equipment will void the warranty and may cause a dangerous condition. This appliance is not intended to be operated by means of an external timer or separate remote-control system. NEVER make alterations to this equipment. Read the Installation, Operating, and Maintenance Instructions thoroughly before installing, servicing, or operating this equipment.</p> <p>014_020416</p>



	 <b>WARNING</b>
	<p>To avoid burns, DO NOT touch heated surfaces. DO NOT place or leave objects in contact with heated surfaces.</p> <p>009_092414</p>

	 <b>WARNING</b>
	<p>ALWAYS wear safety glasses when servicing this equipment.</p> <p>010_010914</p>

	 <b>WARNING</b>
	<p>No user serviceable parts inside. Refer servicing to qualified service personnel.</p> <p>011_051514</p>

	 <b>WARNING</b>
	<p>Read and understand operator's manual and all other safety instructions before using this equipment. To order copies of the operator's manual go to <a href="http://gmpopcorn.com">gmpopcorn.com</a> or write to Gold Medal Products Co., 10700 Medallion Drive, Cincinnati, OH 45241 USA 1-(800)-543-0862</p> <p>022_060215</p>



	 <b>WARNING</b>
	DO NOT allow direct contact of this equipment by the public when used in food service locations. Only personnel trained and experienced in the equipment operation may operate this equipment. Carefully read all instructions before operation. <span style="float: right;">012_010914</span>

	 <b>WARNING</b>
	This machine is NOT to be operated by minors. <span style="float: right;">007_010914</span>

	 <b>CAUTION</b>
	If the supply cord is damaged, it must be replaced by Gold Medal Products Co., its service agent or similarly qualified persons in order to avoid a hazard. <span style="float: right;">039_080614</span>

**Note:** Improvements are always being made to Gold Medal's equipment. This information may not be the latest available for your purposes. It is critical that you call Gold Medal's Technical Service Department at 1-800-543-0862 for any questions about your machine operations, replacement parts, or any service questions. (Gold Medal Products Co. does not assume any liability for injury due to careless handling and/or reckless operation of this equipment.) General images may be used in manual for reference only.

# INSTALLATION INSTRUCTIONS

## Inspection of Shipment

After unpacking, check thoroughly for any damage which may have occurred in transit. Claims should be filed immediately with the transportation company. The warranty does not cover damage that occurs in transit, or damage caused by abuse, or consequential damage due to the operation of this machine, since it is beyond our control (reference warranty in back of manual).

## Manual

Read and understand the operator's manual and all other safety instructions before using this equipment. To order copies of the operator's manual go to [gmpopcorn.com](http://gmpopcorn.com) or write to Gold Medal Products Co., 10700 Medallion Drive, Cincinnati, OH 45241 USA 1-(800)-543-0862.

## Model Description

**2703-00-000:** Cheddar Easy All-In-One Cheese Corn Shop, 8 gallon capacity.

## Items Included with this Unit



**4 Cup Glass Beaker  
(Cheese Measure)**  
(PN 111355)



**Blade Scraper**  
(PN 111244)



**Heat Lamp Bulb**  
(PN 47139)

## Setup

1. Remove all packaging and tape prior to operation.
2. Place unit on a sturdy, level base for use.
3. With the machine OFF and unplugged, install the heat lamp (reference image shown).
4. Place Blending Pot on rollers for use.
5. After setup, the unit should be cleaned prior to use (see Care and Cleaning section).

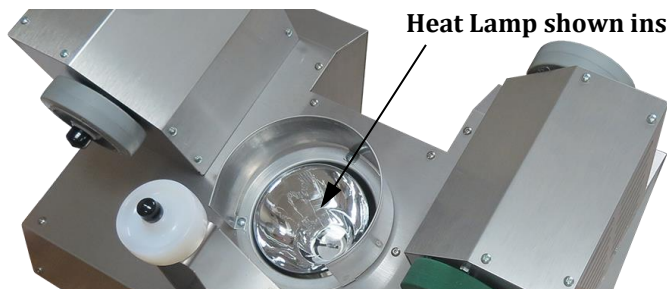

Heat Lamp shown installed in unit.



Rear View



## Electrical Requirements

The following power supply must be provided (reference unit Data Plate for Wattage requirement):

120 V~, 60 Hz

	 <b>DANGER</b>
	<p>Machine must be properly grounded to prevent electrical shock to personnel. Failure to do so could result in serious injury, or death. Make sure all machine switches are in the OFF position before plugging the equipment into the receptacle. Keep cord and plug off the ground and away from moisture. Always unplug the equipment before cleaning or servicing. DO NOT immerse any part of this equipment in water. DO NOT use a water jet or excessive water when cleaning.</p> <p style="text-align: right;">008_012221</p>

A certified electrician must furnish sufficient power for proper machine operation and install any supplied receptacle (reference unit Data Plate for model specific Volts AC, Hertz, and Wattage requirements). We recommend this equipment be on a dedicated and protected circuit. Failure to wire properly will void the warranty and may result in damage to the machine. It is Gold Medal Products Co.'s recommendation that this machine be plugged directly into a wall outlet. The use of extension cords is not recommended due to safety concerns, and may cause sacrificed and/or reduced performance. Make sure cord is located to prevent a trip hazard or unit upset.

## Before You Plug In Machine

1. Make sure all machine switches are OFF before plugging equipment into receptacle.
2. Make sure wall outlet can accept the grounded plugs (where applicable) on the power supply cord.
3. The wall outlet must have the proper polarity. If in doubt, have a competent electrician inspect the outlet and correct if necessary.
4. **DO NOT** use a grounded to un-grounded receptacle adapter (where applicable).
5. Install unit in a level position.

	 <b>CAUTION</b>
	<p>If the supply cord is damaged, it must be replaced by Gold Medal Products Co., its service agent or similarly qualified persons in order to avoid a hazard.</p> <p style="text-align: right;">039_080614</p>

# OPERATING INSTRUCTIONS

## Controls and Their Functions

### TUMBLER SWITCH

Two position, ON/OFF lighted rocker switch - supplies power to the tumbler drive motor. With this switch in the ON position, the blending pot will continually roll.

### TUMBLER HEAT SWITCH

Two position, ON/OFF lighted rocker switch - turns the Heat Lamp ON/OFF.

### WARMING PLATE HEAT CONTROL

Graduated dial from LO to HIGH which controls the warming plate heat.

### INDICATOR LIGHT

When lit, this light indicates the warming plate is ON.

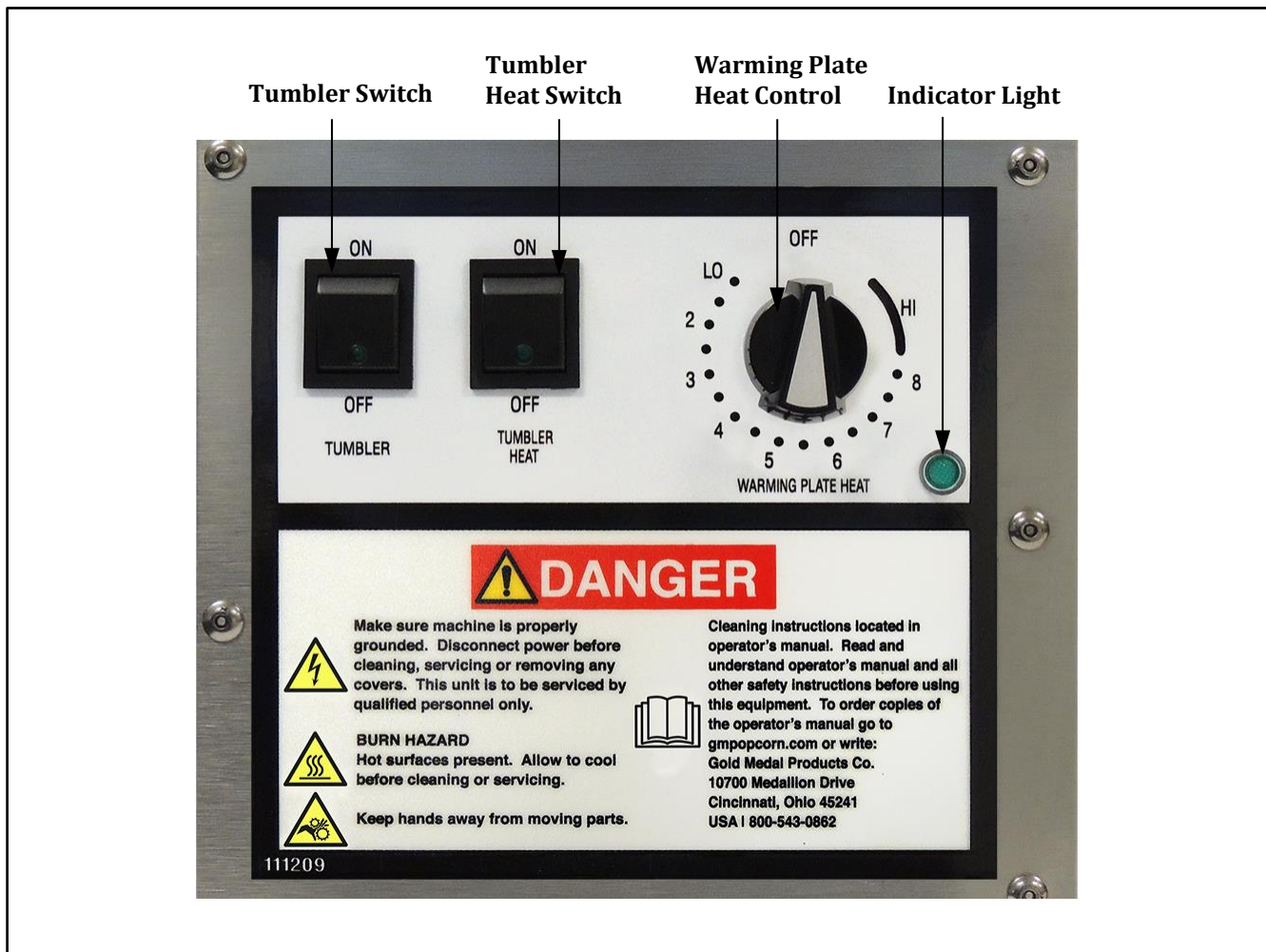



---

## Operating Instructions

1. Place the Blending Pot on all the rollers securely (the Blending Pot has an 8 gallon capacity).
2. Fill the Cheese Measure with 3 cups of Gold Medal Products Co. Cheddar Pure Gold (Item No. 2327) and place on the warming plate.
3. Set the Warming Plate Heat Control on HIGH for approximately 20 minutes to warm the cheese. Stir occasionally for even heating, then reduce the temperature to prevent overheating.

**CAUTION:** Cheese Measure will be hot; DO NOT touch it with your hands. Use oven mitt or similar protective device when handling Cheese Measure.

**The warming plate should be turned OFF when not in use.**

4. Add product to be mixed to the Blending Pot.
5. Turn the Tumbler Switch ON and begin tumbling the product.
6. Turn the Tumbler Heat Switch ON to keep the product warm while tumbling.
7. For cheese corn, begin adding cheese mixture until the corn is coated as desired.
8. Turn the Tumbler Switch OFF.
9. Remove the Blending Pot and empty the contents.
10. Repeat the process for additional product.

## Care and Cleaning

	<b>⚠ DANGER</b>
	Machine must be properly grounded to prevent electrical shock to personnel. <b>DO NOT immerse in water.</b> DO NOT clean appliance with a water jet or steam cleaner. Always unplug the equipment before cleaning or servicing. 025_051321

	<b>⚠ WARNING</b>
	To avoid burns, DO NOT touch heated surfaces. DO NOT place or leave objects in contact with heated surfaces. 009_092414

Good sanitation practice demands that all food preparation equipment be cleaned regularly (only use non-toxic, food grade cleaners).

For surfaces needing further cleaning or degreasing, Watchdog Stainless Cleaner (Item No. 2088) or Watchdog Concession Equipment Degreaser (Item No. 2580) is available for use accordingly. For any cleaning products used, follow the manufacturer's instructions on the product. **DO NOT use oven cleaners or abrasive materials** as they will damage parts of machine.



Follow the directions below to clean the unit each day after use.



1. Turn machine OFF, unplug unit and allow it to cool before attempting to clean.
2. Remove all pans/accessories and take them to the sink to clean with soap and water, then rinse and dry.
3. Clean unit with a soft cloth, slightly dampened with soap and hot water, then wipe again to remove any remaining cleaner.





—THE FOLLOWING SECTIONS ARE FOR QUALIFIED SERVICE PERSONNEL ONLY—

## MAINTENANCE INSTRUCTIONS

	 <b>DANGER</b>
	<p>Machine must be properly grounded to prevent electrical shock to personnel. Failure to do so could result in serious injury, or death. Make sure all machine switches are in the OFF position before plugging the equipment into the receptacle. Keep cord and plug off the ground and away from moisture. Always unplug the equipment before cleaning or servicing. DO NOT immerse any part of this equipment in water. DO NOT use a water jet or excessive water when cleaning.</p> <p>008_012221</p>

	 <b>DANGER</b>
	<p>Improper installation, adjustment, alteration, service, or maintenance can cause property damage, injury, or death. Any alterations to this equipment will void the warranty and may cause a dangerous condition. This appliance is not intended to be operated by means of an external timer or separate remote-control system. NEVER make alterations to this equipment. Read the Installation, Operating, and Maintenance Instructions thoroughly before installing, servicing, or operating this equipment.</p> <p>014_020416</p>

	 <b>WARNING</b>
	<p>No user serviceable parts inside. Refer servicing to qualified service personnel.</p> <p>011_051514</p>

	 <b>CAUTION</b>
	<p>THE FOLLOWING SECTIONS OF THIS MANUAL ARE INTENDED ONLY FOR QUALIFIED SERVICE PERSONNEL WHO ARE FAMILIAR WITH ELECTRICAL EQUIPMENT. THESE ARE NOT INTENDED FOR THE OPERATOR.</p> <p>027_010914</p>



---

## **ORDERING SPARE PARTS**

1. Identify the needed part by checking it against the photos, illustrations, and/or parts list. (General images may be used in manual for reference only.)
2. Use only approved replacement parts when servicing this unit.
3. When ordering, please include part number, part name, and quantity needed.
4. Please include your model number, serial number, and date of manufacture (located on the machine nameplate/data plate) with your order.
5. Address all parts orders to Parts Department, Gold Medal Products Co., 10700 Medallion Drive, Cincinnati, Ohio 45241-4807

or place orders by phone or online:

Phone: (800) 543-0862  
(513) 769-7676

Fax: (800) 542-1496  
(513) 769-8500

E-mail: [info@gmpopcorn.com](mailto:info@gmpopcorn.com)  
Web Page: [gmpopcorn.com](http://gmpopcorn.com)

## Cabinet Exterior Front and Controls View

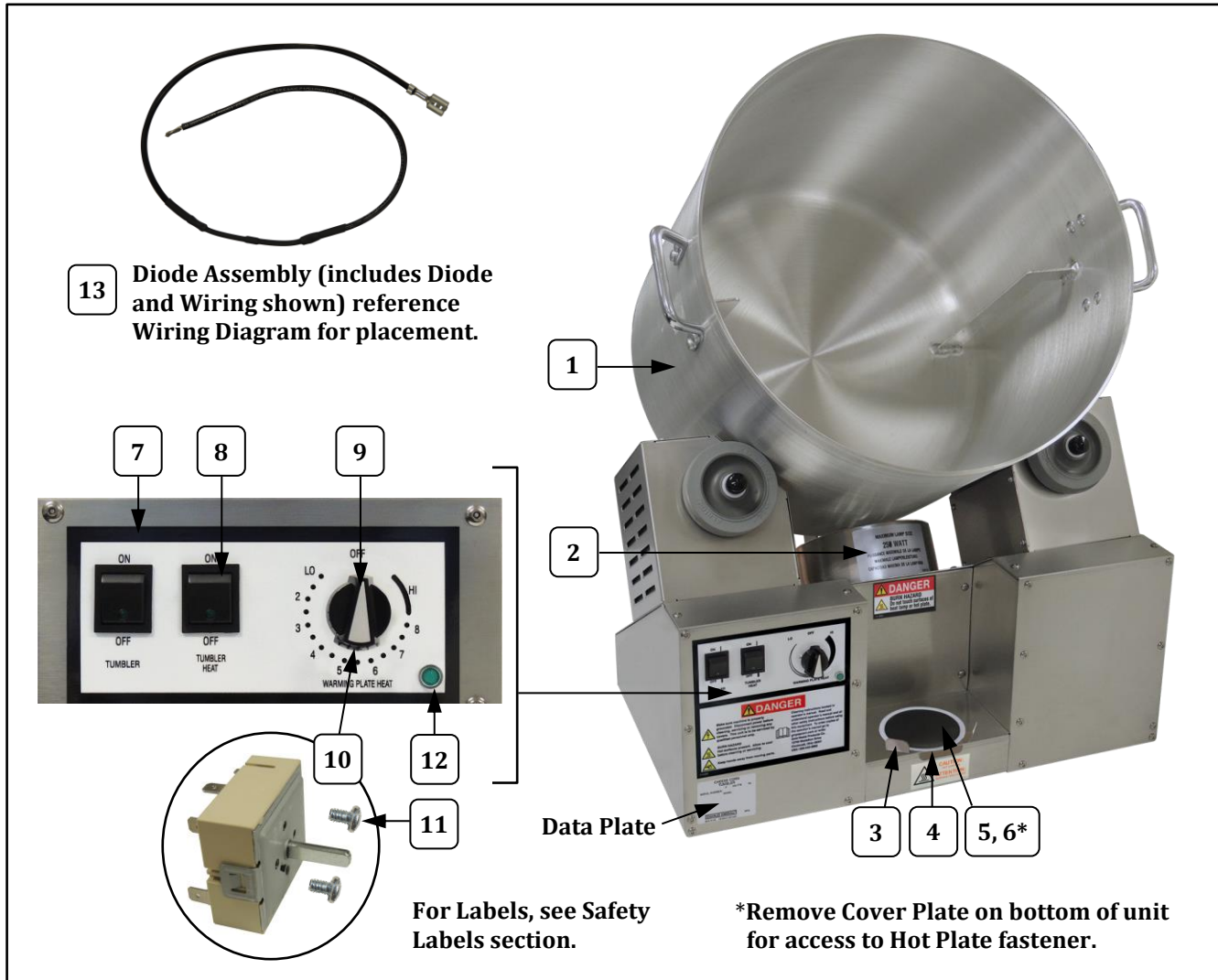

Item	Part Description	Part Number
		2703-00-000
1	BLENDING POT WELDMENT	17491
2	LIGHT SHIELD	111276
3	CUP SUPPORT	114049
4	TEFLON RING	111281
5	HOT PLATE 450W	111205
6*	M4 HEX NUT (fastener for hot plate)	111207
7	TUMBLER LABEL	111209
8	SWITCH, LIGHTED ROCKER GR	42798
9	CONTROL KNOB	38389
10	HEAT CONTROL	87297
11	8-32 X 1/4 PHIL PAN M/S	87314
12	PILOT LIGHT, GREEN	48660
13	DIODE ASSEMBLY	111283

## Cabinet Rear and Bottom View – Parts Breakdown

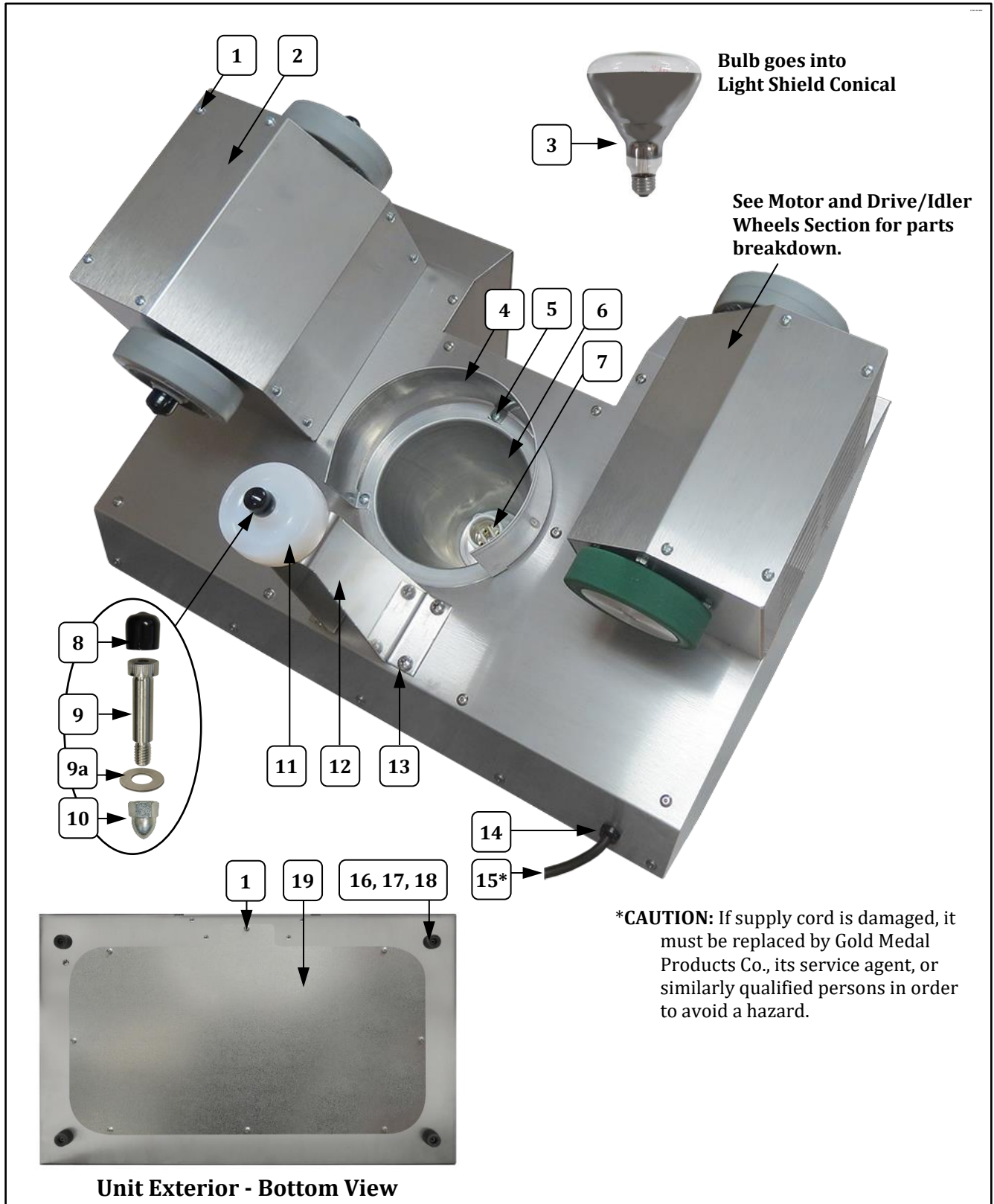



## Cabinet Rear and Bottom View – Parts List

Item	Part Description	Part Number
		2703-00-000
1	SCREW #8-32X3/8 PAN HD PH	74141
2	COVER PLATE	111203
3	HEAT LAMP 250W, 115/125V	47139
4	LIGHT SHIELD	111276
5	10-24 X 3/8 PAN HD PH T23	38111
6	LIGHT SHIELD, CONICAL	53077
7	LAMP HOLDER	47047
8	CAP	17784
9	3/8 X 1-1/2 SHOULDER BOLT	111208
9a	3/8IN FLAT WASHER, ZINC	111231
10	ACORN NUT 5/16-18	77610
11	NYLON WHEEL	17504
12	IDLER BRACKET	111240
13	1/4-20 X 1/2 P/H PHIL	12471
14	STRAIN RELIEF#SR-6N-4	87810
15*	15 AMP PLUG LEAD – IN CORD	22038
16	RUBBER FEET 3/4IN HIGH	47155
17	8-32 X 1 PH PAN M/S S.S.	12219
18	8-32 SERRATED FLANGE NUT	61151
19	COVER (bottom cover for access to controls interior)	111479

## Motor and Drive/Idler Wheels

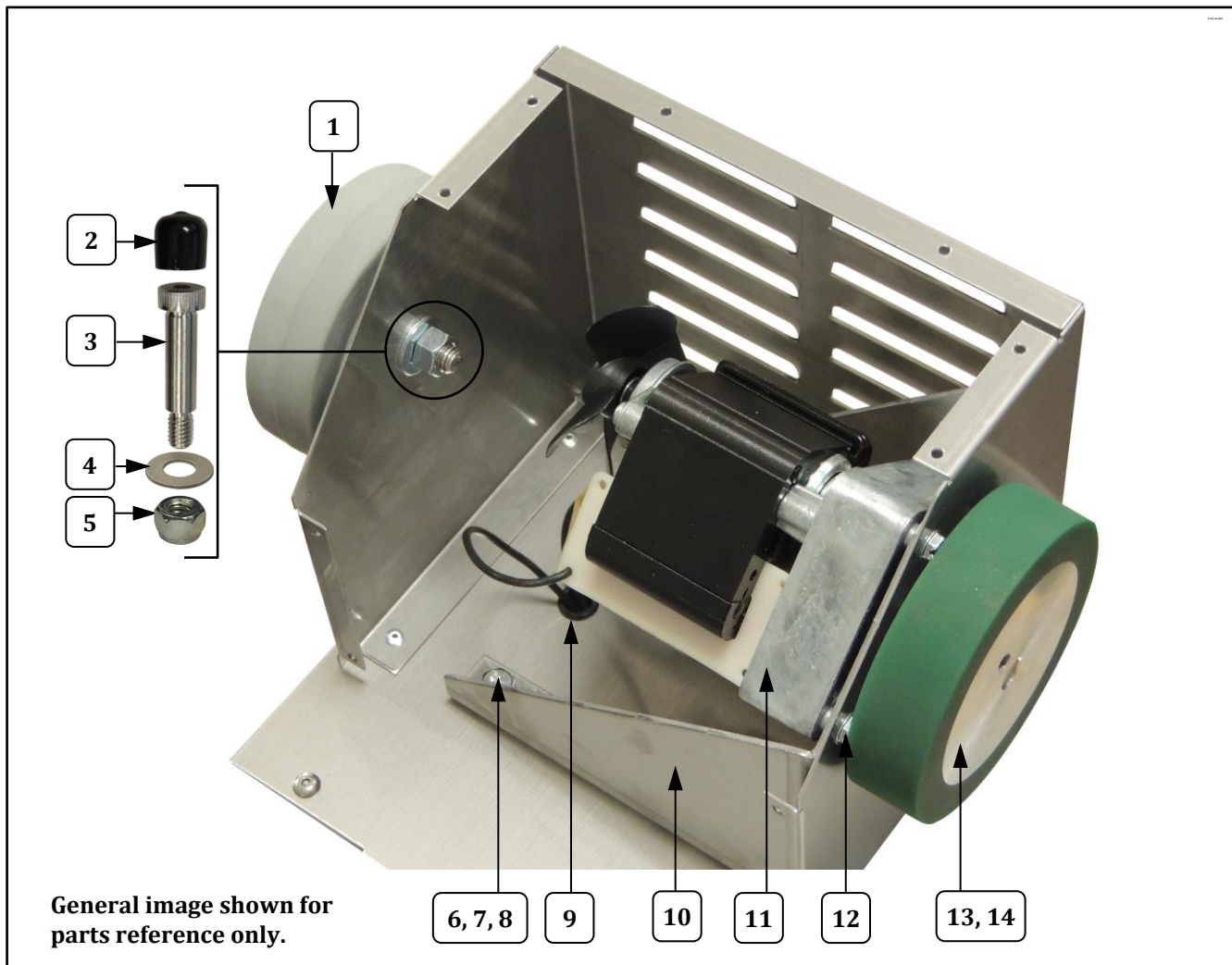

Item	Part Description	Part Number
		2703-00-000
1	IDLER WHEEL	17506
2	CAP	111230
3	1/2"X1-1/2" SHOULDER BOLT	111210
4	3/8" FLAT WASHER, ZINC	111231
5	3/8-16 NYLON LOCKNUT	114032
6	1/4-20X3/4 LG HEX HD BOLT	13164
7	1/4 FLAT WASHER ST. STL	42989
8	HEX NUT 1/4-20 ESLOK	42361
9	BUSHING, SNAP .500 IN	47236
10	MOTOR MOUNT BRACKET	111200
11	DRIVE MOTOR	17651
12	10-32 X 1 UNSL NON-IND	49376
13	DRIVE WHEEL (Set Screw sold separately)	111202
14	SET SCREW, 10-32 X 3/8 (for Drive Wheel)	41994

## Safety Labels

**Unit Labels**

**Power Cord Label**

Item	Part Description	Part Number
		2703-00-000
1	TUMBLER LABEL	111209
2	BURN HAZARD LABEL	111282
3	WARNING, MAX LAMP 250W	54010
4	WARNING LABEL CORD	68720

## Accessories

Item	Part Description	Part Number
		2703-00-000
1	4 CUP GLASS BEAKER W/HAND	111355
2	9-1/2" FLAT BLADE SCRAPER	111244



# Wiring Diagram

## Model No. 2703-00-000

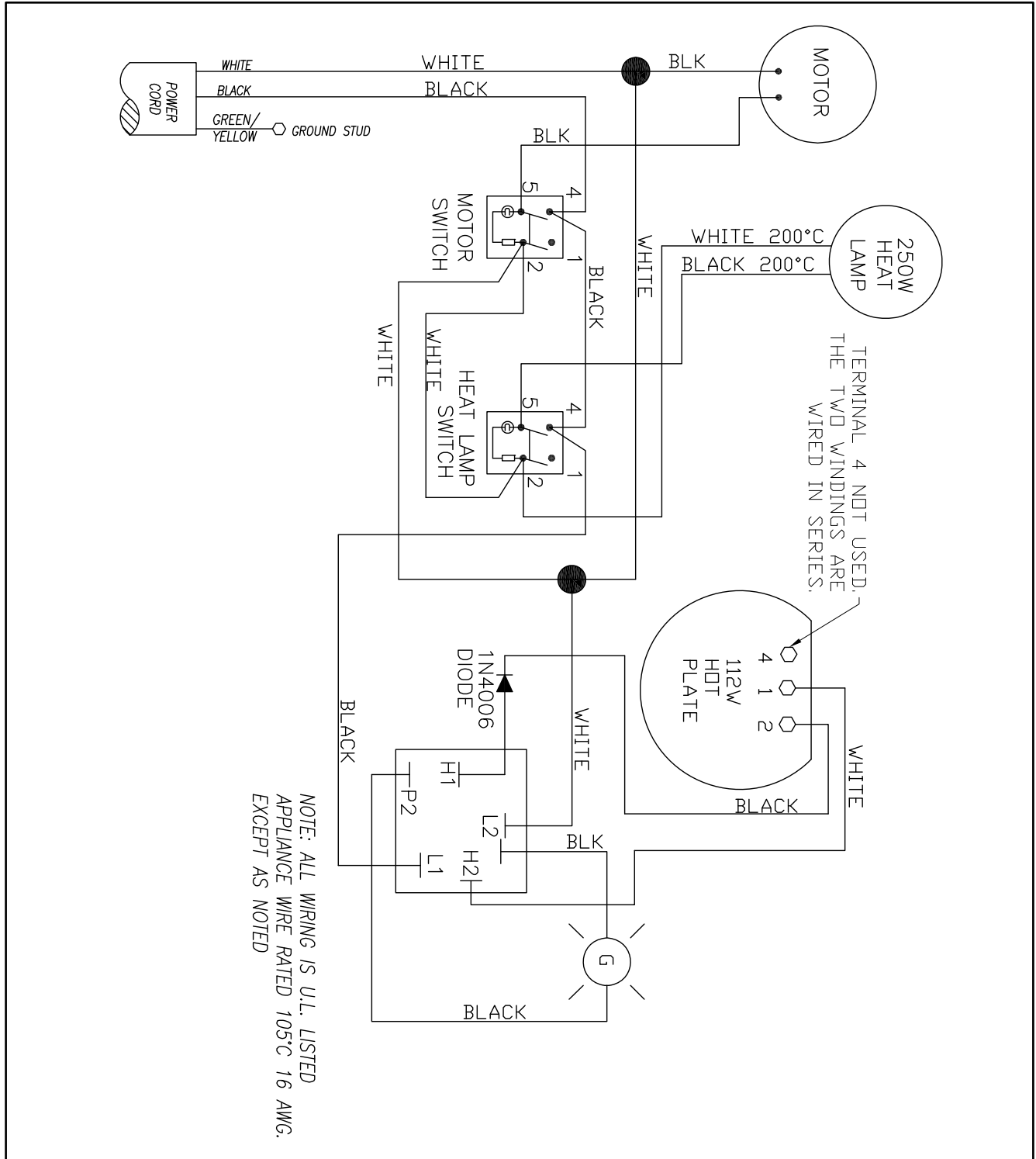



## WARRANTY

Gold Medal Products Co. warrants to the original purchaser each item of its manufacture to be free of defects in workmanship and material under normal use and service. Gold Medal Products Co.'s obligation under this warranty is limited solely to repairing or replacing parts, f.o.b. Cincinnati, Ohio, which in its judgment are defective in workmanship or material and which are returned, freight prepaid, to its Cincinnati, Ohio factory or other designated point. Except for "Perishable Parts" on specific machines, the above warranty applies for a period of two (2) years from the date of original sale to the original purchaser of equipment when recommended operating instructions and maintenance procedures have been followed. These are packed with the machine. Parts warranty is two (2) years, labor is six (6) months.

THIS WARRANTY IS IN LIEU OF ALL OTHER WARRANTIES EXPRESSED OR IMPLIED, AND OF ALL OTHER OBLIGATIONS OR LIABILITIES ON OUR PART, INCLUDING THE IMPLIED WARRANTY OF MERCHANTABILITY. THERE ARE NO WARRANTIES WHICH EXTEND BEYOND THE DESCRIPTION ON THE FACE HEREOF. **THIS WARRANTY DOES NOT APPLY TO THE EQUIPMENT AND SERVICES RELATED TO THE NAYAX CASHLESS PAYMENT SYSTEM AND GOLD MEDAL EXPRESSLY DISCLAIMS ANY AND ALL WARRANTIES RELATED TO THE SAME.** In no event shall Gold Medal Products Co. be liable for special, incidental or consequential damages. No claim under this warranty will be honored if the equipment covered has been misused, neglected, damaged in transit, or has been tampered with or changed in any way. No claim under this warranty shall be honored in the event that components in the unit at the time of the claim were not supplied or approved by Gold Medal Products Co. This warranty is effective only when electrical items have been properly attached to city utility lines only at proper voltages. This warranty is not transferable without the written consent of Gold Medal Products Co.

The term "Original Purchaser" as used in this warranty shall be deemed to mean that person, firm, association, or corporation who was billed by the GOLD MEDAL PRODUCTS CO., or their authorized distributor for the equipment.

THIS WARRANTY HAS NO EFFECT AND IS VOID UNLESS THE ORIGINAL PURCHASER FIRST CALLS GOLD MEDAL PRODUCTS CO. AT 1-800-543-0862 TO DISCUSS WITH OUR SERVICE REPRESENTATIVE THE EQUIPMENT PROBLEM, AND, IF NECESSARY, FOR INSTRUCTIONS CONCERNING THE REPAIR OR REPLACEMENT OF PARTS.

*NOTE: This equipment is manufactured and sold for commercial use only.*



**GOLD MEDAL PRODUCTS CO.**

10700 Medallion Drive, Cincinnati, Ohio 45241-4807 USA

[gmpopcorn.com](http://gmpopcorn.com)

Phone: (800) 543-0862 Fax: (800) 542-1496  
(513) 769-7676 (513) 769-8500