



# Instruction Manual

## BluBear<sup>®</sup> Ice Shaver

Model No. 2747-00-000



**GOLD MEDAL<sup>®</sup> PRODUCTS CO.**

10700 Medallion Drive, Cincinnati, Ohio 45241-4807 USA



# Table of Contents

**SAFETY PRECAUTIONS ..... 3**

**INSTALLATION INSTRUCTIONS ..... 5**

    Inspection of Shipment ..... 5

    Manual ..... 5

    Model Description ..... 5

    Items Included with this Unit ..... 5

    Setup ..... 5

    Electrical Requirements ..... 7

    Before You Plug In Machine ..... 7

**To Align or Install a Shaver Blade ..... 8**

        Inspect Blade Alignment or Change Blade from Ice Chute ..... 8

        Disassemble Unit to Change Blade ..... 10

**Attaching the Optional Ice Hopper Extension ..... 12**

**OPERATING INSTRUCTIONS ..... 13**

    Controls and Their Functions ..... 13

    Ice Requirements ..... 14

    Operating Instructions ..... 14

**Care and Cleaning ..... 15**

        Steps to Disassemble and Reassemble BluBear for Cleaning ..... 15

**Troubleshooting ..... 17**

**—THE FOLLOWING SECTIONS ARE FOR QUALIFIED SERVICE PERSONNEL ONLY— ..... 19**

**MAINTENANCE INSTRUCTIONS ..... 19**

**ORDERING SPARE PARTS ..... 20**

    Cabinet View – Ice Chute and Lid Assembly ..... 21

    Cabinet Exterior and Bottom View ..... 22

    Cabinet Interior – Hopper and Blade View ..... 23



    Cabinet Interior – Electrical Components ..... 24



**Wiring Diagram ..... 25**



**WARRANTY ..... 26**





# SAFETY PRECAUTIONS



	 <b>DANGER</b>
	<p>Machine must be properly grounded to prevent electrical shock to personnel. Failure to do so could result in serious injury, or death. Make sure all machine switches are in the OFF position before plugging the equipment into the receptacle. Keep cord and plug off the ground and away from moisture. Always unplug the equipment before cleaning or servicing. DO NOT immerse any part of this equipment in water. DO NOT use a water jet or excessive water when cleaning.</p> <p style="text-align: right; font-size: small;">008_012221</p>

	 <b>DANGER</b>
	<p>Improper installation, adjustment, alteration, service, or maintenance can cause property damage, injury, or death. Any alterations to this equipment will void the warranty and may cause a dangerous condition. This appliance is not intended to be operated by means of an external timer or separate remote-control system. NEVER make alterations to this equipment. Read the Installation, Operating, and Maintenance Instructions thoroughly before installing, servicing, or operating this equipment.</p> <p style="text-align: right; font-size: small;">014_020416</p>

	 <b>WARNING</b>
	<p>This machinery contains sharp blades. Keep hands and body parts clear at all times.</p> <p style="text-align: right; font-size: small;">037_103114</p>

	 <b>WARNING</b>
	<p>NEVER put your fingers into the shaver body (the goose-neck, ice chute, or hopper). Serious injury may occur.</p> <p style="text-align: right; font-size: small;">017_103114</p>

	 <b>WARNING</b>
	<p>ALWAYS wear safety glasses when servicing this equipment.</p> <p style="text-align: right; font-size: small;">010_010914</p>

	 <b>WARNING</b>
	<p>No user serviceable parts inside. Refer servicing to qualified service personnel.</p> <p style="text-align: right; font-size: small;">011_051514</p>



	<b>! WARNING</b>
	Read and understand operator's manual and all other safety instructions before using this equipment. To order copies of the operator's manual go to <a href="http://gmpopcorn.com">gmpopcorn.com</a> or write to Gold Medal Products Co., 10700 Medallion Drive, Cincinnati, OH 45241 USA 1-(800)-543-0862

022\_060215

	<b>! WARNING</b>
	DO NOT allow direct contact of this equipment by the public when used in food service locations. Only personnel trained and experienced in the equipment operation may operate this equipment. Carefully read all instructions before operation.

012\_010914

	<b>! WARNING</b>
	This machine is NOT to be operated by minors.

007\_010914

	<b>! CAUTION</b>
	If the supply cord is damaged, it must be replaced by Gold Medal Products Co., its service agent or similarly qualified persons in order to avoid a hazard.

039\_080614

**Note:** Improvements are always being made to Gold Medal's equipment. This information may not be the latest available for your purposes. It is critical that you call Gold Medal's Technical Service Department at 1-800-543-0862 for any questions about your machine operations, replacement parts, or any service questions. (Gold Medal Products Co. does not assume any liability for injury due to careless handling and/or reckless operation of this equipment.) General images may be used in manual for reference only.



# INSTALLATION INSTRUCTIONS

## Inspection of Shipment

After unpacking, check thoroughly for any damage which may have occurred in transit. Claims should be filed immediately with the transportation company. The warranty does not cover damage that occurs in transit, or damage caused by abuse, or consequential damage due to the operation of this machine, since it is beyond our control (reference warranty in back of manual).

## Manual

Read and understand the operator’s manual and all other safety instructions before using this equipment. To order copies of the operator’s manual go to [gmpopcorn.com](http://gmpopcorn.com) or write to Gold Medal Products Co., 10700 Medallion Drive, Cincinnati, OH 45241 USA 1-(800)-543-0862.

## Model Description

**2747-00-000:** BluBear Ice Shaver with an attached foot switch. Unit holds approx. 3 lbs. of ice in the hopper. (An optional Ice Hopper Extension, Model 2748-00-000, is available for purchase separately to increase the potential ice holding capacity of the BluBear hopper to approx. 12 lbs.)

## Items Included with this Unit

- Drain Hose (PN [22034](#), order by the foot)
- Hose Clamp (PN [41163](#))
- Manual and Registration/Warranty Card

## Setup

This unit has been tested at the factory.

1. Remove all packaging and tape prior to operation.
2. Place unit on a sturdy, level base which can withstand accidental dripping of water and ice.
3. Connect drain hose to bottom of unit using the hose clamp provided (see Figure A). Drain hose funnels excess water to floor drain or basin tub. When in use, ensure the hose is positioned so water drains appropriately. Drained water is not intended for human consumption.
4. This unit is equipped with an attached foot switch for operating the unit (see Figure B). It should be located so it will not be a trip hazard or in an area of heavy traffic.

	<b>CAUTION</b>
	<p>Failure to use foot switch safely could result in personal injury. Foot switch should only be used where adequate guards or other safety devices are in place for those applications where the use of a foot switch could cause personal injury.</p>



- Do not leave foot switch accessible to inadvertent operation when left unattended or when not being used.
  - Turn Power Switch OFF when ice shaver is not in use.
  - Do not bypass any machine or equipment safety features to use this foot switch.
  - Replace damaged cord immediately.
  - It is the responsibility of the user to comply with federal, state and local safety and health regulations.
5. **Prior to initial use of a new unit**, the shaver blade alignment should be checked to ensure it did not move during shipment (reference section To Align or Install a Shaver Blade for inspection and alignment instructions).
  6. If you have the optional Ice Hopper Extension (Model 2748-00-000, available for purchase separately), reference section Attaching the Optional Ice Hopper Extension for installation instructions (or reference the instructions included with the unit).
  7. After setup, the unit should be cleaned prior to use (see Care and Cleaning section).

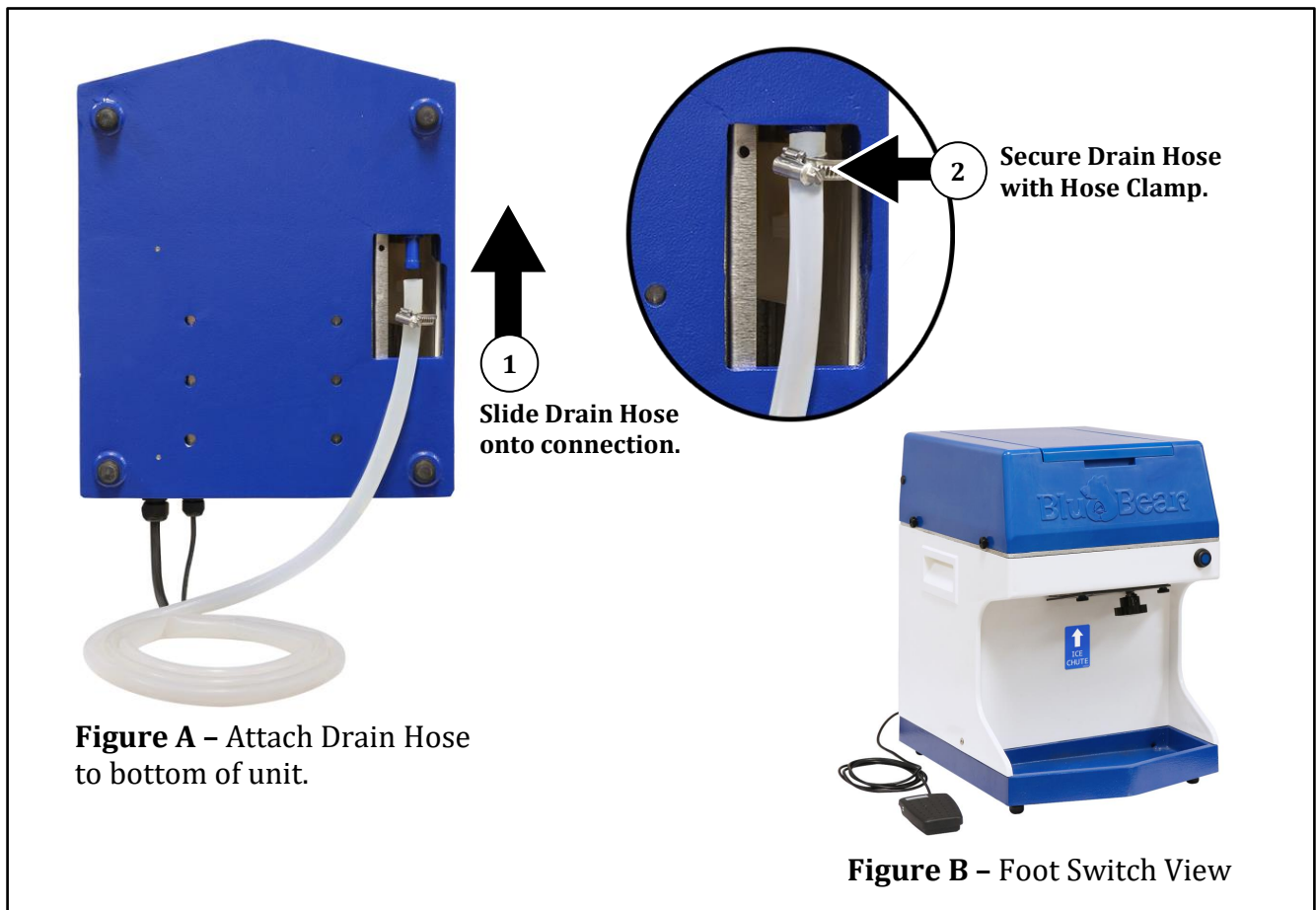





## Electrical Requirements

The following power supply must be provided (reference unit Data Plate for Wattage requirement):

**120 V~, 60 Hz**

	 <b>DANGER</b>
	<p>Machine must be properly grounded to prevent electrical shock to personnel. Failure to do so could result in serious injury, or death.                  Make sure all machine switches are in the OFF position before plugging the equipment into the receptacle. Keep cord and plug off the ground and away from moisture. Always unplug the equipment before cleaning or servicing.                  DO NOT immerse any part of this equipment in water.                  DO NOT use a water jet or excessive water when cleaning.</p> <p style="text-align: right; font-size: small;">008_012221</p>



A certified electrician must furnish sufficient power for proper machine operation and install any supplied receptacle (reference unit Data Plate for model specific Volts AC, Hertz, and Wattage requirements). We recommend this equipment be on a dedicated and protected circuit. Failure to wire properly will void the warranty and may result in damage to the machine. It is Gold Medal Products Co.'s recommendation that this machine be plugged directly into a wall outlet. The use of extension cords is not recommended due to safety concerns, and may cause sacrificed and/or reduced performance. Make sure cord is located to prevent a trip hazard or unit upset. Units with an IEC Power Cord - make sure the IEC cord is properly seated into the IEC receptacle before powering up the machine.

## Before You Plug In Machine

1. Make sure all machine switches are OFF before plugging equipment into receptacle.
2. Make sure wall outlet can accept the grounded plugs (where applicable) on the power supply cord.
3. The wall outlet must have the proper polarity. If in doubt, have a competent electrician inspect the outlet and correct if necessary.
4. **DO NOT** use a grounded to un-grounded receptacle adapter (where applicable).
5. Install unit in a level position.

	 <b>CAUTION</b>
	<p>If the supply cord is damaged, it must be replaced by Gold Medal Products Co., its service agent or similarly qualified persons in order to avoid a hazard.</p> <p style="text-align: right; font-size: small;">039_080614</p>

# To Align or Install a Shaver Blade

	 <b>WARNING</b>
<p>This machinery contains sharp blades. Keep hands and body parts clear at all times.</p>	
<p>037_103114</p>	

The section describes the procedure to check the alignment or to replace the shaver blade. **Prior to initial use of a new unit**, the shaver blade alignment should be checked to ensure it did not move during shipment (reference Inspect Blade Alignment section below).

ALWAYS turn the ice shaver OFF and unplug it from the power supply before inspecting or replacing the blade. Use a flashlight to examine the blade in the shaver body. If the blade appears to be nicked or bent, then it should be replaced. Gold Medal recommends that a spare blade be kept on hand.

The blade can be inspected or replaced by removing the ice chute to access the blade or the unit can be disassembled to remove the hopper with the blade assembly attached.

## Inspect Blade Alignment or Change Blade from Ice Chute

**Step 1:** Turn ice shaver power switch OFF and unplug unit before proceeding.

**Step 2:** Remove ice chute by removing the 3 thumb screws (see Figure A); set ice chute aside so its non-stick coating does not get scratched.

Blade can be accessed with Ice Chute removed.

Use caution when removing or assembling parts of the unit, the blade is extremely sharp.



**Figure A - Removing Ice Chute**



**Step 3: INSPECT or REMOVE Blade**

**TO INSPECT BLADE** - View the shaver blade (see Figure B); make sure blade is aligned evenly on the blade assembly and the thumb screws are securely fastened. (If blade is **loose or out of alignment**, set thumb screws finger tight **ONLY**, then continue to Step 5.)

**(3) Thumb Screws**  
(fastens Blade)

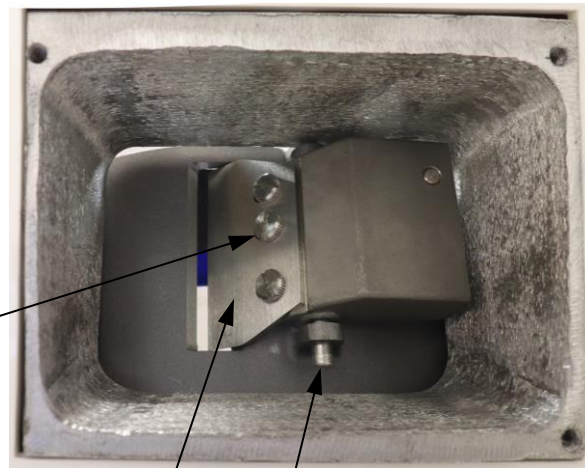

**Align Blade with mounting holes.**      **Pivot Rod** (e-ring end of rod must face **OUTWARD** when installed)

**Figure B - Blade Assembly View**

**TO REPLACE BLADE** - Remove blade by removing the 3 thumb screws (see Figure B); set screws aside for reuse. (Blade may be sharpened for reuse.)

**Step 4:** Align new blade with blade mounting holes - **all 3 holes MUST align** to ensure blade is installed in correct orientation, then reinsert the thumb screws until finger tight **ONLY**.

**Shaver Blade**  
**Use a height gauge to set blade evenly.**

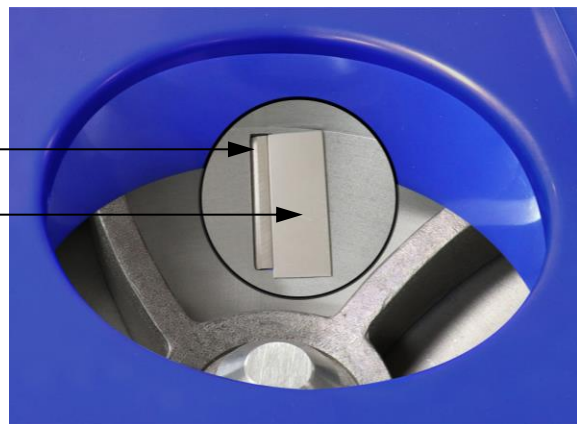

**Figure C - Hopper Interior View**

**Step 5:** Open top cover lid to view the blade inside the hopper (see Figure C).

**Step 6:** Set blade height to .050" (1.27 mm) using a height gauge (thickness of a dime) (see Figure C and D). Make sure the height is set evenly across the blade.

**Step 7:** Tighten the blade thumb screws completely. Check blade height again to ensure blade did not move while tightening screws.

**Step 8:** Remove height gauge and reattach the ice chute.

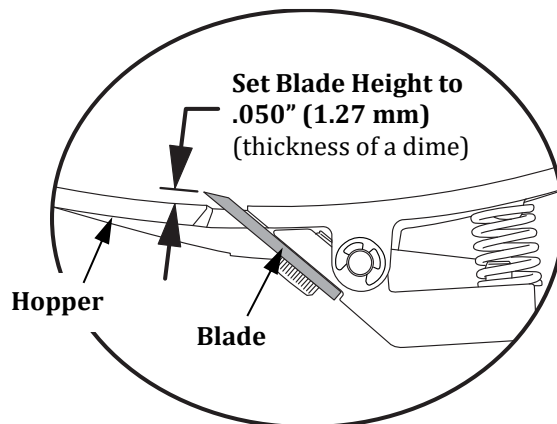

**Figure D - Set Blade Height** (cut-away view)



## Disassemble Unit to Change Blade

**Step 1:** Turn ice shaver power switch OFF and unplug unit before proceeding.

**Step 2:** Remove top cover by removing the 4 thumb screws (see Figure A).

**Use caution when removing or assembling parts of the unit, the blade is extremely sharp.**

**Step 3:** Remove splash cover by removing the 4 thumb screws.

**Step 4:** Remove impeller nut (turn CCW to remove).

**Note:** Impeller nut has a captured o-ring, if it comes out of the groove, put it back in.

**Step 5:** Lift top funnel and impeller off unit.

**Step 6:** Remove the hopper with blade assembly from unit. (Blade is attached on underside of hopper).

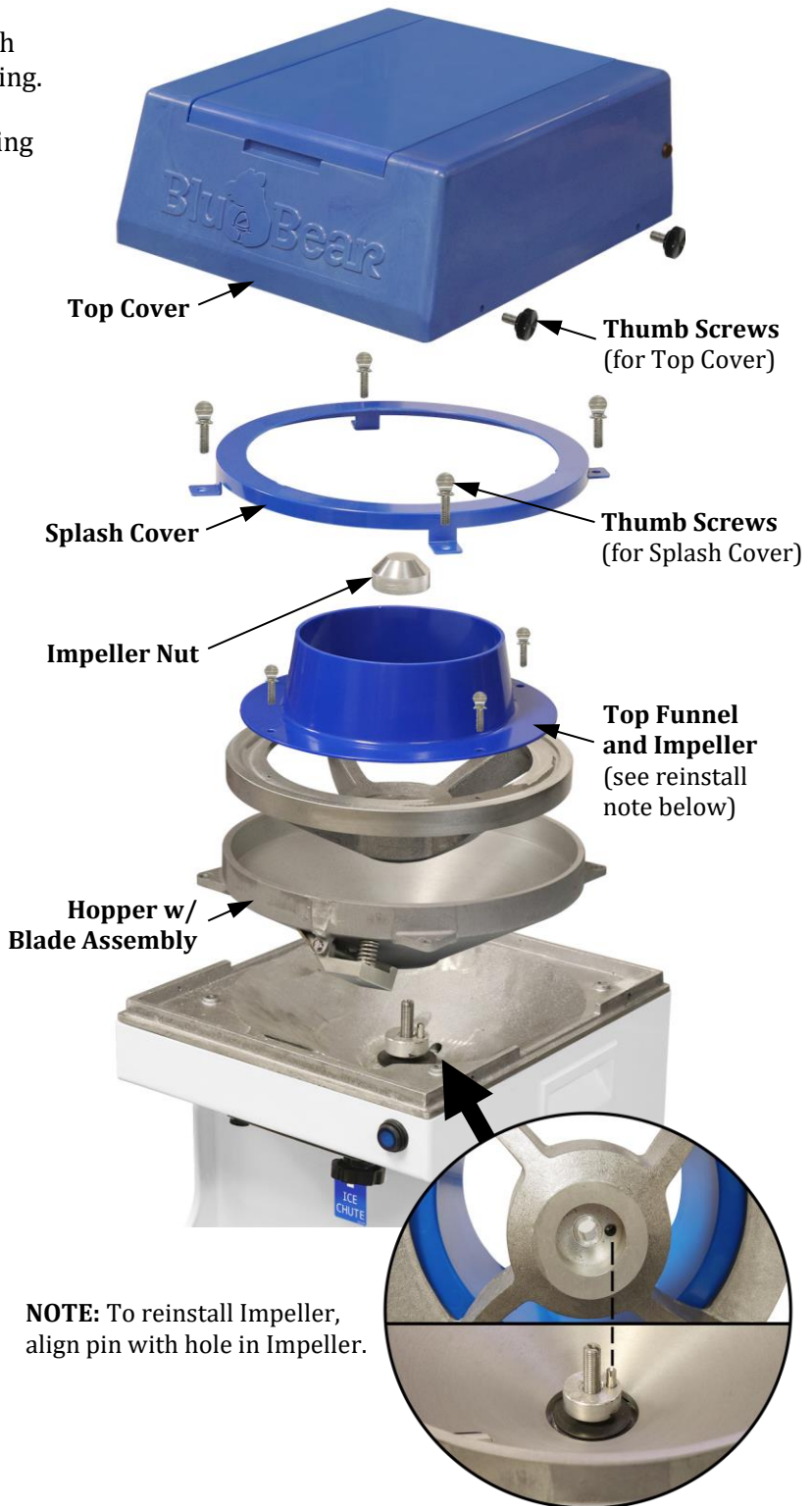

**NOTE:** To reinstall Impeller, align pin with hole in Impeller.

**Figure A - Parts to Disassemble.**



**Step 7:** Remove shaver blade by removing the 3 thumb screws (see Figure B); set screws aside for reuse. (Blade may be sharpened for reuse.)

**Step 8:** Align new blade with blade mounting holes - **all 3 holes MUST align** to ensure blade is installed in correct orientation, then reinsert the thumb screws until finger tight **ONLY**.

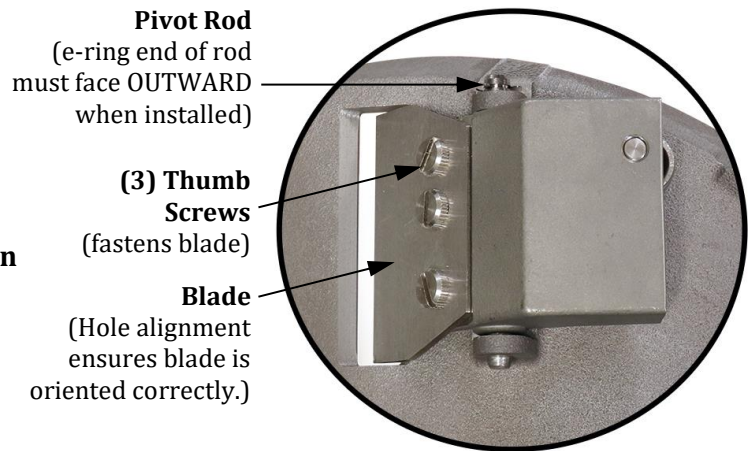

**Figure B - Blade Assembly View**

**Step 9:** Set blade height to .050" (1.27 mm) using a height gauge (thickness of a dime) (see Figure C and D). Make sure the height is set evenly across the blade.

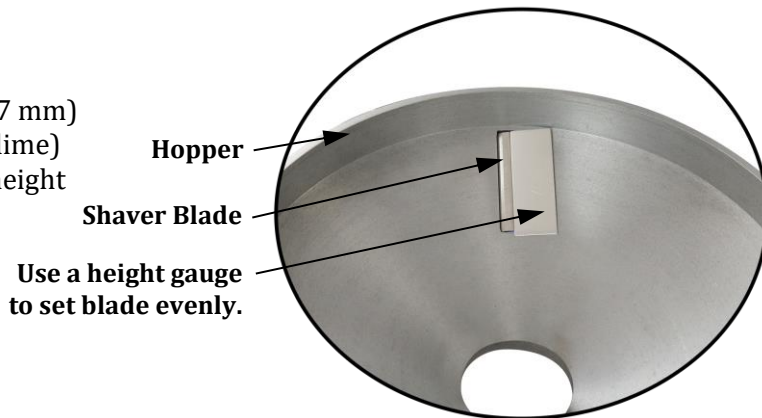

**Figure C - Set Blade Height (Hopper view)**

**Step 10:** Tighten the blade thumb screws completely. Check blade height again to ensure blade did not move while tightening screws.

**Step 11:** Remove height gauge and reassemble unit in reverse order.

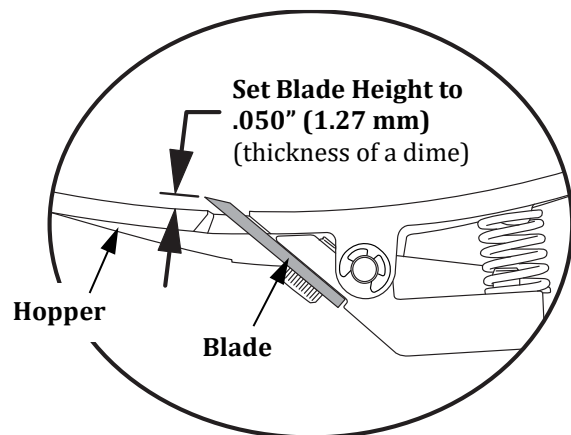

**Figure D - Set Blade Height (cut-away view)**



# Attaching the Optional Ice Hopper Extension

The optional Ice Hopper Extension (Model 2748-00-000) is available for purchase separately to increase the potential ice holding capacity of the BluBear hopper to approx. 12 lbs. Follow the instructions below to install the hopper extension (or reference the instructions included with the unit).

**Important: Do Not Drop.** Ice chute is made of an acrylic material—handle with care.

**Step 1:** Turn ice shaver power switch OFF and unplug unit before attempting to install the Ice Hopper Extension.

**Step 2:** Remove top cover by removing the 4 thumb screws (save for reuse), then lift top cover off unit.



Remove 4 Thumb Screws then remove Top Cover.

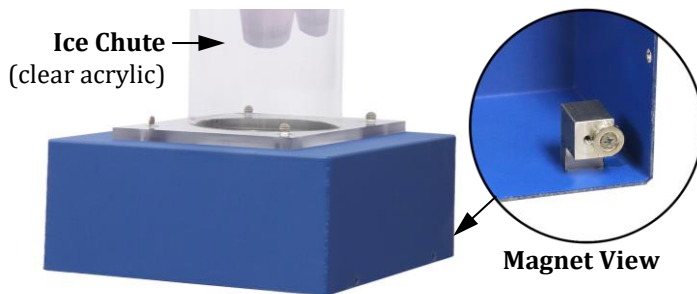

Ice Chute (clear acrylic)

Magnet View



Lid Momentary Switch Location

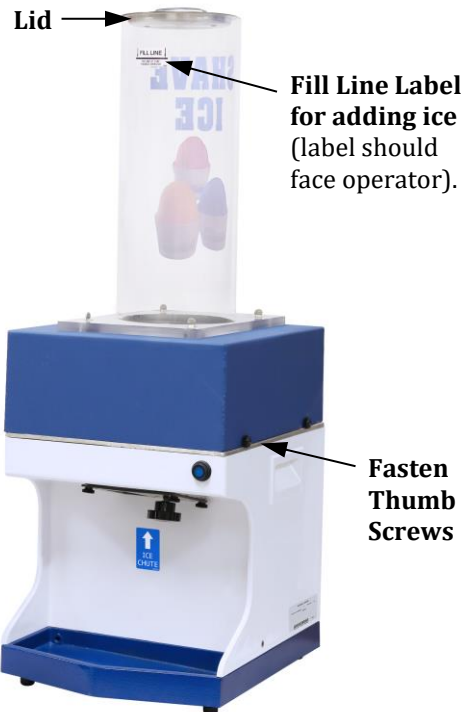

Fill Line Label for adding ice (label should face operator).

Fasten Thumb Screws

**Step 3:** Align Ice Hopper Extension with ice shaver – MAKE SURE the magnet is positioned over the lid momentary switch.

BluBear **WILL NOT WORK** if hopper extension is not positioned to engage the lid momentary switch.

**Step 4:** Re-fasten the 4 thumb screws to secure.

**To use:** Add ice to Fill Line (indicted on label) then put lid on tube.



# OPERATING INSTRUCTIONS

## Controls and Their Functions

### MAIN POWER SWITCH

Lighted Push Button Switch – supplies power to the foot switch (the lid must be CLOSED for the foot switch to operate). Blue switch light ON, indicates there is power to the unit.

### FOOT SWITCH

Press the foot switch to operate the unit (the lid must be CLOSED for the foot switch to operate).

### LID MOMENTARY SWITCH

Lid Momentary Switch must be engaged for unit to operate. (The lid must be CLOSED for the lid magnet to engage the lid momentary switch; opening the lid removes power to the foot switch.)

### BLADE ADJUSTMENT KNOB

Adjusts the blade height to change the ice texture.

- Turn knob clockwise (CW) for a finer ice texture.
- Turn knob counter-clockwise (CCW) for a coarser ice texture.

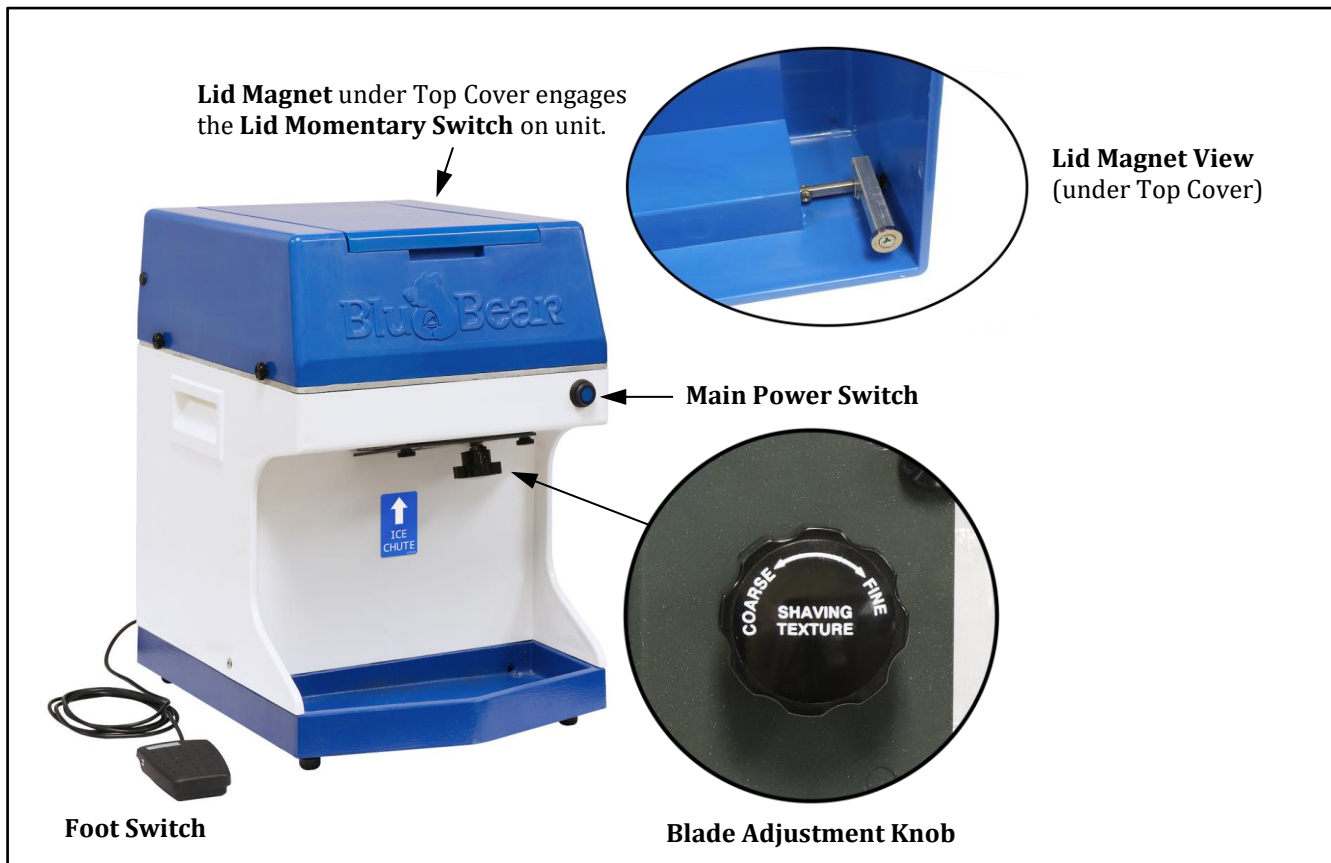



## Ice Requirements



The BluBear Ice Shaver can accept ice cubes or block ice (if broken into pieces approximately 2 to 3 inches in size). **The ice will not enter the shaving chute if the pieces are too large.**

## Operating Instructions

1. Allow ice to soften at least 1 hour in an ice cooler before use. Using ice straight from the freezer affects the quality of the shaved ice and can damage the shaver blade.
2. Lift cover lid and load ice cubes into the hopper to within 1/2" of the top – be sure the ice is loaded evenly in hopper.  
**Note:** NEVER allow any foreign or metallic objects around the shaver area. Ice picks, scoops, and debris that may be in the ice can damage the blade.
3. Close the lid and turn the Main Power Switch ON. **Machine WILL NOT OPERATE unless the cover lid is closed** (lid snaps shut when pushed completely closed).  
**Note:** When refilling the hopper with ice – opening the cover lid shuts power to the foot switch OFF.
4. Hold a cup directly below the ice chute and press down on the Foot Switch. To stop ice shaving, release the Foot Switch.
5. To adjust the ice texture, turn the Blade Adjustment Knob CW for a finer ice texture, CCW for a coarser ice texture.
6. Turn Power Switch OFF when ice shaver is not in use.

# Care and Cleaning

	 <b>DANGER</b>
	<p>Machine must be properly grounded to prevent electrical shock to personnel. <b>DO NOT immerse in water.</b> DO NOT clean appliance with a water jet or steam cleaner. Always unplug the equipment before cleaning or servicing. 025_051321</p>

	 <b>WARNING</b>
	<p>This machinery contains sharp blades. Keep hands and body parts clear at all times. 037_103114</p>

Good sanitation practice demands that all food preparation equipment be cleaned regularly (only use non-toxic, food grade cleaners). A clean looking, well-kept machine is one of the best ways of advertising your product.

Unit surfaces are designed to help prevent ice buildup during use. **DO NOT use abrasive materials or cleaners as they will damage parts of machine/non-stick surfaces.** Ammonia cleaners will damage plastic panels, only use a non-ammonia cleaner.

## Steps to Disassemble and Reassemble BluBear for Cleaning

Follow the directions below to clean the unit.

**Step 1:** Run ice shaver to empty all ice from unit.

**Step 2:** Turn ice shaver OFF and unplug it from the power source before attempting to clean the unit.

**Step 3:** Remove top cover by removing the 4 thumb screws (see Figure A).

**Use caution when removing or assembling parts of the unit, the blade is extremely sharp.**



Figure A

**Step 4:** Remove splash cover by removing the 4 thumb screws (see Figure B).

**Step 5:** Remove impeller nut (turn CCW to remove).

**Note:** Impeller nut has a captured o-ring, if it comes out of the groove, put it back in. O-ring does not need to be removed for cleaning and does not need lubrication.

**Step 6:** Lift top funnel and impeller off unit. (As needed, remove the small thumb screws to separate funnel from impeller.)

**Step 7:** Take items removed to sink to clean with soap and water, then rinse and allow to dry.

**Step 8:** Remove the hopper with blade assembly from unit and take it to sink to rinse clean, then allow to air dry.

**Step 9:** Remove ice chute from front of unit by removing the 3 thumb screws (see Figure C). Ice chute has a non-stick coating, **do not use abrasives to clean.**

**Step 10:** Slowly pour a cup of clean water into the drainage bin to be sure the drain hoses are clear, then use a clean, dry cloth to wipe out the bin.

**Step 11:** Wipe clean the **exterior** surfaces of the unit using a clean, **SLIGHTLY** damp cloth (cloth may be **SLIGHTLY** dampened with soap and water, then wipe again with clean water to remove any remaining cleaner).

**Step 12:** Once dry, reassemble unit in reverse order.

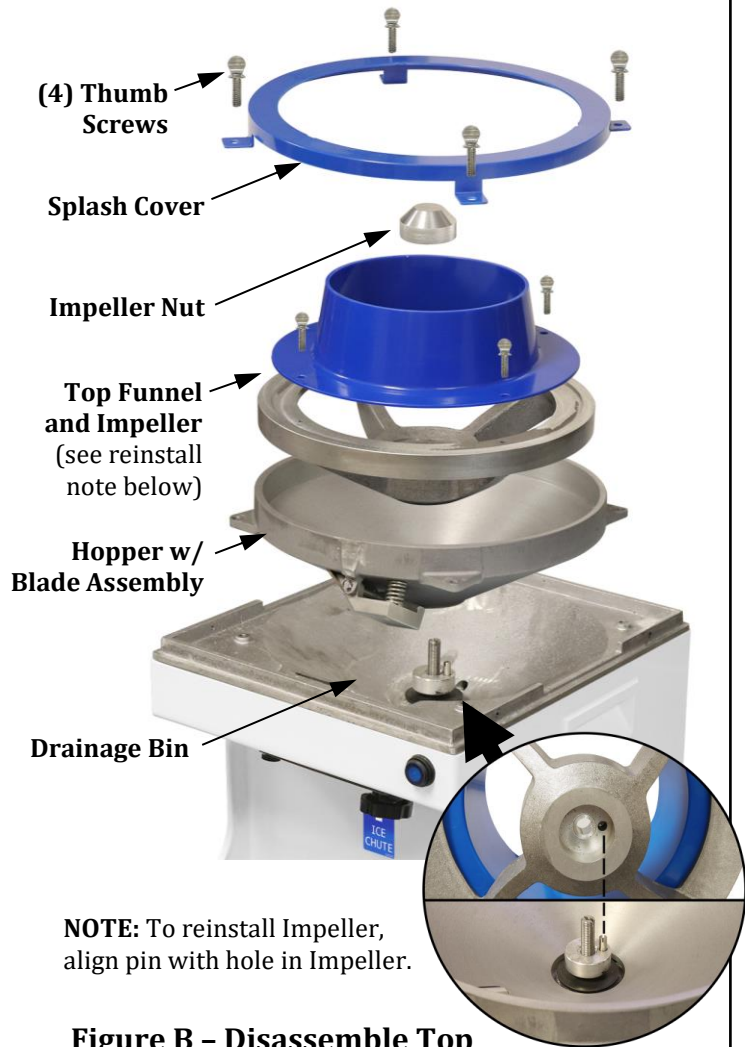

**NOTE:** To reinstall Impeller, align pin with hole in Impeller.

**Figure B - Disassemble Top**

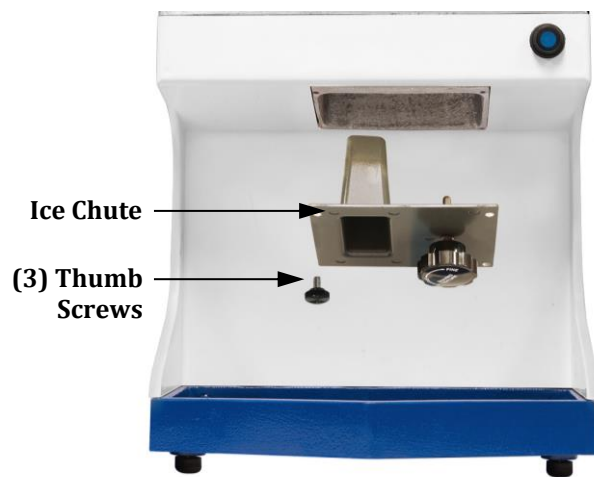

**Figure C - Disassemble Ice Chute**



# Troubleshooting

Issue	Possible Cause	Solution
<p><b>Unit Does Not Operate</b></p>	<p>A. No power to unit.</p> <p>B. Power Switch</p> <p>C. Lid open - Momentary Switch</p> <p>D. Foot Switch</p>	<p>A. Make sure the unit’s power cord is plugged in.</p> <p>Units with and IEC cord - make sure the IEC Power Cord is properly seated into the IEC receptacle before powering up the machine.</p> <p>B. Make sure the Main Power Switch is ON, the blue LED light should be on. If the switch is on, but the LED does not turn on, the switch may be defective. Contact a qualified service person for inspection/repair.</p> <p>C. The lid must be CLOSED for the unit to operate. If the lid is closed, but the unit still does not operate the lid momentary switch may need to be serviced. Contact a qualified service person for inspection/repair.</p> <p>Units with the optional Ice Hopper Extension – make sure the hopper extension is positioned so the sensor magnet engages the ice shaver’s lid momentary switch (reference section Attaching the Optional Ice Hopper Extension).</p> <p>D. Ensure the foot switch can be pressed correctly, make sure there is no interference. If the switch can be pressed, but the unit still does not operate, the foot switch may need to be serviced. Contact a qualified service person for inspection/repair.</p>
<p><b>Ice Texture/Unit Not Shaving Ice</b></p>	<p>A. Adjustment Knob/Blade Alignment</p> <p>B. Blade Assembly Pivot Rod orientation</p>	<p>A. Ice texture is too fine or too coarse. Use the Adjustment knob located on the ice chute to adjust the ice texture. Turn knob CW for finer ice; turn knob CCW for coarser ice. Reference the Blade Adjustment Knob description in the Controls and Their Functions section.</p> <p>If turning the adjustment knob does not correct the ice texture or if the unit is still not shaving ice, then check the blade alignment to make sure the blade is not loose or out of alignment (reference section To Align or Install a Shaver Blade in the Installation section of this manual).</p> <p>B. Vibration may cause the pivot rod (which holds the blade assembly to the hopper) to shift. Ensure the pivot rod is inserted so the e-ring end faces OUTWARD (e-ring holds rod in place when hopper is installed in unit). Reference section To Align or Install a Shaver Blade in the Installation section of this manual.</p>







<b>Water Does Not Drain</b>	A. Drain hose clogged or pinched. B. Not enough drop in the hose for water to drain.	A. Ensure drain hose is clear and it is not pinched closed in any area. B. Make sure hose is positioned downward enough to allow water to drain away from the unit.
-----------------------------	---	--





—THE FOLLOWING SECTIONS ARE FOR QUALIFIED SERVICE PERSONNEL ONLY—

# MAINTENANCE INSTRUCTIONS

	 <b>DANGER</b>
	<p>Machine must be properly grounded to prevent electrical shock to personnel. Failure to do so could result in serious injury, or death. Make sure all machine switches are in the OFF position before plugging the equipment into the receptacle. Keep cord and plug off the ground and away from moisture. Always unplug the equipment before cleaning or servicing. DO NOT immerse any part of this equipment in water. DO NOT use a water jet or excessive water when cleaning.</p> <p style="text-align: right; font-size: small;">008_012221</p>

	 <b>DANGER</b>
	<p>Improper installation, adjustment, alteration, service, or maintenance can cause property damage, injury, or death. Any alterations to this equipment will void the warranty and may cause a dangerous condition. This appliance is not intended to be operated by means of an external timer or separate remote-control system. NEVER make alterations to this equipment. Read the Installation, Operating, and Maintenance Instructions thoroughly before installing, servicing, or operating this equipment.</p> <p style="text-align: right; font-size: small;">014_020416</p>

	 <b>WARNING</b>
	<p>No user serviceable parts inside. Refer servicing to qualified service personnel.</p> <p style="text-align: right; font-size: small;">011_051514</p>

	 <b>CAUTION</b>
	<p>THE FOLLOWING SECTIONS OF THIS MANUAL ARE INTENDED ONLY FOR QUALIFIED SERVICE PERSONNEL WHO ARE FAMILIAR WITH ELECTRICAL EQUIPMENT. THESE ARE NOT INTENDED FOR THE OPERATOR.</p> <p style="text-align: right; font-size: small;">027_010914</p>



---

## ORDERING SPARE PARTS

1. Identify the needed part by checking it against the photos, illustrations, and/or parts list. (General images may be used in manual for reference only.)
2. Use only approved replacement parts when servicing this unit.
3. When ordering, please include part number, part name, and quantity needed.
4. Please include your model number, serial number, and date of manufacture (located on the machine nameplate/data plate) with your order.
5. Address all parts orders to Parts Department, Gold Medal Products Co., 10700 Medallion Drive, Cincinnati, Ohio 45241-4807

or place orders by phone or online:

Phone: (800) 543-0862  
(513) 769-7676

Fax: (800) 542-1496  
(513) 769-8500

E-mail: [info@gmpopcorn.com](mailto:info@gmpopcorn.com)  
Web Page: [gmpopcorn.com](http://gmpopcorn.com)

## Cabinet View – Ice Chute and Lid Assembly

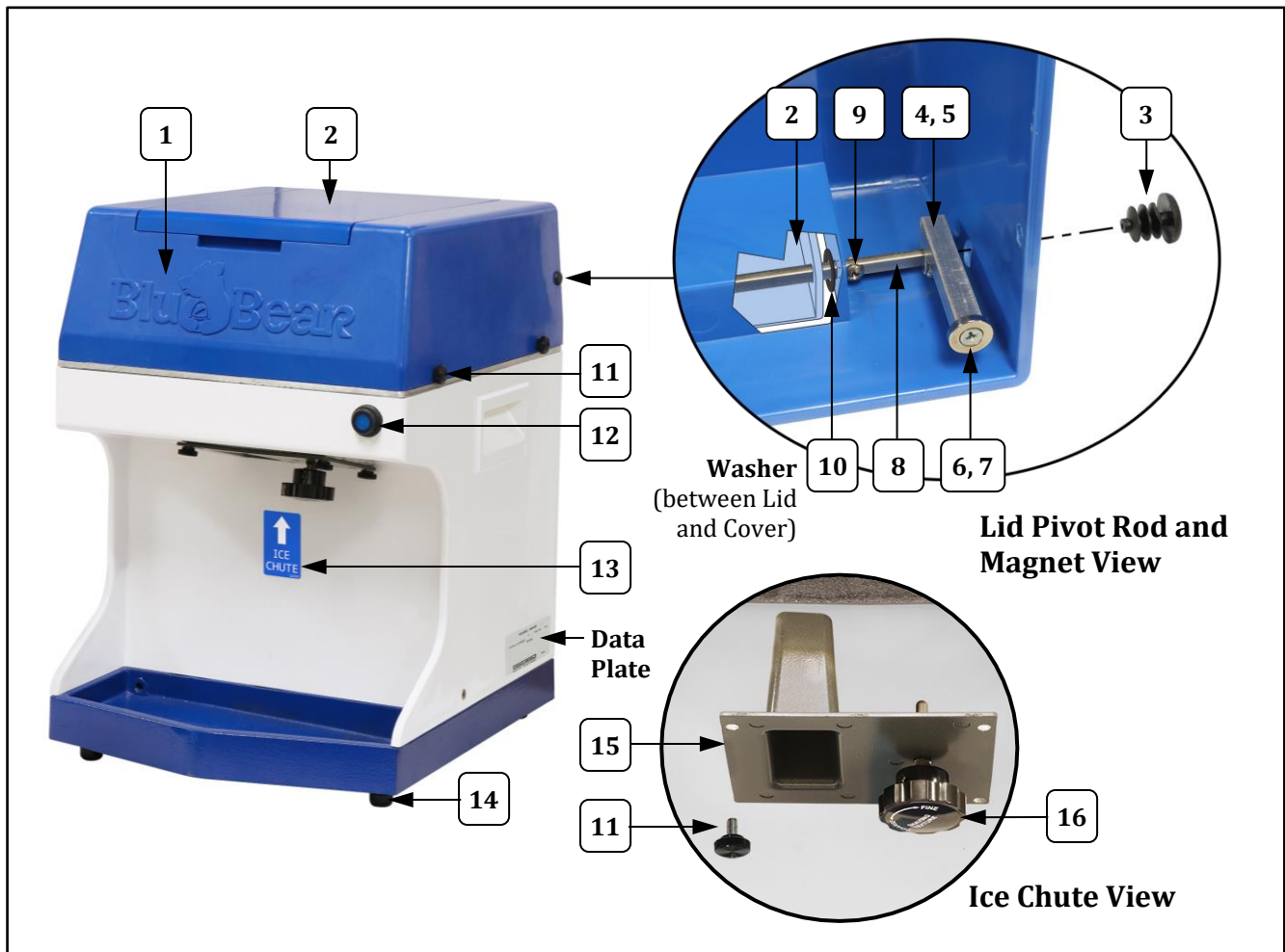

Item	Part Description	Part Number
		2747-00-000
1	BLUBEAR TOP COVER	115175
2	BLUBEAR ICE LID	115176
3	PLUG, PLASTIC .32 DIA	115229
4	BLUBEAR MAGNET HOLDER	115178
5	8-32 X 3/16 PHIL PAN M.S. (fastens holder to rod)	<a href="#">79286</a>
6	MAGNET USES 8 FLT HD SC	<a href="#">50013</a>
7	8-32X3/8 FL HD PH MS	<a href="#">20065</a>
8	BLUBEAR ICE LID PIVOT ROD	115036
9	10-24 X 1/4 P/H PHIL	<a href="#">12469</a>
10	.25X.375X.031 NYLON WASHER (1 required on each side of lid)	115228
11	10-24X3/8BLACK THUMBSCREW	115236
12	PUSHBUTTON SWITCH	118039
13	ICE CHUTE LOCATION LABEL	115233
14	RUBBER BUMPER/FOOT	<a href="#">87247</a>
15	BLUBEAR ICE CHUTE	115166
16	BLUBEAR KNOB ASSEMBLY	115168



## Cabinet Exterior and Bottom View

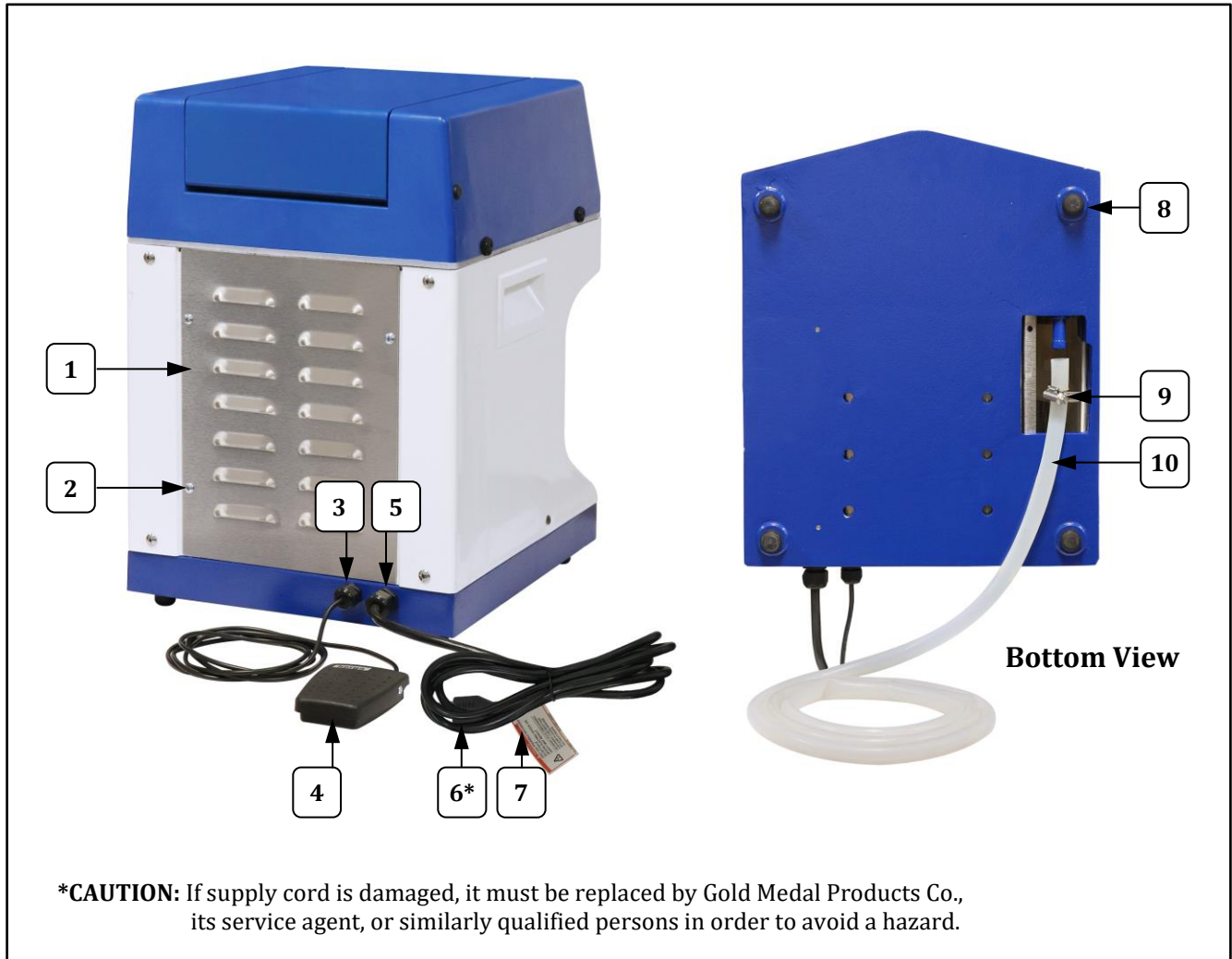

Item	Part Description	Part Number
		2747-00-000
1	BLUBEAR REAR COVER	115187
2	10-24 X 1 HEX MACH SCREW	49322
3	EXT STRAIN RELIEF SM	115223
4	FOOT SWITCH, BLUBEAR	115218
5	EXT STRAIN RELIEF LG	115224
6*	POWER SUPPLY CORD 15 AMP	22038
7	WARNING LABEL CORD	68720
8	RUBBER BUMPER/FOOT	87247
9	HOSE CLAMP W/SCREW	41163
10	DRAIN HOSE 3/8 ID 1/16 W (sold by the foot)	22034



## Cabinet Interior – Hopper and Blade View

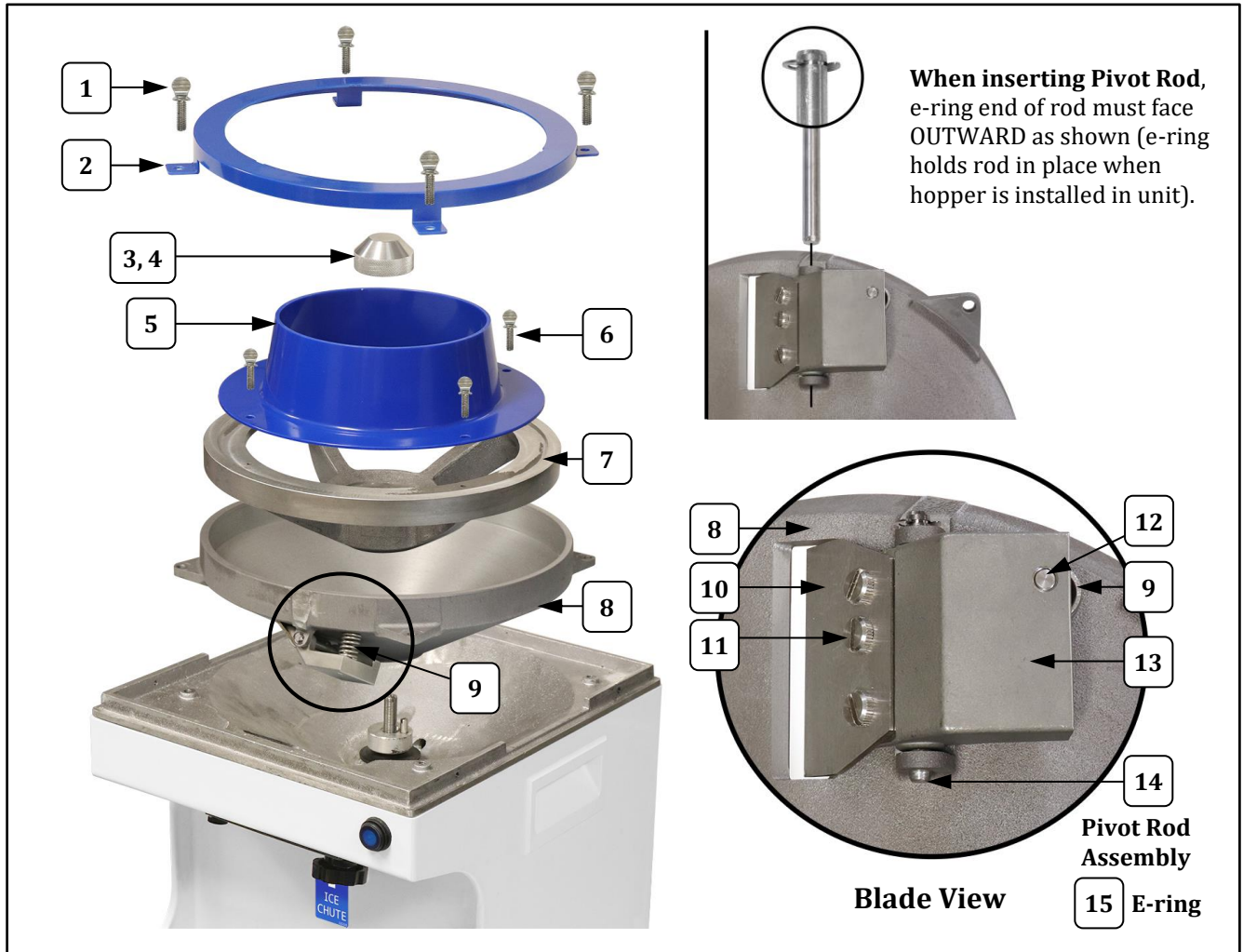

Item	Part Description	Part Number
		2747-00-000
1	1/4-20 X 1/2 THUMB SCREW (fastens Splash Cover)	61059
2	BLUBEAR SPLASH COVER	115174
3	BLUBEAR IMPELLER NUT	115556
4	1 3/16 OD RUBBER O-RING (for Impeller Nut)	115179
5	BLUBEAR TOP FUNNEL	115029
6	THUMB SCREW 10-32 X 3/8 (fastens Funnel)	12123
7	BLUBEAR IMPELLER-MACHINED	115164
8	BLUBEAR HOPPER-FINISHED	115162
9	SPRING COMPRESSION S.S.	12117
10	BLADE	12094
11	THUMB SCREW 10-32 X 3/8 (fastens Blade)	12158
12	STUD - SPRING RETAINER	12143
13	BLUBEAR BLADE HOLDER	115033
14	BLUBEAR PIVOT ROD ASSY (includes e-ring)	115249
15	E-RING .437OD .185ID (for Pivot Rod)	115264



## Cabinet Interior – Electrical Components

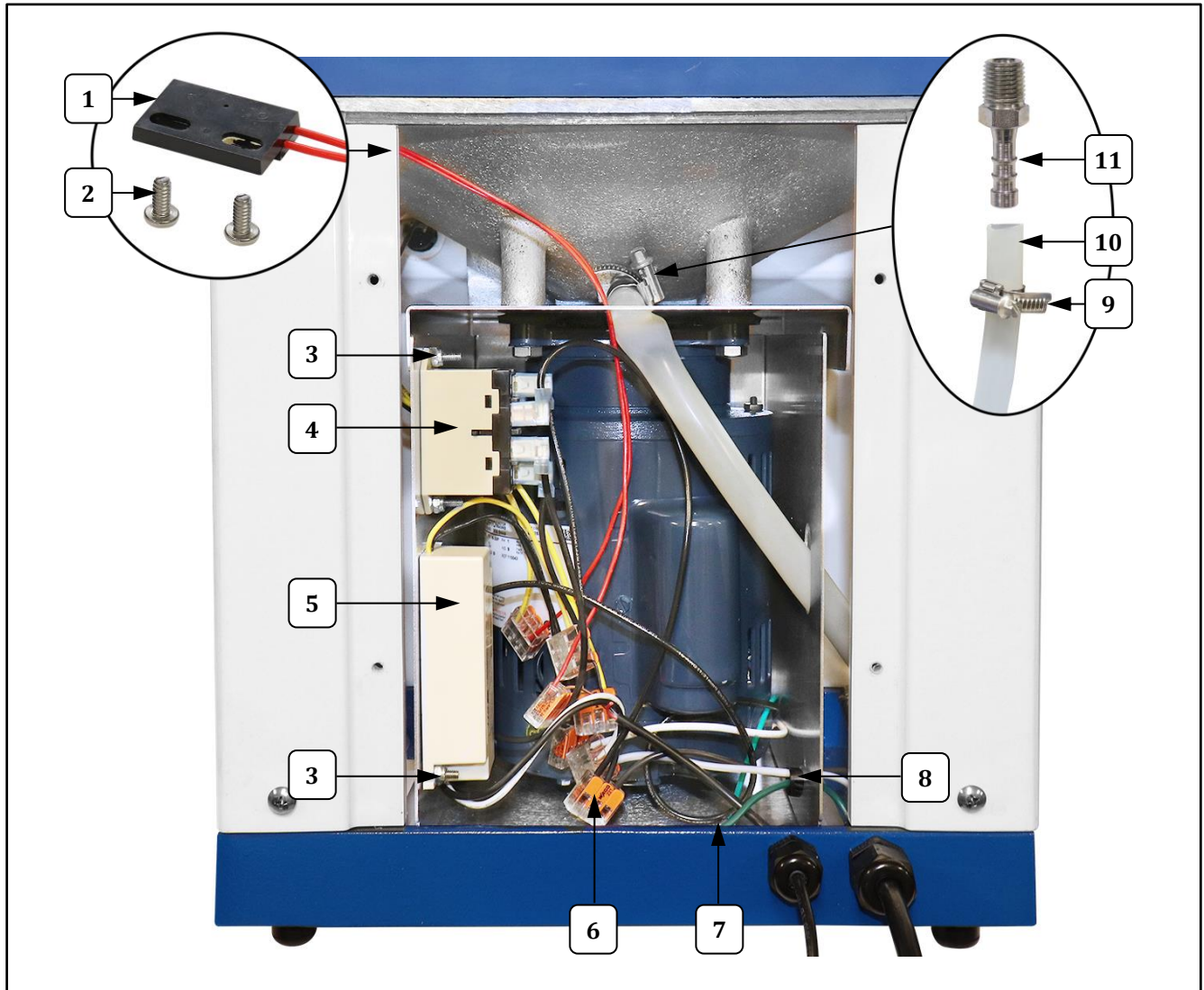

Item	Part Description	Part Number
		2747-00-000
1*	REED SW SPST W 12IN LEADS (Lid Momentary Switch)	118040
2	4-40 X 1/4 SS SCREW	114307
3	6-32 HEX NUT ZINC PLATED	38005
4	RELAY SPST 30A 12VDC	55432
5	POWER SUPPLY, 12VDC	55231
6	3 POSITION WIRE CONNECTOR	55244
7	SCREW #8-32X1/4 PAN HD PH	74142
8	BUSHING, SNAP .500 IN	47236
9	HOSE CLAMP 7/16in - 1/2in	67843
10	PLASTIC FOOD TUBING (sold by the foot, 18" length recommended for use in unit)	91375
11	1/4NPT HOSE BARB 5/16ID	115041



# Wiring Diagram

## Model No. 2747-00-000

WIRE	COLOR	AWG	FROM	TERMINAL 'A'	TO	TERMINAL 'B'	LENGTH
1	BR	18	CON2	STRIP	R1.4	1/4" FEMALE FASTON	10
2	BR	18	CON2	STRIP	R1.4	1/4" FEMALE FASTON	10
3	BR	18	CON4	STRIP	SM1.4	3/16" FEMALE FASTON	18
4	YL	18	CON4	STRIP	SM1.2	3/16" FEMALE FASTON	15
5	YL	18	CON4	STRIP	SM1.2	3/16" FEMALE FASTON	15
6	BR	18	R1.0	CON7	STRIP	STRIP	6
7	BR	18	R1.1	CON8	STRIP	STRIP	6
8	BR	16	R1.6	CON6	M1.2	1/4" FEMALE FASTON	12
9	WH	18	CON1	STRIP	M1.2	1/4" FEMALE FASTON	12
10	GN	18	M1.5ND	1/4" FEMALE FASTON	GN	#8 RING	9

ITEM	REF.	QTY	P/N	ROW	DESCRIPTION
1	CON1-8	56244			CONNECTOR, 3 POS
2	M1	115043			MOTOR
3	R1	56432			RELAY, 12VDC
4	SM1	118019			SWITCH, 12VDC (BLU)
5	SM2	118040			SWITCH, MAGNETIC REED
6	SM3	55218			SWITCH, COIL
7	M1	55231			TRANSFORMER, (100/277VAC TO 120V)

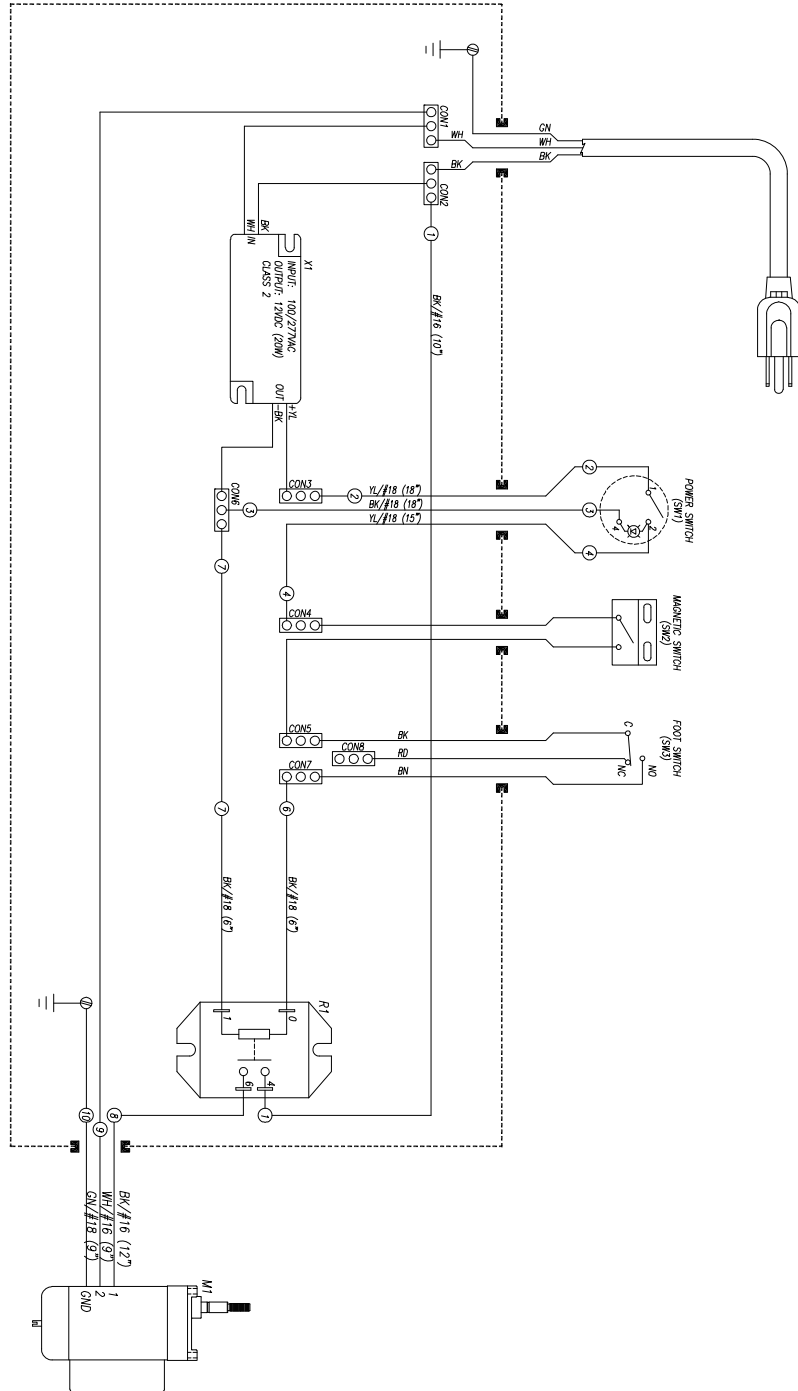

**Important Note** for wiring the foot switch and momentary switch:  
 The motor should not turn on until the foot switch is pressed.  
 If motor turns ON immediately when unit is connected to power, move the BLACK (T0) relay wire from the BROWN foot switch wire connector to the RED foot switch wire connector.



## WARRANTY

Gold Medal Products Co. warrants to the original purchaser each item of its manufacture to be free of defects in workmanship and material under normal use and service. Gold Medal Products Co.'s obligation under this warranty is limited solely to repairing or replacing parts, f.o.b. Cincinnati, Ohio, which in its judgment are defective in workmanship or material and which are returned, freight prepaid, to its Cincinnati, Ohio factory or other designated point. Except for "Perishable Parts" on specific machines, the above warranty applies for a period of two (2) years from the date of original sale to the original purchaser of equipment when recommended operating instructions and maintenance procedures have been followed. These are packed with the machine. Parts warranty is two (2) years, labor is six (6) months.

THIS WARRANTY IS IN LIEU OF ALL OTHER WARRANTIES EXPRESSED OR IMPLIED, AND OF ALL OTHER OBLIGATIONS OR LIABILITIES ON OUR PART, INCLUDING THE IMPLIED WARRANTY OF MERCHANTABILITY. THERE ARE NO WARRANTIES WHICH EXTEND BEYOND THE DESCRIPTION ON THE FACE HEREOF. In no event shall Gold Medal Products Co. be liable for special, incidental or consequential damages. No claim under this warranty will be honored if the equipment covered has been misused, neglected, damaged in transit, or has been tampered with or changed in any way. No claim under this warranty shall be honored in the event that components in the unit at the time of the claim were not supplied or approved by Gold Medal Products Co. This warranty is effective only when electrical items have been properly attached to city utility lines only at proper voltages. This warranty is not transferable without the written consent of Gold Medal Products Co.

The term "Original Purchaser" as used in this warranty shall be deemed to mean that person, firm, association, or corporation who was billed by the GOLD MEDAL PRODUCTS CO., or their authorized distributor for the equipment.

THIS WARRANTY HAS NO EFFECT AND IS VOID UNLESS THE ORIGINAL PURCHASER FIRST CALLS GOLD MEDAL PRODUCTS CO. AT 1-800-543-0862 TO DISCUSS WITH OUR SERVICE REPRESENTATIVE THE EQUIPMENT PROBLEM, AND, IF NECESSARY, FOR INSTRUCTIONS CONCERNING THE REPAIR OR REPLACEMENT OF PARTS.

*NOTE: This equipment is manufactured and sold for commercial use only.*



**GOLD MEDAL® PRODUCTS CO.**

10700 Medallion Drive, Cincinnati, Ohio 45241-4807 USA

[gmpopcorn.com](http://gmpopcorn.com)

Phone: (800) 543-0862      Fax: (800) 542-1496  
(513) 769-7676              (513) 769-8500

© 2022 – The text, descriptions, graphics, layout, and other material in this publication are the exclusive property of Gold Medal Products Co. and shall not be used, copied, reproduced, or published in any fashion, including website display, without its express written consent.