

# Tornado and Deluxe Whirlwind

## Instruction Manual

Model No. 3005SS and 3008SS



Tornado Model 3005SS







Whirlwind Model 3008SS



 **GOLD MEDAL**<sup>®</sup>  
FUNFOOD EQUIPMENT & SUPPLIES



Cincinnati, OH 45241-4807 USA



# SAFETY PRECAUTIONS



	 <b>DANGER</b>
	<p>Machine must be properly grounded to prevent electrical shock to personnel. Failure to do so could result in serious injury, or death.                  DO NOT immerse any part of this equipment in water.                  DO NOT use excessive water when cleaning.                  Keep cord and plug off the ground and away from moisture.                  Always unplug the equipment before cleaning or servicing.                  Make sure all machine switches are in the OFF position before plugging the equipment into the receptacle.</p> <p style="text-align: right; font-size: small;">008_051514</p>

	 <b>DANGER</b>
	<p>Improper installation, adjustment, alteration, service, or maintenance can cause property damage, injury, or death. Any alterations to this equipment will void the warranty and may cause a dangerous condition. NEVER make alterations to this equipment. Read the Installation, Operating, and Maintenance Instructions thoroughly before installing, servicing, or operating this equipment.</p> <p style="text-align: right; font-size: small;">014_051514</p>



	 <b>WARNING</b>
	<p>Floss head rotates at high speeds. Operator MUST keep hands and face clear of the floss head to avoid injury. Operator must wear eye protection. Keep all spectators at a reasonable distance, and use a Floss Bubble for added customer protection.</p> <p style="text-align: right; font-size: small;">015_062714</p>

	 <b>WARNING</b>
	<p>Keep all foreign objects out of floss head. To avoid eye injury, DO NOT fill floss head with sugar while the head is on and rotating.</p> <p style="text-align: right; font-size: small;">016_010914</p>



	 <b>WARNING</b>
	<p>Burn Hazard. DO NOT touch spinner head. Allow to cool before cleaning or servicing. Avoid contact with molten sugar.</p> <p style="text-align: right; font-size: small;">006_092414</p>



	 <b>WARNING</b>
	<p>ALWAYS wear safety glasses when servicing this equipment.</p> <p style="text-align: right; font-size: small;">010_010914</p>

## SAFETY PRECAUTIONS (continued)

	 <b>WARNING</b>
	<p>No user serviceable parts inside. Refer servicing to qualified service personnel.</p> <p style="text-align: right; font-size: small;">011_051514</p>

	 <b>WARNING</b>
	<p>Read and understand operator's manual and all other safety instructions before using this equipment. To order copies of the operator's manual go to <a href="http://gmpopcorn.com">gmpopcorn.com</a> or write to Gold Medal Products Co., 10700 Medallion Drive, Cincinnati, OH 45241 USA 1-(800)-543-0862</p> <p style="text-align: right; font-size: small;">022_060215</p>

	 <b>WARNING</b>
	<p>DO NOT allow direct contact of this equipment by the public when used in food service locations. Only personnel trained and experienced in the equipment operation may operate this equipment. Carefully read all instructions before operation.</p> <p style="text-align: right; font-size: small;">012_010914</p>

	 <b>WARNING</b>
	<p>This machine is NOT to be operated by minors.</p> <p style="text-align: right; font-size: small;">007_010914</p>

**Note:** Improvements are always being made to Gold Medal's equipment. This information may not be the latest available for your purposes. It is critical that you call Gold Medal's Technical Service Department at 1-800-543-0862 for any questions about your machine operations, replacement parts, or any service questions. (Gold Medal Products Co. does not assume any liability for injury due to careless handling and/or reckless operation of this equipment.)

## INSTALLATION INSTRUCTIONS

### INSPECTION OF SHIPMENT

After unpacking, check thoroughly for any damage which may have occurred in transit. Claims should be filed immediately with the transportation company. The warranty does not cover damage that occurs in transit, or damage caused by abuse, or consequential damage due to the operation of this machine, since it is beyond our control (reference warranty in back of manual).

### MANUAL

Read and understand the operator's manual and all other safety instructions before using this equipment. To order copies of the operator's manual go to [gmpopcorn.com](http://gmpopcorn.com) or write to Gold Medal Products Co., 10700 Medallion Drive, Cincinnati, OH 45241 USA 1-(800)-543-0862.

### SETUP

Remove all tape and other packing material.

Remove the shipping support angles which protect the suspension springs during transit. Retain these for future use when you transport the machine.

### LOCATION

Place the floss machine in the Unifloss Stand or on a suitable table or bench. Ventilation around the machine is important to insure long life of the components. Be sure to allow a minimum of six inches around each side and no restrictions from supplies or debris in and around ventilation openings.



Wash the floss pan thoroughly with soap and water. Install the floss pan on the machine with the floss head extending up through the center of the pan. Push down on the bottom of the pan to insure it is seated firmly on the pan supports.

As a last precaution before plugging in the machine, look inside the head assembly and make sure the floss ribbons (heating elements) have not shaken out of the band during transportation. If the ribbons are out of the band, they can be easily pushed back into place with your index finger.

## ELECTRICAL REQUIREMENTS

The following power supply must be provided:



**3005SS and 3008SS:** 120 V~, 2400 W, 60 Hz

	 <b>DANGER</b>
	<p>Machine must be properly grounded to prevent electrical shock to personnel. Failure to do so could result in serious injury, or death. DO NOT immerse any part of this equipment in water. DO NOT use excessive water when cleaning. Keep cord and plug off the ground and away from moisture. Always unplug the equipment before cleaning or servicing. Make sure all machine switches are in the OFF position before plugging the equipment into the receptacle.</p> <p style="text-align: right;">008_051514</p>

A certified electrician must furnish sufficient power for proper machine operation and install any supplied receptacle. We recommend this equipment be on a dedicated and protected circuit. Failure to wire properly will void the warranty and may result in damage to the machine. It is Gold Medal Products Co.'s recommendation that this machine be plugged directly into a wall outlet. The use of extension cords is not recommended due to safety concerns, and may cause sacrificed and/or reduced performance. Make sure cord is located to prevent a trip hazard or unit upset.

## BEFORE YOU PLUG IN MACHINE

1. Make sure all machine switches are in the OFF position before plugging the equipment into the receptacle.
2. Make sure the wall outlet can accept the grounded plugs (where applicable) on the power supply cord.
3. The wall outlet must have the proper polarity. If in doubt, have a competent electrician inspect the outlet and correct if necessary.
4. DO NOT use a grounded to un-grounded receptacle adapter (where applicable).
5. Install the unit in a level position.

	 <b>CAUTION</b>
	<p>If the supply cord is damaged, it must be replaced by Gold Medal Products Co., its service agent or similarly qualified persons in order to avoid a hazard.</p> <p style="text-align: right;">039_080614</p>

## CONTROLS AND THEIR FUNCTIONS

### TORNADO AND DELUXE WHIRLWIND CONTROLS

#### MOTOR SWITCH

DPST switch which serves as a master OFF-ON switch and energizes the cooling fan and spinner head drive motor.

**NOTE:** The drive motor is equipped with an internal centrifugal safety switch which makes contact when the floss spinner head reaches approximately 2050 RPM, thus completing the heat circuit. This mechanism provides a safety circuit for the heating ribbons in the case of a motor malfunction.

#### HEAT SWITCH

Three position DPDT switch: Emergency, Off, Normal

##### Emergency (Red position)

This position applies the fixed transformer to increase the line voltage 35 volts (increase the heat in the spinner head) and provide for faster heating. This position should be used when low supply voltage conditions exist. While this position is ordinarily used for start-up under normal operating conditions, it might also be used in situations where the ribbons or equipment have had extensive use.

##### Off

With the switch in this position, the floss ribbons will not heat.

##### Normal (Blue position)

This position applies the fixed transformer to decrease the line voltage by 35 volts (decrease the heat to the spinner head) and provide a normal operating range.

#### HEAT CONTROL

This is a variable transformer used to provide finer control across the pre-selected range of the heat switch. It increases or decreases the voltage to the spinner head (raising or lowering the heat to the head). On the door panel surrounding the heat knob are red and blue graduated scales from 1 to 9 designed to correspond with the setting of the heat switch. For example, if the heat switch is set to normal (blue), adjustments to the ribbon temperatures using the heat control are made reading the blue scale. The greater the number, the greater the heat.

### X-15R WHIRLWIND CONTROLS

#### MAIN POWER AND MOTOR SWITCH

DPST switch which serves as a master OFF-ON switch and energizes the cooling fan and spinner head drive motor. **NOTE:** The drive motor is equipped with an internal centrifugal safety switch which makes contact when the floss spinner head reaches approximately 2050 RPM, thus completing the heat circuit. This mechanism provides a safety circuit for the heating ribbons in the case of a motor malfunction.

#### HEAT RANGE SWITCH

This is a 4-position tap switch with "A", "B", "C" and "OFF" positions. The "A" position corresponds to the highest heating potential, "B" is an intermediate range, and "C" corresponds to the coolest position.

#### HEAT CONTROL FINE TUNING

This is a rheostat which allows you to make small, incremental adjustments to the spinner head ribbon temperatures. The higher the number, the greater the voltage and temperature.

## MAKING FLOSS



1. Before operating your machine, read this section on how to make floss.
2. Using a damp cloth, moisten the inside of the floss pan. This will cause the floss to adhere to the sides of the pan. The Whirlgrip Floss Stabilizer Model No. 3010 works more effectively to prevent floss from leaving the pan and is offered by Gold Medal at a modest price. See the illustration on page 6 which shows proper installation of the Whirlgrip Floss Stabilizer.
3. After reading this entire section, operate your machine as described in the operating instructions for your machine following this section.
4. Pay attention to the direction of the floss as it is spun out of the head. It should be thrown against and adhere to the sides of the floss pan. Attached to the top plate of the spinner head are two floaters, these give additional air current for floss control. By twisting the leading edge of the floaters down, you get more lift and the floss will go upward. With the leading edge up, the floss will go down. A little practice should give you good control in any climatic condition.
5. To pick up floss: Once you practice awhile, anyone can be an expert at rolling the web of cotton candy onto the cone. First, pick up the cone. If it sticks in the stack of cones, do not pull, but twist it off the stack. Hold an inch or two of the pointed end of the cone between your two fingers and your thumb. With a light flicking action, break the web of floss that is building up in the pan. Usually some floss will stick to the cone. Lift up the cone with the ring of floss attached and, by rotating the cone, wind the floss onto it. Do NOT roll floss onto the cone while it is inside the pan. This will just pack the floss onto the cone, causing you to use more floss to fill the cone, and result in less cones of floss per load of sugar. For additional help, reference Floss Making Procedures section.



If you experience difficulty in getting the floss to stick to the cone, it will be helpful to pass the cone over a damp sponge. One pass over the sponge should cause the floss to stick, allowing easier floss pick-up. Many experienced operators prefer to lift the ring out of the pan and, with a flick of the wrist, turn the ring into a figure eight and whip it around the cone. This leaves giant air pockets and makes it appear that you are serving a larger portion.

### Shut Down Procedure

When completing operation for the day (or any prolonged period), run all the sugar out of the floss head. When empty, turn the heat to highest position for approximately one minute to “clean” the band by baking off remaining sugar. NEVER put water in the floss head.

### Cleaning Instructions

	 <b>DANGER</b>
	<p>Machine must be properly grounded to prevent electrical shock to personnel.  <b>DO NOT immerse in water.</b>                  Always unplug the equipment before cleaning or servicing.</p> <p style="text-align: right; font-size: small;">025_020314</p>

	 <b>WARNING</b>
	<p>Burn Hazard. DO NOT touch spinner head. Allow to cool before cleaning or servicing. Avoid contact with molten sugar.</p> <p style="text-align: right; font-size: small;">006_010914</p>

Unplug the machine and wait for the floss head to cool down to room temperature. Wipe all surfaces with a clean, damp cloth. Make sure all parts are dry before resuming operation.

## SUGAR FOR YOUR COTTON CANDY

Our ready to use FLOSSUGAR is the preferred sugar for your new cotton candy machine, but and 100% pure Cane or Beet Sugar will do just fine. Our FLOSSUGAR gives you good rich colors, and great flavors, too. It is packed in handy half-gallon sealed cartons, with E-Z pour spout for filling your machine. FLOSSUGAR comes in 8 flavors, and you can easily change colors for greatest variety, and best sales.

If you want to “Mix Your Own”—use our FLOSSINE, and please follow our directions. If you want a deeper color, slightly dampen the mixed sugar—use a tablespoon of water per five pounds of sugar—sprinkle water over sugar, and mix well. **DO NOT USE EXCESS COLOR**—too much color will mess up the ribbons on your machine, and could impart a bitter taste to the candy. There is a limit as to how dark you can make cotton candy—that’s because it is 98% air; and we cannot color the air.

Today 99% of the sugar manufactured is “Extra Fine Granulated” which does have some small particles which can slip thru the ribbons without being melted. If this becomes objectionable, you can seek out Medium Coarse, or sanding sugars. The larger crystal size will require a little more heat to melt. Read the label on the bag of sugar—today we see some “Free Flowing” sugar for restaurants, and it contains cornstarch, which will burn onto your ribbons, clogging them rapidly. We have also seen some cheap off-brand “sugar” which is a blend of sugar and dextrose or corn syrup. This product makes very poor cotton candy. Please make sure you get good sugar for your cotton candy machine.

## FLOATER ADJUSTMENT

Form leather floaters as shown. This creates a lifting action to float the floss across the gap to the side of the floss pan.

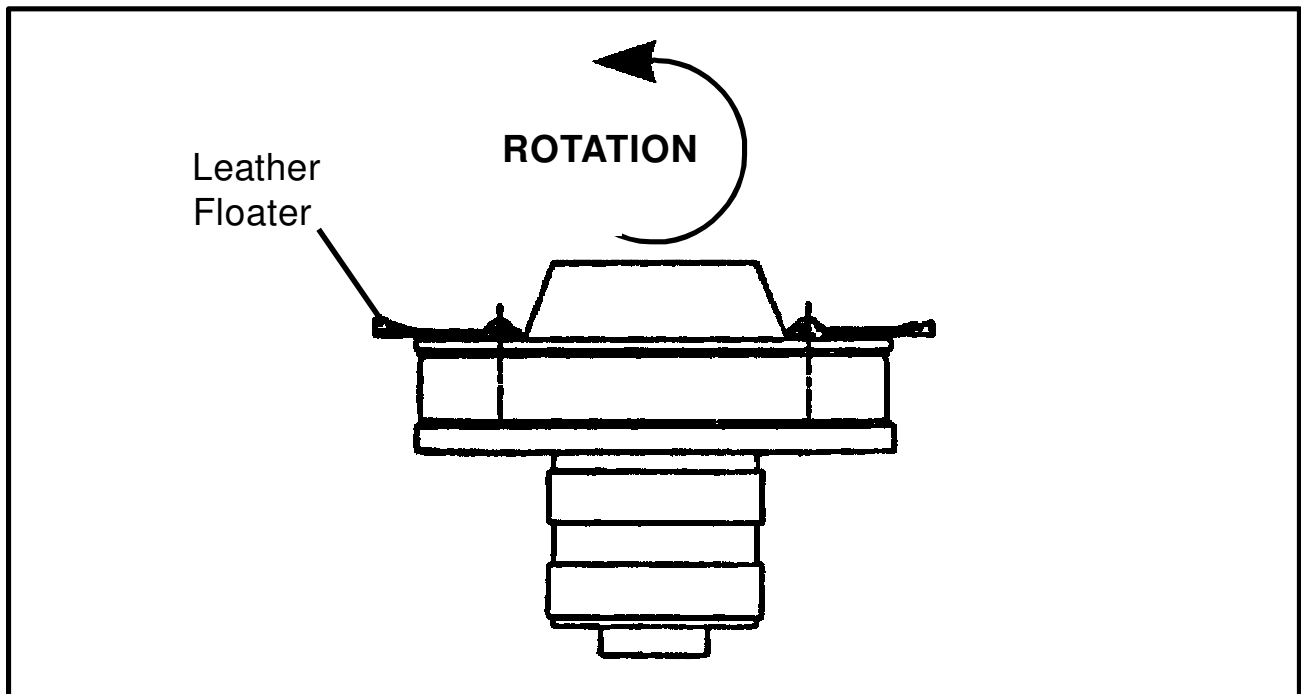

# INSTALLATION OF WHIRL GRIP FLOSS STABILIZER

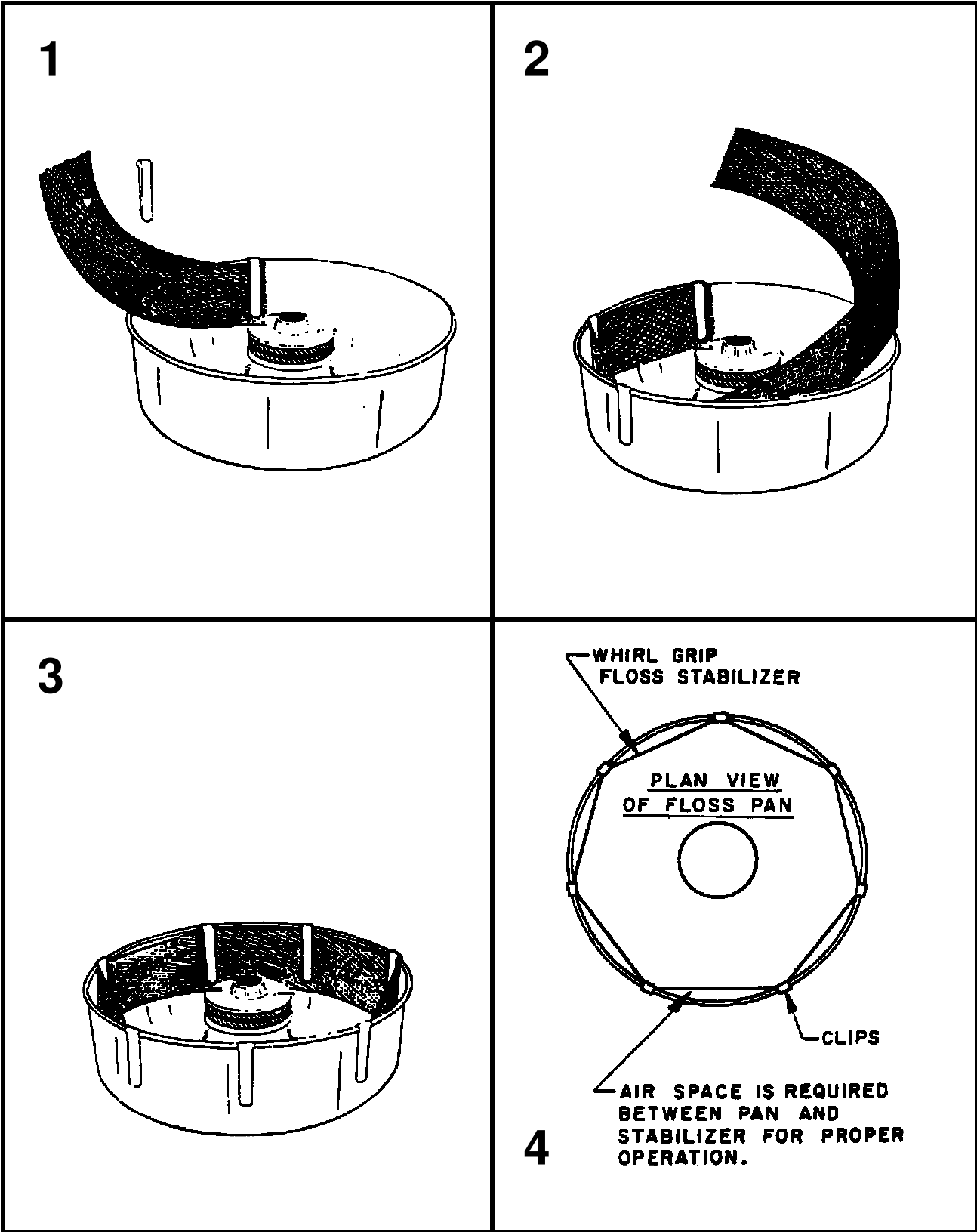

# FLOSS MAKING PROCEDURES

Add Flossugar only while motor is off. Then, manually spin the head to balance. This will eliminate excessive vibration of the head.



When adding sugar, always fill about 90% full.

**DO NOT OVERFILL!**

**CAUTION**

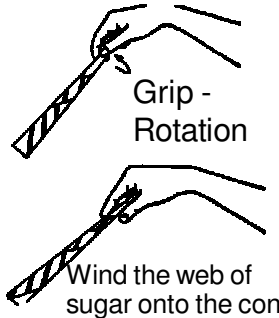

Keep hands away from spinning head!

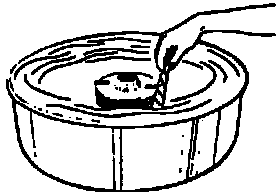
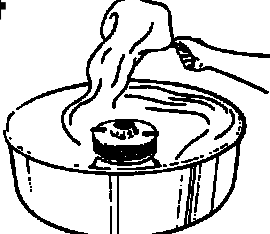
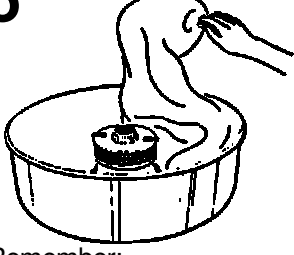
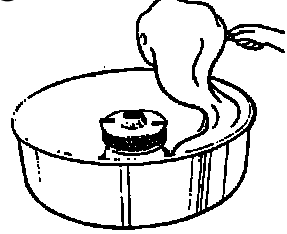
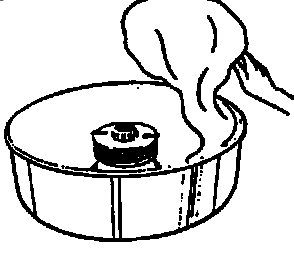
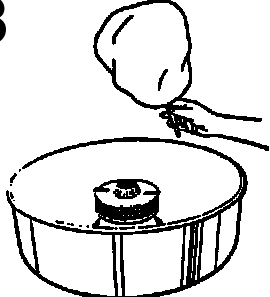
<p><b>1</b></p>  <p>Grip - Rotation Wind the web of sugar onto the cone</p>	<p><b>2</b></p>  <p>Grip cone as shown.</p>
<p><b>3</b></p>  <p>Break into web of floss with the cone.</p>	<p><b>4</b></p>  <p>Lift web of floss from the pan and roll onto the cone.</p>
<p><b>5</b></p>  <p>Remember: Let the machine do the work.</p>	<p><b>6</b></p> 
<p><b>7</b></p> 	<p><b>8</b></p> 

## OPERATING INSTRUCTIONS

### TORNADO AND DELUXE WHIRLWIND

1. Plug in floss machine.
2. Before turning on the motor switch and with the spinner head stationary, fill floss head about 90% full with sugar. Do NOT overfill! Whenever you add sugar to the floss head, always fill it about 90% full. This is necessary to obtain a balanced condition in the floss head or excessive vibration will occur. Never add sugar when motor is running. After adding Flossugar, manually rotate head to balance.
3. Flip Motor Switch to On position.
4. Flip the Heat Switch to Emergency position. This is for a fast warm up. Turn Heat Control up until voltmeter indicator arrow moves into the red start area.
5. The machine should begin to make floss in a matter of a few seconds. After floss is being produced, place Heat Switch in Normal position. Adjust the Heat Control until the voltmeter indicator arrow moves into the green run area.

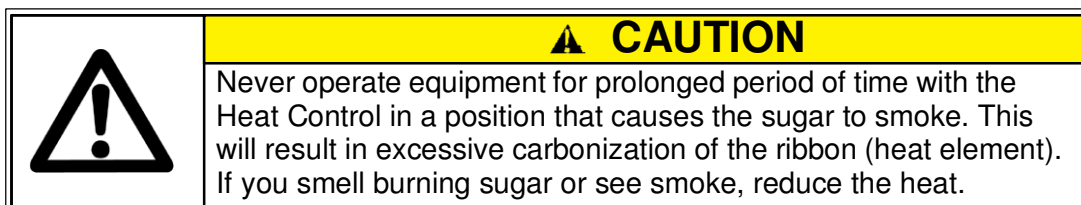

6. Once you find the ideal setting for the Heat Control, you should be able to operate near this position each time.
7. Read the section in this manual on Making Floss before going into full production

### X-15R WHIRLWIND

1. Plug in floss machine.
2. Before turning on the main power and motor switch, and with the spinner head stationary, fill the floss head about 90% full with sugar. Do Not Over Fill! Whenever you add sugar to the floss head, always fill the head about 90% full. This is necessary to obtain a balanced condition in the floss head and eliminate excessive vibration. Never Add Sugar When Motor Is Running. After Adding flossugar manually rotate head to balance.
3. turn the Main Power and Motor Switch to the On position.
4. Turn Heat Range Switch to position "A". Rotate Heat Control Fine Tuning Knob to Maximum position (No. 8). This setting will produce the fastest possible warm up.
5. You should start making floss in a few seconds. When the unit gets up to heat, it will probably start to smoke. Reduce the Heat Control Fine Tuning setting to eliminate the smoke. If you cannot eliminate the smoking in this manner, turn the Heat Range Switch to position "B" and set the Heat Control Fine Tuning to position No. 8 once more. If smoking continues reduce the Heat Control Fine Tuning setting. If necessary, repeat once more with the Heat Range Switch on "C".

**NOTE:** You can fine tune in all three heat range positions.

6. Once you find the ideal Heat Range Switch and Heat Control Fine Tuning positions, you should be able to operate near these positions each time you operate.
7. Read the section on Making Floss before going into full production.

## INDOOR COTTON CANDY SUCCESS TIPS

1. The Unifloss Stand: Choose either the complete Unifloss Stand or the top half only and mount it onto your Snack-N-Treat Bar. The Unifloss Stand plus the Whirl Grip Floss Stabiizer effectively eliminates all indoor objections. In addition, the new Animated Motion Sign Effectively helps merchandise the cotton candy.
2. Candy Floss Is Clean: In fact, it is "poly clean" when you sell cotton candy in poly bags. Cotton candy is never sticky in poly bags. Always make cotton candy on attractive striped cones and put the floss cone and all in the bag. The "Kid Appeal" comes from having a circus style serving on the cone. If you sell cotton candy as a pad, you lose this appeal.
3. Always Use A Printed Cotton Candy Bag: This tends to package the end product more attractively. It only cost a tenth of a cent more to go first class a tenth of a cent is all it cost to make every sale a walking advertisement for building your profits.
4. Use The Automatic Floss Bagger: It's as handy as having three hands. The bag is opened by a stream of air. Hold it open with your free hand and stuff the floss in the bag cone and all.
5. To Sell More Cotton Candy, you should always rotate your colors often. The easiest way is to use Flossugar in the eight exciting color-flavor combinations. Simply pour from the handy half gallon carton into the floss head and presto, you have a new color. Always change colors as the floss head runs out of sugar.
6. Always Display Cotton Candy: Both the Floss Display Board and the Cotton Candy Tree hold enough bagged cotton candy to allow you to produce three complete loads-each a different color. Always display more than one color on the board-it helps to sell more.
7. Point Of Purchase Signs: Paper ppoint of purchase signs are included with each case of cones.
8. In Store Promotions: it always pays to be able to use the public announcement system to help announce to the buying public the location of the cotton candy department. Secondary Display Boards Loaded with product in high traffic areas will also help stimulate sales. Always suggest the multiple sale - carry one-sixth bushel brown kraft bags to help your customers carry out a half dozen at a time.
9. External Promotions: coupons in your ad for free Cotton Candy-or for cents off-always pull in shoppers and build store profits. Free Ad Mats are yours for the asking.

### INSTALLING A UNIFLOSS STAND

There are two halves to a Unifloss Stand. For free-standing installations, use the base and merely set the top half on it as shown in the drawing below. For In Counter installations, place the top section of the Unifloss Stand over a cutout in your counter top. A shelf is required under the counter to set the floss machine on. For counter top cutout size and shelf location, request drawing numbers B-3374 and C-3418 from Gold Medal Products Company.



After the top half of the Unifloss Stand is in position, tilt the floss machine and position the spinner head in the center of the cutout. **NOTE:** Make sure shipping support angles are removed as indicated in the installation section of this manual.

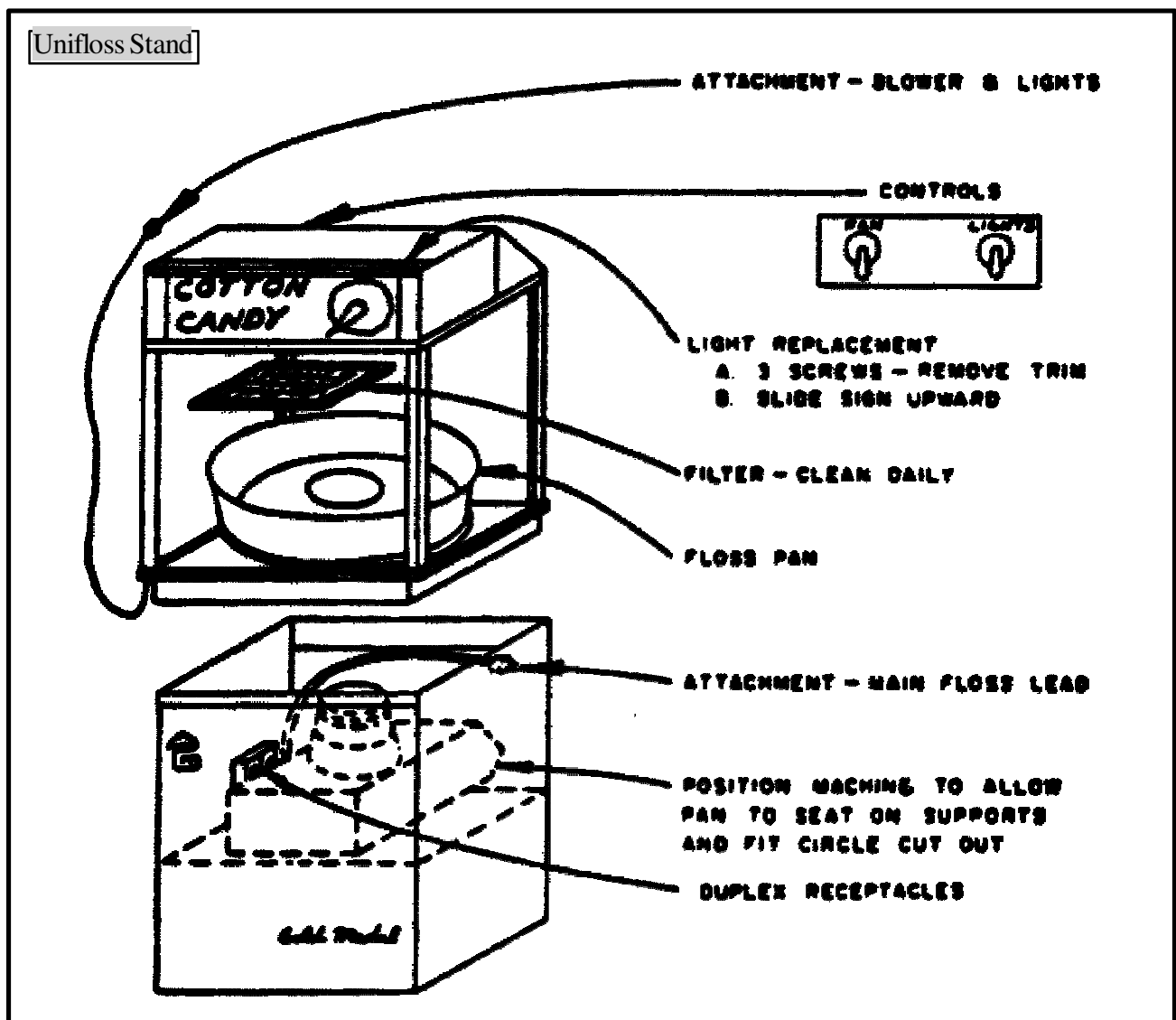

Place the spun aluminum pan over the floss head of the machine. Recenter the machine to provide equal spacing around the pan and cutout.



After connecting the power supply cords, you are ready to make cotton candy. See Operating Instruction in this manual.





# MAINTENANCE INSTRUCTIONS

	 <b>DANGER</b>
	<p>Machine must be properly grounded to prevent electrical shock to personnel. Failure to do so could result in serious injury, or death.                  DO NOT immerse any part of this equipment in water.                  DO NOT use excessive water when cleaning.                  Keep cord and plug off the ground and away from moisture.                  Always unplug the equipment before cleaning or servicing.                  Make sure all machine switches are in the OFF position before plugging the equipment into the receptacle.</p> <p style="text-align: right;">008_051514</p>

	 <b>DANGER</b>
	<p>Improper installation, adjustment, alteration, service, or maintenance can cause property damage, injury, or death. Any alterations to this equipment will void the warranty and may cause a dangerous condition. NEVER make alterations to this equipment. Read the Installation, Operating, and Maintenance Instructions thoroughly before installing, servicing, or operating this equipment.</p> <p style="text-align: right;">014_051514</p>

	 <b>WARNING</b>
	<p>No user serviceable parts inside. Refer servicing to qualified service personnel.</p> <p style="text-align: right;">011_051514</p>

	 <b>CAUTION</b>
	<p>THE FOLLOWING SECTIONS OF THIS MANUAL ARE INTENDED ONLY FOR QUALIFIED SERVICE PERSONNEL WHO ARE FAMILIAR WITH ELECTRICAL EQUIPMENT. THESE ARE NOT INTENDED FOR THE OPERATOR.</p> <p style="text-align: right;">027_010914</p>

## FLOSS BANDS AND RIBBONS

The Gold Medal Floss Bands are made of high strength material with a dielectric coating for insulating of the bands and are designed to give long and trouble-free service. Nevertheless damage will result if subjected to undue pressure from over-tightening of the floss head screws, dropping of the bands, or striking the bands sharply. If a chip or crack appears inside contact areas where the ribbons are positioned, the band must then be replaced since the insulating capacity of the band is lost.



Gold Medal Floss Ribbons (Heat Elements) are made of nickel nikrome wire with ceramic insulation at the terminal point and on the lead wires. They are designed to be as reliable as the Gold Medal Floss Bands, however, ther are certain cautions which must be exercised in the handling of the ribbons. The most common problem with the ribbon is stretching. Once it is stretched it will not fit inside the band properly. The ceramic insulator on the lead wires will break if the wires are bent sharply. Therefore, make all bends gradually when installing the ribbons.

Head gaskets are made of quality gasket material and offered at a cost which will allow equipment owners to replace them when removing and replacing the band.

## REMOVAL OF FLOSS BANDS AND RIBBONS

1. Unplug this unit before servicing!
2. Remove all sugar from the head of the machine before disassembling. If the unit is inoperative, it will be necessary to turn the machine onto its side and shake the sugar out.
3. Remove the (4) spinner cap retainer screws and spinner cap. In some cases, you may find that the sugar has caused the cap and band to stick together. Gentle pressure with the heel of the hand should free the parts for removal.
4. Remove the retaining screws or nuts used to secure the ribbon leads from the terminals. A 1/4-inch nut driver will be helpful here. At this point, both the ribbon leads and bands can be removed from the spinner head.
5. After removing them from the head, run hot water over the band and ribbons to remove the carbonized sugar. In cases where there is an excessive build up of sugar, it may be necessary to soak the band and ribbons in hot water until the sugar dissolves. Bump the band in the palm of your hand to loosen the ribbons for removal.

At this point, you are ready to inspect, clean and/or replace your bands and ribbons. If the ribbon has been removed for cleaning, an additional soaking in hot water should remove the rest of the carbon build up. If the carbon persists in sticking to the ribbons, it must be burned off by inducing electric current through the ribbon. First, turn the ribbon inside out so that the

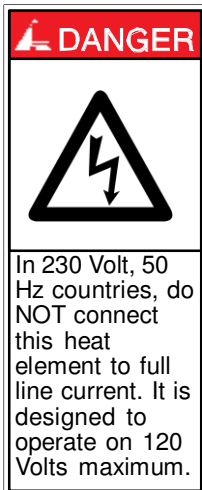

lead wires are pointed outward, and place the ribbon on a non-conductive surface such as a brick or china plate before hook up. Hook up a test cord (an extension cord with clips that can be connected to the ribbon lead wires). Plug the test cord in and let the ribbon glow a cherry red. Do NOT allow the cord to remain plugged in longer than a minute. Unplug and allow to cool for a couple minutes. While it is still unplugged, shake it a couple of times and you should see pieces of carbon fall away. Repeat the process and you will find that almost all of the carbon will burn up and fall away.

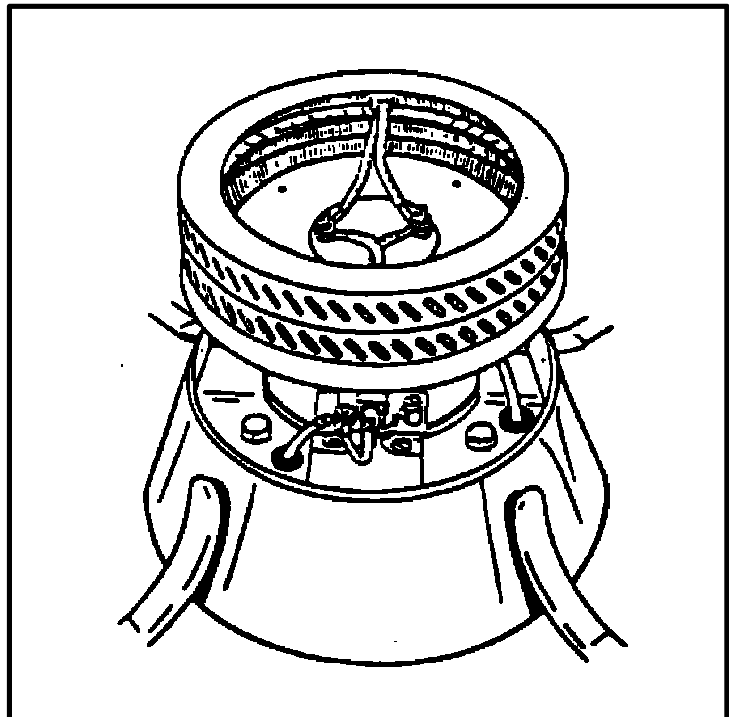

## REPLACEMENT

1. Using a damp cloth remove sugar build up on the spinner head casting and make sure the new gasket sits properly on the casting.
2. Make sure the bands are dry before installing, being sure the band sits properly on the gasket.
3. Install the ribbons in the bands and connect the eyelets of the ribbon lead wires go to the terminal strips, being sure that the lead wires go to separate terminals (One lead wire from the ribbon on one terminal and the other lead wire on the other terminal). Caution must be taken in forming the ribbon leads not to break the ceramic beads and insulators.
4. Make sure the ribbon is securely seated in the band and replace the lead wire retainer screws. When tightening the screws be sure the lead wires do not bend, since this will pull the ribbon away from the band.
5. Install the head gasket, spinner cap, floaters and spinner capretainer screws, but draw down the screws just enough to retain the spinner cap. Rotate the head assembly by hand, just enough to note any out of balance condition in the band and spinner cap. If there is a noticeable wobble in the cap and band, move the spinner cap and band until the head seems to travel in a true circle.

## BRUSHES AND SLIP RINGS

Slip Rings are made of quality bronze and should give long service providing they receive periodic maintenance. Recommended cleaning and inspection time is after every 500 pounds of sugar. Inspect rings for pits, discoloration and excessive wear. Rings should not be flush with the phenolic parts and or worn unevenly. Inspect brushes for proper seating, wear, and free movement. Brushes should not be allowed to wear down smaller than 1/2".

## INSPECTION, CLEANING AND MAINTENANCE

1. Unplug the machine before cleaning and servicing.
2. Place motor and heat switches in off position. Remove the retainer screws and brush cover. Using a damp cloth and blunted instrument (such as a wooden dowel) remove all sugar accumulation. Be sure to remove all sugar from around the motor shaft as any sugar getting into the motor will destroy motor parts.
3. Visually inspect rings and brushes for above mentioned discrepancies. Then correct them as instructed below.
4. If brushes are worn below 1/2" long, they should be replaced. The brush terminal nut may be removed with an 11/32" open end wrench.
5. When brushes are sitting correctly and the rings are in a good non pitted condition, they will be light gray color. when they are pitted, burned or in need of attention, they will be dark black and have a burned appearance. Pull the brushes back from the slip rings but not all the way out of the brush holder. Allow the brush spring to hold the brush in this position. Insert a strip of Emery Cloth against the slip ring. (Emery cloth is available from Gold Medal). While holding the ends of the emery cloth, plug in the machine and turn the motor switch On. By pulling gently on the ends of the emery cloth and moving them slowly up and down, the rings will be sanded. Apply just enough pressure to thoroughly clean surface. Stop the motor, remove dust by blowing on part surfaces be sure to remove all emery dust, as abrasive action may cause problems later. Rings should now be bright in color and have no pits.

Examine the rings closely, as pits will cause an arching which will quickly destroy the brushes and rings. Repeat the sanding process if necessary to insure a good surface for the brushes. If surface is clean and smooth you can then install the brushes back against the rings and replace the inspection cover. The equipment is ready for operation. Let the motor run about five minutes before turning on power to the head. This will build up a thin layer of carbon on the rings and reduce the possibility of arcing while the brushes are wearing in.

6. If rings are worn excessively or have pits tht sanding will not remove, they should be re placed. The replacement of slip rings is considered more involved than normal field maintenance. To be done correctly, you should have machine shop facilities. Head assemblies may be returned to Gold Medal to have this maintenance performed. We furnish a rebuilt head assembly if you do not have the time to send in the one from your machine. For open account customers, we will ship the rebuilt head on a Memo basis for full list price. When your head asembly is rebuilt, we will credit off the unit sent, and bill you and we keep yours. For customers who do not have credit established, send us the full price of the head assembly we will send you a rebuilt unit at once. When repairs are made on your head assembly, we will charge them to your account and send you a check for your refund promptly.

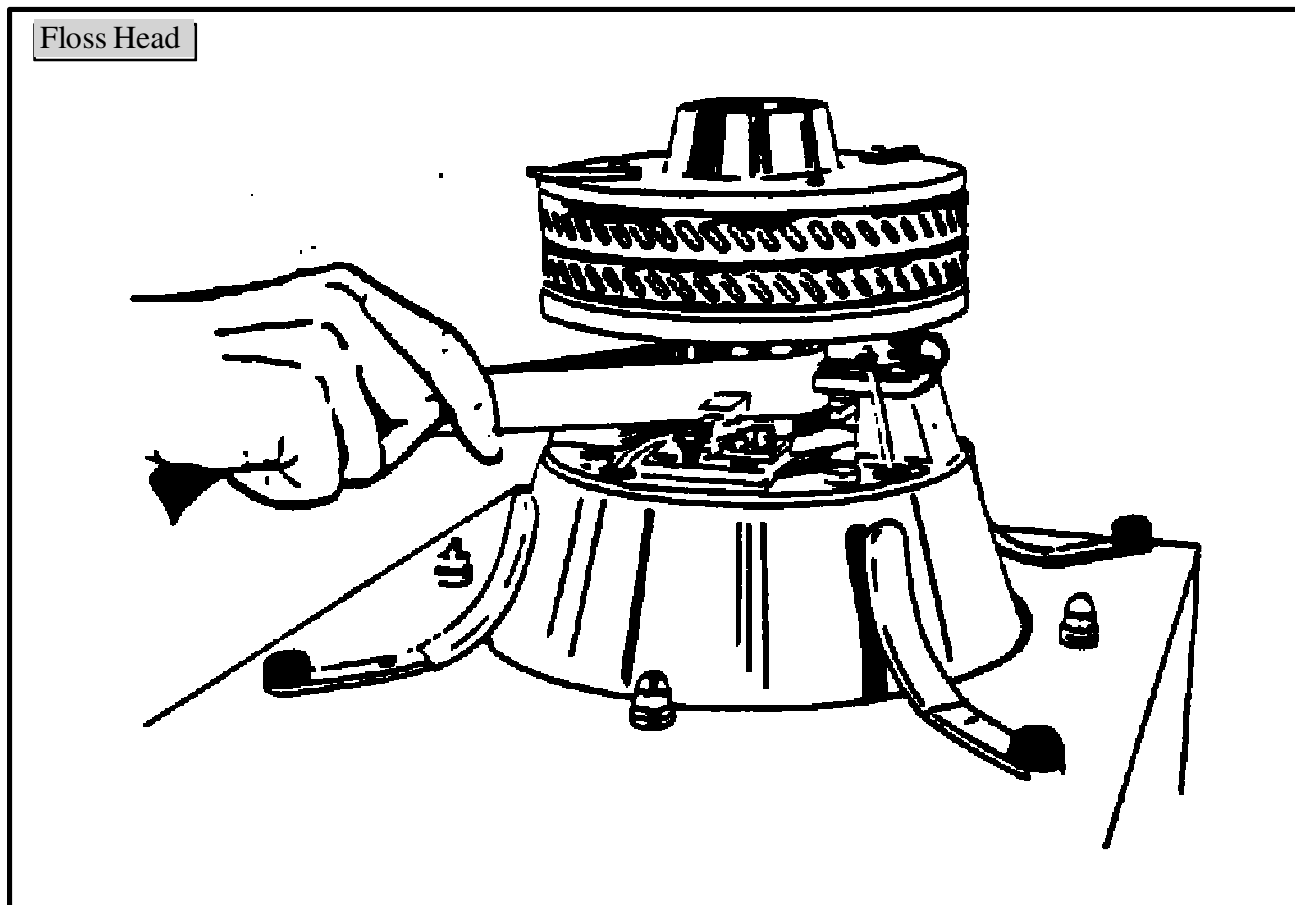

## REPLACING SLIP RINGS

1. Unplug before servicing.
2. Remove band and ribbons as outlined in Maintenance - Floss Bands and Ribbons.
3. Remove the head assembly by first taking out the set screw between slip rings with a  $\frac{3}{32}$ " allen wrench. Remove the nylon nut and terminal guard. Using a  $\frac{1}{8}$ " allen wrench, turn the jack screw in the center of the head. This will push the head off of the motor shaft. Do NOT use hammer on the head, as you run the risk of breaking the head, we suggest you stop. Package the machine and send it to us for repair; it is cheaper than buying a new head assembly.
4. Remove the four nuts from the slip ring studs and it will be possible to pull the ring and phenolic parts from the head casting.
5. Remove phenolic parts and unscrew the slip ring studs from the slip rings. These must be replaced correctly in order to get the assembly together again.
6. Thread one slip ring stud into one slip ring, allowing approximately one inch to protrude through. This will be the top ring. Thread the other slip ring stud through the other ring, allowing it to protrude approximately two inches. This will be the bottom ring. Now re-assemble the phenolic parts and rings on the head casting in the order that they were disassembled. Replace the nuts on the studs and tighten.
7. Attempt to replace the retaining set screw. If it meets with resistance, the parts are not in exactly the same position as they were originally. This necessitates the drilling and tapping of a new hole for the set screw (Tap Size No. 10-24 Thread).
8. The entire head assembly must now be chucked in a lathe and a cut taken off the slip rings. They should be taken down approximately .010 to .015 thousandths of an inch or until they run true and there are no pit holes visible. **NOTE:** We suggest a  $\frac{3}{4}$ -inch diameter rod chucked in a lathe chuck and turned to 0.625 in. diameter. Then clamp the head to the pin with the set screw and turn the slip rings.

## TROUBLESHOOTING

Gold Medal Floss Equipment requires very little maintenance, most of which can be accomplished with a few simple hand tools and testing equipment.

### TOOLS

Common screwdriver - medium size

Phillips screwdriver - medium size

$\frac{7}{16}$ " Nut driver

$\frac{1}{4}$ " Nut driver

$\frac{3}{32}$ " &  $\frac{7}{64}$ " Allen wrench

Strips of 180-J Emery Cloth -1" by approximately 20" (Available from Gold Medal)

### TEST EQUIPMENT

Circuit testing device (one of any of the following)

Neon Light tester

Voltmeter with lead wires

### IF EQUIPMENT IS DEAD ELECTRICALLY

Check power supply, is the machine plugged in and the switch turned on? Check electric outlet and protective devices-fuse. Circuit breaker, etc. Will another appliance operate from the same outlet? Check the outlet with a circuit tester.

If you are sure of current at your wall outlet, then the problem is probably in the equipment.

After checking over the mentioned items and the equipment is still inoperative, the trouble is in one of the components. It is best to have them checked by a competent electrician or returned to Gold Medal for repair. However, here is a simple check you can perform to determine which component is at fault.

Disconnect motor lead wires and induce current directly into the motor. If the motor runs, you have a faulty motor switch. If the motor fails to run, it is the faulty part. When removing wires be sure to remember which terminals they came from and that you return them to the correct terminals.

### IF MOTOR RUNS, BUT EQUIPMENT FAILS TO PRODUCE FLOSS

On equipment without a voltmeter, a circuit tester can be used to determine if you have current to the brushes. Remove the brushes. With the equipment plugged in and switches on, touch a lead wire from the circuit tester to the inside of the brush holder. If the tester shows current to the brushes, your problem is in the head assembly.

1. Check the floss head to make sure there is sugar present.
2. Check the brushes-are they sitting flush against the slip rings and bear no evidence of arcing?
3. Check connections on the brush lead wires.
4. Check ribbons for excessive carbonization-the ribbons may be completely clogged with carbon, disassemble the band and ribbons as described previously in this manual.

If these procedures are followed and the problems still have not been located, it is necessary to check the control components; i.e. heat and motor switches, heat controls, and fixed transformers, if applicable. The servicing by an electrician is encouraged for this procedure. However, if you have a continuity tester or voltmeter with lead wires, it may be possible to find the faulty component by using the process of elimination. Use the wiring diagrams provided for all necessary wire tracing.

5. With the equipment plugged in and switches in the normal operating positions, check for current flow into or out of each component. If there is evidence that a component is defective. It may be helpful to look for evidence of arcing or burning. Frequently, a fault component will bear evidence of excessive heat.

### LOW PRODUCTION

1. A primary reason for low production is excessive carbon on the ribbons. Follow the instructions for removal and cleaning of bands and ribbons.
2. Check heat control for correct setting. Metered equipment has marked graduations on the voltmeter which indicate points where the equipment should operate most efficiently.
3. Check the line voltage. A primary reason for low production and poor working of equipment is low line voltage. Have an electrician check the line voltage and add new lines if there is not enough current for the requirement listed on the equipment name plate. **NOTE:** The Tornado and Deluxe Whirlwind equipment have the ability to increase the line voltage approximately 20%.
4. Check the ribbons. One burned out or shorted ribbon will cut production in half.
5. Foreign objects in the head assembly may short a ribbon or create an out of balance condition.

### EXCESSIVE SMOKE

1. Check heat control setting. After warm up, equipment should make good floss at a reduced setting. **NOTE:** Never run the machine with the heat so high as to see smoke or smell sugar burning.
2. Check the mixture of the product being used in the head. Use nothing with a cornstarch base-do not over use Flossine-be sure sugar is dry and free of lumps.
3. Check the band and ribbons for excessive carbon build up and remove it as previously stated in this manual.

### EXCESSIVE VIBRATION

1. If the equipment is new, check for shipping bolt or packing material accidentally left in the machine.
2. Whenever you add sugar to the floss head, you should always fill it completely. This is necessary to obtain a balanced condition in the head and eliminate vibration. Do NOT add sugar with motor running!
3. Check for stretched or uneven suspension springs.
4. Check for foreign objects or lumps of sugar in the head assembly. Run the sugar completely out for this.
5. Loosen the spinner cap retainer screws. Tighten and balance the head as previously described.

## ORDERING SPARE PARTS

1. Identify the needed part by checking it against the photos, illustrations, and/or parts list.
2. Use only approved replacement parts when servicing this unit.
3. When ordering, please include part number, part name, and quantity needed.
4. Please include your model number, serial number, and date of manufacture (located on the machine nameplate/data plate) with your order.
5. Address all parts orders to:

Parts Department  
Gold Medal Products Co.  
10700 Medallion Drive  
Cincinnati, Ohio 45241-4807

Or, place orders by phone or online:

Phone: (800) 543-0862  
(513) 769-7676  
Fax: (800) 542-1496  
(513) 769-8500  
E-mail: [info@gmpopcorn.com](mailto:info@gmpopcorn.com)  
Web Page: [gmpopcorn.com](http://gmpopcorn.com)

# CABINET ASSEMBLY

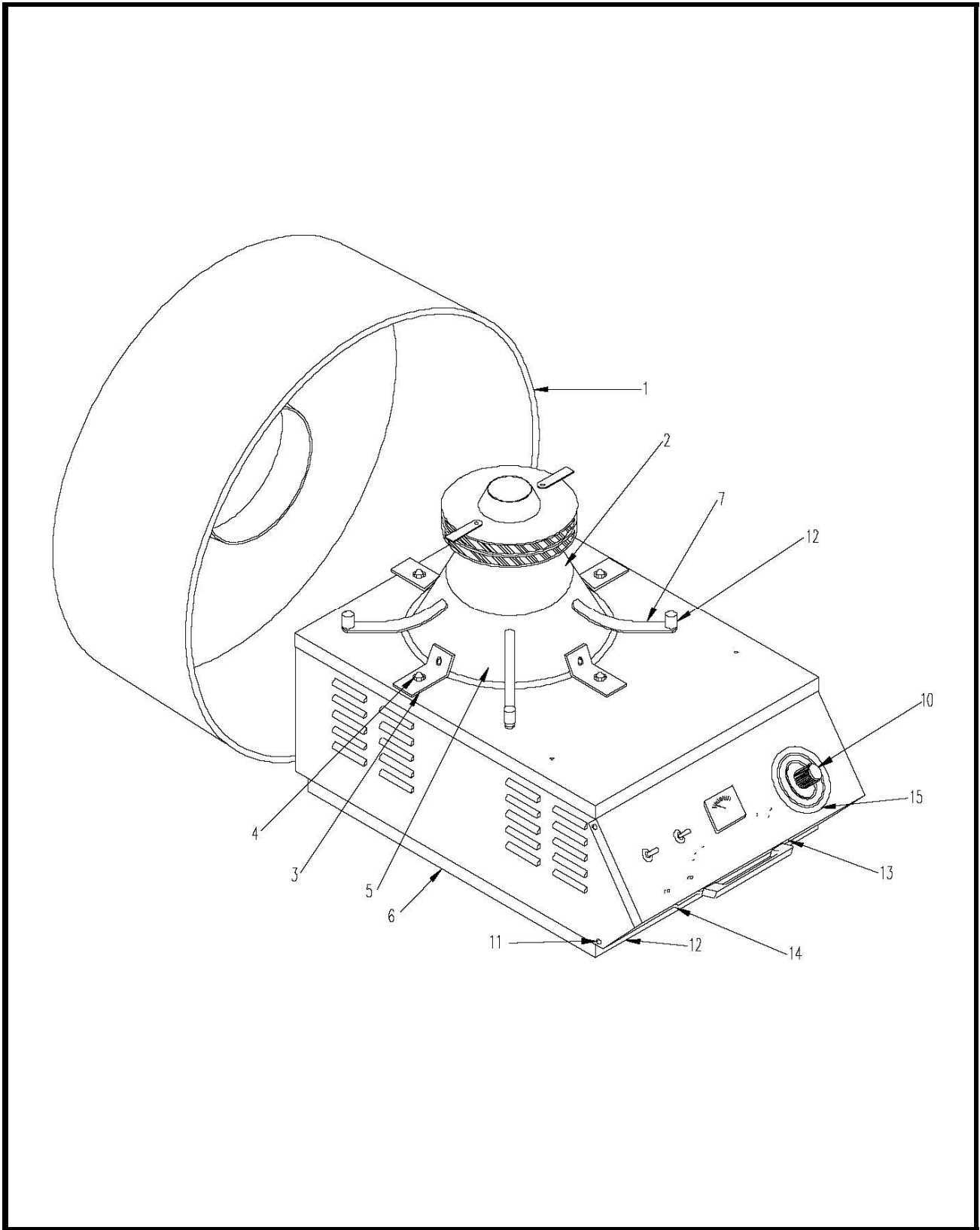

## PARTS LIST – CABINET ASSEMBLY

Item No.	Tornado Part No.	Deluxe Whirlwind Part No.	X-15R Part No.	Description
1	42040	42040	42040	Floss Pan
2	42008	42008	42008	Brush Cover
3	48019	48019	48019	Shipping Support Angle
	48020	48020	48020	Warning Tag
4	20006	20006	20006	Suspension Spring
5	20029	20029	20029	Main Motor 120V
	42063	42063	42063	Sugar Seal (MAC Motor)
	42046	42046	42046	Sugar Seal (GE Motor)
	42107	42107	42107	Sugar Seal (Baldor Motor)
	20051	20051	20051	$\frac{3}{8}$ " Hex Motor Mount Bolt
6	42310	42310	42310	Bottom Cover
7	42049	42049	42049	Pan Support
9	42065	42065	n/a	$\frac{3}{16}$ " Dia. Plastic Plug
10	42022	42022	48027	Heat Control Knob
11	42042	42042	42042	#8-32 Door Mount Screw
12	47155	47155	47155	$\frac{3}{4}$ " High Rubber Feet
13	43148	43148	43148	Stainless Steel Door Assembly
14	n/a	47364	47364	15 Amp Circuit Breaker

## PARTS NOT SHOWN

42048	42048	42048	Shipping Carton - Unit
42052	42052	42052	Shipping Carton - Pan
47211	47211	47211	Power Supply Receptacle
47377	47377	47377	Power Supply Cover Plate

Tornado Unit

3005SS

Deluxe Whirlwind Unit

3008SS

### X-15R WHIRLWIND ASSEMBLY

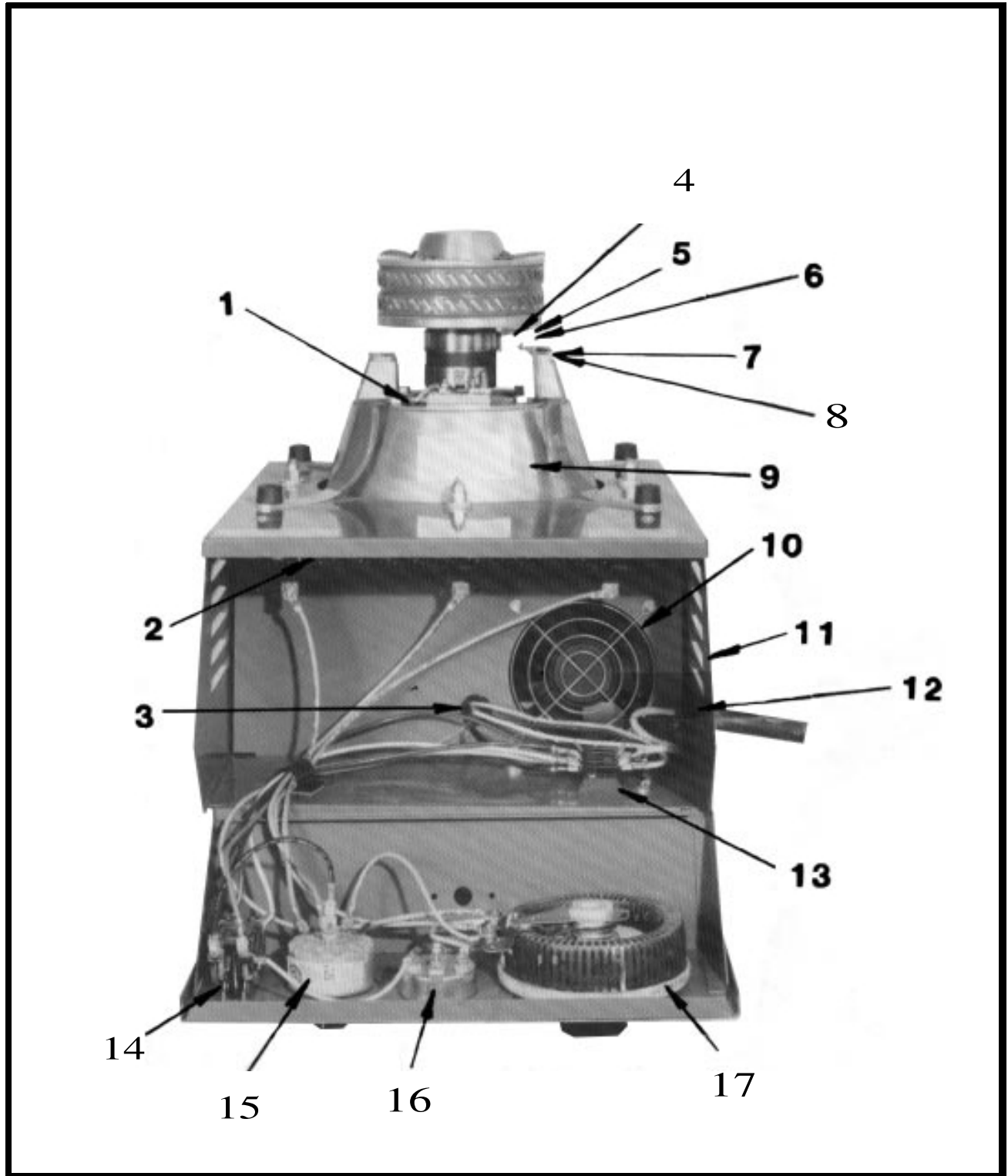

## PARTS LIST – X-15R WHIRLWIND

Item No.	Part No.	Description
1	47236	Snap Bushing #SB-500-6
2	48031	Resister
3	45396	Snap Bushing
4	42320	Brush Assembly with Brush
BRUSH ASSEMBLY PARTS LISTING		
	20032	Brush Holder
	20034	Carbon Brush
5	20033	Brush Tension Spring
6	20052	Brush Tension Spring Screw
7	42035	Brush Pad
8	48017	Brush Holder Insulator
9	42034	Motor Mount Casting
10	47200	Finger Guard
	48018	Exhaust Blower, 120V
	47199	Blower Plug and Cord
11	43012	Stainless Steel Case Assembly
12	47026	Strain Relief #SR-9P-2
	47603	Lead-In Cord, 120V
13	42006	Terminal Block
14	43141	Motor Switch
15	48033	Heat Range Tap Switch
	48028	Tap Switch Bar Knob
16	48010	Voltmeter, 120V
17	48029	Rheostat, 120V
	46081	30 Amp Relay Switch

### 3005SS TORNADO & 3008SS DELUXE WHIRLWIND

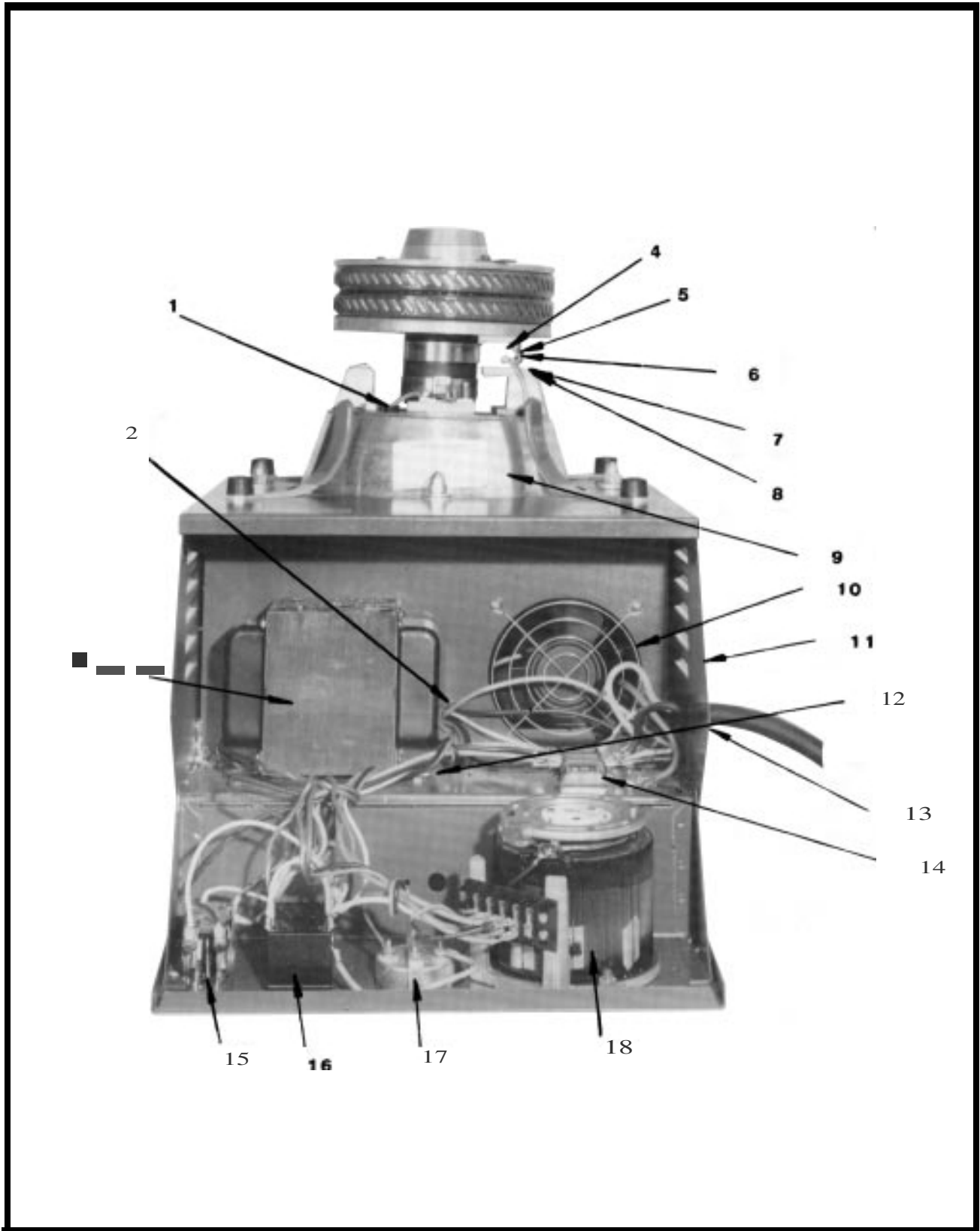

## PARTS LIST – TORNADO and DELUXE WHIRLWIND

Item No.	Tornado Part No.	Deluxe Whirlwind Part No.	Description
1	47236	47236	Snap Bushing #SB-500-6
2	45396	45396	Snap Bushing #SB-875-10
3	43006	43006	Transformer, 120V
4	42320	42320	Brush Assembly with Brush
BRUSH ASSEMBLY PARTS LISTING			
	20032	20032	Brush Holder
	20034	20034	Carbon Brush
5	20033	20033	Brush Tension Spring
6	20052	20052	Brush Tension Spring Screw
7	42035	42035	Brush Pad
8	48017	48017	Brush Holder Insulator
9	42034	42034	Motor Mount Casting
10	47200	47200	Finger Gaurd
	48018	48018	Exhaust Blower, 120V
	47199	47199	Blower Plug and Cord
11	43019	n/a	Blue Case Assembly
	n/a	42001	Red Case Assembly
	43012	43012	Stainless Steel Case Assembly
12	42069	42069	Transformer Support Bracket
13	47603	47603	Lead-In Cord, 120V
	47026	47026	Strain Relief #SR-9P-2
14	42006	42006	Terminal Block
15	43141	43141	Motor Switch
16	43142	43142	Heat Switch
17	43009	42019	Voltmeter
18	42020	42020	Heat Control
	n/a	55219	Switch, Relay 120V

### WHIRLWIND FLOSS HEAD ASSEMBLY

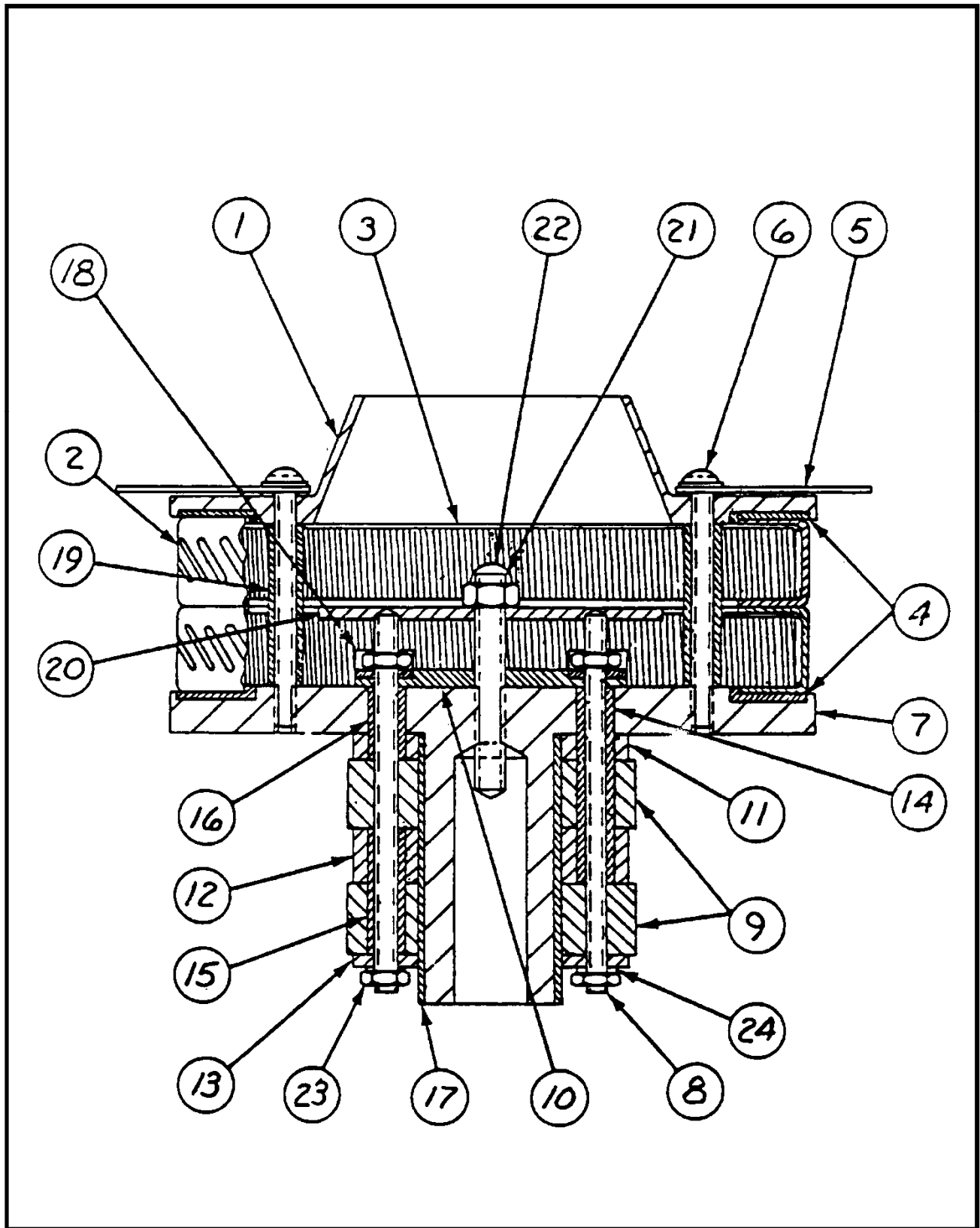

## PARTS LIST - WHIRLWIND LOW PROFILE FLOSS HEAD

Item No.	Part No.	Description
1	42062	Spinner Cap
2	42213	Floss Band, 5" Double
3	42327	5" Ribbon Assembly
4	42216	Phenolic Band Insulator
5	20010	Leather Floaters
6	42041	Head Screw, #10-24 x 2"
7	42053	Spinner Head Casting
8	42032	Slip Ring Stud, 3½" Long
9	20020	Slip Ring, 1¼" ID, 2½" OD
10	42304	Phenolic Terminal Insulator
11	42025	Top Phenolic Washer
12	42026	Center Phenolic Washer
13	20054	Bottom Phenolic Washer
14	42037	Stud Insulator Phenolic, 1¾"
15	42029	Stud Insulator Phenolic, 1 <sup>3</sup> / <sub>32</sub> "
16	42030	Stud Insulator Phenolic, <sup>5</sup> / <sub>8</sub> "
17	42028	Insulator Sleeve
18	42305	Terminal Assembly
19	42308	Stud Insulator Phenolic
20	42303	Terminal Guard Phenolic
21	42311	Set Screw, 1/4-20
22	48041	Acorn Nut 1/4-20 Nylon
23	42301	Hex Nut #10-32 Brass
24	42215	Washer #10 External Tooth

### COMPONENT PARTS NOT SHOWN ON DRAWING

74143	Hex Nut #10-32 Zinc
42325	Spinner Head Complete Assembly
42318	Spinner Head Bottom Assembly
42200	Complete Set of Phenolic Parts
20008	Band Replacement Kit

The following part is for use with the X-15R to make it compatible with X-15R Export Model.

48039	X-15R Conversion Kit 220V
-------	---------------------------

# TORNADO FLOSS HEAD ASSEMBLY

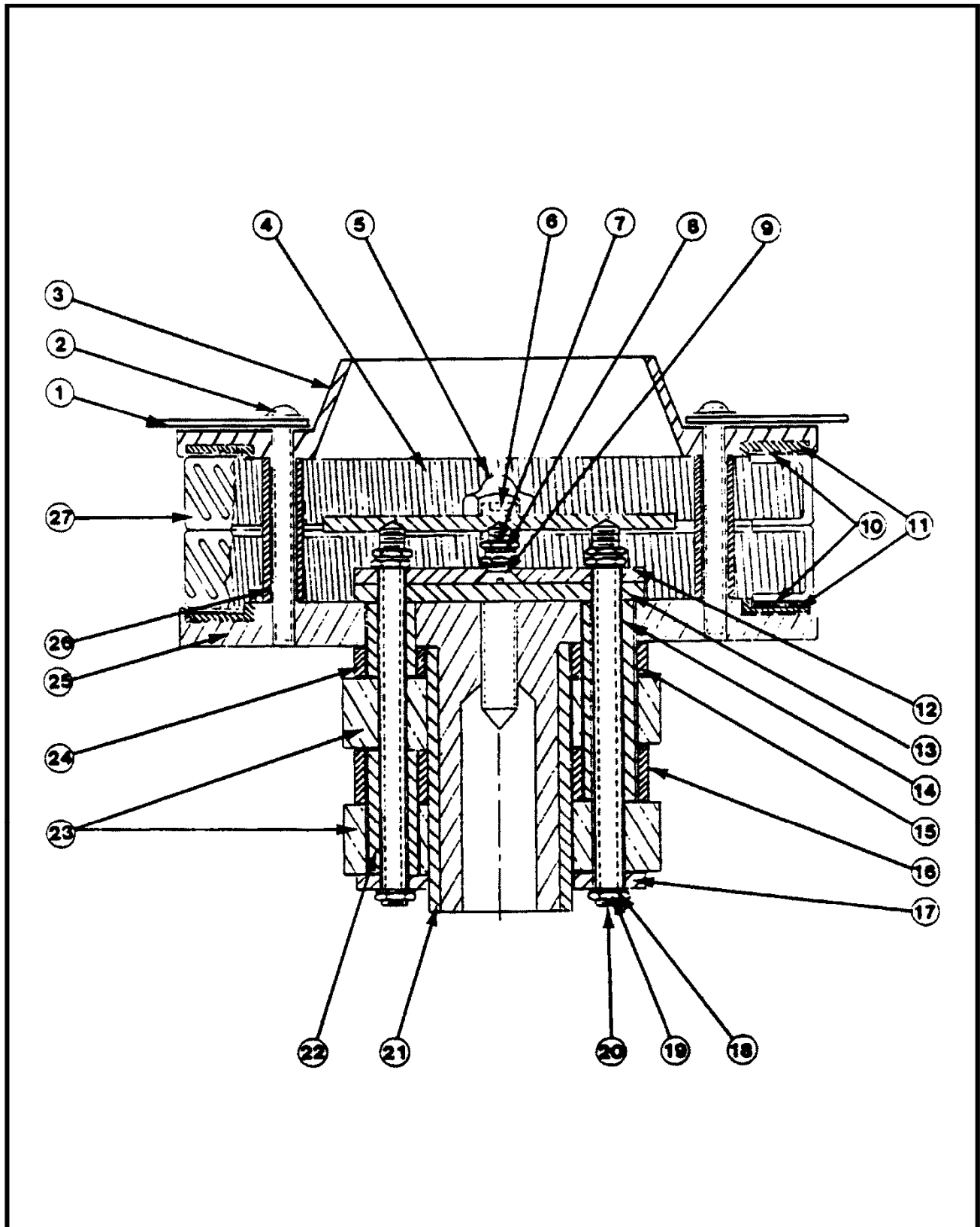

## PARTS LIST - TORNADO LOW PROFILE FLOSS HEAD

Item No.	Part No.	Description
1	20010	Leather Floaters
2	20050	Screw #10-24 x 2¼"
3	43014	Spinner Cap
4	43028	7" Ribbon Assembly
5	48041	Acorn Nut 1/4-20, Nylon
6	42311	Set Screw, 1/4-20 x 2"
7	42303	Phenolic Terminal Guard
8	74143	Hex Nut #10-32
9		Screw #10-32 x ½"
11	42217	Phenolic Band Insulator
12		Top Terminal Insulator
13		Bottom Terminal Insulator
14	42037	Stud Insulator Phenolic
15	42025	Top Phenolic Washer
16	42026	Center Phenolic Washer
17	20054	Bottom Phenolic Washer
18	42215	Washer #10 External Tooth
19	74143	Hex Nut #10-32
20	42032	Head Stud Brass 3½" LG
21	42028	Insulator Sleeve
22	42029	Stud Insulator Phenolic
23	20020	Slip Ring
24	42030	Stud Insulator Phenolic
25	43015	Head Casting
26	42308	Stud Insulator Phenolic
27	42214	7" Double Floss Band
28		Terminal Jumper Assembly

### AVAILABLE PARTS NOT SHOWN

42070	10-24 x ½" Cup Point Set Screw
43026	Spinnerhead Complete Assembly Ready to Use
43008	Spinnerhead Bottom Assembly Ready to Use
42200	Complete Set, Phenolic Parts for Bottom

# Wiring Diagram - Model 3005SS

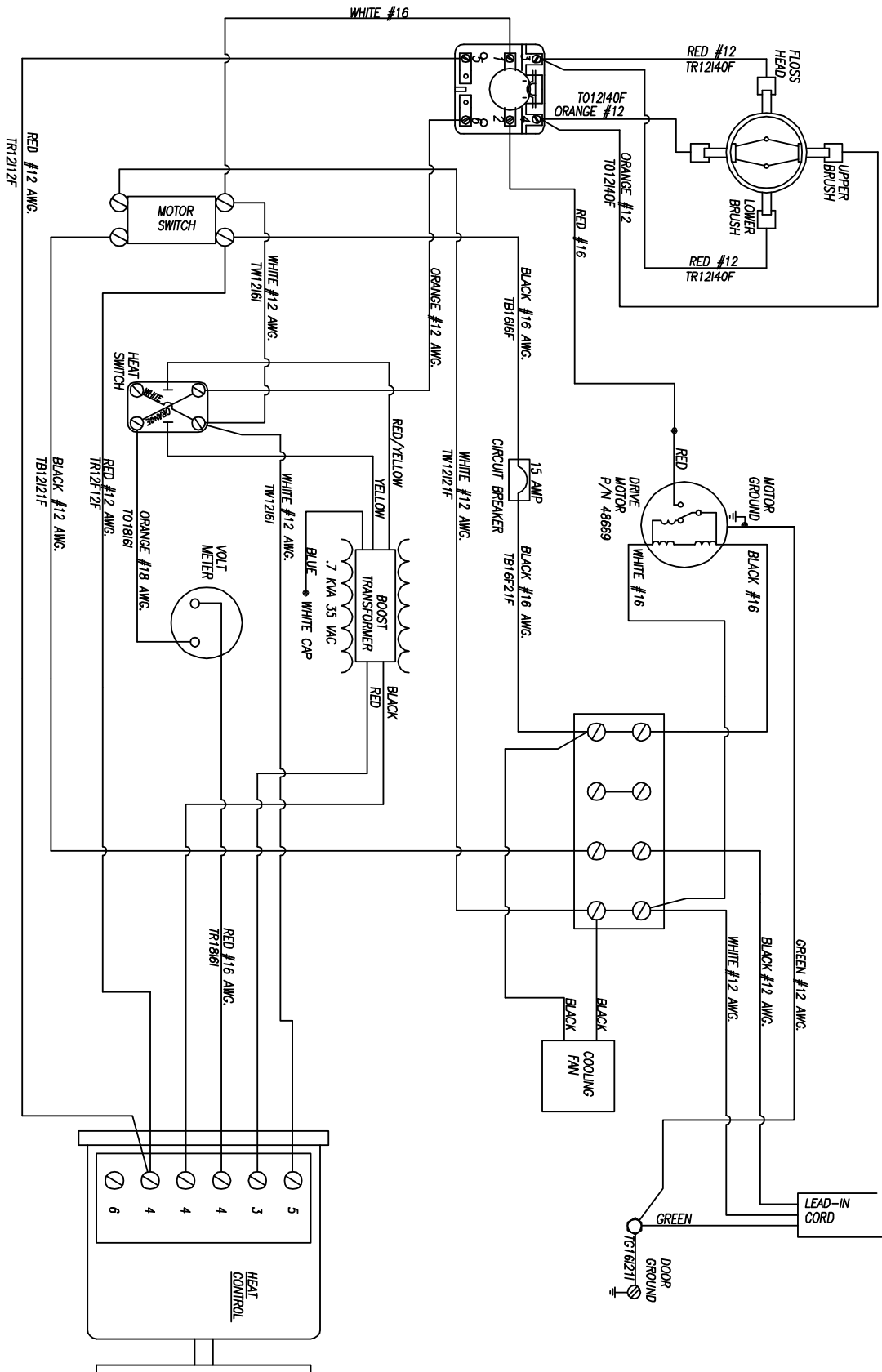

# Wiring Diagram - Model 3008SS

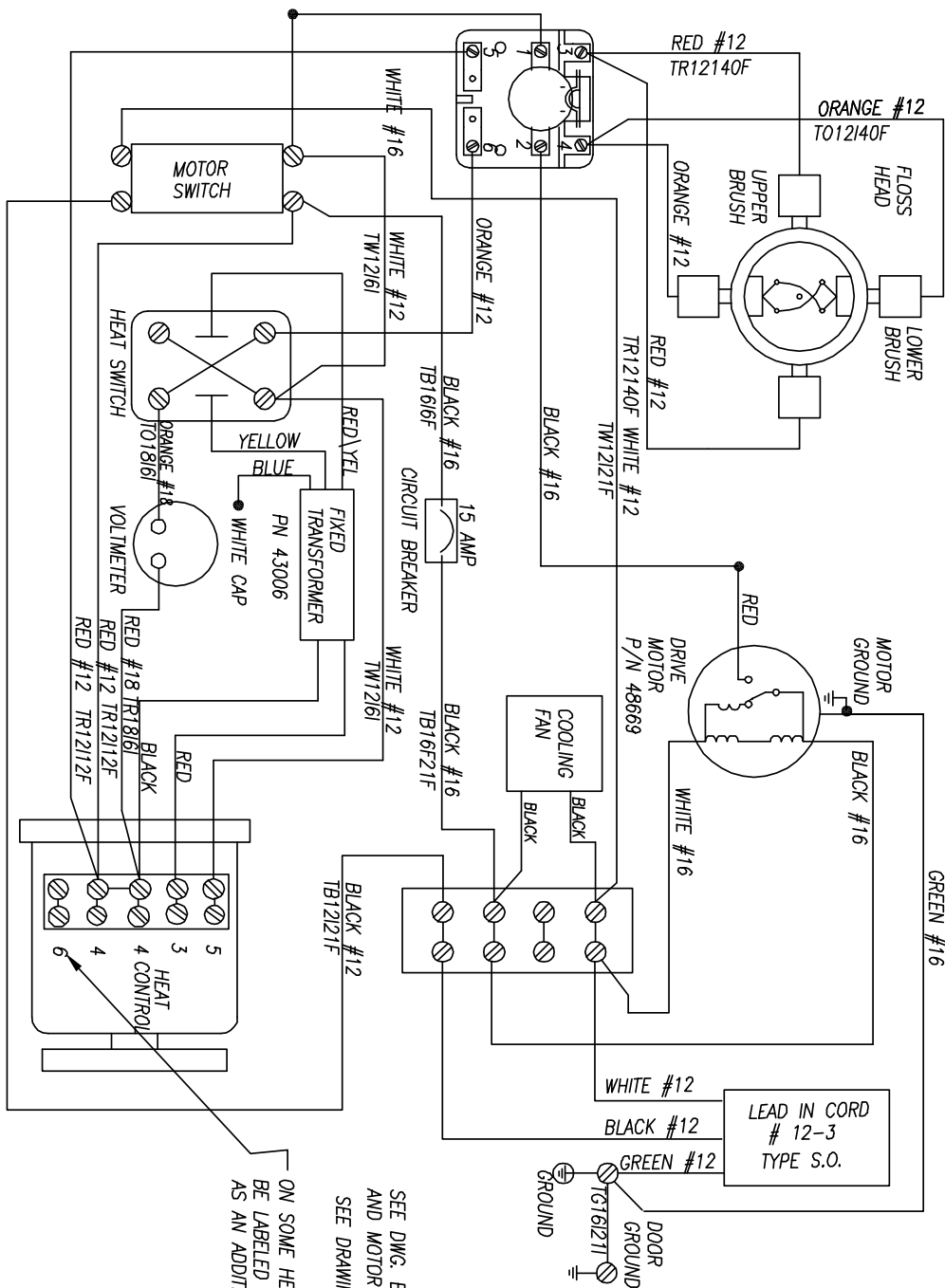

NOTE:  
 AND LABELED WITH AT LEAST 1/32" THICK THERMOPLASTIC RATED 90°C OR 105°C, UNLESS OTHERWISE SPECIFIED.

SEE DWG. B-5660 FOR WIRING W/OUT RELAY AND MOTOR SWITCHES USED.  
 SEE DRAWING 14768 FOR 20029 MOTOR

ON SOME HEAT CONTROLS THIS TERMINAL MAY BE LABELED "4". THIS CAN THEN BE USED AS AN ADDITIONAL 4 TERMINAL.

# WARRANTY

Gold Medal Products Co. warrants to the original purchaser each item of its manufacture to be free of defects in workmanship and material under normal use and service. Gold Medal Products Co.'s obligation under this warranty is limited solely to repairing or replacing parts, f.o.b. Cincinnati, Ohio, which in its judgment are defective in workmanship or material and which are returned, freight prepaid, to its Cincinnati, Ohio factory or other designated point. Except for "Perishable Parts" on specific machines, the above warranty applies for a period of two (2) years from the date of original sale to the original purchaser of equipment when recommended operating instructions and maintenance procedures have been followed. These are packed with the machine. Parts warranty is two (2) years, labor is six (6) months.

THIS WARRANTY IS IN LIEU OF ALL OTHER WARRANTIES EXPRESSED OR IMPLIED, AND OF ALL OTHER OBLIGATIONS OR LIABILITIES ON OUR PART, INCLUDING THE IMPLIED WARRANTY OF MERCHANTABILITY. THERE ARE NO WARRANTIES WHICH EXTEND BEYOND THE DESCRIPTION ON THE FACE HEREOF. In no event shall Gold Medal Products Co. be liable for special, incidental or consequential damages. No claim under this warranty will be honored if the equipment covered has been misused, neglected, damaged in transit, or has been tampered with or changed in any way. No claim under this warranty shall be honored in the event that components in the unit at the time of the claim were not supplied or approved by Gold Medal Products Co. This warranty is effective only when electrical items have been properly attached to city utility lines only at proper voltages. This warranty is not transferable without the written consent of Gold Medal Products Co.

The term "Original Purchaser" as used in this warranty shall be deemed to mean that person, firm, association, or corporation who was billed by the GOLD MEDAL PRODUCTS CO., or their authorized distributor for the equipment.

THIS WARRANTY HAS NO EFFECT AND IS VOID UNLESS THE ORIGINAL PURCHASER FIRST CALLS GOLD MEDAL PRODUCTS CO. AT 1-800-543-0862 TO DISCUSS WITH OUR SERVICE REPRESENTATIVE THE EQUIPMENT PROBLEM, AND, IF NECESSARY, FOR INSTRUCTIONS CONCERNING THE REPAIR OR REPLACEMENT OF PARTS.

*NOTE: This equipment is manufactured and sold for commercial use only.*



**GOLD MEDAL<sup>®</sup> PRODUCTS CO.**

10700 Medallion Drive, Cincinnati, Ohio 45241-4807 USA

[gmpopcorn.com](http://gmpopcorn.com)

Phone: (800) 543-0862      Fax: (800) 542-1496  
(513) 769-7676              (513) 769-8500

© 2015 – The text, descriptions, graphics, layout, and other material in this publication are the exclusive property of Gold Medal Products Co. and shall not be used, copied, reproduced, or published in any fashion, including website display, without its express written consent.