



Instruction Manual

X-15 Stainless Steel Whirlwind

Model No. 3015 Series





GOLD MEDAL® PRODUCTS CO.

10700 Medallion Drive, Cincinnati, Ohio 45241-4807 USA





SAFETY PRECAUTIONS

	⚠ DANGER
	<p>Machine must be properly grounded to prevent electrical shock to personnel. Failure to do so could result in serious injury, or death. Make sure all machine switches are in the OFF position before plugging the equipment into the receptacle. Keep cord and plug off the ground and away from moisture. Always unplug the equipment before cleaning or servicing. DO NOT immerse any part of this equipment in water. DO NOT use a water jet or excessive water when cleaning.</p> <p>008_012221</p>

	⚠ DANGER
	<p>Improper installation, adjustment, alteration, service, or maintenance can cause property damage, injury, or death. Any alterations to this equipment will void the warranty and may cause a dangerous condition. This appliance is not intended to be operated by means of an external timer or separate remote-control system. NEVER make alterations to this equipment. Read the Installation, Operating, and Maintenance Instructions thoroughly before installing, servicing, or operating this equipment.</p> <p>014_020416</p>

	⚠ WARNING
	<p>Floss head rotates at high speeds. Operator MUST keep hands and face clear of the floss head to avoid injury. Operator must wear eye protection. Keep all spectators at a reasonable distance, and use a Floss Bubble for added customer protection.</p> <p>015_062714</p>

	⚠ WARNING
	<p>Keep all foreign objects out of floss head. To avoid eye injury, DO NOT fill floss head with sugar while the head is on and rotating.</p> <p>016_010914</p>

	⚠ WARNING
	<p>Burn Hazard. DO NOT touch spinner head. Allow to cool before cleaning or servicing. Avoid contact with molten sugar.</p> <p>006_092414</p>

	⚠ WARNING
	<p>ALWAYS wear safety glasses when servicing this equipment.</p> <p>010_010914</p>



	WARNING
	No user serviceable parts inside. Refer servicing to qualified service personnel. 011_051514

	WARNING
	Read and understand operator's manual and all other safety instructions before using this equipment. To order copies of the operator's manual go to gmpopcorn.com or write to Gold Medal Products Co., 10700 Medallion Drive, Cincinnati, OH 45241 USA 1-(800)-543-0862 022_060215

	WARNING
	DO NOT allow direct contact of this equipment by the public when used in food service locations. Only personnel trained and experienced in the equipment operation may operate this equipment. Carefully read all instructions before operation. 012_010914

	WARNING
	This machine is NOT to be operated by minors. 007_010914

This appliance is not intended for use by persons (including children) with reduced physical, sensory or mental capabilities, or lack of experience and knowledge, unless they have been given supervision or instruction concerning use of the appliance by a person responsible for their safety.

DO NOT install equipment in an area where a water jet is used.

Unit to be installed in locations where ambient temperatures are between a minimum of 5°C (41°F) and a maximum of 55°C (131°F).

Unit to be installed in locations where it can be overseen by trained personnel.

Install unit on a level surface.

Unit is for cotton candy.

Note: Improvements are always being made to Gold Medal's equipment. This information may not be the latest available for your purposes. It is critical that you call Gold Medal's Technical Service Department at 1-800-543-0862 for any questions about your machine operations, replacement parts, or any service questions. (Gold Medal Products Co. does not assume any liability for injury due to careless handling and/or reckless operation of this equipment.) General images may be used in manual for reference only.

INSTALLATION INSTRUCTIONS

Inspection of Shipment

After unpacking, check thoroughly for any damage which may have occurred in transit. Claims should be filed immediately with the transportation company. The warranty does not cover damage that occurs in transit, or damage caused by abuse, or consequential damage due to the operation of this machine, since it is beyond our control (reference warranty in back of manual).

Manual

Read and understand the operator's manual and all other safety instructions before using this equipment. To order copies of the operator's manual go to gmpopcorn.com or write to Gold Medal Products Co., 10700 Medallion Drive, Cincinnati, OH 45241 USA 1-(800)-543-0862.

Setup

Your new floss machine unit is completely assembled and tested at the factory. Remove all packing material and tape before starting operation.

1. You **MUST** remove the 4 shipping brackets placed around the motor mount casting before operation. To do so, remove the bolts that hold the brackets in; this can be done with any wrench or socket. Failing to do so may result in damage to your floss machine or in personal injury.
2. Make sure the floss ribbon (heating element) located inside the head assembly has not shaken out of the band during transportation. If the ribbon is out of the band, push it back into place manually.

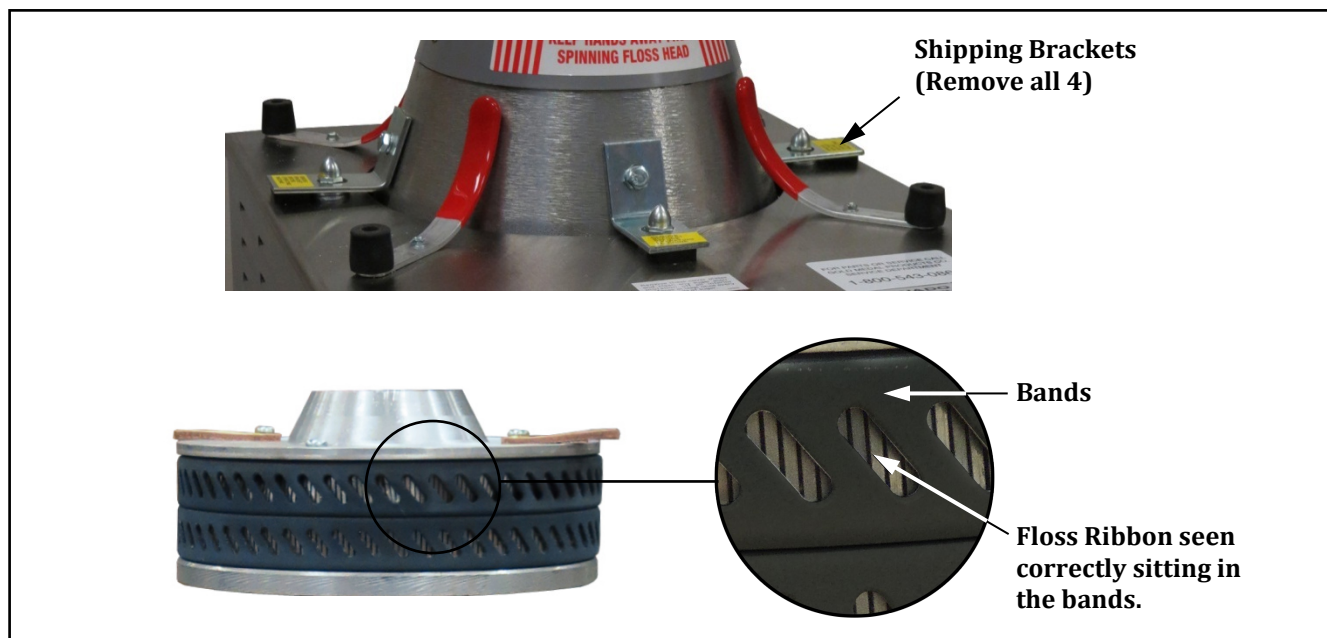



Electrical Requirements

The following power supply must be provided (reference unit Data Plate for Wattage requirement):

3015A, 3015PE: 120 V~, 60 Hz

3015AX, 3015AXA: 220-230 V~, 50/60 Hz

Potential Electrical Variations: 220 V~, 60 Hz

	⚠ DANGER
	<p>Machine must be properly grounded to prevent electrical shock to personnel. Failure to do so could result in serious injury, or death. Make sure all machine switches are in the OFF position before plugging the equipment into the receptacle. Keep cord and plug off the ground and away from moisture. Always unplug the equipment before cleaning or servicing. DO NOT immerse any part of this equipment in water. DO NOT use a water jet or excessive water when cleaning.</p> <p>008_012221</p>

A certified electrician must furnish sufficient power for proper machine operation and install any supplied receptacle (reference unit Data Plate for model specific Volts AC, Hertz, and Wattage requirements). We recommend this equipment be on a dedicated and protected circuit. Failure to wire properly will void the warranty and may result in damage to the machine. It is Gold Medal Products Co.'s recommendation that this machine be plugged directly into a wall outlet. The use of extension cords is not recommended due to safety concerns, and may cause sacrificed and/or reduced performance. Make sure cord is located to prevent a trip hazard or unit upset.

Before You Plug In Machine

1. Make sure all machine switches are OFF before plugging equipment into receptacle.
2. Make sure wall outlet can accept the grounded plugs (where applicable) on the power supply cord.
3. The wall outlet must have the proper polarity. If in doubt, have a competent electrician inspect the outlet and correct if necessary.
4. **DO NOT** use a grounded to un-grounded receptacle adapter (where applicable).
5. Install unit in a level position.

	⚠ CAUTION
	<p>If the supply cord is damaged, it must be replaced by Gold Medal Products Co., its service agent or similarly qualified persons in order to avoid a hazard.</p> <p>039_080614</p>

Whirlgrip Floss Stabilizer

Installation Instructions

Unit must be OFF, and cool to install Floss Stabilizer. Place Floss Pan on unit and install Whirl Grip Floss Stabilizer (Item No. 3010) as shown below. Kit includes: Floss Stabilizer/screening (P/N 43032), and (6) Whirlgrip Clips (P/N 77470). Clips are designed to provide air space between screening and floss pan.

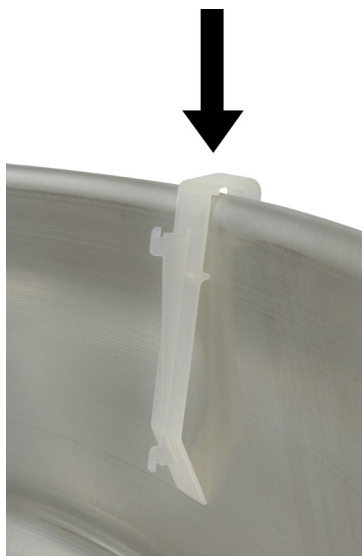

Step 1: Place Whirl Clips over rim of pan with hooks facing inside.

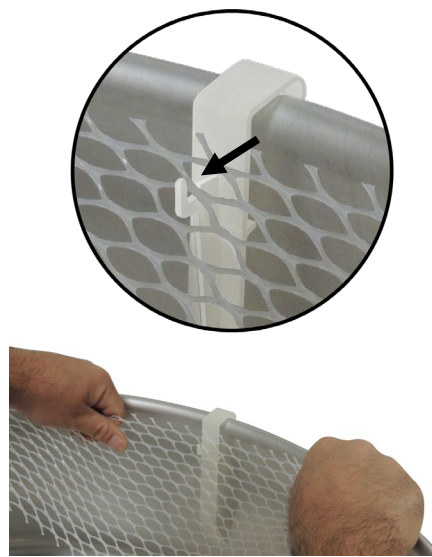

Step 2: Hang Stabilizer on top, up facing hook. Screening should be about flush with top of pan.

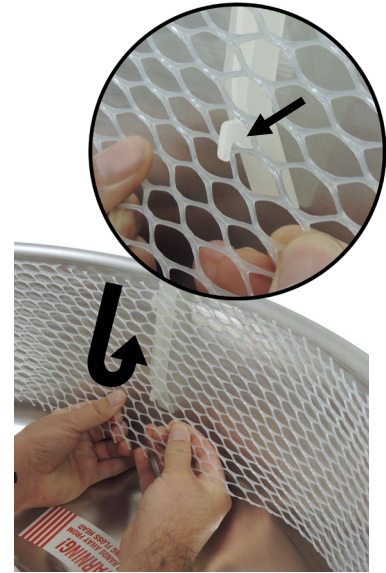

Step 3: Gently pull screening down and attach to bottom, down facing hook.

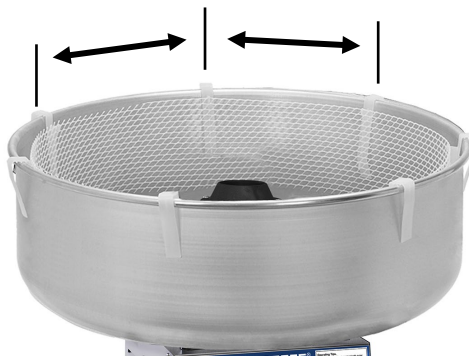

Allow **air space** for proper operation.

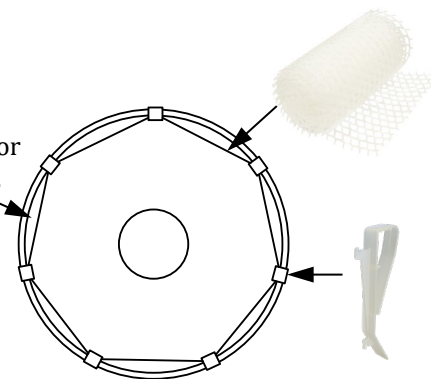

Top View of Floss Pan

Step 4: Repeat for all clips keeping equal spacing around pan (number of clips varies by model). Allow air space between pan and screening for proper operation.



OPERATING INSTRUCTIONS

Controls and Their Functions

MAIN SWITCH (Motor Switch)

Turns motor “ON” or “OFF” and supplies voltage to the heat switch.

HEAT SWITCH

Turns voltage to the heating element (ribbon) “ON” or “OFF”.

HEAT CONTROL KNOB

Increases or decreases power to heating element (ribbon) using a graduated dial.

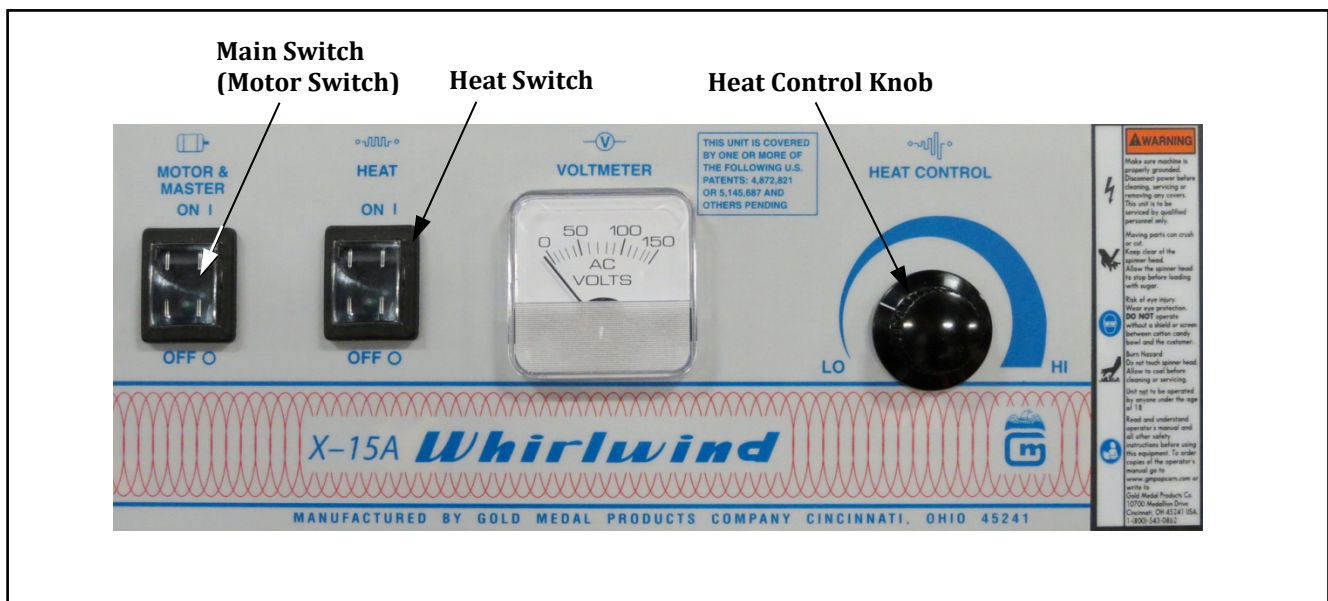



Sugar for Your Candy

Ready to Use Flossugar

Our ready to use Flossugar is the preferred sugar for your new cotton candy machine; however 100% pure cane or beet sugar will do just fine. Our Flossugar gives you good rich colors, and great flavors, too. It is packed in handy half-gallon sealed cartons, with an E-Z pour spout for filling your machine. Flossugar comes in many flavors, and you can easily change flavors for greatest variety, and best sales.

Mix Your Own

If you want to mix your own use our Flossine[®], please follow our directions. If you want a deeper color slightly dampen the mixed sugar. Use a tablespoon of water per five pounds of sugar, sprinkle water over sugar, and mix well. **DO NOT USE EXCESS COLOR!** Too much color will ruin the ribbons on your machine and could create a bitter taste to the candy. There is a limit as to how dark you can make cotton candy. That's because cotton candy is 98% air, and we cannot color the air.

Sugar Considerations

Today 99% of the sugar manufactured is extra fine granulated, which does have some small particles which can slip thru the ribbons without being melted. If this becomes objectionable, you can seek out medium coarse or sanding sugars. The larger crystal size will require a little more heat to melt.

Today we see some free flowing sugars for restaurants. Free flowing sugars contain cornstarch which will burn onto your ribbons clogging them rapidly. We have also seen some off-brand sugars that are a blend of sugar and dextrose or corn syrup. This product makes very poor cotton candy. Please make sure you get good sugar for your cotton candy machine.



HEAT CONTROL SETTINGS TEST

Settings Test

	⚠ CAUTION
	Floss head operates at high speeds. Operator MUST keep hands and face clear of the floss head to avoid possible injury. Keep all spectators at a reasonable distance, and use a Floss Bubble for added customer protection.

1. Follow the guidelines described on page 4 for supplying power to machine.
2. With Main Switch still off, fill floss head. Always fill it 90% full with sugar. This 90% level is necessary to obtain a balanced condition in the floss head. **DO NOT OVERFILL!** Excessive vibration will occur if overfilled. Before turning the power on, manually turn the head to balance out the sugar. This will eliminate excessive vibration of the head.

Important: NEVER add sugar when motor is running.

3. Turn the Main Switch and Heat Switch "ON".
4. Turn the Heat Control Knob clockwise to maximum setting to initiate the fastest possible warm up.
5. The machine should start making floss in a few seconds. When the unit starts making floss, you must reduce the heat setting. Turn the Heat Control Knob counter clockwise to eliminate smoking. If you operate the unit at "startup" setting, you will carbonize the ribbon.

	⚠ CAUTION
	Never operate the equipment for a prolonged period of time with the HEAT CONTROL in a position that causes the sugar to smoke. This will result in excessive carbonization of the ribbon (heat element). If you smell burning sugar or see smoke, reduce the heat.

6. Once you find the ideal setting for the HEAT CONTROL, operate with the setting near this position each time. The machine will automatically adjust to keep the power to the head constant during incoming voltage changes from the power source.
7. When the floss head needs to be refilled with sugar, or to stop the machine, turn the Heat Switch OFF and allow the motor to run for a few seconds to start cooling down the floss head, then turn the Motor & Master Switch OFF.

When completing operation for the day (or any prolonged period), follow the instructions in the Shutdown Procedure/Cleaning and Care section of this manual.



Making Floss

Pick a cone, if it sticks in the stack of cones, twist it off the stack.

	CAUTION
	Keep hands away from spinning head!

031_021914

Hold an inch or two of the pointed end of the cone between two fingers and a thumb. With a light flicking action, roll cone in the web of floss building up in the pan. Lift the cone up with the ring of floss attached and rotate the cone to wrap the floss. **DO NOT** roll floss while the cone is inside the pan. This will pack the floss too tightly. See steps 1 thru 8 shown below.

If the floss fails to stick to the cone, pass the cone near the spinner head to pick up a "starter" of melted sugar. Lift the cone out of the pan and wrap the floss with a "figure eight" movement of the hand. This leaves giant pockets and makes the final product appear larger. Make sure room humidity is not too high, or product will be "heavy".

1. Grip cone as shown. 	2. Break into web of floss with the cone. 	3. Wind the sugar onto the cone. 	4. Lift web of floss from the pan and roll onto the cone.
5. 	6. 	7. 	8.

	WARNING
	<ul style="list-style-type: none">• DO NOT PUT HANDS OR OBJECTS IN ROTATING SPINNER HEAD.• DO NOT FILL SPINNER HEAD WITH SUGAR WHILE IT IS ROTATING.• WEAR EYE PROTECTION.• DO NOT PUT HANDS NEAR ROTATING SPINNER HEAD.• USE FLOSS CONE TO COLLECT COTTON CANDY.

032_021914

FLOATER ADJUSTMENTS

In operation, the floss will collect on the FLOSS STABILIZER. If the floss collects “low” on the stabilizer, twist the front (leading) edge of the leather floaters down. You get more lift and the floss will collect higher.

Form leather floaters as shown below. This creates a lifting action to float the floss higher on the outside wall of the floss pan.

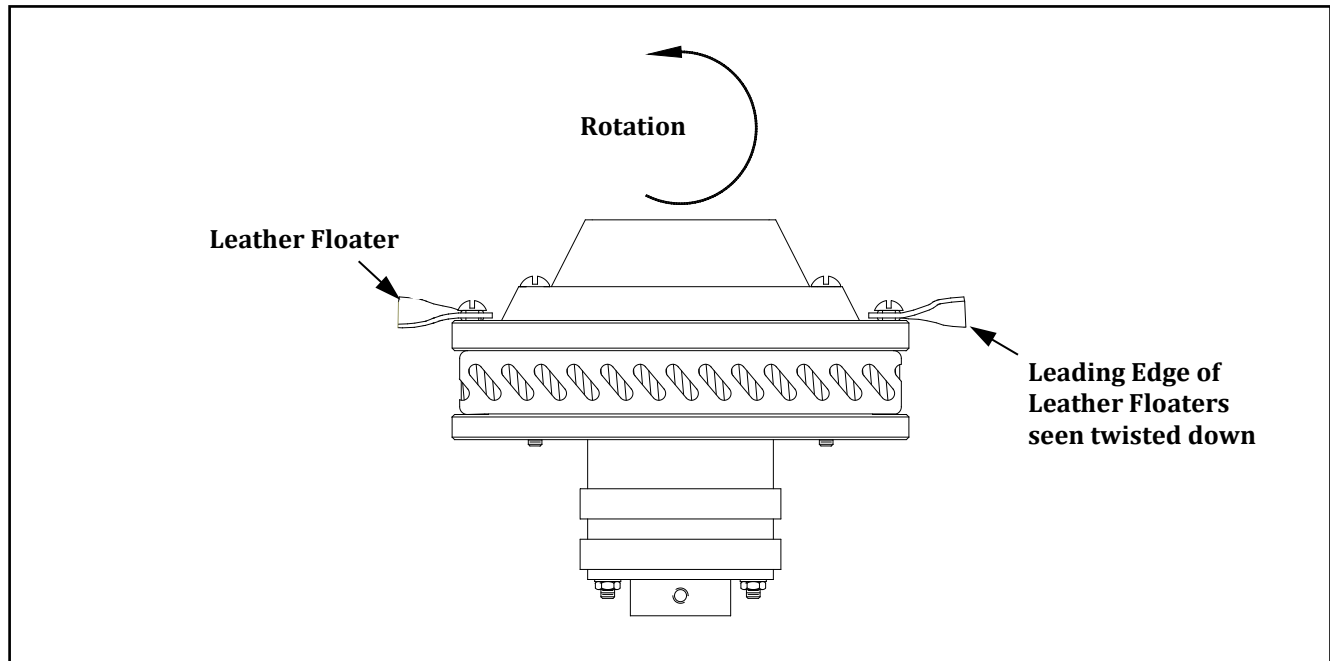

Shut Down Procedure

When completing operation for the day (or any prolonged period), run all the sugar out of the floss head. When empty, turn the heat to highest position for approximately one minute to “clean” the band by baking off remaining sugar. **NEVER** put water in the floss head.

Cleaning Instructions

Unplug the machine and wait for the floss head to cool down to room temperature. Wipe all surfaces with a clean, damp cloth.

Take pan and accessories to sink to clean with soap and water then rise and allow to dry. **DO NOT use oven cleaners or abrasive materials** as they will damage parts of machine.

Floss Bands and Ribbons

Gold Medal Floss Bands are designed to give long life and trouble-free service with little care. **DO NOT** scratch the band. Gold Medal Floss Ribbons (heat elements) are made of nickel wire with insulation at the terminal point and on the lead wires. They are designed to be as reliable as the bands; however, the ribbons must be handled carefully. **DO NOT** stretch the ribbon or it will not function properly.

Disassembly and Removal of Floss Band

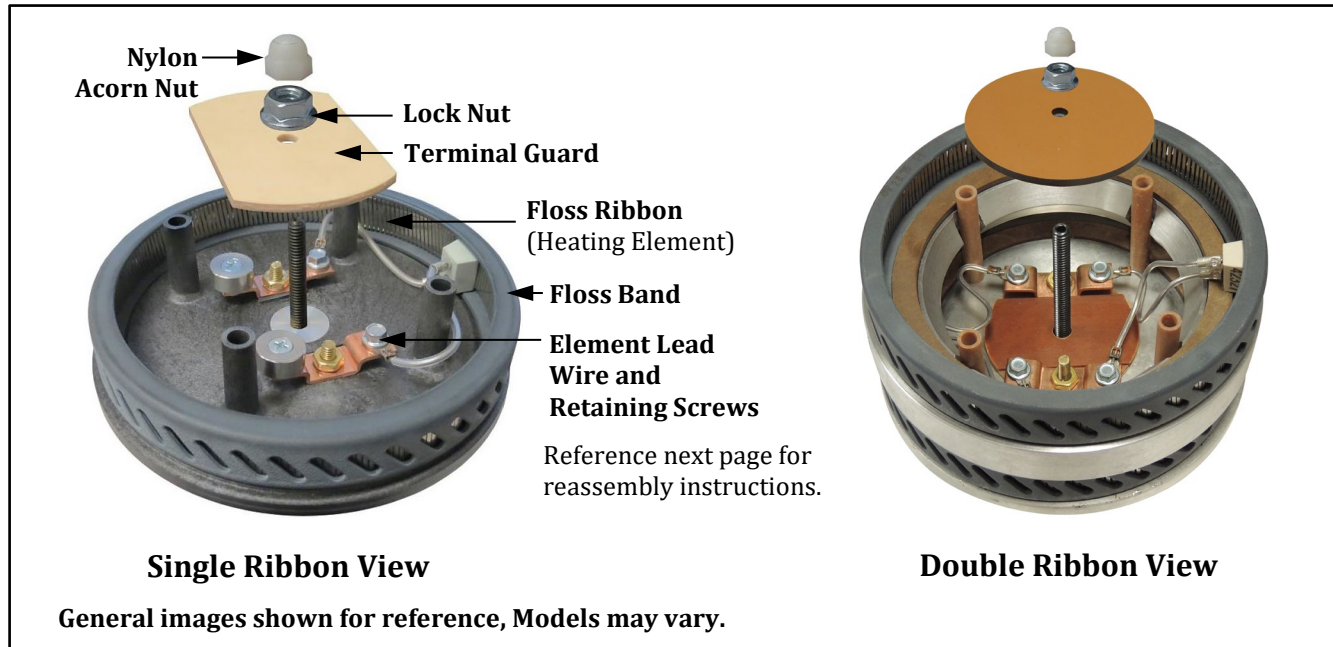

1. Unplug the machine from the power source and allow floss head to cool completely.
2. Remove all sugar from the head of the machine before disassembling. If needed, carefully turn the machine on its side and shake the sugar out.
3. Remove the four spinner cap retainer screws and spinner cap. In some cases, the sugar has caused the cap and band to stick together. Applying gentle pressure with the heel of the hand should free the parts for removal.
4. Remove the nylon acorn nut, lock nut, and terminal guard.
5. Remove the element lead wire retaining screws (using a 1/4" (9.5mm) nut driver), which fasten the element lead wires to the terminals. This will allow the band and ribbon(s) to be removed. **DO NOT PULL OR STRETCH RIBBON(S) TO REMOVE.** (See appropriate reassembly section for reconnecting element leads.)
6. If there is excessive sugar buildup, soak the band and ribbon(s) in hot water until the sugar dissolves. When the sugar has been removed, tap the band in the palm of your hand to loosen the ribbon(s) for removal.



7. Inspect, then clean or replace the band and ribbon(s). The primary reason for ribbon replacement is carbon build up inside the ribbon; an additional hot water soak may help remove some of the carbon buildup.
8. When the sugar has been removed, allow the band and element(s) to air dry overnight.

Note: For models with separate heat and motor switches, the best way to dry the floss head after reassembly is to spin it dry for 10 minutes **WITHOUT HEAT** (use motor switch only).

Reassembly of Floss Band – Units with Terminal Assemblies

1. Reinstall band and ribbon(s) on the spinner head; **ALWAYS** attach one ribbon element lead to each terminal assembly (see below; units with terminal jumper see next section).
2. Reassemble terminal guard, lock nut, and nylon acorn nut.
3. When reinstalling the spinner cap, **DO NOT OVERTIGHTEN SCREWS**. Initially snug down each screw evenly, be careful not to over apply pressure on any single point and crack the band coating. Once snug, tighten all screws evenly to secure spinner cap to floss head.

Terminal Assemblies



CORRECT

Connect **ONE** ribbon element lead to **EACH** terminal assembly.

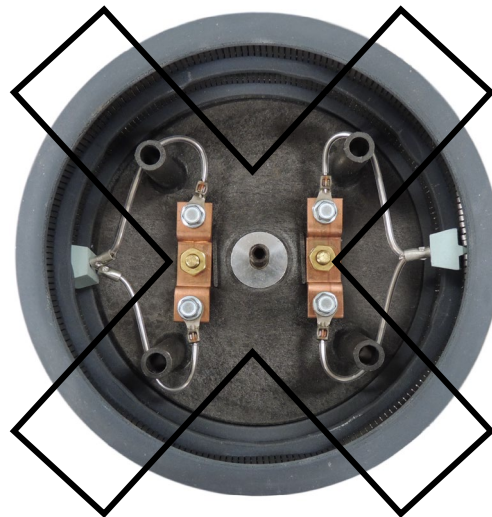

INCORRECT

DO NOT connect both ribbon element leads to the same terminal assembly.

Double Ribbon Floss Head with Terminal Assemblies

General double ribbon view shown for reference, Models may vary.



Reassembly of Floss Band – Export Units with Terminal Jumper

1. Reinstall band and ribbon(s) on the spinner head; for each element, ALWAYS attach one element lead to a brass stud, and one lead to a stainless steel screw as shown in image below. ALWAYS attach Jumper to the stainless steel screws.
2. Reassemble terminal guard, lock nut, and nylon acorn nut.
3. When reinstalling the spinner cap, **DO NOT OVERTIGHTEN SCREWS**. Initially snug down each screw evenly, be careful not to over apply pressure on any single point and crack the band coating. Once snug, tighten all screws evenly to secure spinner cap to floss head.

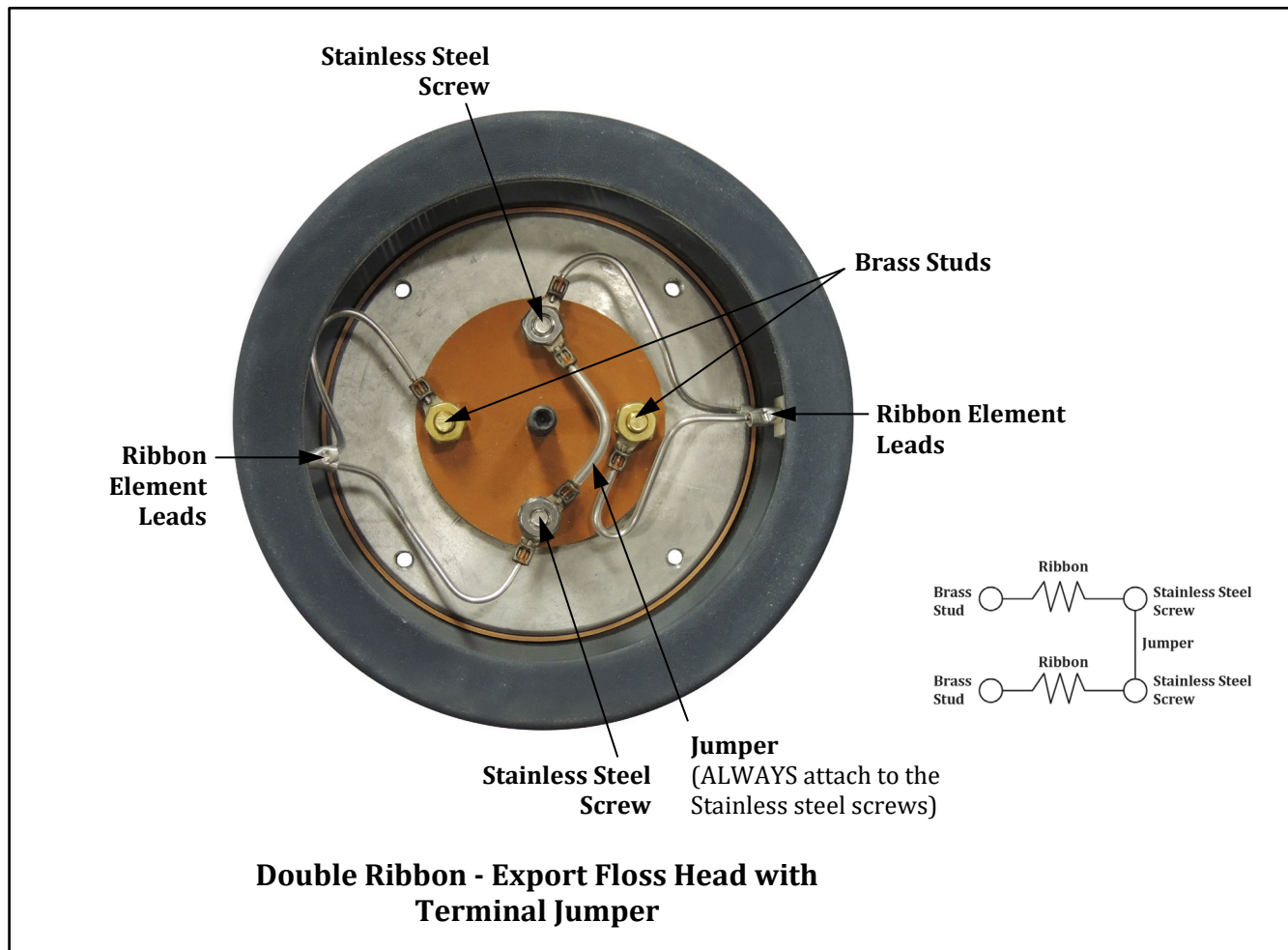



TROUBLESHOOTING

Low Production

- Check for excessive carbon on the ribbons. Follow the instructions for removing and cleaning band and ribbon if needed.
- Check heat control for correct setting.
- Check the line voltage. A primary reason for low production and poor equipment performance is low line voltage. Have an electrician check the line voltage and add new lines for all of the various equipment you have plugged into the electric circuit if there is not enough current for the requirement listed on the equipment nameplate.
- Check the ribbons. For machines with two ribbons, one burned out or shorted ribbon will cut production in half.
- Foreign objects in the head assembly may short out a ribbon or cause an out-of-balance condition.

Excessive Smoke

- Check heat control setting. After warm up, equipment should make good floss at a reduced setting. Never let the machine operate with the heat so high it produces smoke or if you can smell burned sugar. This condition quickly fills the ribbon with carbonized sugar.
- Check the product mixture being used. For best results, use nothing with a cornstarch base.
- Check the band and ribbon for excessive sugar build up and remove if needed as described on page 11 of this manual.



Excessive Vibration



- If the equipment is new, verify that shipping bolts have been loosened and packing materials were removed from the machine.
- When adding sugar to the floss head, always fill it 90% full to obtain a balanced condition in the head and eliminate vibration. **DO NOT** add sugar with motor running!
- Check for stretched or uneven suspension springs.
- Run the sugar completely out, then check for foreign objects or sugar lumps in the head assembly.







—THE FOLLOWING SECTIONS ARE FOR QUALIFIED SERVICE PERSONNEL ONLY—

MAINTENANCE INSTRUCTIONS

	 DANGER
	<p>Machine must be properly grounded to prevent electrical shock to personnel. Failure to do so could result in serious injury, or death. Make sure all machine switches are in the OFF position before plugging the equipment into the receptacle. Keep cord and plug off the ground and away from moisture. Always unplug the equipment before cleaning or servicing. DO NOT immerse any part of this equipment in water. DO NOT use a water jet or excessive water when cleaning.</p> <p>008_012221</p>

	 DANGER
	<p>Improper installation, adjustment, alteration, service, or maintenance can cause property damage, injury, or death. Any alterations to this equipment will void the warranty and may cause a dangerous condition. This appliance is not intended to be operated by means of an external timer or separate remote-control system. NEVER make alterations to this equipment. Read the Installation, Operating, and Maintenance Instructions thoroughly before installing, servicing, or operating this equipment.</p> <p>014_020416</p>

	 WARNING
	<p>No user serviceable parts inside. Refer servicing to qualified service personnel.</p> <p>011_051514</p>

	 CAUTION
	<p>THE FOLLOWING SECTIONS OF THIS MANUAL ARE INTENDED ONLY FOR QUALIFIED SERVICE PERSONNEL WHO ARE FAMILIAR WITH ELECTRICAL EQUIPMENT. THESE ARE NOT INTENDED FOR THE OPERATOR.</p> <p>027_010914</p>

HOW TO CHECK A TRIAC

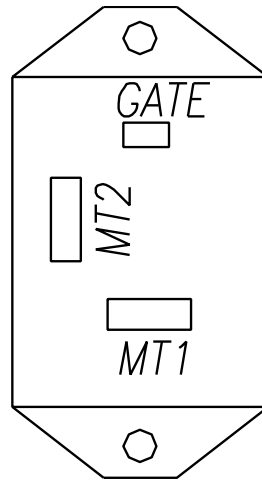

Triac - Top View

1. Set the multimeter for ohms or continuity.
2. Disconnect all machine leads from the triac.
3. Connect the positive ohmmeter lead to MT2 and the negative lead to MT1. The ohmmeter should indicate no continuity (OL) through the triac.
4. Using a separate jumper lead, connect the gate of the triac to MT2. The ohmmeter should indicate continuity. (less than 100 ohms)
5. Reconnect the triac so MT1 is connected to the positive ohmmeter lead and the negative lead to MT2. The ohmmeter should indicate no continuity (OL) through the triac.
6. Using a separate jumper lead, connect the gate of the triac to MT2. The ohmmeter should indicate continuity. (less than 100 ohms)



ORDERING SPARE PARTS

1. Identify the needed part by checking it against the photos, illustrations, and/or parts list. (General images may be used in manual for reference only.)
2. Use only approved replacement parts when servicing this unit.
3. When ordering, please include part number, part name, and quantity needed.
4. Please include your model number, serial number, and date of manufacture (located on the machine nameplate/data plate) with your order.
5. Address all parts orders to Parts Department, Gold Medal Products Co., 10700 Medallion Drive, Cincinnati, Ohio 45241-4807

or place orders by phone or online:

Phone: (800) 543-0862
(513) 769-7676

Fax: (800) 542-1496
(513) 769-8500

E-mail: info@gmpopcorn.com
Web Page: gmpopcorn.com



Exterior View

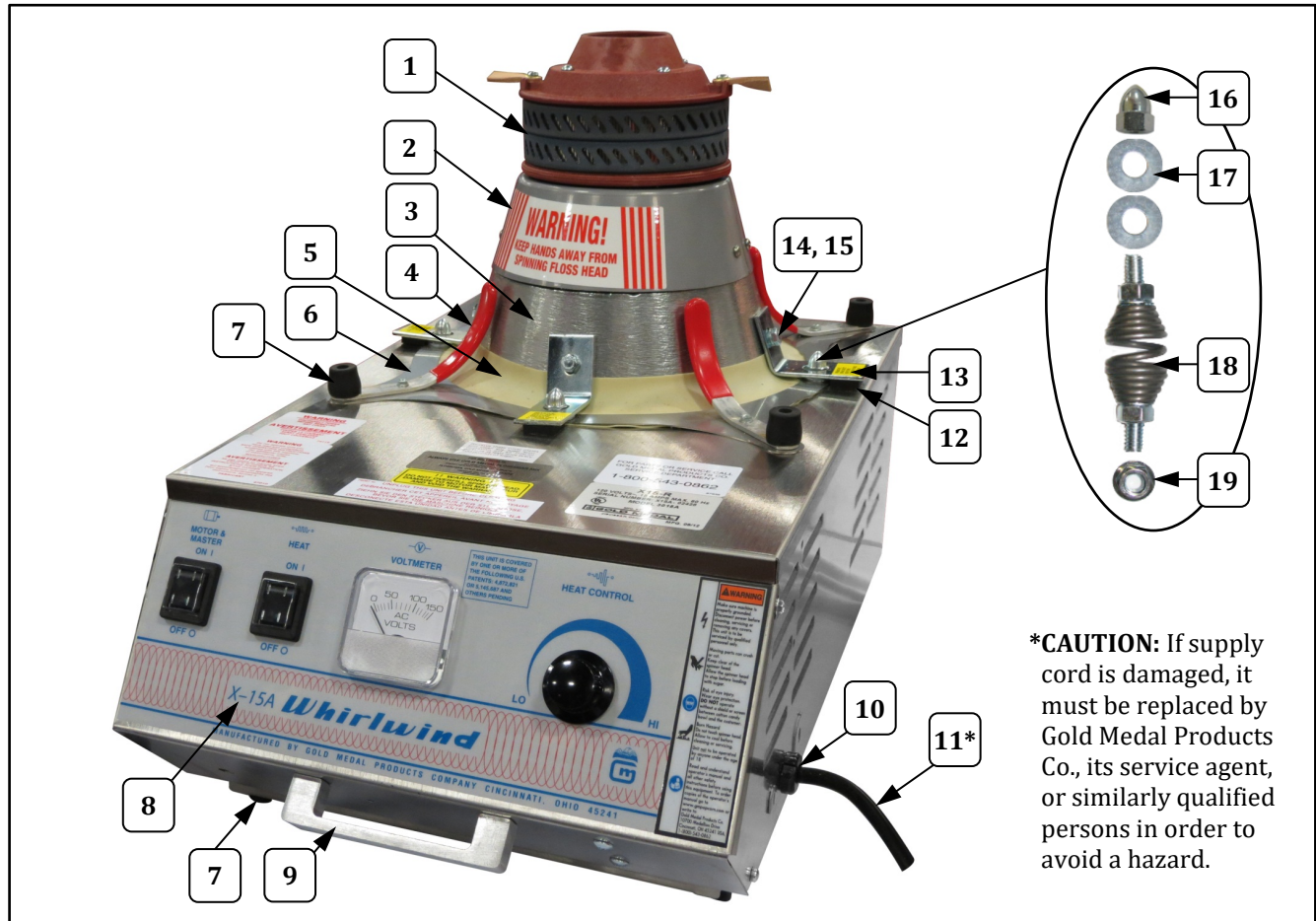

***CAUTION:** If supply cord is damaged, it must be replaced by Gold Medal Products Co., its service agent, or similarly qualified persons in order to avoid a hazard.

Item	Part Description	Qty.	Part Number			
			3015A	3015PE	3015AX	3015AXA
1	5 IN SPINNER HEAD COMPLETE	1	42389	42389PE	42389EX	42325EX
2	BRUSH COVER	2	42008NM	42008NM	42008NM	42008NM
3	MOTOR CASTING	1	42034	42034	42034	42034
4	PAN SUPPORT	4	42049	42049	42049	42049
5	BELL HOUSING SEAL	1	48787	48787	48787	48787
6	BELL HOUSING SEAL RETAINER	4	42505	42505	42505	42505
7	RUBBER FEET 3/4IN HIGH	8	47155	47155	47155	47155
8	NAME & INSTRUCTION PLATE	1	48652	48652	48652EX	48652EX
9	HANDLE	1	67069	67069	67069	67069
10	STRAIN RELIEF SR7W-2	1	67060	67060	67060	67060
11	POWER SUPPLY CORD	1	87085	87085	42369	42369
12	RUBBER PAD	4	75243	75243	75243	75243
13	SUPPORT ANGLE, SHIPPING	4	48019	48019	48019	48019
14	1/4-20 X 1 HHC GR2 ZINC	4	41903	41903	41903	41903
15	MED SPLIT LOCK WASHER 1/4	4	74526	74526	74526	74526
16	5/16 ACORN NUT	4	77610	77610	77610	77610
17	5/16 WASHER	8	74134	74134	74134	74134
18	SUSPENSION SPRING	4	20006	20006	20006	20006
19	5/16 FLANGE NUT	4	49317	49317	49317	49317



Front Panel

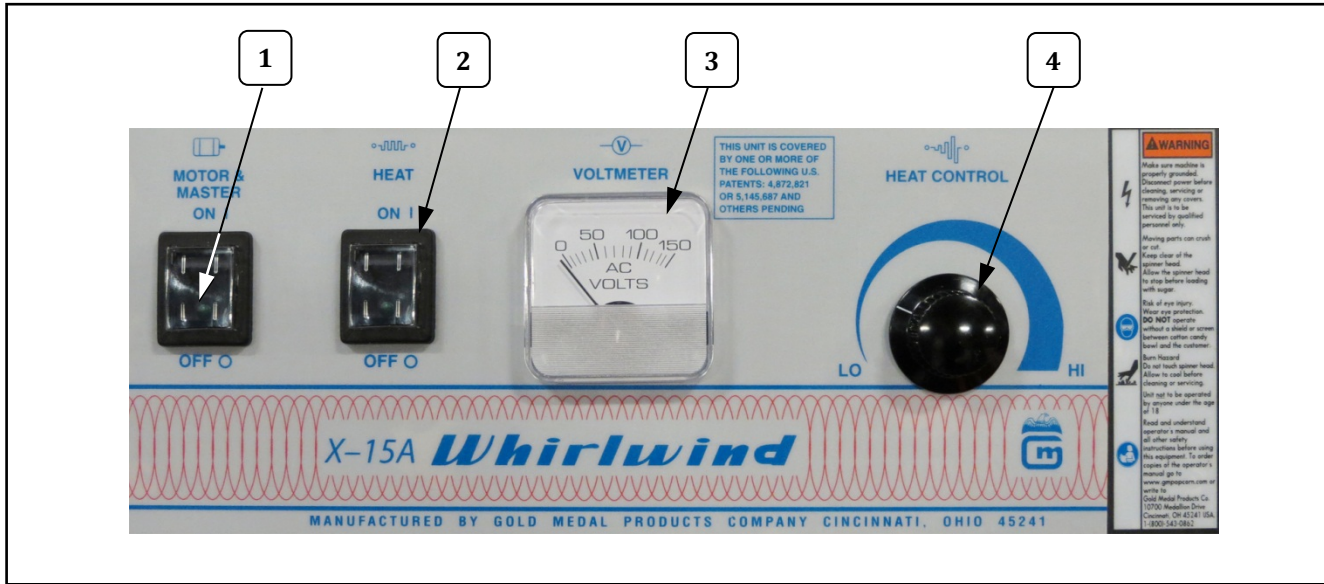

Item	Part Description	Qty.	Part Number		
			3015A, 3015PE	3015AX	3015AXA
1	SWITCH, LIGHTED ROCKER GR	2	42798	42798	42798
2	ROCKER SWITCH COVER	2	48786	48786	48786
3	VOLTMETER	1	42411	55470A	55470A
4	KNOB, PAKTRONIC CONTROL	1	40793	40793	40793



Spinner Head Assembly – Model 3015A, 3015PE (Domestic)



**Complete Spinner Head
Model 3015A**

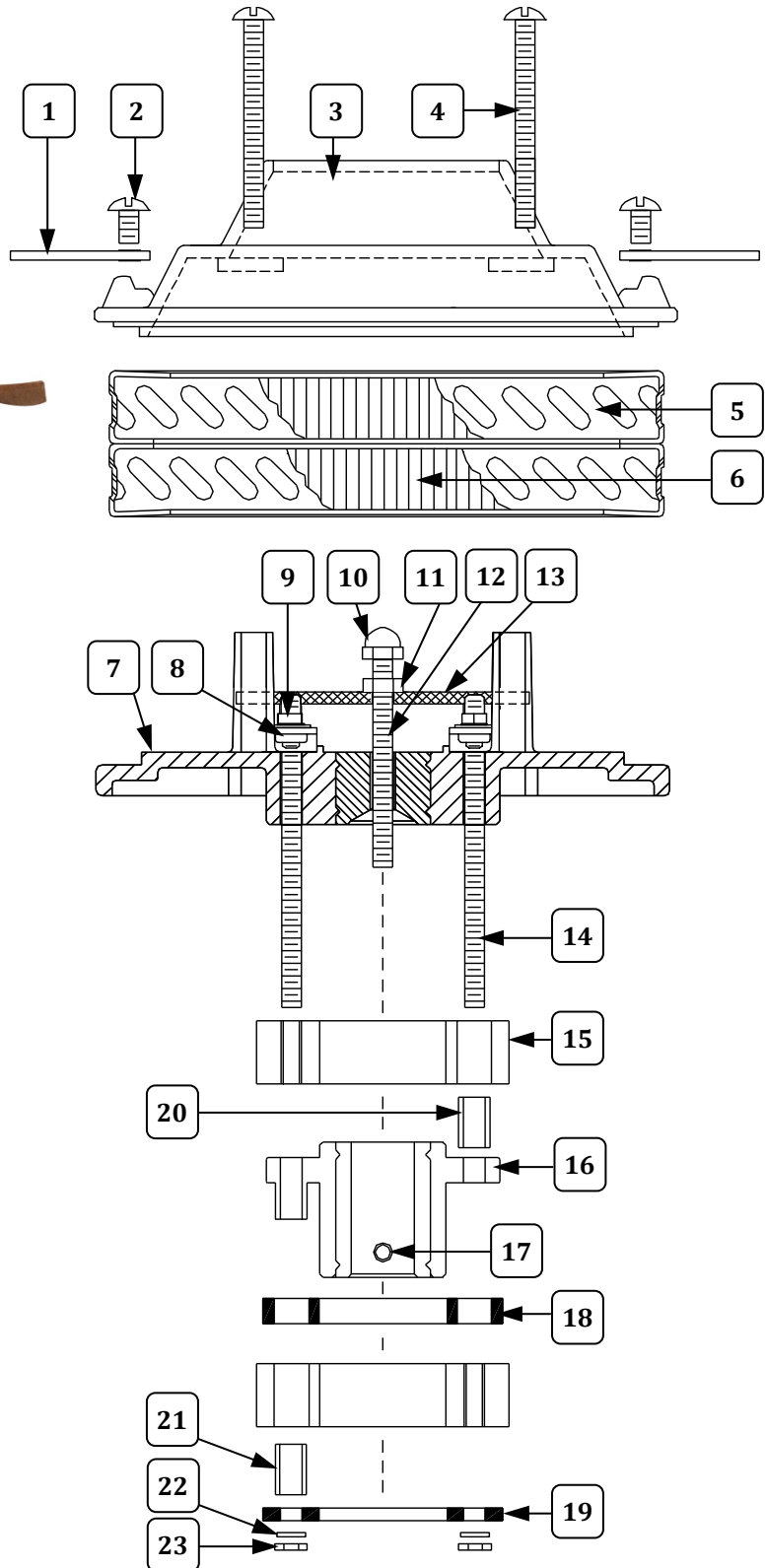



Spinner Head Assembly – Parts List - 3015A, 3015PE (Domestic)

Item	Part Description	Qty.	Part No.	
			3015A	3015PE
	SPINNER HEAD COMPLETE	1	42389	42389PE
1	LEATHER FLOATER	2	20010	20010
2	SCREW 8-32 X 5/16 PH PAN MS	2	89247	89247
3	HIGH CAPACITY SPINNER CAP	1	43166	43166
4	10-24 X 2 3/4 PH PAN M/S	4	42199	42199
5	5 1/2 IN DBL FLOSS BAND	1	42517	42517PE
6	3077/3015A RIBBON ASSY (For 5 IN Ribbon Replacement of PN 42564, Customer Order PN 42565)	2	42564	42564
7	UPPER SPINNER HEAD, 5 IN	1	48671	48671
8	TERMINAL ASSY	2	42305	42305
9	8-32 X 1/4 HX HD WHIZLOCK	4	42045	42045
10	ACORN NUT NYLON 1/4-20	1	48041	48041
11	1/4-20 SERRATED LOCK NUT	1	46311	46311
12	SET SCREW 1/4-20 X 2-3/4	1	42413	42413
13	PHENOLIC TERMINAL GUARD	1	42162	42162
14	HEAD STUD 3 1/2 LG, BRASS	2	42032	42032
15	SLIP RING 5/8 INCH	2	20020HD	20020HD
16	LOWER SPINNER HEAD 5/8	1	42438	42438
17	SET SCREW 1/4-20 X 3/8	1	74125	74125
18	TOP PHENOLIC WASHER	1	42025	42025
19	BOTTOM PHENOLIC WASHER.	1	20054	20054
20	STUD INSULATOR 5/8 IN	1	42030	42030
21	STUD INSULATOR 1/2 IN	1	42154	42154
22	#10 INTERNAL TOOTH WASHER	4	12573	12573
23	HEX NUT #10-32 BRASS	4	42301	42301



Spinner Head Assembly – Model 3015AX (Export)



**Complete Spinner Head
Model 3015AX**

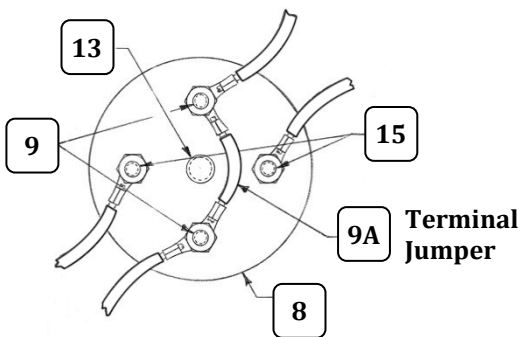
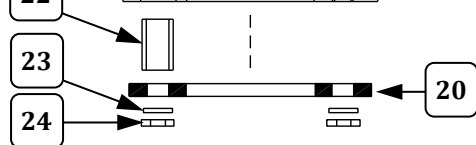
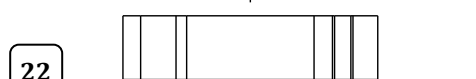
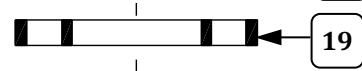
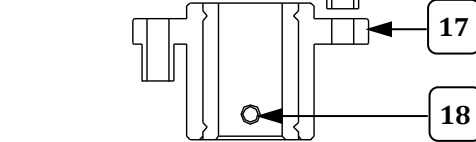
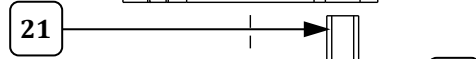
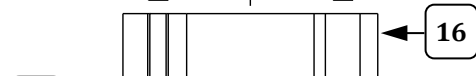
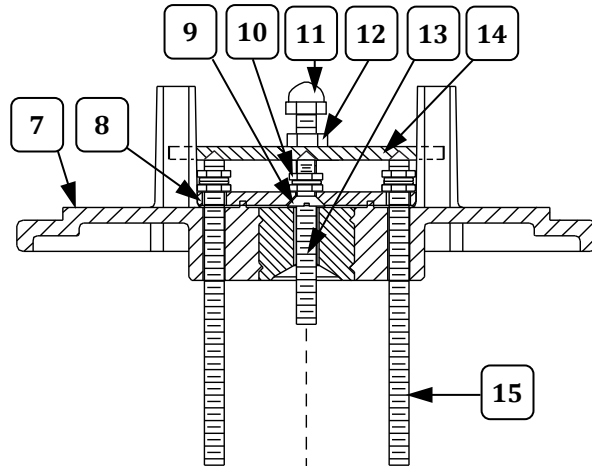
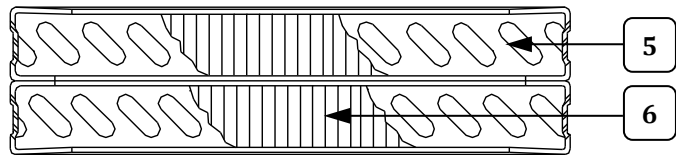
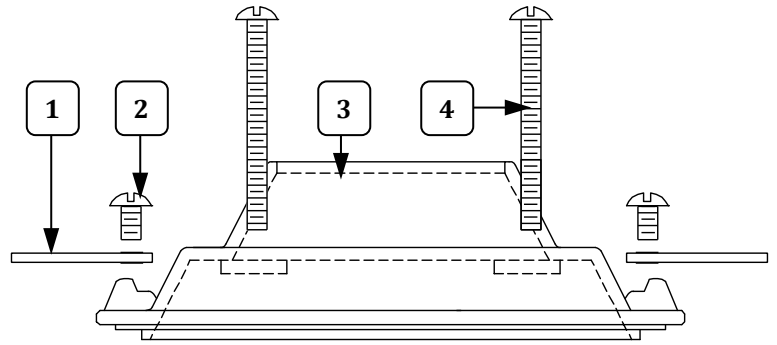

Terminal Wiring



Spinner Head Assembly – Parts List Model 3015AX (Export)

Item	Part Description	Qty.	Part No.
			3015AX
	SPINNER HEAD COMPLETE	1	42389EX
1	LEATHER FLOATER	2	20010
2	SCREW 8-32 X 5/16 PH PAN MS	2	89247
3	HIGH CAPACITY SPINNER CAP	1	43166
4	10-24 X 2 3/4 PH PAN M/S	4	42199
5	5 1/2 IN DBL FLOSS BAND	1	42517
6	5 IN RIBBON, 120 8A (For 5 IN Ribbon Replacement of PN 42327, Customer Order PN 20005)	2	42327
7	UPPER SPINNER HEAD, 5 IN	1	48671
8	TOP TERMINAL INSULATOR	2	42367
9	10-32 X 1/2 PHIL FLAT M/S	4	59052
9A	NICKEL LEAD ASSY 1.5 IN.	1	48706
10	HEX NUT #10-32 ZINC PLATED	4	74143
11	ACORN NUT NYLON 1/4-20	1	48041
12	1/4-20 SERRATED LOCK NUT	1	46311
13	SET SCREW 1/4-20 X 2-3/4	1	42413
14	PHENOLIC TERMINAL GUARD	1	42162
15	HEAD STUD 3 1/2 LG, BRASS	2	42032
16	SLIP RING 5/8 INCH	2	20020HD
17	LOWER SPINNER HEAD 5/8	1	42438
18	SET SCREW 1/4-20 X 3/8	1	74125
19	TOP PHENOLIC WASHER	1	42025
20	BOTTOM PHENOLIC WASHER.	1	20054
21	STUD INSULATOR 5/8 IN	1	42030
22	STUD INSULATOR 1/2 IN	1	42154
23	#10 INTERNAL TOOTH WASHER	10	12573
24	HEX NUT #10-32 BRASS	6	42301

Spinner Head Assembly – Model 3015AXA (Export)



1

Complete Spinner Head
Model 3015AXA

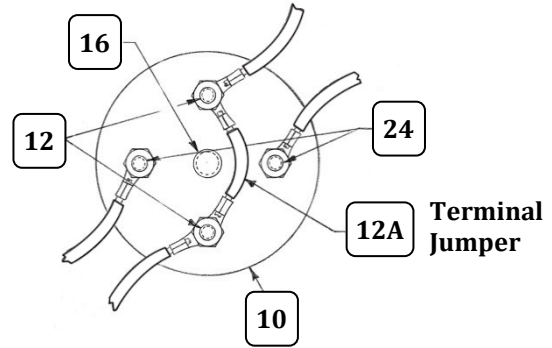

Terminal Wiring

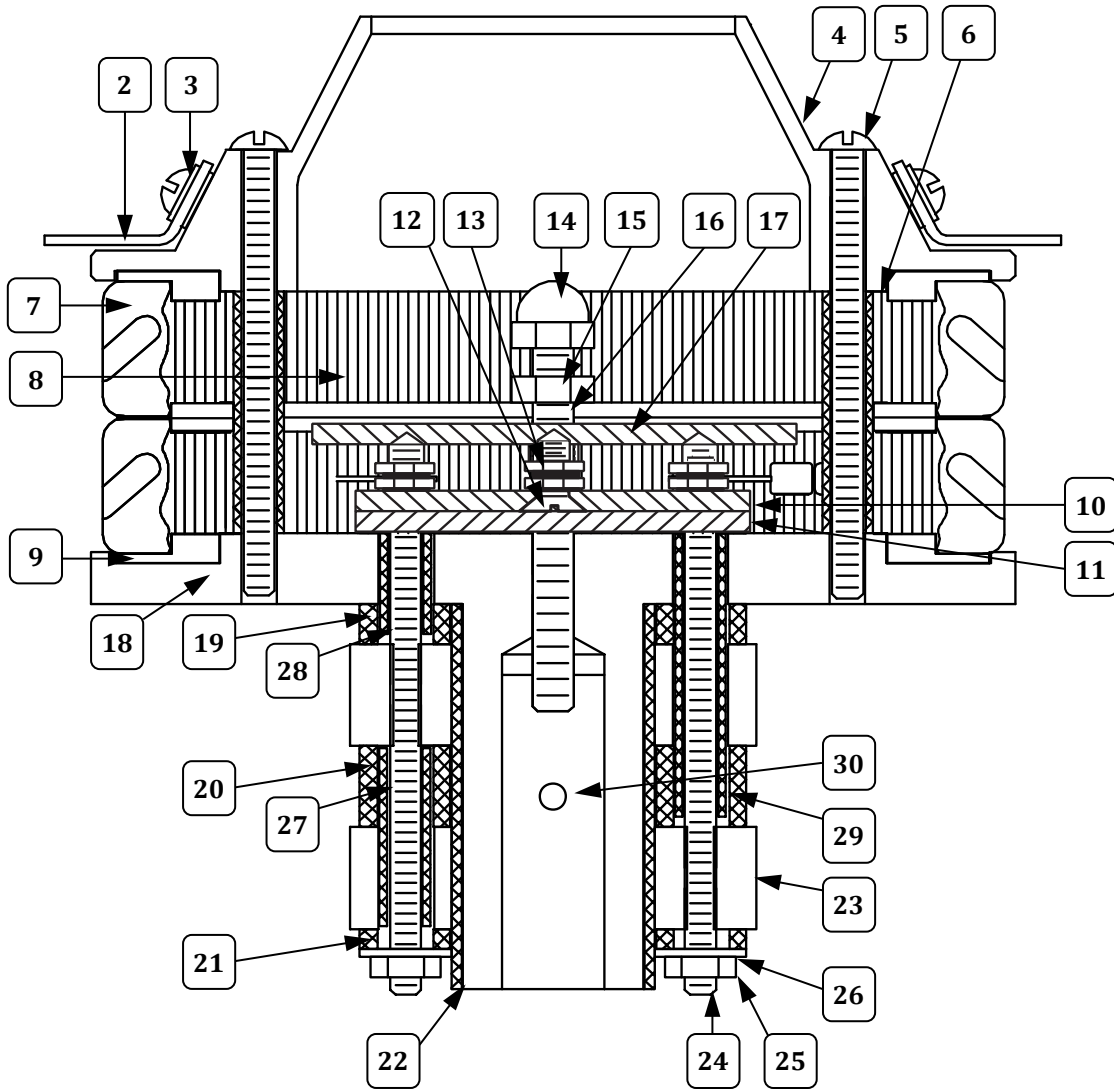



Spinner Head Assembly – Parts List Model 3015AXA (Export)

Item	Part Description	Qty.	Part No.
			3015AXA
	5 INCH SPINNER HEAD COMPLETE	1	42325EX
1	SPINNER HEAD BOTTOM ONLY	1	42318EX
2	LEATHER FLOATER	2	20010
3	8-32 X 5/16 PH PAN M/S	2	89247
4	SPINNER CAP HIGH CAPACITY	1	42170
5	10-24 X 2 3/4 PH PAN HEAD	4	42199
6	STUD INSULATOR 1-23/64 IN	4	42308
7	5 IN DBL FLOSS BAND	1	42213
8	5 IN RIBBON, 120 8A (For 5 IN Ribbon Replacement of PN 42327, Customer Order PN 20005)	2	42327
9	PHENOLIC BAND INSULATOR	2	42216
10	TOP TERMINAL INSULATOR	1	42367
11	BOTTOM TERMINAL INSULATOR	1	42368
12	10-32 X 1/2 PHIL FLAT M/S	2	59052
12A	NICKEL LEAD ASSY 1.5 IN.	1	48706
13	HEX NUT #10-32 ZINC PLATED	4	74143
14	ACORN NUT NYLON 1/4-20	1	48041
15	1/4-20 SERRATED LOCK NUT	1	46311
16	SET SCREW 1/4-20 X 2-3/4	1	42413
17	PHENOLIC TERMINAL GUARD	1	42303
18	HEAD CASTING	1	42053
19	TOP PHENOLIC WASHER	1	42025
20	CENTER PHENOLIC WASHER	1	42026
21	BOTTOM PHENOLIC WASHER.	1	20054
22	INSULATOR SLEEVE	1	42028
23	SLIP RING 5/8 INCH	2	20020HD
24	HEAD STUD 3 1/2 LG, BRASS	2	42032
25	HEX NUT #10-32 BRASS	6	42301
26	#10 INTERNAL TOOTH WASHER	10	12573
27	STUD INSULATOR 1-3/32 IN	1	42029
28	STUD INSULATOR 5/8"	1	42030
29	STUD INSULATOR 1-3/4"	1	42037
30	SET SCREW 1/4-20 X 3/8	1	74125

Brush Assembly and Motor

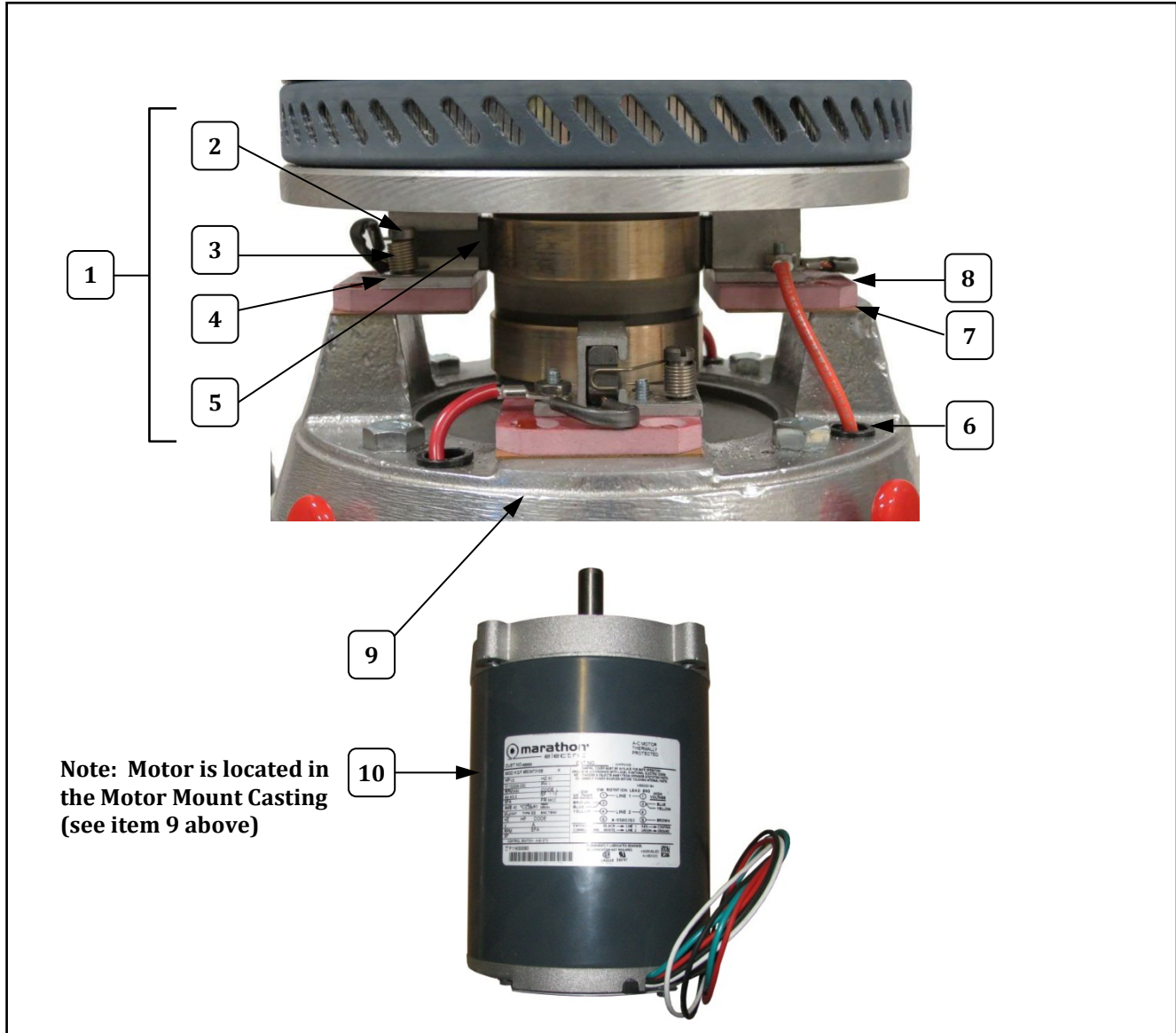

Note: Motor is located in the Motor Mount Casting (see item 9 above)

Item	Part Description	Qty.	Part Number		
			3015A, 3015PE	3015AX	3015AXA
1	BRUSH ASSEMBLY W/BRUSH	4	42320	42320	42320
2	SCREW BRUSH SPRING	4	20052	20052	20052
3	SPRING BRUSH TENSION	4	20033	20033	20033
4	BRUSH HOLDER	4	20032	20032	20032
5	CARBON BRUSH	4	20034	20034	20034
6	BUSHING, SNAP .500 IN	4	47236	47236	47236
7	INSULATOR BRUSH HOLDER	4	48017	48017	48017
8	BRUSH PAD	4	42035	42035	42035
9	MOTOR CASTING	1	42034	42034	42034
10	MOTOR, 1/3 HP 115VAC	1	48669		
	MOTOR, 1/3 HP 230VAC	1		48669EX	48669EX

Unit Interior – Model 3015A, 3015PE (Domestic)

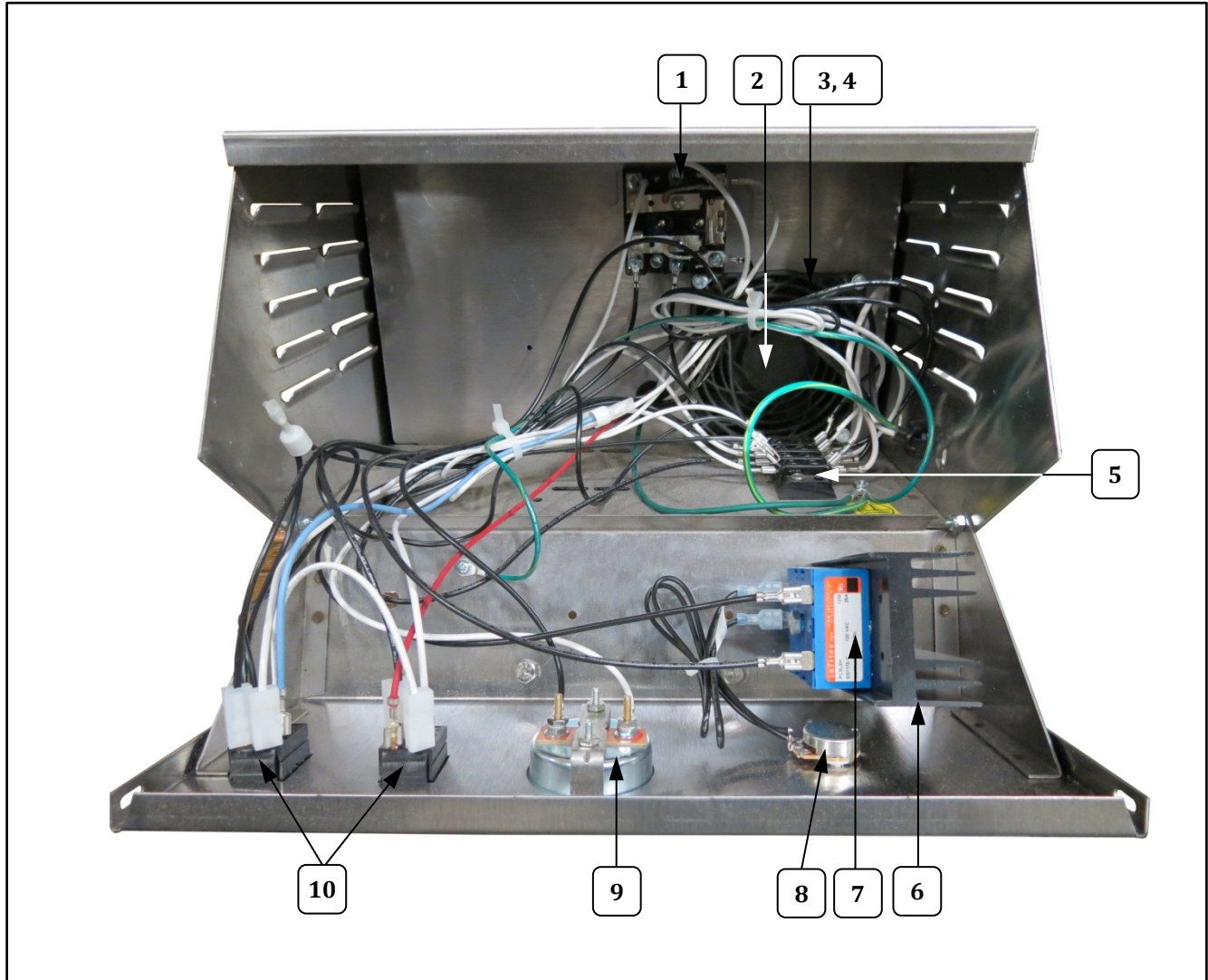

Item	Part Description	Qty.	Part No.
			3015A, 3015PE
1	RELAY, 30A DPST 120V	1	55219
2	FINGER GUARD	1	47200
3	EXHAUST BLOWER 120V,60CY	1	48018
4	BLOWER PLUG AND CORD	1	47199
5	TERMINAL BLOCK	1	42006
6	HEAT SINK	1	48673
7	PHASE CONTROL	1	48675
8	POTENTIOMETER 1K	1	48674
9	VOLTMETER	1	42411
10	SWITCH, LIGHTED ROCKER GR	2	42798

Unit Interior – Model 3015AX, 3015AXA (Export)

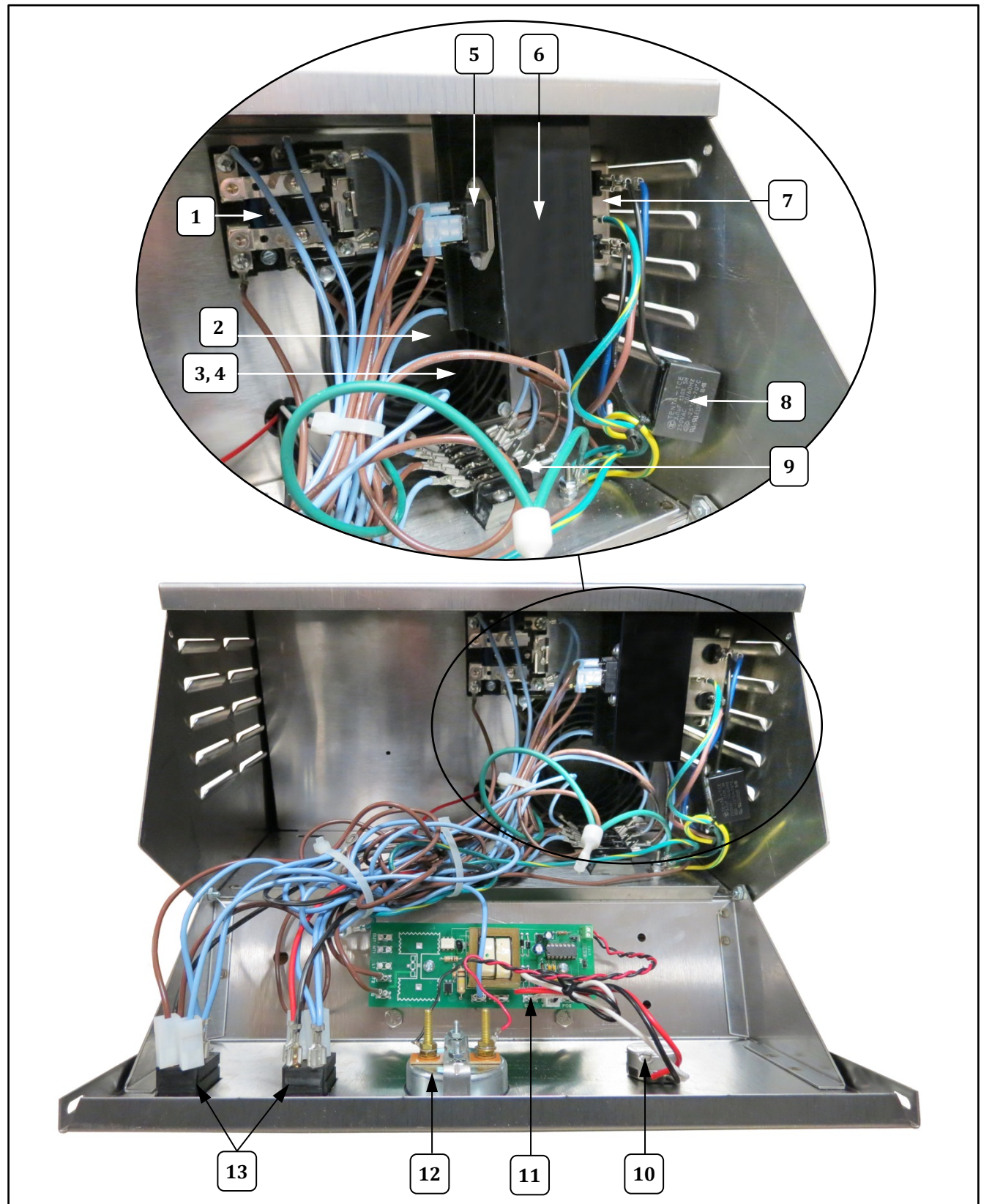

Parts List Unit Interior – Model 3015AX, 3015AXA (Export)

Item	Part Description	Qty.	Part Number	
			3015AX	3015AXA
1	RELAY, 30A DPST 240V	1	55219EX	55219EX
2	FINGER GUARD	1	47200	47200
3	EXHAUST BLOWER 220V, 50CY	1	48037	48037
4	BLOWER PLUG AND CORD	1	47199	47199
5	TRIAC, 35A 600V	1	55155	55155
6	HEAT SINK	1	48673	48673
7	FILTER EMI 20 AMP	1	48695	48695
8	3uF 250VAC CAPACITOR	1	55527	55527
9	TERMINAL BLOCK	1	42006	42006
10	POTENTIOMETER 1K	1	55263	55263
11	HEAT CONTROL EXPORT	1	55342A	55342A
12	VOLT METER	1	55470A	55470A
13	SWITCH, LIGHTED ROCKER GR	2	42798	42798

Floss Pan and Whirlgrip Stabilizer

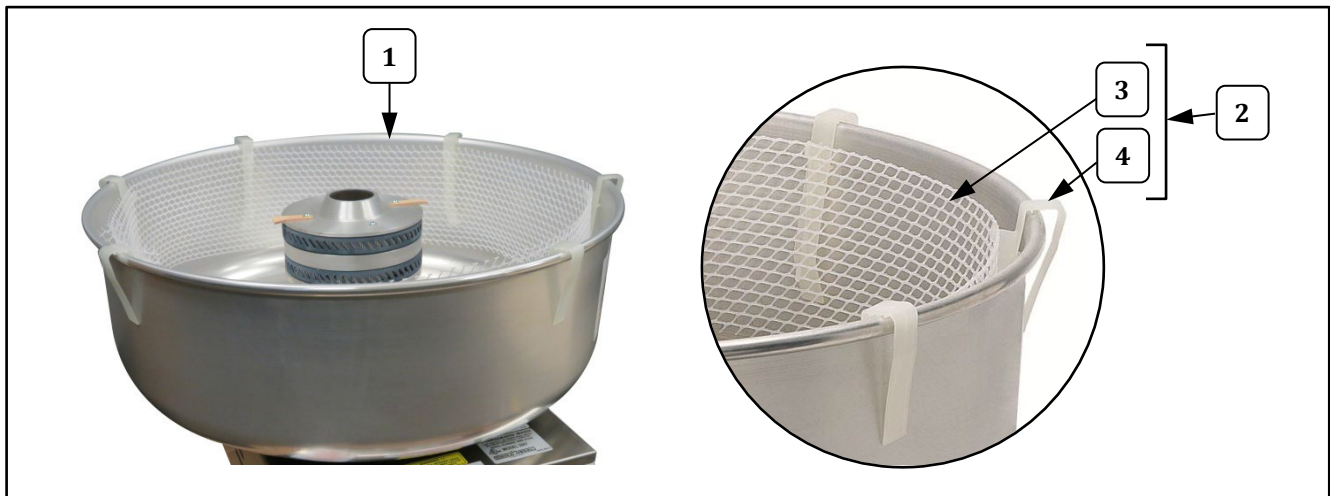

Item	Part Description	Qty.	Part Number		
			3015A, 3015PE	3015AX	3015AXA
1	FLOSS PAN	1	42040	42040	42040
2	WHIRLGRIP STABILIZER (Includes Floss Stabilizer and Clips)	1	3010	3010	3010
3	FLOSS STABILIZER (Web)	1	43032	43032	43032
4	WHIRLGRIP CLIPS	6	77470	77470	77470



WIRING DIAGRAMS

Model No. 3015A and 3015PE

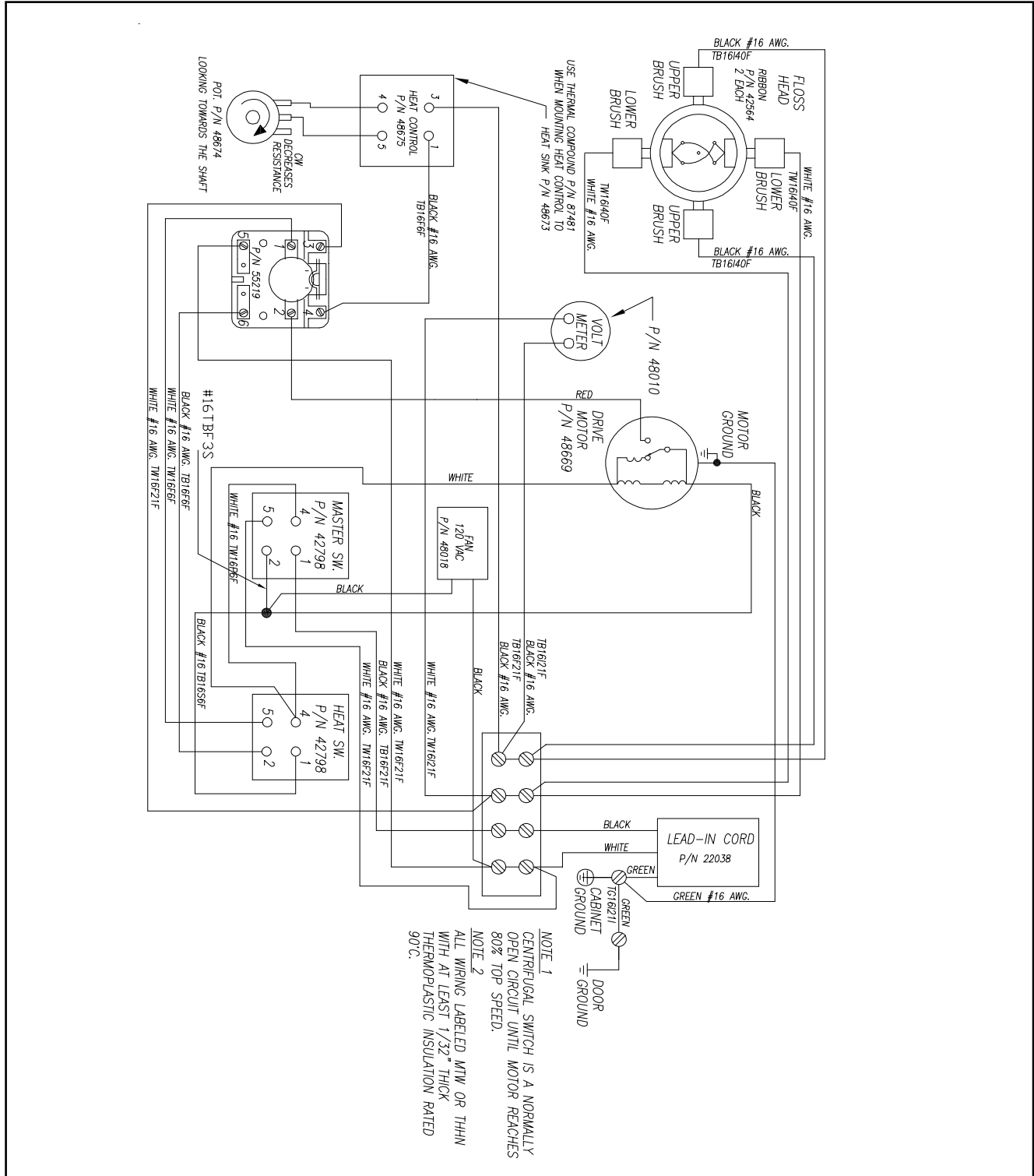



Model No. 3015AX, 3015AXA (Export)

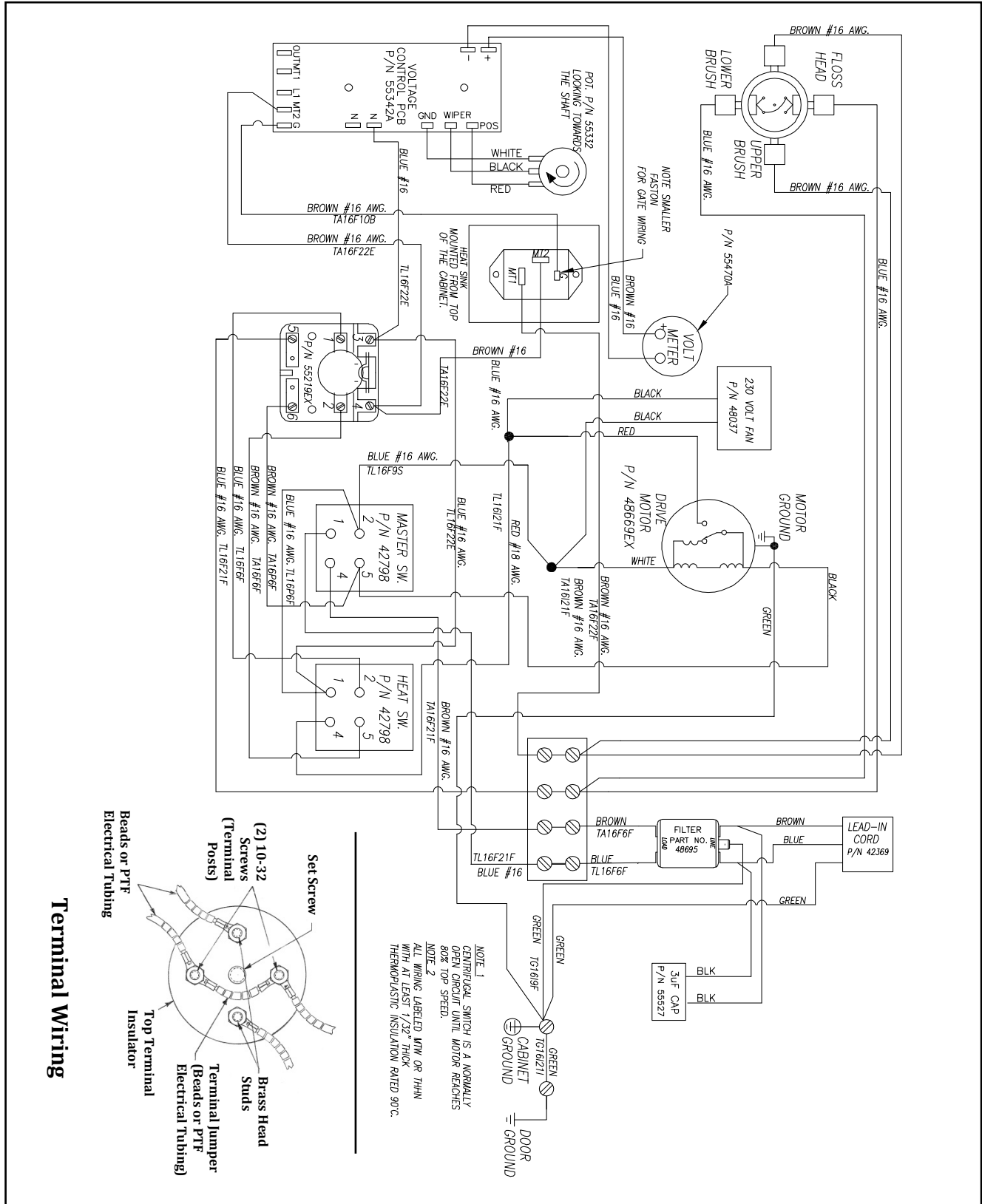



WARRANTY

Gold Medal Products Co. warrants to the original purchaser each item of its manufacture to be free of defects in workmanship and material under normal use and service. Gold Medal Products Co.'s obligation under this warranty is limited solely to repairing or replacing parts, f.o.b. Cincinnati, Ohio, which in its judgment are defective in workmanship or material and which are returned, freight prepaid, to its Cincinnati, Ohio factory or other designated point. Except for "Perishable Parts" on specific machines, the above warranty applies for a period of two (2) years from the date of original sale to the original purchaser of equipment when recommended operating instructions and maintenance procedures have been followed. These are packed with the machine. Parts warranty is two (2) years, labor is six (6) months.

THIS WARRANTY IS IN LIEU OF ALL OTHER WARRANTIES EXPRESSED OR IMPLIED, AND OF ALL OTHER OBLIGATIONS OR LIABILITIES ON OUR PART, INCLUDING THE IMPLIED WARRANTY OF MERCHANTABILITY. THERE ARE NO WARRANTIES WHICH EXTEND BEYOND THE DESCRIPTION ON THE FACE HEREOF. In no event shall Gold Medal Products Co. be liable for special, incidental or consequential damages. No claim under this warranty will be honored if the equipment covered has been misused, neglected, damaged in transit, or has been tampered with or changed in any way. No claim under this warranty shall be honored in the event that components in the unit at the time of the claim were not supplied or approved by Gold Medal Products Co. This warranty is effective only when electrical items have been properly attached to city utility lines only at proper voltages. This warranty is not transferable without the written consent of Gold Medal Products Co.

The term "Original Purchaser" as used in this warranty shall be deemed to mean that person, firm, association, or corporation who was billed by the GOLD MEDAL PRODUCTS CO., or their authorized distributor for the equipment.

THIS WARRANTY HAS NO EFFECT AND IS VOID UNLESS THE ORIGINAL PURCHASER FIRST CALLS GOLD MEDAL PRODUCTS CO. AT 1-800-543-0862 TO DISCUSS WITH OUR SERVICE REPRESENTATIVE THE EQUIPMENT PROBLEM, AND, IF NECESSARY, FOR INSTRUCTIONS CONCERNING THE REPAIR OR REPLACEMENT OF PARTS.

NOTE: This equipment is manufactured and sold for commercial use only.



GOLD MEDAL PRODUCTS CO.

10700 Medallion Drive, Cincinnati, Ohio 45241-4807 USA

gmpopcorn.com

Phone: (800) 543-0862 Fax: (800) 542-1496
(513) 769-7676 (513) 769-8500