

# INSTALLATION INSTRUCTIONS

## Inspection of Shipment

After unpacking, check thoroughly for any damage which may have occurred in transit. Claims should be filed immediately with the transportation company. The warranty does not cover damage that occurs in transit, or damage caused by abuse, or consequential damage due to the operation of this machine, since it is beyond our control (reference warranty in back of manual).

## Manual

Read and understand the operator's manual and all other safety instructions before using this equipment. To order copies of the operator's manual go to [gmpopcorn.com](http://gmpopcorn.com) or write to Gold Medal Products Co., 10700 Medallion Drive, Cincinnati, OH 45241 USA 1-(800)-543-0862.

## Model Description

**3017-00-000:** Econo Floss cotton candy machine with aluminum floss pan, Whirlgrip Stabilizer and 6 clips.

**3024-00-000:** Floss Boss cotton candy machine with non-metal floss pan, Whirlgrip Stabilizer and 5 clips.

## Items Included with this Unit

**Whirlgrip Floss Stabilizer**  
Model 3017 (PN 3010)  
Model 3024 (PN 3010NM)

**Aluminum Floss Pan**  
Model 3017 (PN 42040)

**Non-Metal Floss Pan**  
Model 3024 (PN 42040NMR)

**Instruction Manual**

**Registration Warranty Card**

**Cotton Candy Cone Samples**  
(PN 3021M/case of 1000)

# INSTALLATION INSTRUCTIONS

## Inspection of Shipment

After unpacking, check thoroughly for any damage which may have occurred in transit. Claims should be filed immediately with the transportation company. The warranty does not cover damage that occurs in transit, or damage caused by abuse, or consequential damage due to the operation of this machine, since it is beyond our control (reference warranty in back of manual).

## Manual

Read and understand the operator's manual and all other safety instructions before using this equipment. To order copies of the operator's manual go to [gmpopcorn.com](http://gmpopcorn.com) or write to Gold Medal Products Co., 10700 Medallion Drive, Cincinnati, OH 45241 USA 1-(800)-543-0862.

## Model Description

**3017-00-000:** Econo Floss cotton candy machine with aluminum floss pan, Whirlgrip Stabilizer and 6 clips.

**3024-00-000:** Floss Boss cotton candy machine with non-metal floss pan, Whirlgrip Stabilizer and 5 clips.

## Items Included with this Unit

**Whirlgrip Floss Stabilizer**  
Model 3017 (PN 3010)  
Model 3024 (PN 3010NM)

**Aluminum Floss Pan**  
Model 3017 (PN 42040)

**Non-Metal Floss Pan**  
Model 3024 (PN 42040NMR)

**Instruction Manual**

**Registration Warranty Card**

**Cotton Candy Cone Samples**  
(PN 3021M/case of 1000)

# Whirlgrip Floss Stabilizer

## Installation Instructions

Unit must be OFF, and cool to install Floss Stabilizer. Place Floss Pan on unit and install Whirl Grip Floss Stabilizer (Item No. 3010) as shown below. Kit includes: Floss Stabilizer/screening (P/N 43032), and (6) Whirlgrip Clips (P/N 77470). Clips are designed to provide air space between screening and floss pan.

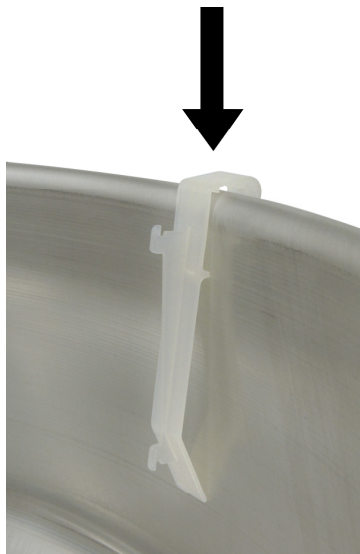

**Step 1:** Place Whirl Clips over rim of pan with hooks facing inside.

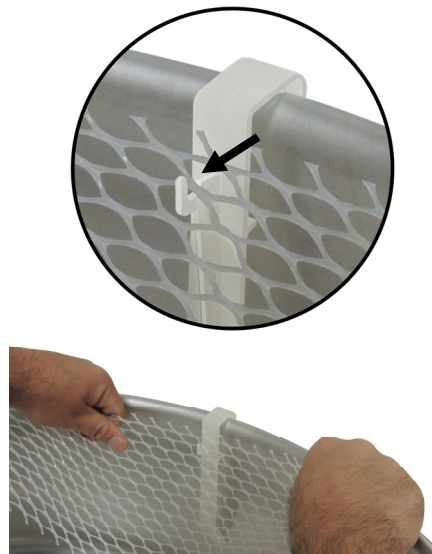

**Step 2:** Hang Stabilizer on top, up facing hook. Screening should be about flush with top of pan.

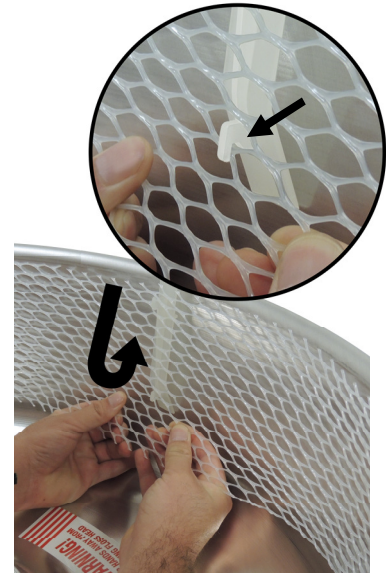

**Step 3:** Gently pull screening down and attach to bottom, down facing hook.

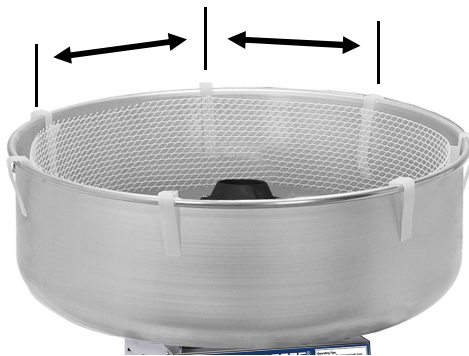

Allow **air space** for proper operation.

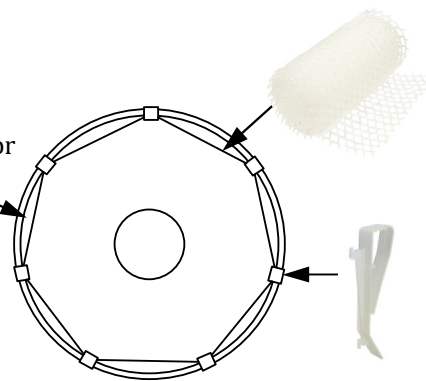

**Top View of Floss Pan**

**Step 4:** Repeat for all clips keeping equal spacing around pan (number of clips varies by model). Allow air space between pan and screening for proper operation.

# Whirlgrip Floss Stabilizer

## Installation Instructions

Unit must be OFF, and cool to install Floss Stabilizer. Place Floss Pan on unit and install Whirl Grip Floss Stabilizer (Item No. 3010) as shown below. Kit includes: Floss Stabilizer/screening (P/N 43032), and (6) Whirlgrip Clips (P/N 77470). Clips are designed to provide air space between screening and floss pan.

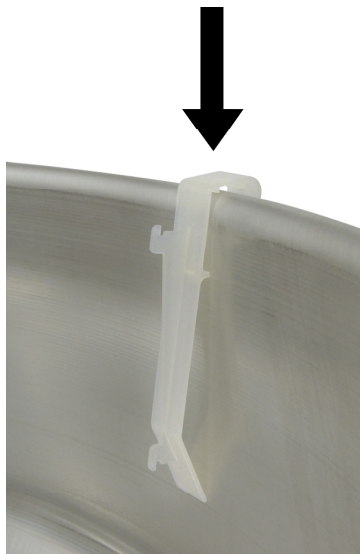

**Step 1:** Place Whirl Clips over rim of pan with hooks facing inside.

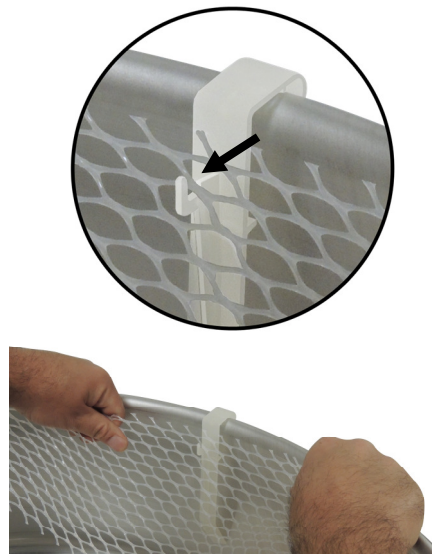

**Step 2:** Hang Stabilizer on top, up facing hook. Screening should be about flush with top of pan.

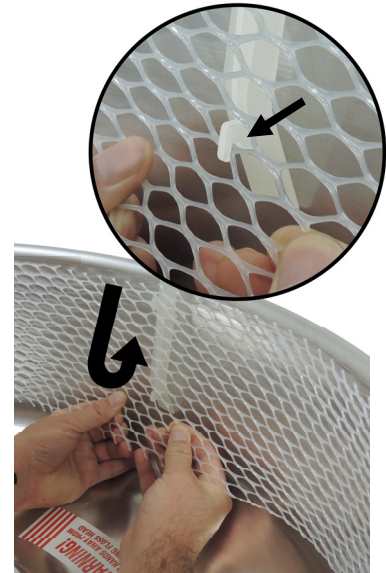

**Step 3:** Gently pull screening down and attach to bottom, down facing hook.

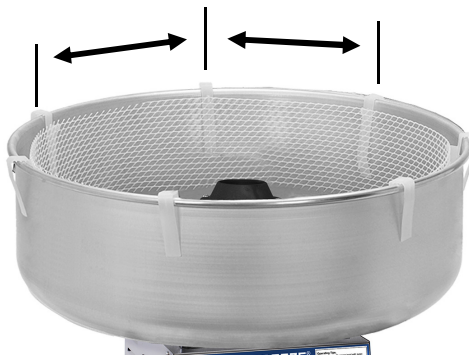

Allow **air space** for proper operation.

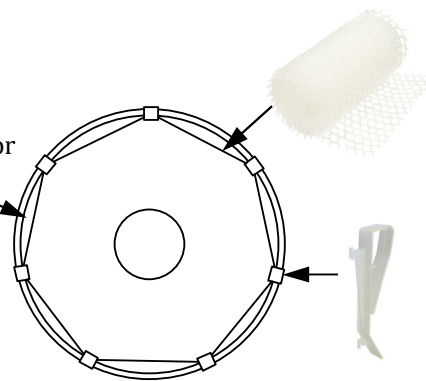

**Top View of Floss Pan**

**Step 4:** Repeat for all clips keeping equal spacing around pan (number of clips varies by model). Allow air space between pan and screening for proper operation.



## Cabinet Exterior and Lock-N-Go Handle Assembly – Parts List

Item	Part Description	Part Number	
		3017-00-000	3024-00-000
1	SPINNER HEAD, COMPLETE 5IN (Complete Assy.) See Spinner Head Assembly section for individual parts breakdown.	42283	42283
2	BRUSH HOLDER ASSY (includes Brushes, Caps and Holders) See Brush Assembly Breakdown section for individual parts breakdown.	42382W	42382W
3	BELL HOUSING, DUAL BRUSH	42190	42190
4	LABEL,FLOSS ADVERTISEMENT	42159	42159
5	BOWL, SEAL RETAINER	56561	56561
6	BELL HOUSING SEAL	56571	56571
7	THREADED BUMPER,1/4-20	102017	102017
8	NAME,INSTRUCTION OVERLAY	102027	102023
9	SWITCH, LIGHTED ROCKER GR	42798	42798
10	KNOB, HEAT CONTROL	42556	42556
11	RUBBER FEET 3/4IN HIGH (4 required)	47155	47155
12	LOCK N GO HANDLE, NEW CAB.	56563	56563
13	5/16-18 X 1/2 PH TR M/S	12183	12183
14	WASHER SS .5 ID X 1.10 OD	48428	48428
15	CLAMPING SHAFT, LOCK N GO	56565	56565
16	CLAMPING CAM	42460	42460
17	5/16 FLAT WASHER ZINC PLT	74134	74134
18	HEX NUT 5/16-18 ESLOK	12001	12001
19*	POWER SUPPLY CORD	22038	22038
20	STRAIN RELIEF SR-6P3-4	76026	76026
21	WARNING LABEL CORD	68720	68720
22	8-32 X 3/8 PHIL PAN HEAD	87515	87515
23	1/4-20 X 3/4 GRADE 5 BOLT (w/Lock Washer)	74520	74520
24	TINNERMAN NUT 1/4-20	42125	42125
25	8-32 X 3/8 SLT. HWH M/S	42044	42044
26	#8-32 TINNERMAN FASTENER	47299	47299
27	INSPECTION BRUSH COVER	42381	42381
28	LABEL,CLEAN EVERY 500 LBS	42002	42002



## Cabinet Exterior and Lock-N-Go Handle Assembly – Parts List

Item	Part Description	Part Number	
		3017-00-000	3024-00-000
1	SPINNER HEAD, COMPLETE 5IN (Complete Assy.) See Spinner Head Assembly section for individual parts breakdown.	42283	42283
2	BRUSH HOLDER ASSY (includes Brushes, Caps and Holders) See Brush Assembly Breakdown section for individual parts breakdown.	42382W	42382W
3	BELL HOUSING, DUAL BRUSH	42190	42190
4	LABEL,FLOSS ADVERTISEMENT	42159	42159
5	BOWL, SEAL RETAINER	56561	56561
6	BELL HOUSING SEAL	56571	56571
7	THREADED BUMPER,1/4-20	102017	102017
8	NAME,INSTRUCTION OVERLAY	102027	102023
9	SWITCH, LIGHTED ROCKER GR	42798	42798
10	KNOB, HEAT CONTROL	42556	42556
11	RUBBER FEET 3/4IN HIGH (4 required)	47155	47155
12	LOCK N GO HANDLE, NEW CAB.	56563	56563
13	5/16-18 X 1/2 PH TR M/S	12183	12183
14	WASHER SS .5 ID X 1.10 OD	48428	48428
15	CLAMPING SHAFT, LOCK N GO	56565	56565
16	CLAMPING CAM	42460	42460
17	5/16 FLAT WASHER ZINC PLT	74134	74134
18	HEX NUT 5/16-18 ESLOK	12001	12001
19*	POWER SUPPLY CORD	22038	22038
20	STRAIN RELIEF SR-6P3-4	76026	76026
21	WARNING LABEL CORD	68720	68720
22	8-32 X 3/8 PHIL PAN HEAD	87515	87515
23	1/4-20 X 3/4 GRADE 5 BOLT (w/Lock Washer)	74520	74520
24	TINNERMAN NUT 1/4-20	42125	42125
25	8-32 X 3/8 SLT. HWH M/S	42044	42044
26	#8-32 TINNERMAN FASTENER	47299	47299
27	INSPECTION BRUSH COVER	42381	42381
28	LABEL,CLEAN EVERY 500 LBS	42002	42002



## Cabinet Exterior and Lock-N-Go Handle Assembly – Parts List

Item	Part Description	Part Number	
		3017-00-000	3024-00-000
1	SPINNER HEAD, COMPLETE 5IN (Complete Assy.) See Spinner Head Assembly section for individual parts breakdown.	42283	42283
2	BRUSH HOLDER ASSY (includes Brushes, Caps and Holders) See Brush Assembly Breakdown section for individual parts breakdown.	42382W	42382W
3	BELL HOUSING, DUAL BRUSH	42190	42190
4	LABEL,FLOSS ADVERTISEMENT	42159	42159
5	BOWL, SEAL RETAINER	56561	56561
6	BELL HOUSING SEAL	56571	56571
7	THREADED BUMPER,1/4-20	102017	102017
8	NAME,INSTRUCTION OVERLAY	102027	102023
9	SWITCH, LIGHTED ROCKER GR	42798	42798
10	KNOB, HEAT CONTROL	42556	42556
11	RUBBER FEET 3/4IN HIGH (4 required)	47155	47155
12	LOCK N GO HANDLE, NEW CAB.	56563	56563
13	5/16-18 X 1/2 PH TR M/S	12183	12183
14	WASHER SS .5 ID X 1.10 OD	48428	48428
15	CLAMPING SHAFT, LOCK N GO	56565	56565
16	CLAMPING CAM	42460	42460
17	5/16 FLAT WASHER ZINC PLT	74134	74134
18	HEX NUT 5/16-18 ESLOK	12001	12001
19*	POWER SUPPLY CORD	22038	22038
20	STRAIN RELIEF SR-6P3-4	76026	76026
21	WARNING LABEL CORD	68720	68720
22	8-32 X 3/8 PHIL PAN HEAD	87515	87515
23	1/4-20 X 3/4 GRADE 5 BOLT (w/Lock Washer)	74520	74520
24	TINNERMAN NUT 1/4-20	42125	42125
25	8-32 X 3/8 SLT. HWH M/S	42044	42044
26	#8-32 TINNERMAN FASTENER	47299	47299
27	INSPECTION BRUSH COVER	42381	42381
28	LABEL,CLEAN EVERY 500 LBS	42002	42002



## Cabinet Exterior and Lock-N-Go Handle Assembly – Parts List

Item	Part Description	Part Number	
		3017-00-000	3024-00-000
1	SPINNER HEAD, COMPLETE 5IN (Complete Assy.) See Spinner Head Assembly section for individual parts breakdown.	42283	42283
2	BRUSH HOLDER ASSY (includes Brushes, Caps and Holders) See Brush Assembly Breakdown section for individual parts breakdown.	42382W	42382W
3	BELL HOUSING, DUAL BRUSH	42190	42190
4	LABEL,FLOSS ADVERTISEMENT	42159	42159
5	BOWL, SEAL RETAINER	56561	56561
6	BELL HOUSING SEAL	56571	56571
7	THREADED BUMPER,1/4-20	102017	102017
8	NAME,INSTRUCTION OVERLAY	102027	102023
9	SWITCH, LIGHTED ROCKER GR	42798	42798
10	KNOB, HEAT CONTROL	42556	42556
11	RUBBER FEET 3/4IN HIGH (4 required)	47155	47155
12	LOCK N GO HANDLE, NEW CAB.	56563	56563
13	5/16-18 X 1/2 PH TR M/S	12183	12183
14	WASHER SS .5 ID X 1.10 OD	48428	48428
15	CLAMPING SHAFT, LOCK N GO	56565	56565
16	CLAMPING CAM	42460	42460
17	5/16 FLAT WASHER ZINC PLT	74134	74134
18	HEX NUT 5/16-18 ESLOK	12001	12001
19*	POWER SUPPLY CORD	22038	22038
20	STRAIN RELIEF SR-6P3-4	76026	76026
21	WARNING LABEL CORD	68720	68720
22	8-32 X 3/8 PHIL PAN HEAD	87515	87515
23	1/4-20 X 3/4 GRADE 5 BOLT (w/Lock Washer)	74520	74520
24	TINNERMAN NUT 1/4-20	42125	42125
25	8-32 X 3/8 SLT. HWH M/S	42044	42044
26	#8-32 TINNERMAN FASTENER	47299	47299
27	INSPECTION BRUSH COVER	42381	42381
28	LABEL,CLEAN EVERY 500 LBS	42002	42002



## Cabinet Exterior and Lock-N-Go Handle Assembly – Parts List

Item	Part Description	Part Number	
		3017-00-000	3024-00-000
1	SPINNER HEAD, COMPLETE 5IN (Complete Assy.) See Spinner Head Assembly section for individual parts breakdown.	42283	42283
2	BRUSH HOLDER ASSY (includes Brushes, Caps and Holders) See Brush Assembly Breakdown section for individual parts breakdown.	42382W	42382W
3	BELL HOUSING, DUAL BRUSH	42190	42190
4	LABEL,FLOSS ADVERTISEMENT	42159	42159
5	BOWL, SEAL RETAINER	56561	56561
6	BELL HOUSING SEAL	56571	56571
7	THREADED BUMPER,1/4-20	102017	102017
8	NAME,INSTRUCTION OVERLAY	102027	102023
9	SWITCH, LIGHTED ROCKER GR	42798	42798
10	KNOB, HEAT CONTROL	42556	42556
11	RUBBER FEET 3/4IN HIGH (4 required)	47155	47155
12	LOCK N GO HANDLE, NEW CAB.	56563	56563
13	5/16-18 X 1/2 PH TR M/S	12183	12183
14	WASHER SS .5 ID X 1.10 OD	48428	48428
15	CLAMPING SHAFT, LOCK N GO	56565	56565
16	CLAMPING CAM	42460	42460
17	5/16 FLAT WASHER ZINC PLT	74134	74134
18	HEX NUT 5/16-18 ESLOK	12001	12001
19*	POWER SUPPLY CORD	22038	22038
20	STRAIN RELIEF SR-6P3-4	76026	76026
21	WARNING LABEL CORD	68720	68720
22	8-32 X 3/8 PHIL PAN HEAD	87515	87515
23	1/4-20 X 3/4 GRADE 5 BOLT (w/Lock Washer)	74520	74520
24	TINNERMAN NUT 1/4-20	42125	42125
25	8-32 X 3/8 SLT. HWH M/S	42044	42044
26	#8-32 TINNERMAN FASTENER	47299	47299
27	INSPECTION BRUSH COVER	42381	42381
28	LABEL,CLEAN EVERY 500 LBS	42002	42002



## Cabinet Exterior and Lock-N-Go Handle Assembly – Parts List

Item	Part Description	Part Number	
		3017-00-000	3024-00-000
1	SPINNER HEAD, COMPLETE 5IN (Complete Assy.) See Spinner Head Assembly section for individual parts breakdown.	42283	42283
2	BRUSH HOLDER ASSY (includes Brushes, Caps and Holders) See Brush Assembly Breakdown section for individual parts breakdown.	42382W	42382W
3	BELL HOUSING, DUAL BRUSH	42190	42190
4	LABEL,FLOSS ADVERTISEMENT	42159	42159
5	BOWL, SEAL RETAINER	56561	56561
6	BELL HOUSING SEAL	56571	56571
7	THREADED BUMPER,1/4-20	102017	102017
8	NAME,INSTRUCTION OVERLAY	102027	102023
9	SWITCH, LIGHTED ROCKER GR	42798	42798
10	KNOB, HEAT CONTROL	42556	42556
11	RUBBER FEET 3/4IN HIGH (4 required)	47155	47155
12	LOCK N GO HANDLE, NEW CAB.	56563	56563
13	5/16-18 X 1/2 PH TR M/S	12183	12183
14	WASHER SS .5 ID X 1.10 OD	48428	48428
15	CLAMPING SHAFT, LOCK N GO	56565	56565
16	CLAMPING CAM	42460	42460
17	5/16 FLAT WASHER ZINC PLT	74134	74134
18	HEX NUT 5/16-18 ESLOK	12001	12001
19*	POWER SUPPLY CORD	22038	22038
20	STRAIN RELIEF SR-6P3-4	76026	76026
21	WARNING LABEL CORD	68720	68720
22	8-32 X 3/8 PHIL PAN HEAD	87515	87515
23	1/4-20 X 3/4 GRADE 5 BOLT (w/Lock Washer)	74520	74520
24	TINNERMAN NUT 1/4-20	42125	42125
25	8-32 X 3/8 SLT. HWH M/S	42044	42044
26	#8-32 TINNERMAN FASTENER	47299	47299
27	INSPECTION BRUSH COVER	42381	42381
28	LABEL,CLEAN EVERY 500 LBS	42002	42002



## Cabinet Exterior and Lock-N-Go Handle Assembly – Parts List

Item	Part Description	Part Number	
		3017-00-000	3024-00-000
1	SPINNER HEAD, COMPLETE 5IN (Complete Assy.) See Spinner Head Assembly section for individual parts breakdown.	42283	42283
2	BRUSH HOLDER ASSY (includes Brushes, Caps and Holders) See Brush Assembly Breakdown section for individual parts breakdown.	42382W	42382W
3	BELL HOUSING, DUAL BRUSH	42190	42190
4	LABEL,FLOSS ADVERTISEMENT	42159	42159
5	BOWL, SEAL RETAINER	56561	56561
6	BELL HOUSING SEAL	56571	56571
7	THREADED BUMPER,1/4-20	102017	102017
8	NAME,INSTRUCTION OVERLAY	102027	102023
9	SWITCH, LIGHTED ROCKER GR	42798	42798
10	KNOB, HEAT CONTROL	42556	42556
11	RUBBER FEET 3/4IN HIGH (4 required)	47155	47155
12	LOCK N GO HANDLE, NEW CAB.	56563	56563
13	5/16-18 X 1/2 PH TR M/S	12183	12183
14	WASHER SS .5 ID X 1.10 OD	48428	48428
15	CLAMPING SHAFT, LOCK N GO	56565	56565
16	CLAMPING CAM	42460	42460
17	5/16 FLAT WASHER ZINC PLT	74134	74134
18	HEX NUT 5/16-18 ESLOK	12001	12001
19*	POWER SUPPLY CORD	22038	22038
20	STRAIN RELIEF SR-6P3-4	76026	76026
21	WARNING LABEL CORD	68720	68720
22	8-32 X 3/8 PHIL PAN HEAD	87515	87515
23	1/4-20 X 3/4 GRADE 5 BOLT (w/Lock Washer)	74520	74520
24	TINNERMAN NUT 1/4-20	42125	42125
25	8-32 X 3/8 SLT. HWH M/S	42044	42044
26	#8-32 TINNERMAN FASTENER	47299	47299
27	INSPECTION BRUSH COVER	42381	42381
28	LABEL,CLEAN EVERY 500 LBS	42002	42002



## Cabinet Exterior and Lock-N-Go Handle Assembly – Parts List

Item	Part Description	Part Number	
		3017-00-000	3024-00-000
1	SPINNER HEAD, COMPLETE 5IN (Complete Assy.) See Spinner Head Assembly section for individual parts breakdown.	42283	42283
2	BRUSH HOLDER ASSY (includes Brushes, Caps and Holders) See Brush Assembly Breakdown section for individual parts breakdown.	42382W	42382W
3	BELL HOUSING, DUAL BRUSH	42190	42190
4	LABEL,FLOSS ADVERTISEMENT	42159	42159
5	BOWL, SEAL RETAINER	56561	56561
6	BELL HOUSING SEAL	56571	56571
7	THREADED BUMPER,1/4-20	102017	102017
8	NAME,INSTRUCTION OVERLAY	102027	102023
9	SWITCH, LIGHTED ROCKER GR	42798	42798
10	KNOB, HEAT CONTROL	42556	42556
11	RUBBER FEET 3/4IN HIGH (4 required)	47155	47155
12	LOCK N GO HANDLE, NEW CAB.	56563	56563
13	5/16-18 X 1/2 PH TR M/S	12183	12183
14	WASHER SS .5 ID X 1.10 OD	48428	48428
15	CLAMPING SHAFT, LOCK N GO	56565	56565
16	CLAMPING CAM	42460	42460
17	5/16 FLAT WASHER ZINC PLT	74134	74134
18	HEX NUT 5/16-18 ESLOK	12001	12001
19*	POWER SUPPLY CORD	22038	22038
20	STRAIN RELIEF SR-6P3-4	76026	76026
21	WARNING LABEL CORD	68720	68720
22	8-32 X 3/8 PHIL PAN HEAD	87515	87515
23	1/4-20 X 3/4 GRADE 5 BOLT (w/Lock Washer)	74520	74520
24	TINNERMAN NUT 1/4-20	42125	42125
25	8-32 X 3/8 SLT. HWH M/S	42044	42044
26	#8-32 TINNERMAN FASTENER	47299	47299
27	INSPECTION BRUSH COVER	42381	42381
28	LABEL,CLEAN EVERY 500 LBS	42002	42002



## Cabinet Exterior and Lock-N-Go Handle Assembly – Parts List

Item	Part Description	Part Number	
		3017-00-000	3024-00-000
1	SPINNER HEAD, COMPLETE 5IN (Complete Assy.) See Spinner Head Assembly section for individual parts breakdown.	42283	42283
2	BRUSH HOLDER ASSY (includes Brushes, Caps and Holders) See Brush Assembly Breakdown section for individual parts breakdown.	42382W	42382W
3	BELL HOUSING, DUAL BRUSH	42190	42190
4	LABEL,FLOSS ADVERTISEMENT	42159	42159
5	BOWL, SEAL RETAINER	56561	56561
6	BELL HOUSING SEAL	56571	56571
7	THREADED BUMPER,1/4-20	102017	102017
8	NAME,INSTRUCTION OVERLAY	102027	102023
9	SWITCH, LIGHTED ROCKER GR	42798	42798
10	KNOB, HEAT CONTROL	42556	42556
11	RUBBER FEET 3/4IN HIGH (4 required)	47155	47155
12	LOCK N GO HANDLE, NEW CAB.	56563	56563
13	5/16-18 X 1/2 PH TR M/S	12183	12183
14	WASHER SS .5 ID X 1.10 OD	48428	48428
15	CLAMPING SHAFT, LOCK N GO	56565	56565
16	CLAMPING CAM	42460	42460
17	5/16 FLAT WASHER ZINC PLT	74134	74134
18	HEX NUT 5/16-18 ESLOK	12001	12001
19*	POWER SUPPLY CORD	22038	22038
20	STRAIN RELIEF SR-6P3-4	76026	76026
21	WARNING LABEL CORD	68720	68720
22	8-32 X 3/8 PHIL PAN HEAD	87515	87515
23	1/4-20 X 3/4 GRADE 5 BOLT (w/Lock Washer)	74520	74520
24	TINNERMAN NUT 1/4-20	42125	42125
25	8-32 X 3/8 SLT. HWH M/S	42044	42044
26	#8-32 TINNERMAN FASTENER	47299	47299
27	INSPECTION BRUSH COVER	42381	42381
28	LABEL,CLEAN EVERY 500 LBS	42002	42002



## Cabinet Exterior and Lock-N-Go Handle Assembly – Parts List

Item	Part Description	Part Number	
		3017-00-000	3024-00-000
1	SPINNER HEAD, COMPLETE 5IN (Complete Assy.) See Spinner Head Assembly section for individual parts breakdown.	42283	42283
2	BRUSH HOLDER ASSY (includes Brushes, Caps and Holders) See Brush Assembly Breakdown section for individual parts breakdown.	42382W	42382W
3	BELL HOUSING, DUAL BRUSH	42190	42190
4	LABEL,FLOSS ADVERTISEMENT	42159	42159
5	BOWL, SEAL RETAINER	56561	56561
6	BELL HOUSING SEAL	56571	56571
7	THREADED BUMPER,1/4-20	102017	102017
8	NAME,INSTRUCTION OVERLAY	102027	102023
9	SWITCH, LIGHTED ROCKER GR	42798	42798
10	KNOB, HEAT CONTROL	42556	42556
11	RUBBER FEET 3/4IN HIGH (4 required)	47155	47155
12	LOCK N GO HANDLE, NEW CAB.	56563	56563
13	5/16-18 X 1/2 PH TR M/S	12183	12183
14	WASHER SS .5 ID X 1.10 OD	48428	48428
15	CLAMPING SHAFT, LOCK N GO	56565	56565
16	CLAMPING CAM	42460	42460
17	5/16 FLAT WASHER ZINC PLT	74134	74134
18	HEX NUT 5/16-18 ESLOK	12001	12001
19*	POWER SUPPLY CORD	22038	22038
20	STRAIN RELIEF SR-6P3-4	76026	76026
21	WARNING LABEL CORD	68720	68720
22	8-32 X 3/8 PHIL PAN HEAD	87515	87515
23	1/4-20 X 3/4 GRADE 5 BOLT (w/Lock Washer)	74520	74520
24	TINNERMAN NUT 1/4-20	42125	42125
25	8-32 X 3/8 SLT. HWH M/S	42044	42044
26	#8-32 TINNERMAN FASTENER	47299	47299
27	INSPECTION BRUSH COVER	42381	42381
28	LABEL,CLEAN EVERY 500 LBS	42002	42002



## Cabinet Exterior and Lock-N-Go Handle Assembly – Parts List

Item	Part Description	Part Number	
		3017-00-000	3024-00-000
1	SPINNER HEAD, COMPLETE 5IN (Complete Assy.) See Spinner Head Assembly section for individual parts breakdown.	42283	42283
2	BRUSH HOLDER ASSY (includes Brushes, Caps and Holders) See Brush Assembly Breakdown section for individual parts breakdown.	42382W	42382W
3	BELL HOUSING, DUAL BRUSH	42190	42190
4	LABEL,FLOSS ADVERTISEMENT	42159	42159
5	BOWL, SEAL RETAINER	56561	56561
6	BELL HOUSING SEAL	56571	56571
7	THREADED BUMPER,1/4-20	102017	102017
8	NAME,INSTRUCTION OVERLAY	102027	102023
9	SWITCH, LIGHTED ROCKER GR	42798	42798
10	KNOB, HEAT CONTROL	42556	42556
11	RUBBER FEET 3/4IN HIGH (4 required)	47155	47155
12	LOCK N GO HANDLE, NEW CAB.	56563	56563
13	5/16-18 X 1/2 PH TR M/S	12183	12183
14	WASHER SS .5 ID X 1.10 OD	48428	48428
15	CLAMPING SHAFT, LOCK N GO	56565	56565
16	CLAMPING CAM	42460	42460
17	5/16 FLAT WASHER ZINC PLT	74134	74134
18	HEX NUT 5/16-18 ESLOK	12001	12001
19*	POWER SUPPLY CORD	22038	22038
20	STRAIN RELIEF SR-6P3-4	76026	76026
21	WARNING LABEL CORD	68720	68720
22	8-32 X 3/8 PHIL PAN HEAD	87515	87515
23	1/4-20 X 3/4 GRADE 5 BOLT (w/Lock Washer)	74520	74520
24	TINNERMAN NUT 1/4-20	42125	42125
25	8-32 X 3/8 SLT. HWH M/S	42044	42044
26	#8-32 TINNERMAN FASTENER	47299	47299
27	INSPECTION BRUSH COVER	42381	42381
28	LABEL,CLEAN EVERY 500 LBS	42002	42002



## Cabinet Exterior and Lock-N-Go Handle Assembly – Parts List

Item	Part Description	Part Number	
		3017-00-000	3024-00-000
1	SPINNER HEAD, COMPLETE 5IN (Complete Assy.) See Spinner Head Assembly section for individual parts breakdown.	42283	42283
2	BRUSH HOLDER ASSY (includes Brushes, Caps and Holders) See Brush Assembly Breakdown section for individual parts breakdown.	42382W	42382W
3	BELL HOUSING, DUAL BRUSH	42190	42190
4	LABEL,FLOSS ADVERTISEMENT	42159	42159
5	BOWL, SEAL RETAINER	56561	56561
6	BELL HOUSING SEAL	56571	56571
7	THREADED BUMPER,1/4-20	102017	102017
8	NAME,INSTRUCTION OVERLAY	102027	102023
9	SWITCH, LIGHTED ROCKER GR	42798	42798
10	KNOB, HEAT CONTROL	42556	42556
11	RUBBER FEET 3/4IN HIGH (4 required)	47155	47155
12	LOCK N GO HANDLE, NEW CAB.	56563	56563
13	5/16-18 X 1/2 PH TR M/S	12183	12183
14	WASHER SS .5 ID X 1.10 OD	48428	48428
15	CLAMPING SHAFT, LOCK N GO	56565	56565
16	CLAMPING CAM	42460	42460
17	5/16 FLAT WASHER ZINC PLT	74134	74134
18	HEX NUT 5/16-18 ESLOK	12001	12001
19*	POWER SUPPLY CORD	22038	22038
20	STRAIN RELIEF SR-6P3-4	76026	76026
21	WARNING LABEL CORD	68720	68720
22	8-32 X 3/8 PHIL PAN HEAD	87515	87515
23	1/4-20 X 3/4 GRADE 5 BOLT (w/Lock Washer)	74520	74520
24	TINNERMAN NUT 1/4-20	42125	42125
25	8-32 X 3/8 SLT. HWH M/S	42044	42044
26	#8-32 TINNERMAN FASTENER	47299	47299
27	INSPECTION BRUSH COVER	42381	42381
28	LABEL,CLEAN EVERY 500 LBS	42002	42002



## Cabinet Exterior and Lock-N-Go Handle Assembly – Parts List

Item	Part Description	Part Number	
		3017-00-000	3024-00-000
1	SPINNER HEAD, COMPLETE 5IN (Complete Assy.) See Spinner Head Assembly section for individual parts breakdown.	42283	42283
2	BRUSH HOLDER ASSY (includes Brushes, Caps and Holders) See Brush Assembly Breakdown section for individual parts breakdown.	42382W	42382W
3	BELL HOUSING, DUAL BRUSH	42190	42190
4	LABEL,FLOSS ADVERTISEMENT	42159	42159
5	BOWL, SEAL RETAINER	56561	56561
6	BELL HOUSING SEAL	56571	56571
7	THREADED BUMPER,1/4-20	102017	102017
8	NAME,INSTRUCTION OVERLAY	102027	102023
9	SWITCH, LIGHTED ROCKER GR	42798	42798
10	KNOB, HEAT CONTROL	42556	42556
11	RUBBER FEET 3/4IN HIGH (4 required)	47155	47155
12	LOCK N GO HANDLE, NEW CAB.	56563	56563
13	5/16-18 X 1/2 PH TR M/S	12183	12183
14	WASHER SS .5 ID X 1.10 OD	48428	48428
15	CLAMPING SHAFT, LOCK N GO	56565	56565
16	CLAMPING CAM	42460	42460
17	5/16 FLAT WASHER ZINC PLT	74134	74134
18	HEX NUT 5/16-18 ESLOK	12001	12001
19*	POWER SUPPLY CORD	22038	22038
20	STRAIN RELIEF SR-6P3-4	76026	76026
21	WARNING LABEL CORD	68720	68720
22	8-32 X 3/8 PHIL PAN HEAD	87515	87515
23	1/4-20 X 3/4 GRADE 5 BOLT (w/Lock Washer)	74520	74520
24	TINNERMAN NUT 1/4-20	42125	42125
25	8-32 X 3/8 SLT. HWH M/S	42044	42044
26	#8-32 TINNERMAN FASTENER	47299	47299
27	INSPECTION BRUSH COVER	42381	42381
28	LABEL,CLEAN EVERY 500 LBS	42002	42002



## Cabinet Exterior and Lock-N-Go Handle Assembly – Parts List

Item	Part Description	Part Number	
		3017-00-000	3024-00-000
1	SPINNER HEAD, COMPLETE 5IN (Complete Assy.) See Spinner Head Assembly section for individual parts breakdown.	42283	42283
2	BRUSH HOLDER ASSY (includes Brushes, Caps and Holders) See Brush Assembly Breakdown section for individual parts breakdown.	42382W	42382W
3	BELL HOUSING, DUAL BRUSH	42190	42190
4	LABEL,FLOSS ADVERTISEMENT	42159	42159
5	BOWL, SEAL RETAINER	56561	56561
6	BELL HOUSING SEAL	56571	56571
7	THREADED BUMPER,1/4-20	102017	102017
8	NAME,INSTRUCTION OVERLAY	102027	102023
9	SWITCH, LIGHTED ROCKER GR	42798	42798
10	KNOB, HEAT CONTROL	42556	42556
11	RUBBER FEET 3/4IN HIGH (4 required)	47155	47155
12	LOCK N GO HANDLE, NEW CAB.	56563	56563
13	5/16-18 X 1/2 PH TR M/S	12183	12183
14	WASHER SS .5 ID X 1.10 OD	48428	48428
15	CLAMPING SHAFT, LOCK N GO	56565	56565
16	CLAMPING CAM	42460	42460
17	5/16 FLAT WASHER ZINC PLT	74134	74134
18	HEX NUT 5/16-18 ESLOK	12001	12001
19*	POWER SUPPLY CORD	22038	22038
20	STRAIN RELIEF SR-6P3-4	76026	76026
21	WARNING LABEL CORD	68720	68720
22	8-32 X 3/8 PHIL PAN HEAD	87515	87515
23	1/4-20 X 3/4 GRADE 5 BOLT (w/Lock Washer)	74520	74520
24	TINNERMAN NUT 1/4-20	42125	42125
25	8-32 X 3/8 SLT. HWH M/S	42044	42044
26	#8-32 TINNERMAN FASTENER	47299	47299
27	INSPECTION BRUSH COVER	42381	42381
28	LABEL,CLEAN EVERY 500 LBS	42002	42002



## Cabinet Exterior and Lock-N-Go Handle Assembly – Parts List

Item	Part Description	Part Number	
		3017-00-000	3024-00-000
1	SPINNER HEAD, COMPLETE 5IN (Complete Assy.) See Spinner Head Assembly section for individual parts breakdown.	42283	42283
2	BRUSH HOLDER ASSY (includes Brushes, Caps and Holders) See Brush Assembly Breakdown section for individual parts breakdown.	42382W	42382W
3	BELL HOUSING, DUAL BRUSH	42190	42190
4	LABEL,FLOSS ADVERTISEMENT	42159	42159
5	BOWL, SEAL RETAINER	56561	56561
6	BELL HOUSING SEAL	56571	56571
7	THREADED BUMPER,1/4-20	102017	102017
8	NAME,INSTRUCTION OVERLAY	102027	102023
9	SWITCH, LIGHTED ROCKER GR	42798	42798
10	KNOB, HEAT CONTROL	42556	42556
11	RUBBER FEET 3/4IN HIGH (4 required)	47155	47155
12	LOCK N GO HANDLE, NEW CAB.	56563	56563
13	5/16-18 X 1/2 PH TR M/S	12183	12183
14	WASHER SS .5 ID X 1.10 OD	48428	48428
15	CLAMPING SHAFT, LOCK N GO	56565	56565
16	CLAMPING CAM	42460	42460
17	5/16 FLAT WASHER ZINC PLT	74134	74134
18	HEX NUT 5/16-18 ESLOK	12001	12001
19*	POWER SUPPLY CORD	22038	22038
20	STRAIN RELIEF SR-6P3-4	76026	76026
21	WARNING LABEL CORD	68720	68720
22	8-32 X 3/8 PHIL PAN HEAD	87515	87515
23	1/4-20 X 3/4 GRADE 5 BOLT (w/Lock Washer)	74520	74520
24	TINNERMAN NUT 1/4-20	42125	42125
25	8-32 X 3/8 SLT. HWH M/S	42044	42044
26	#8-32 TINNERMAN FASTENER	47299	47299
27	INSPECTION BRUSH COVER	42381	42381
28	LABEL,CLEAN EVERY 500 LBS	42002	42002



## Cabinet Exterior and Lock-N-Go Handle Assembly – Parts List

Item	Part Description	Part Number	
		3017-00-000	3024-00-000
1	SPINNER HEAD, COMPLETE 5IN (Complete Assy.) See Spinner Head Assembly section for individual parts breakdown.	42283	42283
2	BRUSH HOLDER ASSY (includes Brushes, Caps and Holders) See Brush Assembly Breakdown section for individual parts breakdown.	42382W	42382W
3	BELL HOUSING, DUAL BRUSH	42190	42190
4	LABEL,FLOSS ADVERTISEMENT	42159	42159
5	BOWL, SEAL RETAINER	56561	56561
6	BELL HOUSING SEAL	56571	56571
7	THREADED BUMPER,1/4-20	102017	102017
8	NAME,INSTRUCTION OVERLAY	102027	102023
9	SWITCH, LIGHTED ROCKER GR	42798	42798
10	KNOB, HEAT CONTROL	42556	42556
11	RUBBER FEET 3/4IN HIGH (4 required)	47155	47155
12	LOCK N GO HANDLE, NEW CAB.	56563	56563
13	5/16-18 X 1/2 PH TR M/S	12183	12183
14	WASHER SS .5 ID X 1.10 OD	48428	48428
15	CLAMPING SHAFT, LOCK N GO	56565	56565
16	CLAMPING CAM	42460	42460
17	5/16 FLAT WASHER ZINC PLT	74134	74134
18	HEX NUT 5/16-18 ESLOK	12001	12001
19*	POWER SUPPLY CORD	22038	22038
20	STRAIN RELIEF SR-6P3-4	76026	76026
21	WARNING LABEL CORD	68720	68720
22	8-32 X 3/8 PHIL PAN HEAD	87515	87515
23	1/4-20 X 3/4 GRADE 5 BOLT (w/Lock Washer)	74520	74520
24	TINNERMAN NUT 1/4-20	42125	42125
25	8-32 X 3/8 SLT. HWH M/S	42044	42044
26	#8-32 TINNERMAN FASTENER	47299	47299
27	INSPECTION BRUSH COVER	42381	42381
28	LABEL,CLEAN EVERY 500 LBS	42002	42002



## Cabinet Exterior and Lock-N-Go Handle Assembly – Parts List

Item	Part Description	Part Number	
		3017-00-000	3024-00-000
1	SPINNER HEAD, COMPLETE 5IN (Complete Assy.) See Spinner Head Assembly section for individual parts breakdown.	42283	42283
2	BRUSH HOLDER ASSY (includes Brushes, Caps and Holders) See Brush Assembly Breakdown section for individual parts breakdown.	42382W	42382W
3	BELL HOUSING, DUAL BRUSH	42190	42190
4	LABEL,FLOSS ADVERTISEMENT	42159	42159
5	BOWL, SEAL RETAINER	56561	56561
6	BELL HOUSING SEAL	56571	56571
7	THREADED BUMPER,1/4-20	102017	102017
8	NAME,INSTRUCTION OVERLAY	102027	102023
9	SWITCH, LIGHTED ROCKER GR	42798	42798
10	KNOB, HEAT CONTROL	42556	42556
11	RUBBER FEET 3/4IN HIGH (4 required)	47155	47155
12	LOCK N GO HANDLE, NEW CAB.	56563	56563
13	5/16-18 X 1/2 PH TR M/S	12183	12183
14	WASHER SS .5 ID X 1.10 OD	48428	48428
15	CLAMPING SHAFT, LOCK N GO	56565	56565
16	CLAMPING CAM	42460	42460
17	5/16 FLAT WASHER ZINC PLT	74134	74134
18	HEX NUT 5/16-18 ESLOK	12001	12001
19*	POWER SUPPLY CORD	22038	22038
20	STRAIN RELIEF SR-6P3-4	76026	76026
21	WARNING LABEL CORD	68720	68720
22	8-32 X 3/8 PHIL PAN HEAD	87515	87515
23	1/4-20 X 3/4 GRADE 5 BOLT (w/Lock Washer)	74520	74520
24	TINNERMAN NUT 1/4-20	42125	42125
25	8-32 X 3/8 SLT. HWH M/S	42044	42044
26	#8-32 TINNERMAN FASTENER	47299	47299
27	INSPECTION BRUSH COVER	42381	42381
28	LABEL,CLEAN EVERY 500 LBS	42002	42002



## Cabinet Exterior and Lock-N-Go Handle Assembly – Parts List

Item	Part Description	Part Number	
		3017-00-000	3024-00-000
1	SPINNER HEAD, COMPLETE 5IN (Complete Assy.) See Spinner Head Assembly section for individual parts breakdown.	42283	42283
2	BRUSH HOLDER ASSY (includes Brushes, Caps and Holders) See Brush Assembly Breakdown section for individual parts breakdown.	42382W	42382W
3	BELL HOUSING, DUAL BRUSH	42190	42190
4	LABEL,FLOSS ADVERTISEMENT	42159	42159
5	BOWL, SEAL RETAINER	56561	56561
6	BELL HOUSING SEAL	56571	56571
7	THREADED BUMPER,1/4-20	102017	102017
8	NAME,INSTRUCTION OVERLAY	102027	102023
9	SWITCH, LIGHTED ROCKER GR	42798	42798
10	KNOB, HEAT CONTROL	42556	42556
11	RUBBER FEET 3/4IN HIGH (4 required)	47155	47155
12	LOCK N GO HANDLE, NEW CAB.	56563	56563
13	5/16-18 X 1/2 PH TR M/S	12183	12183
14	WASHER SS .5 ID X 1.10 OD	48428	48428
15	CLAMPING SHAFT, LOCK N GO	56565	56565
16	CLAMPING CAM	42460	42460
17	5/16 FLAT WASHER ZINC PLT	74134	74134
18	HEX NUT 5/16-18 ESLOK	12001	12001
19*	POWER SUPPLY CORD	22038	22038
20	STRAIN RELIEF SR-6P3-4	76026	76026
21	WARNING LABEL CORD	68720	68720
22	8-32 X 3/8 PHIL PAN HEAD	87515	87515
23	1/4-20 X 3/4 GRADE 5 BOLT (w/Lock Washer)	74520	74520
24	TINNERMAN NUT 1/4-20	42125	42125
25	8-32 X 3/8 SLT. HWH M/S	42044	42044
26	#8-32 TINNERMAN FASTENER	47299	47299
27	INSPECTION BRUSH COVER	42381	42381
28	LABEL,CLEAN EVERY 500 LBS	42002	42002



## Cabinet Exterior and Lock-N-Go Handle Assembly – Parts List

Item	Part Description	Part Number	
		3017-00-000	3024-00-000
1	SPINNER HEAD, COMPLETE 5IN (Complete Assy.) See Spinner Head Assembly section for individual parts breakdown.	42283	42283
2	BRUSH HOLDER ASSY (includes Brushes, Caps and Holders) See Brush Assembly Breakdown section for individual parts breakdown.	42382W	42382W
3	BELL HOUSING, DUAL BRUSH	42190	42190
4	LABEL,FLOSS ADVERTISEMENT	42159	42159
5	BOWL, SEAL RETAINER	56561	56561
6	BELL HOUSING SEAL	56571	56571
7	THREADED BUMPER,1/4-20	102017	102017
8	NAME,INSTRUCTION OVERLAY	102027	102023
9	SWITCH, LIGHTED ROCKER GR	42798	42798
10	KNOB, HEAT CONTROL	42556	42556
11	RUBBER FEET 3/4IN HIGH (4 required)	47155	47155
12	LOCK N GO HANDLE, NEW CAB.	56563	56563
13	5/16-18 X 1/2 PH TR M/S	12183	12183
14	WASHER SS .5 ID X 1.10 OD	48428	48428
15	CLAMPING SHAFT, LOCK N GO	56565	56565
16	CLAMPING CAM	42460	42460
17	5/16 FLAT WASHER ZINC PLT	74134	74134
18	HEX NUT 5/16-18 ESLOK	12001	12001
19*	POWER SUPPLY CORD	22038	22038
20	STRAIN RELIEF SR-6P3-4	76026	76026
21	WARNING LABEL CORD	68720	68720
22	8-32 X 3/8 PHIL PAN HEAD	87515	87515
23	1/4-20 X 3/4 GRADE 5 BOLT (w/Lock Washer)	74520	74520
24	TINNERMAN NUT 1/4-20	42125	42125
25	8-32 X 3/8 SLT. HWH M/S	42044	42044
26	#8-32 TINNERMAN FASTENER	47299	47299
27	INSPECTION BRUSH COVER	42381	42381
28	LABEL,CLEAN EVERY 500 LBS	42002	42002



## Cabinet Exterior and Lock-N-Go Handle Assembly – Parts List

Item	Part Description	Part Number	
		3017-00-000	3024-00-000
1	SPINNER HEAD, COMPLETE 5IN (Complete Assy.) See Spinner Head Assembly section for individual parts breakdown.	42283	42283
2	BRUSH HOLDER ASSY (includes Brushes, Caps and Holders) See Brush Assembly Breakdown section for individual parts breakdown.	42382W	42382W
3	BELL HOUSING, DUAL BRUSH	42190	42190
4	LABEL,FLOSS ADVERTISEMENT	42159	42159
5	BOWL, SEAL RETAINER	56561	56561
6	BELL HOUSING SEAL	56571	56571
7	THREADED BUMPER,1/4-20	102017	102017
8	NAME,INSTRUCTION OVERLAY	102027	102023
9	SWITCH, LIGHTED ROCKER GR	42798	42798
10	KNOB, HEAT CONTROL	42556	42556
11	RUBBER FEET 3/4IN HIGH (4 required)	47155	47155
12	LOCK N GO HANDLE, NEW CAB.	56563	56563
13	5/16-18 X 1/2 PH TR M/S	12183	12183
14	WASHER SS .5 ID X 1.10 OD	48428	48428
15	CLAMPING SHAFT, LOCK N GO	56565	56565
16	CLAMPING CAM	42460	42460
17	5/16 FLAT WASHER ZINC PLT	74134	74134
18	HEX NUT 5/16-18 ESLOK	12001	12001
19*	POWER SUPPLY CORD	22038	22038
20	STRAIN RELIEF SR-6P3-4	76026	76026
21	WARNING LABEL CORD	68720	68720
22	8-32 X 3/8 PHIL PAN HEAD	87515	87515
23	1/4-20 X 3/4 GRADE 5 BOLT (w/Lock Washer)	74520	74520
24	TINNERMAN NUT 1/4-20	42125	42125
25	8-32 X 3/8 SLT. HWH M/S	42044	42044
26	#8-32 TINNERMAN FASTENER	47299	47299
27	INSPECTION BRUSH COVER	42381	42381
28	LABEL,CLEAN EVERY 500 LBS	42002	42002



## Cabinet Exterior and Lock-N-Go Handle Assembly – Parts List

Item	Part Description	Part Number	
		3017-00-000	3024-00-000
1	SPINNER HEAD, COMPLETE 5IN (Complete Assy.) See Spinner Head Assembly section for individual parts breakdown.	42283	42283
2	BRUSH HOLDER ASSY (includes Brushes, Caps and Holders) See Brush Assembly Breakdown section for individual parts breakdown.	42382W	42382W
3	BELL HOUSING, DUAL BRUSH	42190	42190
4	LABEL,FLOSS ADVERTISEMENT	42159	42159
5	BOWL, SEAL RETAINER	56561	56561
6	BELL HOUSING SEAL	56571	56571
7	THREADED BUMPER,1/4-20	102017	102017
8	NAME,INSTRUCTION OVERLAY	102027	102023
9	SWITCH, LIGHTED ROCKER GR	42798	42798
10	KNOB, HEAT CONTROL	42556	42556
11	RUBBER FEET 3/4IN HIGH (4 required)	47155	47155
12	LOCK N GO HANDLE, NEW CAB.	56563	56563
13	5/16-18 X 1/2 PH TR M/S	12183	12183
14	WASHER SS .5 ID X 1.10 OD	48428	48428
15	CLAMPING SHAFT, LOCK N GO	56565	56565
16	CLAMPING CAM	42460	42460
17	5/16 FLAT WASHER ZINC PLT	74134	74134
18	HEX NUT 5/16-18 ESLOK	12001	12001
19*	POWER SUPPLY CORD	22038	22038
20	STRAIN RELIEF SR-6P3-4	76026	76026
21	WARNING LABEL CORD	68720	68720
22	8-32 X 3/8 PHIL PAN HEAD	87515	87515
23	1/4-20 X 3/4 GRADE 5 BOLT (w/Lock Washer)	74520	74520
24	TINNERMAN NUT 1/4-20	42125	42125
25	8-32 X 3/8 SLT. HWH M/S	42044	42044
26	#8-32 TINNERMAN FASTENER	47299	47299
27	INSPECTION BRUSH COVER	42381	42381
28	LABEL,CLEAN EVERY 500 LBS	42002	42002



## Cabinet Exterior and Lock-N-Go Handle Assembly – Parts List

Item	Part Description	Part Number	
		3017-00-000	3024-00-000
1	SPINNER HEAD, COMPLETE 5IN (Complete Assy.) See Spinner Head Assembly section for individual parts breakdown.	42283	42283
2	BRUSH HOLDER ASSY (includes Brushes, Caps and Holders) See Brush Assembly Breakdown section for individual parts breakdown.	42382W	42382W
3	BELL HOUSING, DUAL BRUSH	42190	42190
4	LABEL,FLOSS ADVERTISEMENT	42159	42159
5	BOWL, SEAL RETAINER	56561	56561
6	BELL HOUSING SEAL	56571	56571
7	THREADED BUMPER,1/4-20	102017	102017
8	NAME,INSTRUCTION OVERLAY	102027	102023
9	SWITCH, LIGHTED ROCKER GR	42798	42798
10	KNOB, HEAT CONTROL	42556	42556
11	RUBBER FEET 3/4IN HIGH (4 required)	47155	47155
12	LOCK N GO HANDLE, NEW CAB.	56563	56563
13	5/16-18 X 1/2 PH TR M/S	12183	12183
14	WASHER SS .5 ID X 1.10 OD	48428	48428
15	CLAMPING SHAFT, LOCK N GO	56565	56565
16	CLAMPING CAM	42460	42460
17	5/16 FLAT WASHER ZINC PLT	74134	74134
18	HEX NUT 5/16-18 ESLOK	12001	12001
19*	POWER SUPPLY CORD	22038	22038
20	STRAIN RELIEF SR-6P3-4	76026	76026
21	WARNING LABEL CORD	68720	68720
22	8-32 X 3/8 PHIL PAN HEAD	87515	87515
23	1/4-20 X 3/4 GRADE 5 BOLT (w/Lock Washer)	74520	74520
24	TINNERMAN NUT 1/4-20	42125	42125
25	8-32 X 3/8 SLT. HWH M/S	42044	42044
26	#8-32 TINNERMAN FASTENER	47299	47299
27	INSPECTION BRUSH COVER	42381	42381
28	LABEL,CLEAN EVERY 500 LBS	42002	42002



## Cabinet Exterior and Lock-N-Go Handle Assembly – Parts List

Item	Part Description	Part Number	
		3017-00-000	3024-00-000
1	SPINNER HEAD, COMPLETE 5IN (Complete Assy.) See Spinner Head Assembly section for individual parts breakdown.	42283	42283
2	BRUSH HOLDER ASSY (includes Brushes, Caps and Holders) See Brush Assembly Breakdown section for individual parts breakdown.	42382W	42382W
3	BELL HOUSING, DUAL BRUSH	42190	42190
4	LABEL,FLOSS ADVERTISEMENT	42159	42159
5	BOWL, SEAL RETAINER	56561	56561
6	BELL HOUSING SEAL	56571	56571
7	THREADED BUMPER,1/4-20	102017	102017
8	NAME,INSTRUCTION OVERLAY	102027	102023
9	SWITCH, LIGHTED ROCKER GR	42798	42798
10	KNOB, HEAT CONTROL	42556	42556
11	RUBBER FEET 3/4IN HIGH (4 required)	47155	47155
12	LOCK N GO HANDLE, NEW CAB.	56563	56563
13	5/16-18 X 1/2 PH TR M/S	12183	12183
14	WASHER SS .5 ID X 1.10 OD	48428	48428
15	CLAMPING SHAFT, LOCK N GO	56565	56565
16	CLAMPING CAM	42460	42460
17	5/16 FLAT WASHER ZINC PLT	74134	74134
18	HEX NUT 5/16-18 ESLOK	12001	12001
19*	POWER SUPPLY CORD	22038	22038
20	STRAIN RELIEF SR-6P3-4	76026	76026
21	WARNING LABEL CORD	68720	68720
22	8-32 X 3/8 PHIL PAN HEAD	87515	87515
23	1/4-20 X 3/4 GRADE 5 BOLT (w/Lock Washer)	74520	74520
24	TINNERMAN NUT 1/4-20	42125	42125
25	8-32 X 3/8 SLT. HWH M/S	42044	42044
26	#8-32 TINNERMAN FASTENER	47299	47299
27	INSPECTION BRUSH COVER	42381	42381
28	LABEL,CLEAN EVERY 500 LBS	42002	42002



## Cabinet Exterior and Lock-N-Go Handle Assembly – Parts List

Item	Part Description	Part Number	
		3017-00-000	3024-00-000
1	SPINNER HEAD, COMPLETE 5IN (Complete Assy.) See Spinner Head Assembly section for individual parts breakdown.	42283	42283
2	BRUSH HOLDER ASSY (includes Brushes, Caps and Holders) See Brush Assembly Breakdown section for individual parts breakdown.	42382W	42382W
3	BELL HOUSING, DUAL BRUSH	42190	42190
4	LABEL,FLOSS ADVERTISEMENT	42159	42159
5	BOWL, SEAL RETAINER	56561	56561
6	BELL HOUSING SEAL	56571	56571
7	THREADED BUMPER,1/4-20	102017	102017
8	NAME,INSTRUCTION OVERLAY	102027	102023
9	SWITCH, LIGHTED ROCKER GR	42798	42798
10	KNOB, HEAT CONTROL	42556	42556
11	RUBBER FEET 3/4IN HIGH (4 required)	47155	47155
12	LOCK N GO HANDLE, NEW CAB.	56563	56563
13	5/16-18 X 1/2 PH TR M/S	12183	12183
14	WASHER SS .5 ID X 1.10 OD	48428	48428
15	CLAMPING SHAFT, LOCK N GO	56565	56565
16	CLAMPING CAM	42460	42460
17	5/16 FLAT WASHER ZINC PLT	74134	74134
18	HEX NUT 5/16-18 ESLOK	12001	12001
19*	POWER SUPPLY CORD	22038	22038
20	STRAIN RELIEF SR-6P3-4	76026	76026
21	WARNING LABEL CORD	68720	68720
22	8-32 X 3/8 PHIL PAN HEAD	87515	87515
23	1/4-20 X 3/4 GRADE 5 BOLT (w/Lock Washer)	74520	74520
24	TINNERMAN NUT 1/4-20	42125	42125
25	8-32 X 3/8 SLT. HWH M/S	42044	42044
26	#8-32 TINNERMAN FASTENER	47299	47299
27	INSPECTION BRUSH COVER	42381	42381
28	LABEL,CLEAN EVERY 500 LBS	42002	42002



## Cabinet Exterior and Lock-N-Go Handle Assembly – Parts List

Item	Part Description	Part Number	
		3017-00-000	3024-00-000
1	SPINNER HEAD, COMPLETE 5IN (Complete Assy.) See Spinner Head Assembly section for individual parts breakdown.	42283	42283
2	BRUSH HOLDER ASSY (includes Brushes, Caps and Holders) See Brush Assembly Breakdown section for individual parts breakdown.	42382W	42382W
3	BELL HOUSING, DUAL BRUSH	42190	42190
4	LABEL, FLOSS ADVERTISEMENT	42159	42159
5	BOWL, SEAL RETAINER	56561	56561
6	BELL HOUSING SEAL	56571	56571
7	THREADED BUMPER, 1/4-20	102017	102017
8	NAME, INSTRUCTION OVERLAY	102027	102023
9	SWITCH, LIGHTED ROCKER GR	42798	42798
10	KNOB, HEAT CONTROL	42556	42556
11	RUBBER FEET 3/4IN HIGH (4 required)	47155	47155
12	LOCK N GO HANDLE, NEW CAB.	56563	56563
13	5/16-18 X 1/2 PH TR M/S	12183	12183
14	WASHER SS .5 ID X 1.10 OD	48428	48428
15	CLAMPING SHAFT, LOCK N GO	56565	56565
16	CLAMPING CAM	42460	42460
17	5/16 FLAT WASHER ZINC PLT	74134	74134
18	HEX NUT 5/16-18 ESLOK	12001	12001
19*	POWER SUPPLY CORD	22038	22038
20	STRAIN RELIEF SR-6P3-4	76026	76026
21	WARNING LABEL CORD	68720	68720
22	8-32 X 3/8 PHIL PAN HEAD	87515	87515
23	1/4-20 X 3/4 GRADE 5 BOLT (w/Lock Washer)	74520	74520
24	TINNERMAN NUT 1/4-20	42125	42125
25	8-32 X 3/8 SLT. HWH M/S	42044	42044
26	#8-32 TINNERMAN FASTENER	47299	47299
27	INSPECTION BRUSH COVER	42381	42381
28	LABEL, CLEAN EVERY 500 LBS	42002	42002



## Cabinet Exterior and Lock-N-Go Handle Assembly – Parts List

Item	Part Description	Part Number	
		3017-00-000	3024-00-000
1	SPINNER HEAD, COMPLETE 5IN (Complete Assy.) See Spinner Head Assembly section for individual parts breakdown.	42283	42283
2	BRUSH HOLDER ASSY (includes Brushes, Caps and Holders) See Brush Assembly Breakdown section for individual parts breakdown.	42382W	42382W
3	BELL HOUSING, DUAL BRUSH	42190	42190
4	LABEL,FLOSS ADVERTISEMENT	42159	42159
5	BOWL, SEAL RETAINER	56561	56561
6	BELL HOUSING SEAL	56571	56571
7	THREADED BUMPER,1/4-20	102017	102017
8	NAME,INSTRUCTION OVERLAY	102027	102023
9	SWITCH, LIGHTED ROCKER GR	42798	42798
10	KNOB, HEAT CONTROL	42556	42556
11	RUBBER FEET 3/4IN HIGH (4 required)	47155	47155
12	LOCK N GO HANDLE, NEW CAB.	56563	56563
13	5/16-18 X 1/2 PH TR M/S	12183	12183
14	WASHER SS .5 ID X 1.10 OD	48428	48428
15	CLAMPING SHAFT, LOCK N GO	56565	56565
16	CLAMPING CAM	42460	42460
17	5/16 FLAT WASHER ZINC PLT	74134	74134
18	HEX NUT 5/16-18 ESLOK	12001	12001
19*	POWER SUPPLY CORD	22038	22038
20	STRAIN RELIEF SR-6P3-4	76026	76026
21	WARNING LABEL CORD	68720	68720
22	8-32 X 3/8 PHIL PAN HEAD	87515	87515
23	1/4-20 X 3/4 GRADE 5 BOLT (w/Lock Washer)	74520	74520
24	TINNERMAN NUT 1/4-20	42125	42125
25	8-32 X 3/8 SLT. HWH M/S	42044	42044
26	#8-32 TINNERMAN FASTENER	47299	47299
27	INSPECTION BRUSH COVER	42381	42381
28	LABEL,CLEAN EVERY 500 LBS	42002	42002



## Cabinet Exterior and Lock-N-Go Handle Assembly – Parts List

Item	Part Description	Part Number	
		3017-00-000	3024-00-000
1	SPINNER HEAD, COMPLETE 5IN (Complete Assy.) See Spinner Head Assembly section for individual parts breakdown.	42283	42283
2	BRUSH HOLDER ASSY (includes Brushes, Caps and Holders) See Brush Assembly Breakdown section for individual parts breakdown.	42382W	42382W
3	BELL HOUSING, DUAL BRUSH	42190	42190
4	LABEL,FLOSS ADVERTISEMENT	42159	42159
5	BOWL, SEAL RETAINER	56561	56561
6	BELL HOUSING SEAL	56571	56571
7	THREADED BUMPER,1/4-20	102017	102017
8	NAME,INSTRUCTION OVERLAY	102027	102023
9	SWITCH, LIGHTED ROCKER GR	42798	42798
10	KNOB, HEAT CONTROL	42556	42556
11	RUBBER FEET 3/4IN HIGH (4 required)	47155	47155
12	LOCK N GO HANDLE, NEW CAB.	56563	56563
13	5/16-18 X 1/2 PH TR M/S	12183	12183
14	WASHER SS .5 ID X 1.10 OD	48428	48428
15	CLAMPING SHAFT, LOCK N GO	56565	56565
16	CLAMPING CAM	42460	42460
17	5/16 FLAT WASHER ZINC PLT	74134	74134
18	HEX NUT 5/16-18 ESLOK	12001	12001
19*	POWER SUPPLY CORD	22038	22038
20	STRAIN RELIEF SR-6P3-4	76026	76026
21	WARNING LABEL CORD	68720	68720
22	8-32 X 3/8 PHIL PAN HEAD	87515	87515
23	1/4-20 X 3/4 GRADE 5 BOLT (w/Lock Washer)	74520	74520
24	TINNERMAN NUT 1/4-20	42125	42125
25	8-32 X 3/8 SLT. HWH M/S	42044	42044
26	#8-32 TINNERMAN FASTENER	47299	47299
27	INSPECTION BRUSH COVER	42381	42381
28	LABEL,CLEAN EVERY 500 LBS	42002	42002



## Cabinet Exterior and Lock-N-Go Handle Assembly – Parts List

Item	Part Description	Part Number	
		3017-00-000	3024-00-000
1	SPINNER HEAD, COMPLETE 5IN (Complete Assy.) See Spinner Head Assembly section for individual parts breakdown.	42283	42283
2	BRUSH HOLDER ASSY (includes Brushes, Caps and Holders) See Brush Assembly Breakdown section for individual parts breakdown.	42382W	42382W
3	BELL HOUSING, DUAL BRUSH	42190	42190
4	LABEL,FLOSS ADVERTISEMENT	42159	42159
5	BOWL, SEAL RETAINER	56561	56561
6	BELL HOUSING SEAL	56571	56571
7	THREADED BUMPER,1/4-20	102017	102017
8	NAME,INSTRUCTION OVERLAY	102027	102023
9	SWITCH, LIGHTED ROCKER GR	42798	42798
10	KNOB, HEAT CONTROL	42556	42556
11	RUBBER FEET 3/4IN HIGH (4 required)	47155	47155
12	LOCK N GO HANDLE, NEW CAB.	56563	56563
13	5/16-18 X 1/2 PH TR M/S	12183	12183
14	WASHER SS .5 ID X 1.10 OD	48428	48428
15	CLAMPING SHAFT, LOCK N GO	56565	56565
16	CLAMPING CAM	42460	42460
17	5/16 FLAT WASHER ZINC PLT	74134	74134
18	HEX NUT 5/16-18 ESLOK	12001	12001
19*	POWER SUPPLY CORD	22038	22038
20	STRAIN RELIEF SR-6P3-4	76026	76026
21	WARNING LABEL CORD	68720	68720
22	8-32 X 3/8 PHIL PAN HEAD	87515	87515
23	1/4-20 X 3/4 GRADE 5 BOLT (w/Lock Washer)	74520	74520
24	TINNERMAN NUT 1/4-20	42125	42125
25	8-32 X 3/8 SLT. HWH M/S	42044	42044
26	#8-32 TINNERMAN FASTENER	47299	47299
27	INSPECTION BRUSH COVER	42381	42381
28	LABEL,CLEAN EVERY 500 LBS	42002	42002



## Cabinet Exterior and Lock-N-Go Handle Assembly – Parts List

Item	Part Description	Part Number	
		3017-00-000	3024-00-000
1	SPINNER HEAD, COMPLETE 5IN (Complete Assy.) See Spinner Head Assembly section for individual parts breakdown.	42283	42283
2	BRUSH HOLDER ASSY (includes Brushes, Caps and Holders) See Brush Assembly Breakdown section for individual parts breakdown.	42382W	42382W
3	BELL HOUSING, DUAL BRUSH	42190	42190
4	LABEL,FLOSS ADVERTISEMENT	42159	42159
5	BOWL, SEAL RETAINER	56561	56561
6	BELL HOUSING SEAL	56571	56571
7	THREADED BUMPER,1/4-20	102017	102017
8	NAME,INSTRUCTION OVERLAY	102027	102023
9	SWITCH, LIGHTED ROCKER GR	42798	42798
10	KNOB, HEAT CONTROL	42556	42556
11	RUBBER FEET 3/4IN HIGH (4 required)	47155	47155
12	LOCK N GO HANDLE, NEW CAB.	56563	56563
13	5/16-18 X 1/2 PH TR M/S	12183	12183
14	WASHER SS .5 ID X 1.10 OD	48428	48428
15	CLAMPING SHAFT, LOCK N GO	56565	56565
16	CLAMPING CAM	42460	42460
17	5/16 FLAT WASHER ZINC PLT	74134	74134
18	HEX NUT 5/16-18 ESLOK	12001	12001
19*	POWER SUPPLY CORD	22038	22038
20	STRAIN RELIEF SR-6P3-4	76026	76026
21	WARNING LABEL CORD	68720	68720
22	8-32 X 3/8 PHIL PAN HEAD	87515	87515
23	1/4-20 X 3/4 GRADE 5 BOLT (w/Lock Washer)	74520	74520
24	TINNERMAN NUT 1/4-20	42125	42125
25	8-32 X 3/8 SLT. HWH M/S	42044	42044
26	#8-32 TINNERMAN FASTENER	47299	47299
27	INSPECTION BRUSH COVER	42381	42381
28	LABEL,CLEAN EVERY 500 LBS	42002	42002



## Cabinet Exterior and Lock-N-Go Handle Assembly – Parts List

Item	Part Description	Part Number	
		3017-00-000	3024-00-000
1	SPINNER HEAD, COMPLETE 5IN (Complete Assy.) See Spinner Head Assembly section for individual parts breakdown.	42283	42283
2	BRUSH HOLDER ASSY (includes Brushes, Caps and Holders) See Brush Assembly Breakdown section for individual parts breakdown.	42382W	42382W
3	BELL HOUSING, DUAL BRUSH	42190	42190
4	LABEL,FLOSS ADVERTISEMENT	42159	42159
5	BOWL, SEAL RETAINER	56561	56561
6	BELL HOUSING SEAL	56571	56571
7	THREADED BUMPER,1/4-20	102017	102017
8	NAME,INSTRUCTION OVERLAY	102027	102023
9	SWITCH, LIGHTED ROCKER GR	42798	42798
10	KNOB, HEAT CONTROL	42556	42556
11	RUBBER FEET 3/4IN HIGH (4 required)	47155	47155
12	LOCK N GO HANDLE, NEW CAB.	56563	56563
13	5/16-18 X 1/2 PH TR M/S	12183	12183
14	WASHER SS .5 ID X 1.10 OD	48428	48428
15	CLAMPING SHAFT, LOCK N GO	56565	56565
16	CLAMPING CAM	42460	42460
17	5/16 FLAT WASHER ZINC PLT	74134	74134
18	HEX NUT 5/16-18 ESLOK	12001	12001
19*	POWER SUPPLY CORD	22038	22038
20	STRAIN RELIEF SR-6P3-4	76026	76026
21	WARNING LABEL CORD	68720	68720
22	8-32 X 3/8 PHIL PAN HEAD	87515	87515
23	1/4-20 X 3/4 GRADE 5 BOLT (w/Lock Washer)	74520	74520
24	TINNERMAN NUT 1/4-20	42125	42125
25	8-32 X 3/8 SLT. HWH M/S	42044	42044
26	#8-32 TINNERMAN FASTENER	47299	47299
27	INSPECTION BRUSH COVER	42381	42381
28	LABEL,CLEAN EVERY 500 LBS	42002	42002



## Cabinet Exterior and Lock-N-Go Handle Assembly – Parts List

Item	Part Description	Part Number	
		3017-00-000	3024-00-000
1	SPINNER HEAD, COMPLETE 5IN (Complete Assy.) See Spinner Head Assembly section for individual parts breakdown.	42283	42283
2	BRUSH HOLDER ASSY (includes Brushes, Caps and Holders) See Brush Assembly Breakdown section for individual parts breakdown.	42382W	42382W
3	BELL HOUSING, DUAL BRUSH	42190	42190
4	LABEL,FLOSS ADVERTISEMENT	42159	42159
5	BOWL, SEAL RETAINER	56561	56561
6	BELL HOUSING SEAL	56571	56571
7	THREADED BUMPER,1/4-20	102017	102017
8	NAME,INSTRUCTION OVERLAY	102027	102023
9	SWITCH, LIGHTED ROCKER GR	42798	42798
10	KNOB, HEAT CONTROL	42556	42556
11	RUBBER FEET 3/4IN HIGH (4 required)	47155	47155
12	LOCK N GO HANDLE, NEW CAB.	56563	56563
13	5/16-18 X 1/2 PH TR M/S	12183	12183
14	WASHER SS .5 ID X 1.10 OD	48428	48428
15	CLAMPING SHAFT, LOCK N GO	56565	56565
16	CLAMPING CAM	42460	42460
17	5/16 FLAT WASHER ZINC PLT	74134	74134
18	HEX NUT 5/16-18 ESLOK	12001	12001
19*	POWER SUPPLY CORD	22038	22038
20	STRAIN RELIEF SR-6P3-4	76026	76026
21	WARNING LABEL CORD	68720	68720
22	8-32 X 3/8 PHIL PAN HEAD	87515	87515
23	1/4-20 X 3/4 GRADE 5 BOLT (w/Lock Washer)	74520	74520
24	TINNERMAN NUT 1/4-20	42125	42125
25	8-32 X 3/8 SLT. HWH M/S	42044	42044
26	#8-32 TINNERMAN FASTENER	47299	47299
27	INSPECTION BRUSH COVER	42381	42381
28	LABEL,CLEAN EVERY 500 LBS	42002	42002



## Cabinet Exterior and Lock-N-Go Handle Assembly – Parts List

Item	Part Description	Part Number	
		3017-00-000	3024-00-000
1	SPINNER HEAD, COMPLETE 5IN (Complete Assy.) See Spinner Head Assembly section for individual parts breakdown.	42283	42283
2	BRUSH HOLDER ASSY (includes Brushes, Caps and Holders) See Brush Assembly Breakdown section for individual parts breakdown.	42382W	42382W
3	BELL HOUSING, DUAL BRUSH	42190	42190
4	LABEL,FLOSS ADVERTISEMENT	42159	42159
5	BOWL, SEAL RETAINER	56561	56561
6	BELL HOUSING SEAL	56571	56571
7	THREADED BUMPER,1/4-20	102017	102017
8	NAME,INSTRUCTION OVERLAY	102027	102023
9	SWITCH, LIGHTED ROCKER GR	42798	42798
10	KNOB, HEAT CONTROL	42556	42556
11	RUBBER FEET 3/4IN HIGH (4 required)	47155	47155
12	LOCK N GO HANDLE, NEW CAB.	56563	56563
13	5/16-18 X 1/2 PH TR M/S	12183	12183
14	WASHER SS .5 ID X 1.10 OD	48428	48428
15	CLAMPING SHAFT, LOCK N GO	56565	56565
16	CLAMPING CAM	42460	42460
17	5/16 FLAT WASHER ZINC PLT	74134	74134
18	HEX NUT 5/16-18 ESLOK	12001	12001
19*	POWER SUPPLY CORD	22038	22038
20	STRAIN RELIEF SR-6P3-4	76026	76026
21	WARNING LABEL CORD	68720	68720
22	8-32 X 3/8 PHIL PAN HEAD	87515	87515
23	1/4-20 X 3/4 GRADE 5 BOLT (w/Lock Washer)	74520	74520
24	TINNERMAN NUT 1/4-20	42125	42125
25	8-32 X 3/8 SLT. HWH M/S	42044	42044
26	#8-32 TINNERMAN FASTENER	47299	47299
27	INSPECTION BRUSH COVER	42381	42381
28	LABEL,CLEAN EVERY 500 LBS	42002	42002



## Cabinet Exterior and Lock-N-Go Handle Assembly – Parts List

Item	Part Description	Part Number	
		3017-00-000	3024-00-000
1	SPINNER HEAD, COMPLETE 5IN (Complete Assy.) See Spinner Head Assembly section for individual parts breakdown.	42283	42283
2	BRUSH HOLDER ASSY (includes Brushes, Caps and Holders) See Brush Assembly Breakdown section for individual parts breakdown.	42382W	42382W
3	BELL HOUSING, DUAL BRUSH	42190	42190
4	LABEL,FLOSS ADVERTISEMENT	42159	42159
5	BOWL, SEAL RETAINER	56561	56561
6	BELL HOUSING SEAL	56571	56571
7	THREADED BUMPER,1/4-20	102017	102017
8	NAME,INSTRUCTION OVERLAY	102027	102023
9	SWITCH, LIGHTED ROCKER GR	42798	42798
10	KNOB, HEAT CONTROL	42556	42556
11	RUBBER FEET 3/4IN HIGH (4 required)	47155	47155
12	LOCK N GO HANDLE, NEW CAB.	56563	56563
13	5/16-18 X 1/2 PH TR M/S	12183	12183
14	WASHER SS .5 ID X 1.10 OD	48428	48428
15	CLAMPING SHAFT, LOCK N GO	56565	56565
16	CLAMPING CAM	42460	42460
17	5/16 FLAT WASHER ZINC PLT	74134	74134
18	HEX NUT 5/16-18 ESLOK	12001	12001
19*	POWER SUPPLY CORD	22038	22038
20	STRAIN RELIEF SR-6P3-4	76026	76026
21	WARNING LABEL CORD	68720	68720
22	8-32 X 3/8 PHIL PAN HEAD	87515	87515
23	1/4-20 X 3/4 GRADE 5 BOLT (w/Lock Washer)	74520	74520
24	TINNERMAN NUT 1/4-20	42125	42125
25	8-32 X 3/8 SLT. HWH M/S	42044	42044
26	#8-32 TINNERMAN FASTENER	47299	47299
27	INSPECTION BRUSH COVER	42381	42381
28	LABEL,CLEAN EVERY 500 LBS	42002	42002



## Cabinet Exterior and Lock-N-Go Handle Assembly – Parts List

Item	Part Description	Part Number	
		3017-00-000	3024-00-000
1	SPINNER HEAD, COMPLETE 5IN (Complete Assy.) See Spinner Head Assembly section for individual parts breakdown.	42283	42283
2	BRUSH HOLDER ASSY (includes Brushes, Caps and Holders) See Brush Assembly Breakdown section for individual parts breakdown.	42382W	42382W
3	BELL HOUSING, DUAL BRUSH	42190	42190
4	LABEL,FLOSS ADVERTISEMENT	42159	42159
5	BOWL, SEAL RETAINER	56561	56561
6	BELL HOUSING SEAL	56571	56571
7	THREADED BUMPER,1/4-20	102017	102017
8	NAME,INSTRUCTION OVERLAY	102027	102023
9	SWITCH, LIGHTED ROCKER GR	42798	42798
10	KNOB, HEAT CONTROL	42556	42556
11	RUBBER FEET 3/4IN HIGH (4 required)	47155	47155
12	LOCK N GO HANDLE, NEW CAB.	56563	56563
13	5/16-18 X 1/2 PH TR M/S	12183	12183
14	WASHER SS .5 ID X 1.10 OD	48428	48428
15	CLAMPING SHAFT, LOCK N GO	56565	56565
16	CLAMPING CAM	42460	42460
17	5/16 FLAT WASHER ZINC PLT	74134	74134
18	HEX NUT 5/16-18 ESLOK	12001	12001
19*	POWER SUPPLY CORD	22038	22038
20	STRAIN RELIEF SR-6P3-4	76026	76026
21	WARNING LABEL CORD	68720	68720
22	8-32 X 3/8 PHIL PAN HEAD	87515	87515
23	1/4-20 X 3/4 GRADE 5 BOLT (w/Lock Washer)	74520	74520
24	TINNERMAN NUT 1/4-20	42125	42125
25	8-32 X 3/8 SLT. HWH M/S	42044	42044
26	#8-32 TINNERMAN FASTENER	47299	47299
27	INSPECTION BRUSH COVER	42381	42381
28	LABEL,CLEAN EVERY 500 LBS	42002	42002



## Cabinet Exterior and Lock-N-Go Handle Assembly – Parts List

Item	Part Description	Part Number	
		3017-00-000	3024-00-000
1	SPINNER HEAD, COMPLETE 5IN (Complete Assy.) See Spinner Head Assembly section for individual parts breakdown.	42283	42283
2	BRUSH HOLDER ASSY (includes Brushes, Caps and Holders) See Brush Assembly Breakdown section for individual parts breakdown.	42382W	42382W
3	BELL HOUSING, DUAL BRUSH	42190	42190
4	LABEL,FLOSS ADVERTISEMENT	42159	42159
5	BOWL, SEAL RETAINER	56561	56561
6	BELL HOUSING SEAL	56571	56571
7	THREADED BUMPER,1/4-20	102017	102017
8	NAME,INSTRUCTION OVERLAY	102027	102023
9	SWITCH, LIGHTED ROCKER GR	42798	42798
10	KNOB, HEAT CONTROL	42556	42556
11	RUBBER FEET 3/4IN HIGH (4 required)	47155	47155
12	LOCK N GO HANDLE, NEW CAB.	56563	56563
13	5/16-18 X 1/2 PH TR M/S	12183	12183
14	WASHER SS .5 ID X 1.10 OD	48428	48428
15	CLAMPING SHAFT, LOCK N GO	56565	56565
16	CLAMPING CAM	42460	42460
17	5/16 FLAT WASHER ZINC PLT	74134	74134
18	HEX NUT 5/16-18 ESLOK	12001	12001
19*	POWER SUPPLY CORD	22038	22038
20	STRAIN RELIEF SR-6P3-4	76026	76026
21	WARNING LABEL CORD	68720	68720
22	8-32 X 3/8 PHIL PAN HEAD	87515	87515
23	1/4-20 X 3/4 GRADE 5 BOLT (w/Lock Washer)	74520	74520
24	TINNERMAN NUT 1/4-20	42125	42125
25	8-32 X 3/8 SLT. HWH M/S	42044	42044
26	#8-32 TINNERMAN FASTENER	47299	47299
27	INSPECTION BRUSH COVER	42381	42381
28	LABEL,CLEAN EVERY 500 LBS	42002	42002



## Cabinet Exterior and Lock-N-Go Handle Assembly – Parts List

Item	Part Description	Part Number	
		3017-00-000	3024-00-000
1	SPINNER HEAD, COMPLETE 5IN (Complete Assy.) See Spinner Head Assembly section for individual parts breakdown.	42283	42283
2	BRUSH HOLDER ASSY (includes Brushes, Caps and Holders) See Brush Assembly Breakdown section for individual parts breakdown.	42382W	42382W
3	BELL HOUSING, DUAL BRUSH	42190	42190
4	LABEL,FLOSS ADVERTISEMENT	42159	42159
5	BOWL, SEAL RETAINER	56561	56561
6	BELL HOUSING SEAL	56571	56571
7	THREADED BUMPER,1/4-20	102017	102017
8	NAME,INSTRUCTION OVERLAY	102027	102023
9	SWITCH, LIGHTED ROCKER GR	42798	42798
10	KNOB, HEAT CONTROL	42556	42556
11	RUBBER FEET 3/4IN HIGH (4 required)	47155	47155
12	LOCK N GO HANDLE, NEW CAB.	56563	56563
13	5/16-18 X 1/2 PH TR M/S	12183	12183
14	WASHER SS .5 ID X 1.10 OD	48428	48428
15	CLAMPING SHAFT, LOCK N GO	56565	56565
16	CLAMPING CAM	42460	42460
17	5/16 FLAT WASHER ZINC PLT	74134	74134
18	HEX NUT 5/16-18 ESLOK	12001	12001
19*	POWER SUPPLY CORD	22038	22038
20	STRAIN RELIEF SR-6P3-4	76026	76026
21	WARNING LABEL CORD	68720	68720
22	8-32 X 3/8 PHIL PAN HEAD	87515	87515
23	1/4-20 X 3/4 GRADE 5 BOLT (w/Lock Washer)	74520	74520
24	TINNERMAN NUT 1/4-20	42125	42125
25	8-32 X 3/8 SLT. HWH M/S	42044	42044
26	#8-32 TINNERMAN FASTENER	47299	47299
27	INSPECTION BRUSH COVER	42381	42381
28	LABEL,CLEAN EVERY 500 LBS	42002	42002



## Cabinet Exterior and Lock-N-Go Handle Assembly – Parts List

Item	Part Description	Part Number	
		3017-00-000	3024-00-000
1	SPINNER HEAD, COMPLETE 5IN (Complete Assy.) See Spinner Head Assembly section for individual parts breakdown.	42283	42283
2	BRUSH HOLDER ASSY (includes Brushes, Caps and Holders) See Brush Assembly Breakdown section for individual parts breakdown.	42382W	42382W
3	BELL HOUSING, DUAL BRUSH	42190	42190
4	LABEL,FLOSS ADVERTISEMENT	42159	42159
5	BOWL, SEAL RETAINER	56561	56561
6	BELL HOUSING SEAL	56571	56571
7	THREADED BUMPER,1/4-20	102017	102017
8	NAME,INSTRUCTION OVERLAY	102027	102023
9	SWITCH, LIGHTED ROCKER GR	42798	42798
10	KNOB, HEAT CONTROL	42556	42556
11	RUBBER FEET 3/4IN HIGH (4 required)	47155	47155
12	LOCK N GO HANDLE, NEW CAB.	56563	56563
13	5/16-18 X 1/2 PH TR M/S	12183	12183
14	WASHER SS .5 ID X 1.10 OD	48428	48428
15	CLAMPING SHAFT, LOCK N GO	56565	56565
16	CLAMPING CAM	42460	42460
17	5/16 FLAT WASHER ZINC PLT	74134	74134
18	HEX NUT 5/16-18 ESLOK	12001	12001
19*	POWER SUPPLY CORD	22038	22038
20	STRAIN RELIEF SR-6P3-4	76026	76026
21	WARNING LABEL CORD	68720	68720
22	8-32 X 3/8 PHIL PAN HEAD	87515	87515
23	1/4-20 X 3/4 GRADE 5 BOLT (w/Lock Washer)	74520	74520
24	TINNERMAN NUT 1/4-20	42125	42125
25	8-32 X 3/8 SLT. HWH M/S	42044	42044
26	#8-32 TINNERMAN FASTENER	47299	47299
27	INSPECTION BRUSH COVER	42381	42381
28	LABEL,CLEAN EVERY 500 LBS	42002	42002



## Cabinet Exterior and Lock-N-Go Handle Assembly – Parts List

Item	Part Description	Part Number	
		3017-00-000	3024-00-000
1	SPINNER HEAD, COMPLETE 5IN (Complete Assy.) See Spinner Head Assembly section for individual parts breakdown.	42283	42283
2	BRUSH HOLDER ASSY (includes Brushes, Caps and Holders) See Brush Assembly Breakdown section for individual parts breakdown.	42382W	42382W
3	BELL HOUSING, DUAL BRUSH	42190	42190
4	LABEL,FLOSS ADVERTISEMENT	42159	42159
5	BOWL, SEAL RETAINER	56561	56561
6	BELL HOUSING SEAL	56571	56571
7	THREADED BUMPER,1/4-20	102017	102017
8	NAME,INSTRUCTION OVERLAY	102027	102023
9	SWITCH, LIGHTED ROCKER GR	42798	42798
10	KNOB, HEAT CONTROL	42556	42556
11	RUBBER FEET 3/4IN HIGH (4 required)	47155	47155
12	LOCK N GO HANDLE, NEW CAB.	56563	56563
13	5/16-18 X 1/2 PH TR M/S	12183	12183
14	WASHER SS .5 ID X 1.10 OD	48428	48428
15	CLAMPING SHAFT, LOCK N GO	56565	56565
16	CLAMPING CAM	42460	42460
17	5/16 FLAT WASHER ZINC PLT	74134	74134
18	HEX NUT 5/16-18 ESLOK	12001	12001
19*	POWER SUPPLY CORD	22038	22038
20	STRAIN RELIEF SR-6P3-4	76026	76026
21	WARNING LABEL CORD	68720	68720
22	8-32 X 3/8 PHIL PAN HEAD	87515	87515
23	1/4-20 X 3/4 GRADE 5 BOLT (w/Lock Washer)	74520	74520
24	TINNERMAN NUT 1/4-20	42125	42125
25	8-32 X 3/8 SLT. HWH M/S	42044	42044
26	#8-32 TINNERMAN FASTENER	47299	47299
27	INSPECTION BRUSH COVER	42381	42381
28	LABEL,CLEAN EVERY 500 LBS	42002	42002



## Cabinet Exterior and Lock-N-Go Handle Assembly – Parts List

Item	Part Description	Part Number	
		3017-00-000	3024-00-000
1	SPINNER HEAD, COMPLETE 5IN (Complete Assy.) See Spinner Head Assembly section for individual parts breakdown.	42283	42283
2	BRUSH HOLDER ASSY (includes Brushes, Caps and Holders) See Brush Assembly Breakdown section for individual parts breakdown.	42382W	42382W
3	BELL HOUSING, DUAL BRUSH	42190	42190
4	LABEL,FLOSS ADVERTISEMENT	42159	42159
5	BOWL, SEAL RETAINER	56561	56561
6	BELL HOUSING SEAL	56571	56571
7	THREADED BUMPER,1/4-20	102017	102017
8	NAME,INSTRUCTION OVERLAY	102027	102023
9	SWITCH, LIGHTED ROCKER GR	42798	42798
10	KNOB, HEAT CONTROL	42556	42556
11	RUBBER FEET 3/4IN HIGH (4 required)	47155	47155
12	LOCK N GO HANDLE, NEW CAB.	56563	56563
13	5/16-18 X 1/2 PH TR M/S	12183	12183
14	WASHER SS .5 ID X 1.10 OD	48428	48428
15	CLAMPING SHAFT, LOCK N GO	56565	56565
16	CLAMPING CAM	42460	42460
17	5/16 FLAT WASHER ZINC PLT	74134	74134
18	HEX NUT 5/16-18 ESLOK	12001	12001
19*	POWER SUPPLY CORD	22038	22038
20	STRAIN RELIEF SR-6P3-4	76026	76026
21	WARNING LABEL CORD	68720	68720
22	8-32 X 3/8 PHIL PAN HEAD	87515	87515
23	1/4-20 X 3/4 GRADE 5 BOLT (w/Lock Washer)	74520	74520
24	TINNERMAN NUT 1/4-20	42125	42125
25	8-32 X 3/8 SLT. HWH M/S	42044	42044
26	#8-32 TINNERMAN FASTENER	47299	47299
27	INSPECTION BRUSH COVER	42381	42381
28	LABEL,CLEAN EVERY 500 LBS	42002	42002



## Cabinet Exterior and Lock-N-Go Handle Assembly – Parts List

Item	Part Description	Part Number	
		3017-00-000	3024-00-000
1	SPINNER HEAD, COMPLETE 5IN (Complete Assy.) See Spinner Head Assembly section for individual parts breakdown.	42283	42283
2	BRUSH HOLDER ASSY (includes Brushes, Caps and Holders) See Brush Assembly Breakdown section for individual parts breakdown.	42382W	42382W
3	BELL HOUSING, DUAL BRUSH	42190	42190
4	LABEL,FLOSS ADVERTISEMENT	42159	42159
5	BOWL, SEAL RETAINER	56561	56561
6	BELL HOUSING SEAL	56571	56571
7	THREADED BUMPER,1/4-20	102017	102017
8	NAME,INSTRUCTION OVERLAY	102027	102023
9	SWITCH, LIGHTED ROCKER GR	42798	42798
10	KNOB, HEAT CONTROL	42556	42556
11	RUBBER FEET 3/4IN HIGH (4 required)	47155	47155
12	LOCK N GO HANDLE, NEW CAB.	56563	56563
13	5/16-18 X 1/2 PH TR M/S	12183	12183
14	WASHER SS .5 ID X 1.10 OD	48428	48428
15	CLAMPING SHAFT, LOCK N GO	56565	56565
16	CLAMPING CAM	42460	42460
17	5/16 FLAT WASHER ZINC PLT	74134	74134
18	HEX NUT 5/16-18 ESLOK	12001	12001
19*	POWER SUPPLY CORD	22038	22038
20	STRAIN RELIEF SR-6P3-4	76026	76026
21	WARNING LABEL CORD	68720	68720
22	8-32 X 3/8 PHIL PAN HEAD	87515	87515
23	1/4-20 X 3/4 GRADE 5 BOLT (w/Lock Washer)	74520	74520
24	TINNERMAN NUT 1/4-20	42125	42125
25	8-32 X 3/8 SLT. HWH M/S	42044	42044
26	#8-32 TINNERMAN FASTENER	47299	47299
27	INSPECTION BRUSH COVER	42381	42381
28	LABEL,CLEAN EVERY 500 LBS	42002	42002



## Cabinet Exterior and Lock-N-Go Handle Assembly – Parts List

Item	Part Description	Part Number	
		3017-00-000	3024-00-000
1	SPINNER HEAD, COMPLETE 5IN (Complete Assy.) See Spinner Head Assembly section for individual parts breakdown.	42283	42283
2	BRUSH HOLDER ASSY (includes Brushes, Caps and Holders) See Brush Assembly Breakdown section for individual parts breakdown.	42382W	42382W
3	BELL HOUSING, DUAL BRUSH	42190	42190
4	LABEL,FLOSS ADVERTISEMENT	42159	42159
5	BOWL, SEAL RETAINER	56561	56561
6	BELL HOUSING SEAL	56571	56571
7	THREADED BUMPER,1/4-20	102017	102017
8	NAME,INSTRUCTION OVERLAY	102027	102023
9	SWITCH, LIGHTED ROCKER GR	42798	42798
10	KNOB, HEAT CONTROL	42556	42556
11	RUBBER FEET 3/4IN HIGH (4 required)	47155	47155
12	LOCK N GO HANDLE, NEW CAB.	56563	56563
13	5/16-18 X 1/2 PH TR M/S	12183	12183
14	WASHER SS .5 ID X 1.10 OD	48428	48428
15	CLAMPING SHAFT, LOCK N GO	56565	56565
16	CLAMPING CAM	42460	42460
17	5/16 FLAT WASHER ZINC PLT	74134	74134
18	HEX NUT 5/16-18 ESLOK	12001	12001
19*	POWER SUPPLY CORD	22038	22038
20	STRAIN RELIEF SR-6P3-4	76026	76026
21	WARNING LABEL CORD	68720	68720
22	8-32 X 3/8 PHIL PAN HEAD	87515	87515
23	1/4-20 X 3/4 GRADE 5 BOLT (w/Lock Washer)	74520	74520
24	TINNERMAN NUT 1/4-20	42125	42125
25	8-32 X 3/8 SLT. HWH M/S	42044	42044
26	#8-32 TINNERMAN FASTENER	47299	47299
27	INSPECTION BRUSH COVER	42381	42381
28	LABEL,CLEAN EVERY 500 LBS	42002	42002



## Cabinet Exterior and Lock-N-Go Handle Assembly – Parts List

Item	Part Description	Part Number	
		3017-00-000	3024-00-000
1	SPINNER HEAD, COMPLETE 5IN (Complete Assy.) See Spinner Head Assembly section for individual parts breakdown.	42283	42283
2	BRUSH HOLDER ASSY (includes Brushes, Caps and Holders) See Brush Assembly Breakdown section for individual parts breakdown.	42382W	42382W
3	BELL HOUSING, DUAL BRUSH	42190	42190
4	LABEL,FLOSS ADVERTISEMENT	42159	42159
5	BOWL, SEAL RETAINER	56561	56561
6	BELL HOUSING SEAL	56571	56571
7	THREADED BUMPER,1/4-20	102017	102017
8	NAME,INSTRUCTION OVERLAY	102027	102023
9	SWITCH, LIGHTED ROCKER GR	42798	42798
10	KNOB, HEAT CONTROL	42556	42556
11	RUBBER FEET 3/4IN HIGH (4 required)	47155	47155
12	LOCK N GO HANDLE, NEW CAB.	56563	56563
13	5/16-18 X 1/2 PH TR M/S	12183	12183
14	WASHER SS .5 ID X 1.10 OD	48428	48428
15	CLAMPING SHAFT, LOCK N GO	56565	56565
16	CLAMPING CAM	42460	42460
17	5/16 FLAT WASHER ZINC PLT	74134	74134
18	HEX NUT 5/16-18 ESLOK	12001	12001
19*	POWER SUPPLY CORD	22038	22038
20	STRAIN RELIEF SR-6P3-4	76026	76026
21	WARNING LABEL CORD	68720	68720
22	8-32 X 3/8 PHIL PAN HEAD	87515	87515
23	1/4-20 X 3/4 GRADE 5 BOLT (w/Lock Washer)	74520	74520
24	TINNERMAN NUT 1/4-20	42125	42125
25	8-32 X 3/8 SLT. HWH M/S	42044	42044
26	#8-32 TINNERMAN FASTENER	47299	47299
27	INSPECTION BRUSH COVER	42381	42381
28	LABEL,CLEAN EVERY 500 LBS	42002	42002



## Cabinet Exterior and Lock-N-Go Handle Assembly – Parts List

Item	Part Description	Part Number	
		3017-00-000	3024-00-000
1	SPINNER HEAD, COMPLETE 5IN (Complete Assy.) See Spinner Head Assembly section for individual parts breakdown.	42283	42283
2	BRUSH HOLDER ASSY (includes Brushes, Caps and Holders) See Brush Assembly Breakdown section for individual parts breakdown.	42382W	42382W
3	BELL HOUSING, DUAL BRUSH	42190	42190
4	LABEL,FLOSS ADVERTISEMENT	42159	42159
5	BOWL, SEAL RETAINER	56561	56561
6	BELL HOUSING SEAL	56571	56571
7	THREADED BUMPER,1/4-20	102017	102017
8	NAME,INSTRUCTION OVERLAY	102027	102023
9	SWITCH, LIGHTED ROCKER GR	42798	42798
10	KNOB, HEAT CONTROL	42556	42556
11	RUBBER FEET 3/4IN HIGH (4 required)	47155	47155
12	LOCK N GO HANDLE, NEW CAB.	56563	56563
13	5/16-18 X 1/2 PH TR M/S	12183	12183
14	WASHER SS .5 ID X 1.10 OD	48428	48428
15	CLAMPING SHAFT, LOCK N GO	56565	56565
16	CLAMPING CAM	42460	42460
17	5/16 FLAT WASHER ZINC PLT	74134	74134
18	HEX NUT 5/16-18 ESLOK	12001	12001
19*	POWER SUPPLY CORD	22038	22038
20	STRAIN RELIEF SR-6P3-4	76026	76026
21	WARNING LABEL CORD	68720	68720
22	8-32 X 3/8 PHIL PAN HEAD	87515	87515
23	1/4-20 X 3/4 GRADE 5 BOLT (w/Lock Washer)	74520	74520
24	TINNERMAN NUT 1/4-20	42125	42125
25	8-32 X 3/8 SLT. HWH M/S	42044	42044
26	#8-32 TINNERMAN FASTENER	47299	47299
27	INSPECTION BRUSH COVER	42381	42381
28	LABEL,CLEAN EVERY 500 LBS	42002	42002



## Cabinet Exterior and Lock-N-Go Handle Assembly – Parts List

Item	Part Description	Part Number	
		3017-00-000	3024-00-000
1	SPINNER HEAD, COMPLETE 5IN (Complete Assy.) See Spinner Head Assembly section for individual parts breakdown.	42283	42283
2	BRUSH HOLDER ASSY (includes Brushes, Caps and Holders) See Brush Assembly Breakdown section for individual parts breakdown.	42382W	42382W
3	BELL HOUSING, DUAL BRUSH	42190	42190
4	LABEL,FLOSS ADVERTISEMENT	42159	42159
5	BOWL, SEAL RETAINER	56561	56561
6	BELL HOUSING SEAL	56571	56571
7	THREADED BUMPER,1/4-20	102017	102017
8	NAME,INSTRUCTION OVERLAY	102027	102023
9	SWITCH, LIGHTED ROCKER GR	42798	42798
10	KNOB, HEAT CONTROL	42556	42556
11	RUBBER FEET 3/4IN HIGH (4 required)	47155	47155
12	LOCK N GO HANDLE, NEW CAB.	56563	56563
13	5/16-18 X 1/2 PH TR M/S	12183	12183
14	WASHER SS .5 ID X 1.10 OD	48428	48428
15	CLAMPING SHAFT, LOCK N GO	56565	56565
16	CLAMPING CAM	42460	42460
17	5/16 FLAT WASHER ZINC PLT	74134	74134
18	HEX NUT 5/16-18 ESLOK	12001	12001
19*	POWER SUPPLY CORD	22038	22038
20	STRAIN RELIEF SR-6P3-4	76026	76026
21	WARNING LABEL CORD	68720	68720
22	8-32 X 3/8 PHIL PAN HEAD	87515	87515
23	1/4-20 X 3/4 GRADE 5 BOLT (w/Lock Washer)	74520	74520
24	TINNERMAN NUT 1/4-20	42125	42125
25	8-32 X 3/8 SLT. HWH M/S	42044	42044
26	#8-32 TINNERMAN FASTENER	47299	47299
27	INSPECTION BRUSH COVER	42381	42381
28	LABEL,CLEAN EVERY 500 LBS	42002	42002



## Cabinet Exterior and Lock-N-Go Handle Assembly – Parts List

Item	Part Description	Part Number	
		3017-00-000	3024-00-000
1	SPINNER HEAD, COMPLETE 5IN (Complete Assy.) See Spinner Head Assembly section for individual parts breakdown.	42283	42283
2	BRUSH HOLDER ASSY (includes Brushes, Caps and Holders) See Brush Assembly Breakdown section for individual parts breakdown.	42382W	42382W
3	BELL HOUSING, DUAL BRUSH	42190	42190
4	LABEL,FLOSS ADVERTISEMENT	42159	42159
5	BOWL, SEAL RETAINER	56561	56561
6	BELL HOUSING SEAL	56571	56571
7	THREADED BUMPER,1/4-20	102017	102017
8	NAME,INSTRUCTION OVERLAY	102027	102023
9	SWITCH, LIGHTED ROCKER GR	42798	42798
10	KNOB, HEAT CONTROL	42556	42556
11	RUBBER FEET 3/4IN HIGH (4 required)	47155	47155
12	LOCK N GO HANDLE, NEW CAB.	56563	56563
13	5/16-18 X 1/2 PH TR M/S	12183	12183
14	WASHER SS .5 ID X 1.10 OD	48428	48428
15	CLAMPING SHAFT, LOCK N GO	56565	56565
16	CLAMPING CAM	42460	42460
17	5/16 FLAT WASHER ZINC PLT	74134	74134
18	HEX NUT 5/16-18 ESLOK	12001	12001
19*	POWER SUPPLY CORD	22038	22038
20	STRAIN RELIEF SR-6P3-4	76026	76026
21	WARNING LABEL CORD	68720	68720
22	8-32 X 3/8 PHIL PAN HEAD	87515	87515
23	1/4-20 X 3/4 GRADE 5 BOLT (w/Lock Washer)	74520	74520
24	TINNERMAN NUT 1/4-20	42125	42125
25	8-32 X 3/8 SLT. HWH M/S	42044	42044
26	#8-32 TINNERMAN FASTENER	47299	47299
27	INSPECTION BRUSH COVER	42381	42381
28	LABEL,CLEAN EVERY 500 LBS	42002	42002



## Cabinet Exterior and Lock-N-Go Handle Assembly – Parts List

Item	Part Description	Part Number	
		3017-00-000	3024-00-000
1	SPINNER HEAD, COMPLETE 5IN (Complete Assy.) See Spinner Head Assembly section for individual parts breakdown.	42283	42283
2	BRUSH HOLDER ASSY (includes Brushes, Caps and Holders) See Brush Assembly Breakdown section for individual parts breakdown.	42382W	42382W
3	BELL HOUSING, DUAL BRUSH	42190	42190
4	LABEL,FLOSS ADVERTISEMENT	42159	42159
5	BOWL, SEAL RETAINER	56561	56561
6	BELL HOUSING SEAL	56571	56571
7	THREADED BUMPER,1/4-20	102017	102017
8	NAME,INSTRUCTION OVERLAY	102027	102023
9	SWITCH, LIGHTED ROCKER GR	42798	42798
10	KNOB, HEAT CONTROL	42556	42556
11	RUBBER FEET 3/4IN HIGH (4 required)	47155	47155
12	LOCK N GO HANDLE, NEW CAB.	56563	56563
13	5/16-18 X 1/2 PH TR M/S	12183	12183
14	WASHER SS .5 ID X 1.10 OD	48428	48428
15	CLAMPING SHAFT, LOCK N GO	56565	56565
16	CLAMPING CAM	42460	42460
17	5/16 FLAT WASHER ZINC PLT	74134	74134
18	HEX NUT 5/16-18 ESLOK	12001	12001
19*	POWER SUPPLY CORD	22038	22038
20	STRAIN RELIEF SR-6P3-4	76026	76026
21	WARNING LABEL CORD	68720	68720
22	8-32 X 3/8 PHIL PAN HEAD	87515	87515
23	1/4-20 X 3/4 GRADE 5 BOLT (w/Lock Washer)	74520	74520
24	TINNERMAN NUT 1/4-20	42125	42125
25	8-32 X 3/8 SLT. HWH M/S	42044	42044
26	#8-32 TINNERMAN FASTENER	47299	47299
27	INSPECTION BRUSH COVER	42381	42381
28	LABEL,CLEAN EVERY 500 LBS	42002	42002



## Cabinet Exterior and Lock-N-Go Handle Assembly – Parts List

Item	Part Description	Part Number	
		3017-00-000	3024-00-000
1	SPINNER HEAD, COMPLETE 5IN (Complete Assy.) See Spinner Head Assembly section for individual parts breakdown.	42283	42283
2	BRUSH HOLDER ASSY (includes Brushes, Caps and Holders) See Brush Assembly Breakdown section for individual parts breakdown.	42382W	42382W
3	BELL HOUSING, DUAL BRUSH	42190	42190
4	LABEL,FLOSS ADVERTISEMENT	42159	42159
5	BOWL, SEAL RETAINER	56561	56561
6	BELL HOUSING SEAL	56571	56571
7	THREADED BUMPER,1/4-20	102017	102017
8	NAME,INSTRUCTION OVERLAY	102027	102023
9	SWITCH, LIGHTED ROCKER GR	42798	42798
10	KNOB, HEAT CONTROL	42556	42556
11	RUBBER FEET 3/4IN HIGH (4 required)	47155	47155
12	LOCK N GO HANDLE, NEW CAB.	56563	56563
13	5/16-18 X 1/2 PH TR M/S	12183	12183
14	WASHER SS .5 ID X 1.10 OD	48428	48428
15	CLAMPING SHAFT, LOCK N GO	56565	56565
16	CLAMPING CAM	42460	42460
17	5/16 FLAT WASHER ZINC PLT	74134	74134
18	HEX NUT 5/16-18 ESLOK	12001	12001
19*	POWER SUPPLY CORD	22038	22038
20	STRAIN RELIEF SR-6P3-4	76026	76026
21	WARNING LABEL CORD	68720	68720
22	8-32 X 3/8 PHIL PAN HEAD	87515	87515
23	1/4-20 X 3/4 GRADE 5 BOLT (w/Lock Washer)	74520	74520
24	TINNERMAN NUT 1/4-20	42125	42125
25	8-32 X 3/8 SLT. HWH M/S	42044	42044
26	#8-32 TINNERMAN FASTENER	47299	47299
27	INSPECTION BRUSH COVER	42381	42381
28	LABEL,CLEAN EVERY 500 LBS	42002	42002



## Cabinet Exterior and Lock-N-Go Handle Assembly – Parts List

Item	Part Description	Part Number	
		3017-00-000	3024-00-000
1	SPINNER HEAD, COMPLETE 5IN (Complete Assy.) See Spinner Head Assembly section for individual parts breakdown.	42283	42283
2	BRUSH HOLDER ASSY (includes Brushes, Caps and Holders) See Brush Assembly Breakdown section for individual parts breakdown.	42382W	42382W
3	BELL HOUSING, DUAL BRUSH	42190	42190
4	LABEL,FLOSS ADVERTISEMENT	42159	42159
5	BOWL, SEAL RETAINER	56561	56561
6	BELL HOUSING SEAL	56571	56571
7	THREADED BUMPER,1/4-20	102017	102017
8	NAME,INSTRUCTION OVERLAY	102027	102023
9	SWITCH, LIGHTED ROCKER GR	42798	42798
10	KNOB, HEAT CONTROL	42556	42556
11	RUBBER FEET 3/4IN HIGH (4 required)	47155	47155
12	LOCK N GO HANDLE, NEW CAB.	56563	56563
13	5/16-18 X 1/2 PH TR M/S	12183	12183
14	WASHER SS .5 ID X 1.10 OD	48428	48428
15	CLAMPING SHAFT, LOCK N GO	56565	56565
16	CLAMPING CAM	42460	42460
17	5/16 FLAT WASHER ZINC PLT	74134	74134
18	HEX NUT 5/16-18 ESLOK	12001	12001
19*	POWER SUPPLY CORD	22038	22038
20	STRAIN RELIEF SR-6P3-4	76026	76026
21	WARNING LABEL CORD	68720	68720
22	8-32 X 3/8 PHIL PAN HEAD	87515	87515
23	1/4-20 X 3/4 GRADE 5 BOLT (w/Lock Washer)	74520	74520
24	TINNERMAN NUT 1/4-20	42125	42125
25	8-32 X 3/8 SLT. HWH M/S	42044	42044
26	#8-32 TINNERMAN FASTENER	47299	47299
27	INSPECTION BRUSH COVER	42381	42381
28	LABEL,CLEAN EVERY 500 LBS	42002	42002



## Cabinet Exterior and Lock-N-Go Handle Assembly – Parts List

Item	Part Description	Part Number	
		3017-00-000	3024-00-000
1	SPINNER HEAD, COMPLETE 5IN (Complete Assy.) See Spinner Head Assembly section for individual parts breakdown.	42283	42283
2	BRUSH HOLDER ASSY (includes Brushes, Caps and Holders) See Brush Assembly Breakdown section for individual parts breakdown.	42382W	42382W
3	BELL HOUSING, DUAL BRUSH	42190	42190
4	LABEL,FLOSS ADVERTISEMENT	42159	42159
5	BOWL, SEAL RETAINER	56561	56561
6	BELL HOUSING SEAL	56571	56571
7	THREADED BUMPER,1/4-20	102017	102017
8	NAME,INSTRUCTION OVERLAY	102027	102023
9	SWITCH, LIGHTED ROCKER GR	42798	42798
10	KNOB, HEAT CONTROL	42556	42556
11	RUBBER FEET 3/4IN HIGH (4 required)	47155	47155
12	LOCK N GO HANDLE, NEW CAB.	56563	56563
13	5/16-18 X 1/2 PH TR M/S	12183	12183
14	WASHER SS .5 ID X 1.10 OD	48428	48428
15	CLAMPING SHAFT, LOCK N GO	56565	56565
16	CLAMPING CAM	42460	42460
17	5/16 FLAT WASHER ZINC PLT	74134	74134
18	HEX NUT 5/16-18 ESLOK	12001	12001
19*	POWER SUPPLY CORD	22038	22038
20	STRAIN RELIEF SR-6P3-4	76026	76026
21	WARNING LABEL CORD	68720	68720
22	8-32 X 3/8 PHIL PAN HEAD	87515	87515
23	1/4-20 X 3/4 GRADE 5 BOLT (w/Lock Washer)	74520	74520
24	TINNERMAN NUT 1/4-20	42125	42125
25	8-32 X 3/8 SLT. HWH M/S	42044	42044
26	#8-32 TINNERMAN FASTENER	47299	47299
27	INSPECTION BRUSH COVER	42381	42381
28	LABEL,CLEAN EVERY 500 LBS	42002	42002



## Cabinet Exterior and Lock-N-Go Handle Assembly – Parts List

Item	Part Description	Part Number	
		3017-00-000	3024-00-000
1	SPINNER HEAD, COMPLETE 5IN (Complete Assy.) See Spinner Head Assembly section for individual parts breakdown.	42283	42283
2	BRUSH HOLDER ASSY (includes Brushes, Caps and Holders) See Brush Assembly Breakdown section for individual parts breakdown.	42382W	42382W
3	BELL HOUSING, DUAL BRUSH	42190	42190
4	LABEL,FLOSS ADVERTISEMENT	42159	42159
5	BOWL, SEAL RETAINER	56561	56561
6	BELL HOUSING SEAL	56571	56571
7	THREADED BUMPER,1/4-20	102017	102017
8	NAME,INSTRUCTION OVERLAY	102027	102023
9	SWITCH, LIGHTED ROCKER GR	42798	42798
10	KNOB, HEAT CONTROL	42556	42556
11	RUBBER FEET 3/4IN HIGH (4 required)	47155	47155
12	LOCK N GO HANDLE, NEW CAB.	56563	56563
13	5/16-18 X 1/2 PH TR M/S	12183	12183
14	WASHER SS .5 ID X 1.10 OD	48428	48428
15	CLAMPING SHAFT, LOCK N GO	56565	56565
16	CLAMPING CAM	42460	42460
17	5/16 FLAT WASHER ZINC PLT	74134	74134
18	HEX NUT 5/16-18 ESLOK	12001	12001
19*	POWER SUPPLY CORD	22038	22038
20	STRAIN RELIEF SR-6P3-4	76026	76026
21	WARNING LABEL CORD	68720	68720
22	8-32 X 3/8 PHIL PAN HEAD	87515	87515
23	1/4-20 X 3/4 GRADE 5 BOLT (w/Lock Washer)	74520	74520
24	TINNERMAN NUT 1/4-20	42125	42125
25	8-32 X 3/8 SLT. HWH M/S	42044	42044
26	#8-32 TINNERMAN FASTENER	47299	47299
27	INSPECTION BRUSH COVER	42381	42381
28	LABEL,CLEAN EVERY 500 LBS	42002	42002



## Cabinet Exterior and Lock-N-Go Handle Assembly – Parts List

Item	Part Description	Part Number	
		3017-00-000	3024-00-000
1	SPINNER HEAD, COMPLETE 5IN (Complete Assy.) See Spinner Head Assembly section for individual parts breakdown.	42283	42283
2	BRUSH HOLDER ASSY (includes Brushes, Caps and Holders) See Brush Assembly Breakdown section for individual parts breakdown.	42382W	42382W
3	BELL HOUSING, DUAL BRUSH	42190	42190
4	LABEL,FLOSS ADVERTISEMENT	42159	42159
5	BOWL, SEAL RETAINER	56561	56561
6	BELL HOUSING SEAL	56571	56571
7	THREADED BUMPER,1/4-20	102017	102017
8	NAME,INSTRUCTION OVERLAY	102027	102023
9	SWITCH, LIGHTED ROCKER GR	42798	42798
10	KNOB, HEAT CONTROL	42556	42556
11	RUBBER FEET 3/4IN HIGH (4 required)	47155	47155
12	LOCK N GO HANDLE, NEW CAB.	56563	56563
13	5/16-18 X 1/2 PH TR M/S	12183	12183
14	WASHER SS .5 ID X 1.10 OD	48428	48428
15	CLAMPING SHAFT, LOCK N GO	56565	56565
16	CLAMPING CAM	42460	42460
17	5/16 FLAT WASHER ZINC PLT	74134	74134
18	HEX NUT 5/16-18 ESLOK	12001	12001
19*	POWER SUPPLY CORD	22038	22038
20	STRAIN RELIEF SR-6P3-4	76026	76026
21	WARNING LABEL CORD	68720	68720
22	8-32 X 3/8 PHIL PAN HEAD	87515	87515
23	1/4-20 X 3/4 GRADE 5 BOLT (w/Lock Washer)	74520	74520
24	TINNERMAN NUT 1/4-20	42125	42125
25	8-32 X 3/8 SLT. HWH M/S	42044	42044
26	#8-32 TINNERMAN FASTENER	47299	47299
27	INSPECTION BRUSH COVER	42381	42381
28	LABEL,CLEAN EVERY 500 LBS	42002	42002



## Cabinet Exterior and Lock-N-Go Handle Assembly – Parts List

Item	Part Description	Part Number	
		3017-00-000	3024-00-000
1	SPINNER HEAD, COMPLETE 5IN (Complete Assy.) See Spinner Head Assembly section for individual parts breakdown.	42283	42283
2	BRUSH HOLDER ASSY (includes Brushes, Caps and Holders) See Brush Assembly Breakdown section for individual parts breakdown.	42382W	42382W
3	BELL HOUSING, DUAL BRUSH	42190	42190
4	LABEL,FLOSS ADVERTISEMENT	42159	42159
5	BOWL, SEAL RETAINER	56561	56561
6	BELL HOUSING SEAL	56571	56571
7	THREADED BUMPER,1/4-20	102017	102017
8	NAME,INSTRUCTION OVERLAY	102027	102023
9	SWITCH, LIGHTED ROCKER GR	42798	42798
10	KNOB, HEAT CONTROL	42556	42556
11	RUBBER FEET 3/4IN HIGH (4 required)	47155	47155
12	LOCK N GO HANDLE, NEW CAB.	56563	56563
13	5/16-18 X 1/2 PH TR M/S	12183	12183
14	WASHER SS .5 ID X 1.10 OD	48428	48428
15	CLAMPING SHAFT, LOCK N GO	56565	56565
16	CLAMPING CAM	42460	42460
17	5/16 FLAT WASHER ZINC PLT	74134	74134
18	HEX NUT 5/16-18 ESLOK	12001	12001
19*	POWER SUPPLY CORD	22038	22038
20	STRAIN RELIEF SR-6P3-4	76026	76026
21	WARNING LABEL CORD	68720	68720
22	8-32 X 3/8 PHIL PAN HEAD	87515	87515
23	1/4-20 X 3/4 GRADE 5 BOLT (w/Lock Washer)	74520	74520
24	TINNERMAN NUT 1/4-20	42125	42125
25	8-32 X 3/8 SLT. HWH M/S	42044	42044
26	#8-32 TINNERMAN FASTENER	47299	47299
27	INSPECTION BRUSH COVER	42381	42381
28	LABEL,CLEAN EVERY 500 LBS	42002	42002



## Cabinet Exterior and Lock-N-Go Handle Assembly – Parts List

Item	Part Description	Part Number	
		3017-00-000	3024-00-000
1	SPINNER HEAD, COMPLETE 5IN (Complete Assy.) See Spinner Head Assembly section for individual parts breakdown.	42283	42283
2	BRUSH HOLDER ASSY (includes Brushes, Caps and Holders) See Brush Assembly Breakdown section for individual parts breakdown.	42382W	42382W
3	BELL HOUSING, DUAL BRUSH	42190	42190
4	LABEL,FLOSS ADVERTISEMENT	42159	42159
5	BOWL, SEAL RETAINER	56561	56561
6	BELL HOUSING SEAL	56571	56571
7	THREADED BUMPER,1/4-20	102017	102017
8	NAME,INSTRUCTION OVERLAY	102027	102023
9	SWITCH, LIGHTED ROCKER GR	42798	42798
10	KNOB, HEAT CONTROL	42556	42556
11	RUBBER FEET 3/4IN HIGH (4 required)	47155	47155
12	LOCK N GO HANDLE, NEW CAB.	56563	56563
13	5/16-18 X 1/2 PH TR M/S	12183	12183
14	WASHER SS .5 ID X 1.10 OD	48428	48428
15	CLAMPING SHAFT, LOCK N GO	56565	56565
16	CLAMPING CAM	42460	42460
17	5/16 FLAT WASHER ZINC PLT	74134	74134
18	HEX NUT 5/16-18 ESLOK	12001	12001
19*	POWER SUPPLY CORD	22038	22038
20	STRAIN RELIEF SR-6P3-4	76026	76026
21	WARNING LABEL CORD	68720	68720
22	8-32 X 3/8 PHIL PAN HEAD	87515	87515
23	1/4-20 X 3/4 GRADE 5 BOLT (w/Lock Washer)	74520	74520
24	TINNERMAN NUT 1/4-20	42125	42125
25	8-32 X 3/8 SLT. HWH M/S	42044	42044
26	#8-32 TINNERMAN FASTENER	47299	47299
27	INSPECTION BRUSH COVER	42381	42381
28	LABEL,CLEAN EVERY 500 LBS	42002	42002



## Cabinet Exterior and Lock-N-Go Handle Assembly – Parts List

Item	Part Description	Part Number	
		3017-00-000	3024-00-000
1	SPINNER HEAD, COMPLETE 5IN (Complete Assy.) See Spinner Head Assembly section for individual parts breakdown.	42283	42283
2	BRUSH HOLDER ASSY (includes Brushes, Caps and Holders) See Brush Assembly Breakdown section for individual parts breakdown.	42382W	42382W
3	BELL HOUSING, DUAL BRUSH	42190	42190
4	LABEL,FLOSS ADVERTISEMENT	42159	42159
5	BOWL, SEAL RETAINER	56561	56561
6	BELL HOUSING SEAL	56571	56571
7	THREADED BUMPER,1/4-20	102017	102017
8	NAME,INSTRUCTION OVERLAY	102027	102023
9	SWITCH, LIGHTED ROCKER GR	42798	42798
10	KNOB, HEAT CONTROL	42556	42556
11	RUBBER FEET 3/4IN HIGH (4 required)	47155	47155
12	LOCK N GO HANDLE, NEW CAB.	56563	56563
13	5/16-18 X 1/2 PH TR M/S	12183	12183
14	WASHER SS .5 ID X 1.10 OD	48428	48428
15	CLAMPING SHAFT, LOCK N GO	56565	56565
16	CLAMPING CAM	42460	42460
17	5/16 FLAT WASHER ZINC PLT	74134	74134
18	HEX NUT 5/16-18 ESLOK	12001	12001
19*	POWER SUPPLY CORD	22038	22038
20	STRAIN RELIEF SR-6P3-4	76026	76026
21	WARNING LABEL CORD	68720	68720
22	8-32 X 3/8 PHIL PAN HEAD	87515	87515
23	1/4-20 X 3/4 GRADE 5 BOLT (w/Lock Washer)	74520	74520
24	TINNERMAN NUT 1/4-20	42125	42125
25	8-32 X 3/8 SLT. HWH M/S	42044	42044
26	#8-32 TINNERMAN FASTENER	47299	47299
27	INSPECTION BRUSH COVER	42381	42381
28	LABEL,CLEAN EVERY 500 LBS	42002	42002

## 5" Ribbon Spinner Head (Model No. 42283)

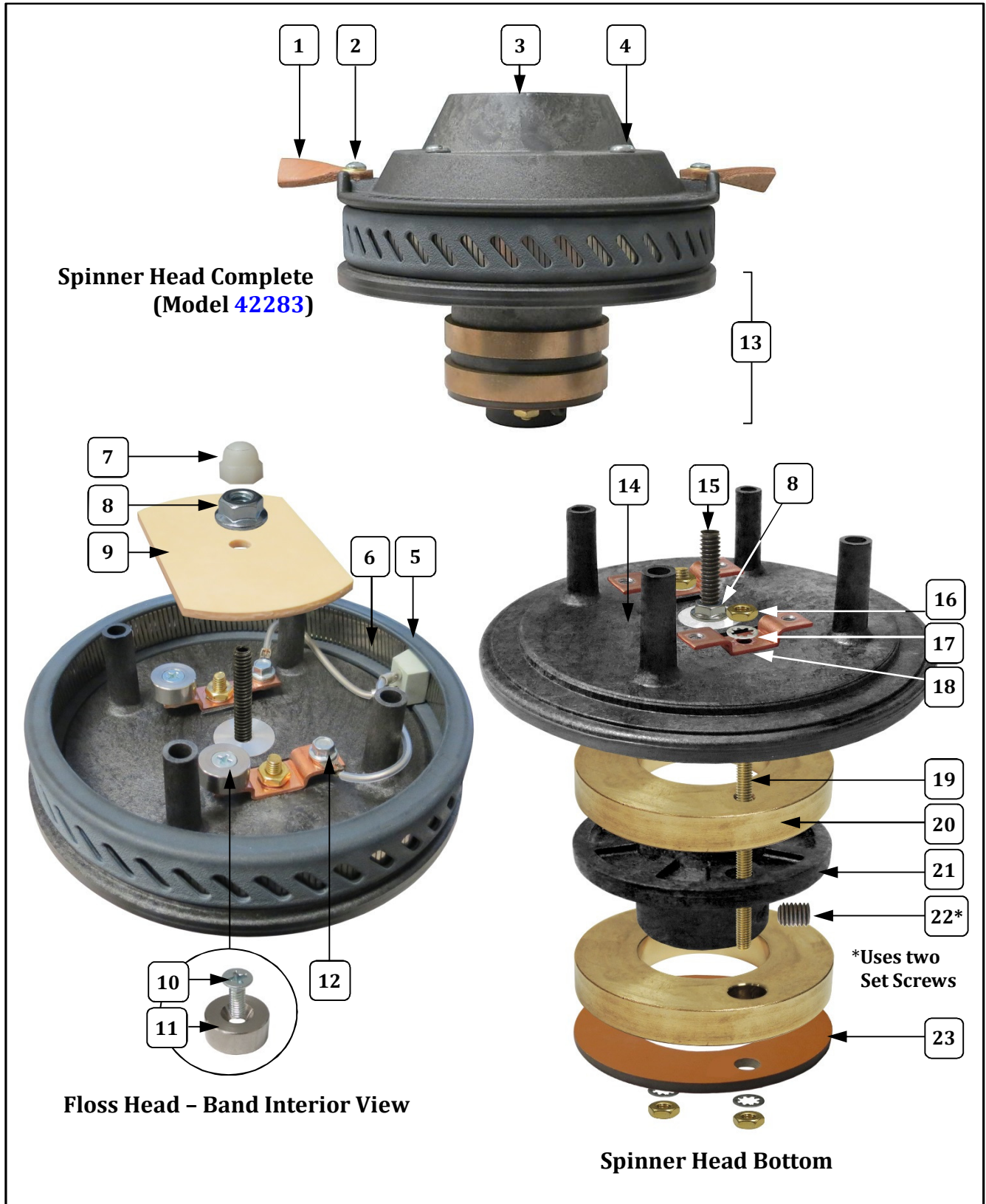

## 5" Ribbon Spinner Head (Model No. 42283)

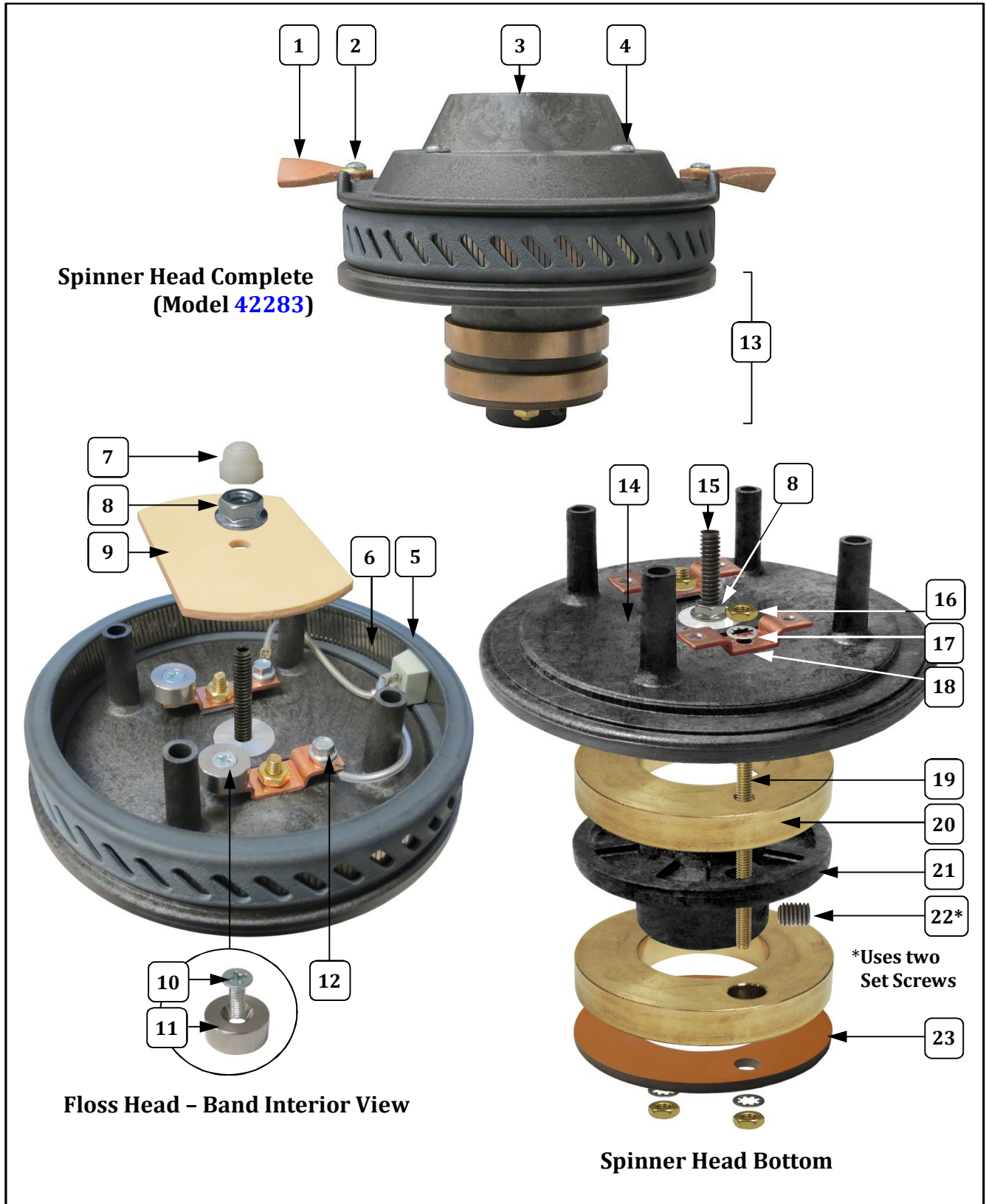



## 5" Ribbon Spinner Head (Model No. 42283) – Parts List

Item	Part Description	Part Number
		42283
1	LEATHER FLOATER	20010
2	SCREW 8-32 X 5/16 PH PAN MS	89247
3	HIGH CAPACITY SPINNER CAP	43166
4	10-24 X 2 PHIL/SLT MS	42041
5	5 1/2 FLOSS BAND	43165
6	11 OHM RIBBON ASSEMBLY	42251
7	1/4 - 20 NYLON ACORN NUT	48041
8	1/4 - 20 SERRATED LOCK NUT	46311
9	PHENOLIC TERMINAL GUARD	42162
10	8-32X1/2 FL HD PH MS	20066
11	BALANCE WEIGHT	43422
12	8-32 X 1/4 HX HD WHIZ LOCK	42045
13	SPINNER HEAD BOTTOM (Complete assembly includes 2 element lead screws, Terminal Guard, Nylon Nut, Lock Nut, and items listed below.)	42284
14	UPPER SPINNER HEAD	42437
15	1/4-20 X 2-3/4 SET SCREW	42413
16	HEX NUT #10-32 BRASS	42301
17	#10 INTERNAL TOOTH WASHER	12573
18	TERMINAL ASSEMBLY	42305
19	SLIP RING STUD	42127
20	SLIP RING MACHINED	42126HD
21	LOWER SPINNER HEAD 1/2	42281
22	SET SCREW 1/4-20 X 3/8 (2 required for the Lower Spinner Head)	74125
23	BOTTOM PHENOLIC WASHER	20054



## 5" Ribbon Spinner Head (Model No. 42283) – Parts List

Item	Part Description	Part Number
		42283
1	LEATHER FLOATER	20010
2	SCREW 8-32 X 5/16 PH PAN MS	89247
3	HIGH CAPACITY SPINNER CAP	43166
4	10-24 X 2 PHIL/SLT MS	42041
5	5 1/2 FLOSS BAND	43165
6	11 OHM RIBBON ASSEMBLY	42251
7	1/4 - 20 NYLON ACORN NUT	48041
8	1/4 - 20 SERRATED LOCK NUT	46311
9	PHENOLIC TERMINAL GUARD	42162
10	8-32X1/2 FL HD PH MS	20066
11	BALANCE WEIGHT	43422
12	8-32 X 1/4 HX HD WHIZ LOCK	42045
13	SPINNER HEAD BOTTOM (Complete assembly includes 2 element lead screws, Terminal Guard, Nylon Nut, Lock Nut, and items listed below.)	42284
14	UPPER SPINNER HEAD	42437
15	1/4-20 X 2-3/4 SET SCREW	42413
16	HEX NUT #10-32 BRASS	42301
17	#10 INTERNAL TOOTH WASHER	12573
18	TERMINAL ASSEMBLY	42305
19	SLIP RING STUD	42127
20	SLIP RING MACHINED	42126HD
21	LOWER SPINNER HEAD 1/2	42281
22	SET SCREW 1/4-20 X 3/8 (2 required for the Lower Spinner Head)	74125
23	BOTTOM PHENOLIC WASHER	20054



## 5" Ribbon Spinner Head (Model No. 42283) – Parts List

Item	Part Description	Part Number
		42283
1	LEATHER FLOATER	20010
2	SCREW 8-32 X 5/16 PH PAN MS	89247
3	HIGH CAPACITY SPINNER CAP	43166
4	10-24 X 2 PHIL/SLT MS	42041
5	5 1/2 FLOSS BAND	43165
6	11 OHM RIBBON ASSEMBLY	42251
7	1/4 - 20 NYLON ACORN NUT	48041
8	1/4 - 20 SERRATED LOCK NUT	46311
9	PHENOLIC TERMINAL GUARD	42162
10	8-32X1/2 FL HD PH MS	20066
11	BALANCE WEIGHT	43422
12	8-32 X 1/4 HX HD WHIZ LOCK	42045
13	SPINNER HEAD BOTTOM (Complete assembly includes 2 element lead screws, Terminal Guard, Nylon Nut, Lock Nut, and items listed below.)	42284
14	UPPER SPINNER HEAD	42437
15	1/4-20 X 2-3/4 SET SCREW	42413
16	HEX NUT #10-32 BRASS	42301
17	#10 INTERNAL TOOTH WASHER	12573
18	TERMINAL ASSEMBLY	42305
19	SLIP RING STUD	42127
20	SLIP RING MACHINED	42126HD
21	LOWER SPINNER HEAD 1/2	42281
22	SET SCREW 1/4-20 X 3/8 (2 required for the Lower Spinner Head)	74125
23	BOTTOM PHENOLIC WASHER	20054



## 5" Ribbon Spinner Head (Model No. 42283) – Parts List

Item	Part Description	Part Number
		42283
1	LEATHER FLOATER	20010
2	SCREW 8-32 X 5/16 PH PAN MS	89247
3	HIGH CAPACITY SPINNER CAP	43166
4	10-24 X 2 PHIL/SLT MS	42041
5	5 1/2 FLOSS BAND	43165
6	11 OHM RIBBON ASSEMBLY	42251
7	1/4 - 20 NYLON ACORN NUT	48041
8	1/4 - 20 SERRATED LOCK NUT	46311
9	PHENOLIC TERMINAL GUARD	42162
10	8-32X1/2 FL HD PH MS	20066
11	BALANCE WEIGHT	43422
12	8-32 X 1/4 HX HD WHIZ LOCK	42045
13	SPINNER HEAD BOTTOM (Complete assembly includes 2 element lead screws, Terminal Guard, Nylon Nut, Lock Nut, and items listed below.)	42284
14	UPPER SPINNER HEAD	42437
15	1/4-20 X 2-3/4 SET SCREW	42413
16	HEX NUT #10-32 BRASS	42301
17	#10 INTERNAL TOOTH WASHER	12573
18	TERMINAL ASSEMBLY	42305
19	SLIP RING STUD	42127
20	SLIP RING MACHINED	42126HD
21	LOWER SPINNER HEAD 1/2	42281
22	SET SCREW 1/4-20 X 3/8 (2 required for the Lower Spinner Head)	74125
23	BOTTOM PHENOLIC WASHER	20054



## 5" Ribbon Spinner Head (Model No. 42283) – Parts List

Item	Part Description	Part Number
		42283
1	LEATHER FLOATER	20010
2	SCREW 8-32 X 5/16 PH PAN MS	89247
3	HIGH CAPACITY SPINNER CAP	43166
4	10-24 X 2 PHIL/SLT MS	42041
5	5 1/2 FLOSS BAND	43165
6	11 OHM RIBBON ASSEMBLY	42251
7	1/4 - 20 NYLON ACORN NUT	48041
8	1/4 - 20 SERRATED LOCK NUT	46311
9	PHENOLIC TERMINAL GUARD	42162
10	8-32X1/2 FL HD PH MS	20066
11	BALANCE WEIGHT	43422
12	8-32 X 1/4 HX HD WHIZ LOCK	42045
13	SPINNER HEAD BOTTOM (Complete assembly includes 2 element lead screws, Terminal Guard, Nylon Nut, Lock Nut, and items listed below.)	42284
14	UPPER SPINNER HEAD	42437
15	1/4-20 X 2-3/4 SET SCREW	42413
16	HEX NUT #10-32 BRASS	42301
17	#10 INTERNAL TOOTH WASHER	12573
18	TERMINAL ASSEMBLY	42305
19	SLIP RING STUD	42127
20	SLIP RING MACHINED	42126HD
21	LOWER SPINNER HEAD 1/2	42281
22	SET SCREW 1/4-20 X 3/8 (2 required for the Lower Spinner Head)	74125
23	BOTTOM PHENOLIC WASHER	20054



## 5" Ribbon Spinner Head (Model No. 42283) – Parts List

Item	Part Description	Part Number
		42283
1	LEATHER FLOATER	20010
2	SCREW 8-32 X 5/16 PH PAN MS	89247
3	HIGH CAPACITY SPINNER CAP	43166
4	10-24 X 2 PHIL/SLT MS	42041
5	5 1/2 FLOSS BAND	43165
6	11 OHM RIBBON ASSEMBLY	42251
7	1/4 - 20 NYLON ACORN NUT	48041
8	1/4 - 20 SERRATED LOCK NUT	46311
9	PHENOLIC TERMINAL GUARD	42162
10	8-32X1/2 FL HD PH MS	20066
11	BALANCE WEIGHT	43422
12	8-32 X 1/4 HX HD WHIZ LOCK	42045
13	SPINNER HEAD BOTTOM (Complete assembly includes 2 element lead screws, Terminal Guard, Nylon Nut, Lock Nut, and items listed below.)	42284
14	UPPER SPINNER HEAD	42437
15	1/4-20 X 2-3/4 SET SCREW	42413
16	HEX NUT #10-32 BRASS	42301
17	#10 INTERNAL TOOTH WASHER	12573
18	TERMINAL ASSEMBLY	42305
19	SLIP RING STUD	42127
20	SLIP RING MACHINED	42126HD
21	LOWER SPINNER HEAD 1/2	42281
22	SET SCREW 1/4-20 X 3/8 (2 required for the Lower Spinner Head)	74125
23	BOTTOM PHENOLIC WASHER	20054



## 5" Ribbon Spinner Head (Model No. 42283) – Parts List

Item	Part Description	Part Number
		42283
1	LEATHER FLOATER	20010
2	SCREW 8-32 X 5/16 PH PAN MS	89247
3	HIGH CAPACITY SPINNER CAP	43166
4	10-24 X 2 PHIL/SLT MS	42041
5	5 1/2 FLOSS BAND	43165
6	11 OHM RIBBON ASSEMBLY	42251
7	1/4 - 20 NYLON ACORN NUT	48041
8	1/4 - 20 SERRATED LOCK NUT	46311
9	PHENOLIC TERMINAL GUARD	42162
10	8-32X1/2 FL HD PH MS	20066
11	BALANCE WEIGHT	43422
12	8-32 X 1/4 HX HD WHIZ LOCK	42045
13	SPINNER HEAD BOTTOM (Complete assembly includes 2 element lead screws, Terminal Guard, Nylon Nut, Lock Nut, and items listed below.)	42284
14	UPPER SPINNER HEAD	42437
15	1/4-20 X 2-3/4 SET SCREW	42413
16	HEX NUT #10-32 BRASS	42301
17	#10 INTERNAL TOOTH WASHER	12573
18	TERMINAL ASSEMBLY	42305
19	SLIP RING STUD	42127
20	SLIP RING MACHINED	42126HD
21	LOWER SPINNER HEAD 1/2	42281
22	SET SCREW 1/4-20 X 3/8 (2 required for the Lower Spinner Head)	74125
23	BOTTOM PHENOLIC WASHER	20054



## 5" Ribbon Spinner Head (Model No. 42283) – Parts List

Item	Part Description	Part Number
		42283
1	LEATHER FLOATER	20010
2	SCREW 8-32 X 5/16 PH PAN MS	89247
3	HIGH CAPACITY SPINNER CAP	43166
4	10-24 X 2 PHIL/SLT MS	42041
5	5 1/2 FLOSS BAND	43165
6	11 OHM RIBBON ASSEMBLY	42251
7	1/4 - 20 NYLON ACORN NUT	48041
8	1/4 - 20 SERRATED LOCK NUT	46311
9	PHENOLIC TERMINAL GUARD	42162
10	8-32X1/2 FL HD PH MS	20066
11	BALANCE WEIGHT	43422
12	8-32 X 1/4 HX HD WHIZ LOCK	42045
13	SPINNER HEAD BOTTOM (Complete assembly includes 2 element lead screws, Terminal Guard, Nylon Nut, Lock Nut, and items listed below.)	42284
14	UPPER SPINNER HEAD	42437
15	1/4-20 X 2-3/4 SET SCREW	42413
16	HEX NUT #10-32 BRASS	42301
17	#10 INTERNAL TOOTH WASHER	12573
18	TERMINAL ASSEMBLY	42305
19	SLIP RING STUD	42127
20	SLIP RING MACHINED	42126HD
21	LOWER SPINNER HEAD 1/2	42281
22	SET SCREW 1/4-20 X 3/8 (2 required for the Lower Spinner Head)	74125
23	BOTTOM PHENOLIC WASHER	20054



## 5" Ribbon Spinner Head (Model No. 42283) – Parts List

Item	Part Description	Part Number
		42283
1	LEATHER FLOATER	20010
2	SCREW 8-32 X 5/16 PH PAN MS	89247
3	HIGH CAPACITY SPINNER CAP	43166
4	10-24 X 2 PHIL/SLT MS	42041
5	5 1/2 FLOSS BAND	43165
6	11 OHM RIBBON ASSEMBLY	42251
7	1/4 - 20 NYLON ACORN NUT	48041
8	1/4 - 20 SERRATED LOCK NUT	46311
9	PHENOLIC TERMINAL GUARD	42162
10	8-32X1/2 FL HD PH MS	20066
11	BALANCE WEIGHT	43422
12	8-32 X 1/4 HX HD WHIZ LOCK	42045
13	SPINNER HEAD BOTTOM (Complete assembly includes 2 element lead screws, Terminal Guard, Nylon Nut, Lock Nut, and items listed below.)	42284
14	UPPER SPINNER HEAD	42437
15	1/4-20 X 2-3/4 SET SCREW	42413
16	HEX NUT #10-32 BRASS	42301
17	#10 INTERNAL TOOTH WASHER	12573
18	TERMINAL ASSEMBLY	42305
19	SLIP RING STUD	42127
20	SLIP RING MACHINED	42126HD
21	LOWER SPINNER HEAD 1/2	42281
22	SET SCREW 1/4-20 X 3/8 (2 required for the Lower Spinner Head)	74125
23	BOTTOM PHENOLIC WASHER	20054



## 5" Ribbon Spinner Head (Model No. 42283) – Parts List

Item	Part Description	Part Number
		42283
1	LEATHER FLOATER	20010
2	SCREW 8-32 X 5/16 PH PAN MS	89247
3	HIGH CAPACITY SPINNER CAP	43166
4	10-24 X 2 PHIL/SLT MS	42041
5	5 1/2 FLOSS BAND	43165
6	11 OHM RIBBON ASSEMBLY	42251
7	1/4 - 20 NYLON ACORN NUT	48041
8	1/4 - 20 SERRATED LOCK NUT	46311
9	PHENOLIC TERMINAL GUARD	42162
10	8-32X1/2 FL HD PH MS	20066
11	BALANCE WEIGHT	43422
12	8-32 X 1/4 HX HD WHIZ LOCK	42045
13	SPINNER HEAD BOTTOM (Complete assembly includes 2 element lead screws, Terminal Guard, Nylon Nut, Lock Nut, and items listed below.)	42284
14	UPPER SPINNER HEAD	42437
15	1/4-20 X 2-3/4 SET SCREW	42413
16	HEX NUT #10-32 BRASS	42301
17	#10 INTERNAL TOOTH WASHER	12573
18	TERMINAL ASSEMBLY	42305
19	SLIP RING STUD	42127
20	SLIP RING MACHINED	42126HD
21	LOWER SPINNER HEAD 1/2	42281
22	SET SCREW 1/4-20 X 3/8 (2 required for the Lower Spinner Head)	74125
23	BOTTOM PHENOLIC WASHER	20054



## 5" Ribbon Spinner Head (Model No. 42283) – Parts List

Item	Part Description	Part Number
		42283
1	LEATHER FLOATER	20010
2	SCREW 8-32 X 5/16 PH PAN MS	89247
3	HIGH CAPACITY SPINNER CAP	43166
4	10-24 X 2 PHIL/SLT MS	42041
5	5 1/2 FLOSS BAND	43165
6	11 OHM RIBBON ASSEMBLY	42251
7	1/4 - 20 NYLON ACORN NUT	48041
8	1/4 - 20 SERRATED LOCK NUT	46311
9	PHENOLIC TERMINAL GUARD	42162
10	8-32X1/2 FL HD PH MS	20066
11	BALANCE WEIGHT	43422
12	8-32 X 1/4 HX HD WHIZ LOCK	42045
13	SPINNER HEAD BOTTOM (Complete assembly includes 2 element lead screws, Terminal Guard, Nylon Nut, Lock Nut, and items listed below.)	42284
14	UPPER SPINNER HEAD	42437
15	1/4-20 X 2-3/4 SET SCREW	42413
16	HEX NUT #10-32 BRASS	42301
17	#10 INTERNAL TOOTH WASHER	12573
18	TERMINAL ASSEMBLY	42305
19	SLIP RING STUD	42127
20	SLIP RING MACHINED	42126HD
21	LOWER SPINNER HEAD 1/2	42281
22	SET SCREW 1/4-20 X 3/8 (2 required for the Lower Spinner Head)	74125
23	BOTTOM PHENOLIC WASHER	20054



## 5" Ribbon Spinner Head (Model No. 42283) – Parts List

Item	Part Description	Part Number
		42283
1	LEATHER FLOATER	20010
2	SCREW 8-32 X 5/16 PH PAN MS	89247
3	HIGH CAPACITY SPINNER CAP	43166
4	10-24 X 2 PHIL/SLT MS	42041
5	5 1/2 FLOSS BAND	43165
6	11 OHM RIBBON ASSEMBLY	42251
7	1/4 - 20 NYLON ACORN NUT	48041
8	1/4 - 20 SERRATED LOCK NUT	46311
9	PHENOLIC TERMINAL GUARD	42162
10	8-32X1/2 FL HD PH MS	20066
11	BALANCE WEIGHT	43422
12	8-32 X 1/4 HX HD WHIZ LOCK	42045
13	SPINNER HEAD BOTTOM (Complete assembly includes 2 element lead screws, Terminal Guard, Nylon Nut, Lock Nut, and items listed below.)	42284
14	UPPER SPINNER HEAD	42437
15	1/4-20 X 2-3/4 SET SCREW	42413
16	HEX NUT #10-32 BRASS	42301
17	#10 INTERNAL TOOTH WASHER	12573
18	TERMINAL ASSEMBLY	42305
19	SLIP RING STUD	42127
20	SLIP RING MACHINED	42126HD
21	LOWER SPINNER HEAD 1/2	42281
22	SET SCREW 1/4-20 X 3/8 (2 required for the Lower Spinner Head)	74125
23	BOTTOM PHENOLIC WASHER	20054



## 5" Ribbon Spinner Head (Model No. 42283) – Parts List

Item	Part Description	Part Number
		42283
1	LEATHER FLOATER	20010
2	SCREW 8-32 X 5/16 PH PAN MS	89247
3	HIGH CAPACITY SPINNER CAP	43166
4	10-24 X 2 PHIL/SLT MS	42041
5	5 1/2 FLOSS BAND	43165
6	11 OHM RIBBON ASSEMBLY	42251
7	1/4 - 20 NYLON ACORN NUT	48041
8	1/4 - 20 SERRATED LOCK NUT	46311
9	PHENOLIC TERMINAL GUARD	42162
10	8-32X1/2 FL HD PH MS	20066
11	BALANCE WEIGHT	43422
12	8-32 X 1/4 HX HD WHIZ LOCK	42045
13	SPINNER HEAD BOTTOM (Complete assembly includes 2 element lead screws, Terminal Guard, Nylon Nut, Lock Nut, and items listed below.)	42284
14	UPPER SPINNER HEAD	42437
15	1/4-20 X 2-3/4 SET SCREW	42413
16	HEX NUT #10-32 BRASS	42301
17	#10 INTERNAL TOOTH WASHER	12573
18	TERMINAL ASSEMBLY	42305
19	SLIP RING STUD	42127
20	SLIP RING MACHINED	42126HD
21	LOWER SPINNER HEAD 1/2	42281
22	SET SCREW 1/4-20 X 3/8 (2 required for the Lower Spinner Head)	74125
23	BOTTOM PHENOLIC WASHER	20054



## 5" Ribbon Spinner Head (Model No. 42283) – Parts List

Item	Part Description	Part Number
		42283
1	LEATHER FLOATER	20010
2	SCREW 8-32 X 5/16 PH PAN MS	89247
3	HIGH CAPACITY SPINNER CAP	43166
4	10-24 X 2 PHIL/SLT MS	42041
5	5 1/2 FLOSS BAND	43165
6	11 OHM RIBBON ASSEMBLY	42251
7	1/4 - 20 NYLON ACORN NUT	48041
8	1/4 - 20 SERRATED LOCK NUT	46311
9	PHENOLIC TERMINAL GUARD	42162
10	8-32X1/2 FL HD PH MS	20066
11	BALANCE WEIGHT	43422
12	8-32 X 1/4 HX HD WHIZ LOCK	42045
13	SPINNER HEAD BOTTOM (Complete assembly includes 2 element lead screws, Terminal Guard, Nylon Nut, Lock Nut, and items listed below.)	42284
14	UPPER SPINNER HEAD	42437
15	1/4-20 X 2-3/4 SET SCREW	42413
16	HEX NUT #10-32 BRASS	42301
17	#10 INTERNAL TOOTH WASHER	12573
18	TERMINAL ASSEMBLY	42305
19	SLIP RING STUD	42127
20	SLIP RING MACHINED	42126HD
21	LOWER SPINNER HEAD 1/2	42281
22	SET SCREW 1/4-20 X 3/8 (2 required for the Lower Spinner Head)	74125
23	BOTTOM PHENOLIC WASHER	20054



## 5" Ribbon Spinner Head (Model No. 42283) – Parts List

Item	Part Description	Part Number
		42283
1	LEATHER FLOATER	20010
2	SCREW 8-32 X 5/16 PH PAN MS	89247
3	HIGH CAPACITY SPINNER CAP	43166
4	10-24 X 2 PHIL/SLT MS	42041
5	5 1/2 FLOSS BAND	43165
6	11 OHM RIBBON ASSEMBLY	42251
7	1/4 - 20 NYLON ACORN NUT	48041
8	1/4 - 20 SERRATED LOCK NUT	46311
9	PHENOLIC TERMINAL GUARD	42162
10	8-32X1/2 FL HD PH MS	20066
11	BALANCE WEIGHT	43422
12	8-32 X 1/4 HX HD WHIZ LOCK	42045
13	SPINNER HEAD BOTTOM (Complete assembly includes 2 element lead screws, Terminal Guard, Nylon Nut, Lock Nut, and items listed below.)	42284
14	UPPER SPINNER HEAD	42437
15	1/4-20 X 2-3/4 SET SCREW	42413
16	HEX NUT #10-32 BRASS	42301
17	#10 INTERNAL TOOTH WASHER	12573
18	TERMINAL ASSEMBLY	42305
19	SLIP RING STUD	42127
20	SLIP RING MACHINED	42126HD
21	LOWER SPINNER HEAD 1/2	42281
22	SET SCREW 1/4-20 X 3/8 (2 required for the Lower Spinner Head)	74125
23	BOTTOM PHENOLIC WASHER	20054



## 5" Ribbon Spinner Head (Model No. 42283) – Parts List

Item	Part Description	Part Number
		42283
1	LEATHER FLOATER	20010
2	SCREW 8-32 X 5/16 PH PAN MS	89247
3	HIGH CAPACITY SPINNER CAP	43166
4	10-24 X 2 PHIL/SLT MS	42041
5	5 1/2 FLOSS BAND	43165
6	11 OHM RIBBON ASSEMBLY	42251
7	1/4 - 20 NYLON ACORN NUT	48041
8	1/4 - 20 SERRATED LOCK NUT	46311
9	PHENOLIC TERMINAL GUARD	42162
10	8-32X1/2 FL HD PH MS	20066
11	BALANCE WEIGHT	43422
12	8-32 X 1/4 HX HD WHIZ LOCK	42045
13	SPINNER HEAD BOTTOM (Complete assembly includes 2 element lead screws, Terminal Guard, Nylon Nut, Lock Nut, and items listed below.)	42284
14	UPPER SPINNER HEAD	42437
15	1/4-20 X 2-3/4 SET SCREW	42413
16	HEX NUT #10-32 BRASS	42301
17	#10 INTERNAL TOOTH WASHER	12573
18	TERMINAL ASSEMBLY	42305
19	SLIP RING STUD	42127
20	SLIP RING MACHINED	42126HD
21	LOWER SPINNER HEAD 1/2	42281
22	SET SCREW 1/4-20 X 3/8 (2 required for the Lower Spinner Head)	74125
23	BOTTOM PHENOLIC WASHER	20054



## 5" Ribbon Spinner Head (Model No. 42283) – Parts List

Item	Part Description	Part Number
		42283
1	LEATHER FLOATER	20010
2	SCREW 8-32 X 5/16 PH PAN MS	89247
3	HIGH CAPACITY SPINNER CAP	43166
4	10-24 X 2 PHIL/SLT MS	42041
5	5 1/2 FLOSS BAND	43165
6	11 OHM RIBBON ASSEMBLY	42251
7	1/4 - 20 NYLON ACORN NUT	48041
8	1/4 - 20 SERRATED LOCK NUT	46311
9	PHENOLIC TERMINAL GUARD	42162
10	8-32X1/2 FL HD PH MS	20066
11	BALANCE WEIGHT	43422
12	8-32 X 1/4 HX HD WHIZ LOCK	42045
13	SPINNER HEAD BOTTOM (Complete assembly includes 2 element lead screws, Terminal Guard, Nylon Nut, Lock Nut, and items listed below.)	42284
14	UPPER SPINNER HEAD	42437
15	1/4-20 X 2-3/4 SET SCREW	42413
16	HEX NUT #10-32 BRASS	42301
17	#10 INTERNAL TOOTH WASHER	12573
18	TERMINAL ASSEMBLY	42305
19	SLIP RING STUD	42127
20	SLIP RING MACHINED	42126HD
21	LOWER SPINNER HEAD 1/2	42281
22	SET SCREW 1/4-20 X 3/8 (2 required for the Lower Spinner Head)	74125
23	BOTTOM PHENOLIC WASHER	20054



## 5" Ribbon Spinner Head (Model No. 42283) – Parts List

Item	Part Description	Part Number
		42283
1	LEATHER FLOATER	20010
2	SCREW 8-32 X 5/16 PH PAN MS	89247
3	HIGH CAPACITY SPINNER CAP	43166
4	10-24 X 2 PHIL/SLT MS	42041
5	5 1/2 FLOSS BAND	43165
6	11 OHM RIBBON ASSEMBLY	42251
7	1/4 - 20 NYLON ACORN NUT	48041
8	1/4 - 20 SERRATED LOCK NUT	46311
9	PHENOLIC TERMINAL GUARD	42162
10	8-32X1/2 FL HD PH MS	20066
11	BALANCE WEIGHT	43422
12	8-32 X 1/4 HX HD WHIZ LOCK	42045
13	SPINNER HEAD BOTTOM (Complete assembly includes 2 element lead screws, Terminal Guard, Nylon Nut, Lock Nut, and items listed below.)	42284
14	UPPER SPINNER HEAD	42437
15	1/4-20 X 2-3/4 SET SCREW	42413
16	HEX NUT #10-32 BRASS	42301
17	#10 INTERNAL TOOTH WASHER	12573
18	TERMINAL ASSEMBLY	42305
19	SLIP RING STUD	42127
20	SLIP RING MACHINED	42126HD
21	LOWER SPINNER HEAD 1/2	42281
22	SET SCREW 1/4-20 X 3/8 (2 required for the Lower Spinner Head)	74125
23	BOTTOM PHENOLIC WASHER	20054



## 5" Ribbon Spinner Head (Model No. 42283) – Parts List

Item	Part Description	Part Number
		42283
1	LEATHER FLOATER	20010
2	SCREW 8-32 X 5/16 PH PAN MS	89247
3	HIGH CAPACITY SPINNER CAP	43166
4	10-24 X 2 PHIL/SLT MS	42041
5	5 1/2 FLOSS BAND	43165
6	11 OHM RIBBON ASSEMBLY	42251
7	1/4 - 20 NYLON ACORN NUT	48041
8	1/4 - 20 SERRATED LOCK NUT	46311
9	PHENOLIC TERMINAL GUARD	42162
10	8-32X1/2 FL HD PH MS	20066
11	BALANCE WEIGHT	43422
12	8-32 X 1/4 HX HD WHIZ LOCK	42045
13	SPINNER HEAD BOTTOM (Complete assembly includes 2 element lead screws, Terminal Guard, Nylon Nut, Lock Nut, and items listed below.)	42284
14	UPPER SPINNER HEAD	42437
15	1/4-20 X 2-3/4 SET SCREW	42413
16	HEX NUT #10-32 BRASS	42301
17	#10 INTERNAL TOOTH WASHER	12573
18	TERMINAL ASSEMBLY	42305
19	SLIP RING STUD	42127
20	SLIP RING MACHINED	42126HD
21	LOWER SPINNER HEAD 1/2	42281
22	SET SCREW 1/4-20 X 3/8 (2 required for the Lower Spinner Head)	74125
23	BOTTOM PHENOLIC WASHER	20054



## 5" Ribbon Spinner Head (Model No. 42283) – Parts List

Item	Part Description	Part Number
		42283
1	LEATHER FLOATER	20010
2	SCREW 8-32 X 5/16 PH PAN MS	89247
3	HIGH CAPACITY SPINNER CAP	43166
4	10-24 X 2 PHIL/SLT MS	42041
5	5 1/2 FLOSS BAND	43165
6	11 OHM RIBBON ASSEMBLY	42251
7	1/4 - 20 NYLON ACORN NUT	48041
8	1/4 - 20 SERRATED LOCK NUT	46311
9	PHENOLIC TERMINAL GUARD	42162
10	8-32X1/2 FL HD PH MS	20066
11	BALANCE WEIGHT	43422
12	8-32 X 1/4 HX HD WHIZ LOCK	42045
13	SPINNER HEAD BOTTOM (Complete assembly includes 2 element lead screws, Terminal Guard, Nylon Nut, Lock Nut, and items listed below.)	42284
14	UPPER SPINNER HEAD	42437
15	1/4-20 X 2-3/4 SET SCREW	42413
16	HEX NUT #10-32 BRASS	42301
17	#10 INTERNAL TOOTH WASHER	12573
18	TERMINAL ASSEMBLY	42305
19	SLIP RING STUD	42127
20	SLIP RING MACHINED	42126HD
21	LOWER SPINNER HEAD 1/2	42281
22	SET SCREW 1/4-20 X 3/8 (2 required for the Lower Spinner Head)	74125
23	BOTTOM PHENOLIC WASHER	20054



## 5" Ribbon Spinner Head (Model No. 42283) – Parts List

Item	Part Description	Part Number
		42283
1	LEATHER FLOATER	20010
2	SCREW 8-32 X 5/16 PH PAN MS	89247
3	HIGH CAPACITY SPINNER CAP	43166
4	10-24 X 2 PHIL/SLT MS	42041
5	5 1/2 FLOSS BAND	43165
6	11 OHM RIBBON ASSEMBLY	42251
7	1/4 - 20 NYLON ACORN NUT	48041
8	1/4 - 20 SERRATED LOCK NUT	46311
9	PHENOLIC TERMINAL GUARD	42162
10	8-32X1/2 FL HD PH MS	20066
11	BALANCE WEIGHT	43422
12	8-32 X 1/4 HX HD WHIZ LOCK	42045
13	SPINNER HEAD BOTTOM (Complete assembly includes 2 element lead screws, Terminal Guard, Nylon Nut, Lock Nut, and items listed below.)	42284
14	UPPER SPINNER HEAD	42437
15	1/4-20 X 2-3/4 SET SCREW	42413
16	HEX NUT #10-32 BRASS	42301
17	#10 INTERNAL TOOTH WASHER	12573
18	TERMINAL ASSEMBLY	42305
19	SLIP RING STUD	42127
20	SLIP RING MACHINED	42126HD
21	LOWER SPINNER HEAD 1/2	42281
22	SET SCREW 1/4-20 X 3/8 (2 required for the Lower Spinner Head)	74125
23	BOTTOM PHENOLIC WASHER	20054



## 5" Ribbon Spinner Head (Model No. 42283) – Parts List

Item	Part Description	Part Number
		42283
1	LEATHER FLOATER	20010
2	SCREW 8-32 X 5/16 PH PAN MS	89247
3	HIGH CAPACITY SPINNER CAP	43166
4	10-24 X 2 PHIL/SLT MS	42041
5	5 1/2 FLOSS BAND	43165
6	11 OHM RIBBON ASSEMBLY	42251
7	1/4 - 20 NYLON ACORN NUT	48041
8	1/4 - 20 SERRATED LOCK NUT	46311
9	PHENOLIC TERMINAL GUARD	42162
10	8-32X1/2 FL HD PH MS	20066
11	BALANCE WEIGHT	43422
12	8-32 X 1/4 HX HD WHIZ LOCK	42045
13	SPINNER HEAD BOTTOM (Complete assembly includes 2 element lead screws, Terminal Guard, Nylon Nut, Lock Nut, and items listed below.)	42284
14	UPPER SPINNER HEAD	42437
15	1/4-20 X 2-3/4 SET SCREW	42413
16	HEX NUT #10-32 BRASS	42301
17	#10 INTERNAL TOOTH WASHER	12573
18	TERMINAL ASSEMBLY	42305
19	SLIP RING STUD	42127
20	SLIP RING MACHINED	42126HD
21	LOWER SPINNER HEAD 1/2	42281
22	SET SCREW 1/4-20 X 3/8 (2 required for the Lower Spinner Head)	74125
23	BOTTOM PHENOLIC WASHER	20054



## 5" Ribbon Spinner Head (Model No. 42283) – Parts List

Item	Part Description	Part Number
		42283
1	LEATHER FLOATER	20010
2	SCREW 8-32 X 5/16 PH PAN MS	89247
3	HIGH CAPACITY SPINNER CAP	43166
4	10-24 X 2 PHIL/SLT MS	42041
5	5 1/2 FLOSS BAND	43165
6	11 OHM RIBBON ASSEMBLY	42251
7	1/4 - 20 NYLON ACORN NUT	48041
8	1/4 - 20 SERRATED LOCK NUT	46311
9	PHENOLIC TERMINAL GUARD	42162
10	8-32X1/2 FL HD PH MS	20066
11	BALANCE WEIGHT	43422
12	8-32 X 1/4 HX HD WHIZ LOCK	42045
13	SPINNER HEAD BOTTOM (Complete assembly includes 2 element lead screws, Terminal Guard, Nylon Nut, Lock Nut, and items listed below.)	42284
14	UPPER SPINNER HEAD	42437
15	1/4-20 X 2-3/4 SET SCREW	42413
16	HEX NUT #10-32 BRASS	42301
17	#10 INTERNAL TOOTH WASHER	12573
18	TERMINAL ASSEMBLY	42305
19	SLIP RING STUD	42127
20	SLIP RING MACHINED	42126HD
21	LOWER SPINNER HEAD 1/2	42281
22	SET SCREW 1/4-20 X 3/8 (2 required for the Lower Spinner Head)	74125
23	BOTTOM PHENOLIC WASHER	20054



## 5" Ribbon Spinner Head (Model No. 42283) – Parts List

Item	Part Description	Part Number
		42283
1	LEATHER FLOATER	20010
2	SCREW 8-32 X 5/16 PH PAN MS	89247
3	HIGH CAPACITY SPINNER CAP	43166
4	10-24 X 2 PHIL/SLT MS	42041
5	5 1/2 FLOSS BAND	43165
6	11 OHM RIBBON ASSEMBLY	42251
7	1/4 - 20 NYLON ACORN NUT	48041
8	1/4 - 20 SERRATED LOCK NUT	46311
9	PHENOLIC TERMINAL GUARD	42162
10	8-32X1/2 FL HD PH MS	20066
11	BALANCE WEIGHT	43422
12	8-32 X 1/4 HX HD WHIZ LOCK	42045
13	SPINNER HEAD BOTTOM (Complete assembly includes 2 element lead screws, Terminal Guard, Nylon Nut, Lock Nut, and items listed below.)	42284
14	UPPER SPINNER HEAD	42437
15	1/4-20 X 2-3/4 SET SCREW	42413
16	HEX NUT #10-32 BRASS	42301
17	#10 INTERNAL TOOTH WASHER	12573
18	TERMINAL ASSEMBLY	42305
19	SLIP RING STUD	42127
20	SLIP RING MACHINED	42126HD
21	LOWER SPINNER HEAD 1/2	42281
22	SET SCREW 1/4-20 X 3/8 (2 required for the Lower Spinner Head)	74125
23	BOTTOM PHENOLIC WASHER	20054



## Bell Housing Interior – Brush Assembly

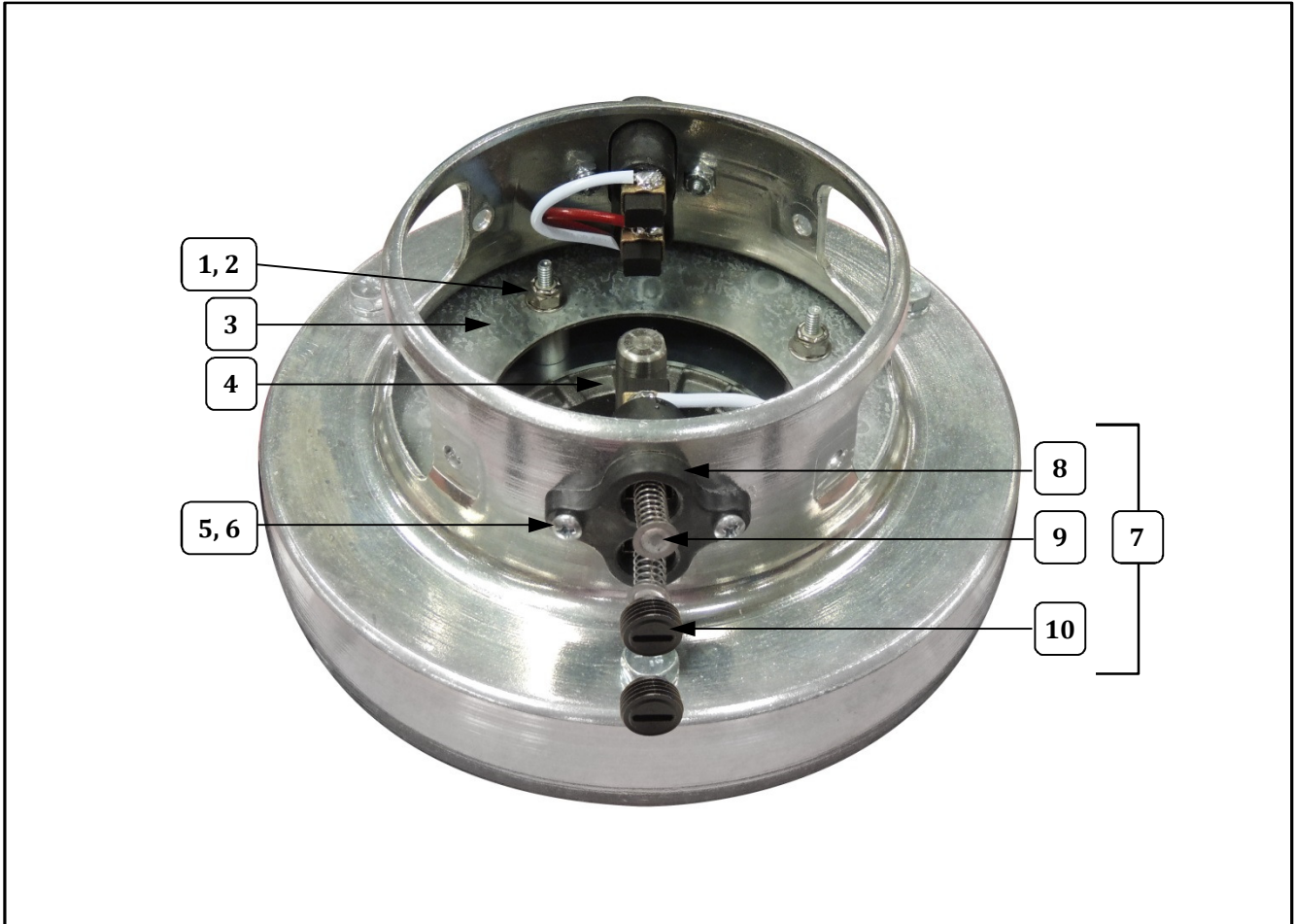

Item	Part Description	Part Number	
		3017-00-000	3024-00-000
1	HEX NUT #10-24 ESLOK	74691	74691
2	.188ID FLATWASHER	77052	77052
3	MOTOR MTG PLATE	42119	42119
4	MOTOR, FLOSS MACHINE	48649	48649
5	6-32 X 1/2 PH PAN HD M/S	47516	47516
6	6-32 GRIP NUT ZINC PLATED	47517	47517
7	BRUSH HOLDER ASSEMBLY (includes Brushes, Caps and Holders)	42382W	42382W
8	DUAL BRUSH HOLDER W/LEADS	42436W	42436W
9	CARBON BRUSH	55007	55007
10	CAP, BRUSH HOLDER	42138	42138



## Bell Housing Interior – Brush Assembly

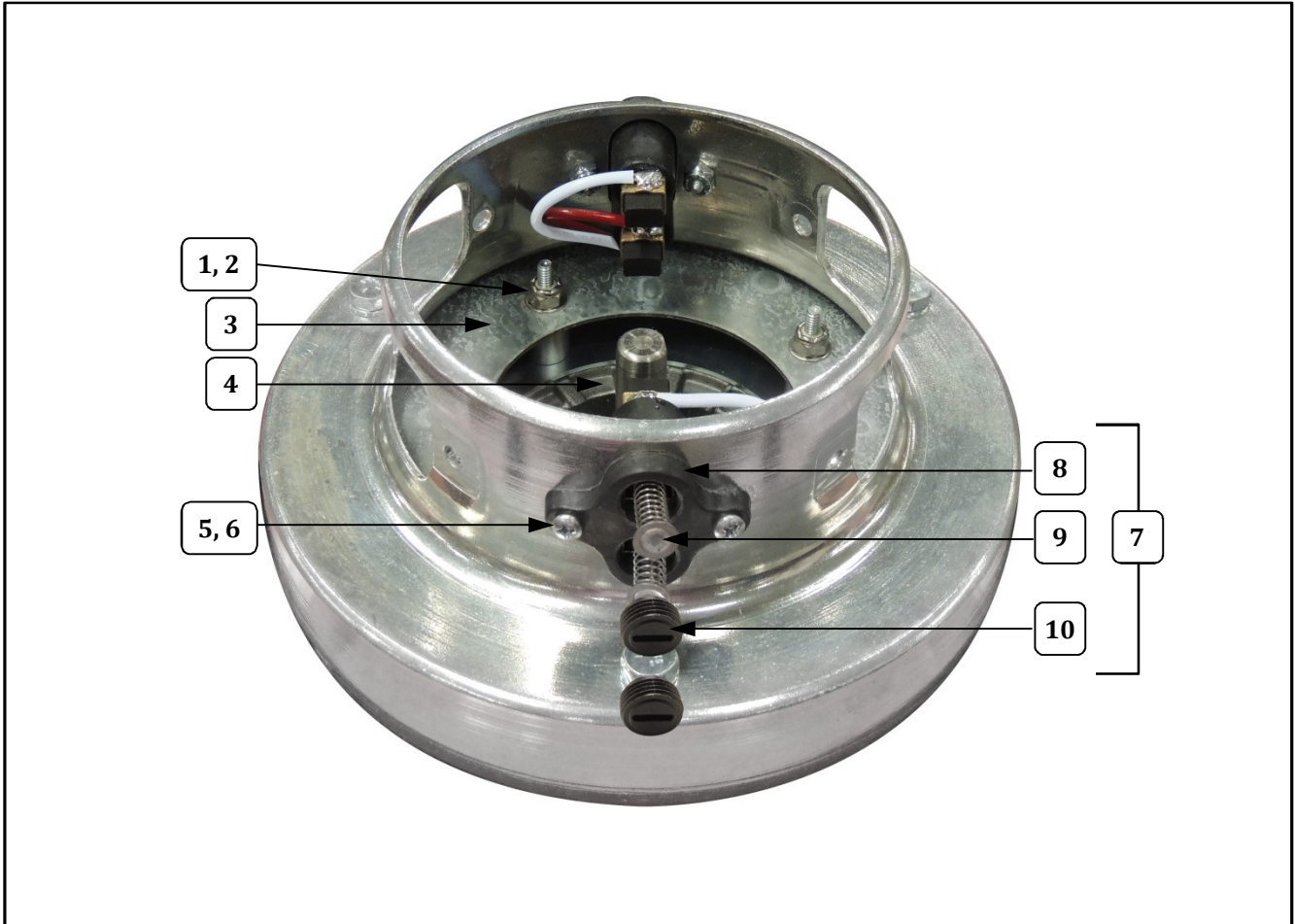

Item	Part Description	Part Number	
		3017-00-000	3024-00-000
1	HEX NUT #10-24 ESLOK	74691	74691
2	.188ID FLATWASHER	77052	77052
3	MOTOR MTG PLATE	42119	42119
4	MOTOR, FLOSS MACHINE	48649	48649
5	6-32 X 1/2 PH PAN HD M/S	47516	47516
6	6-32 GRIP NUT ZINC PLATED	47517	47517
7	BRUSH HOLDER ASSEMBLY (includes Brushes, Caps and Holders)	42382W	42382W
8	DUAL BRUSH HOLDER W/LEADS	42436W	42436W
9	CARBON BRUSH	55007	55007
10	CAP, BRUSH HOLDER	42138	42138



## Bell Housing Interior – Brush Assembly

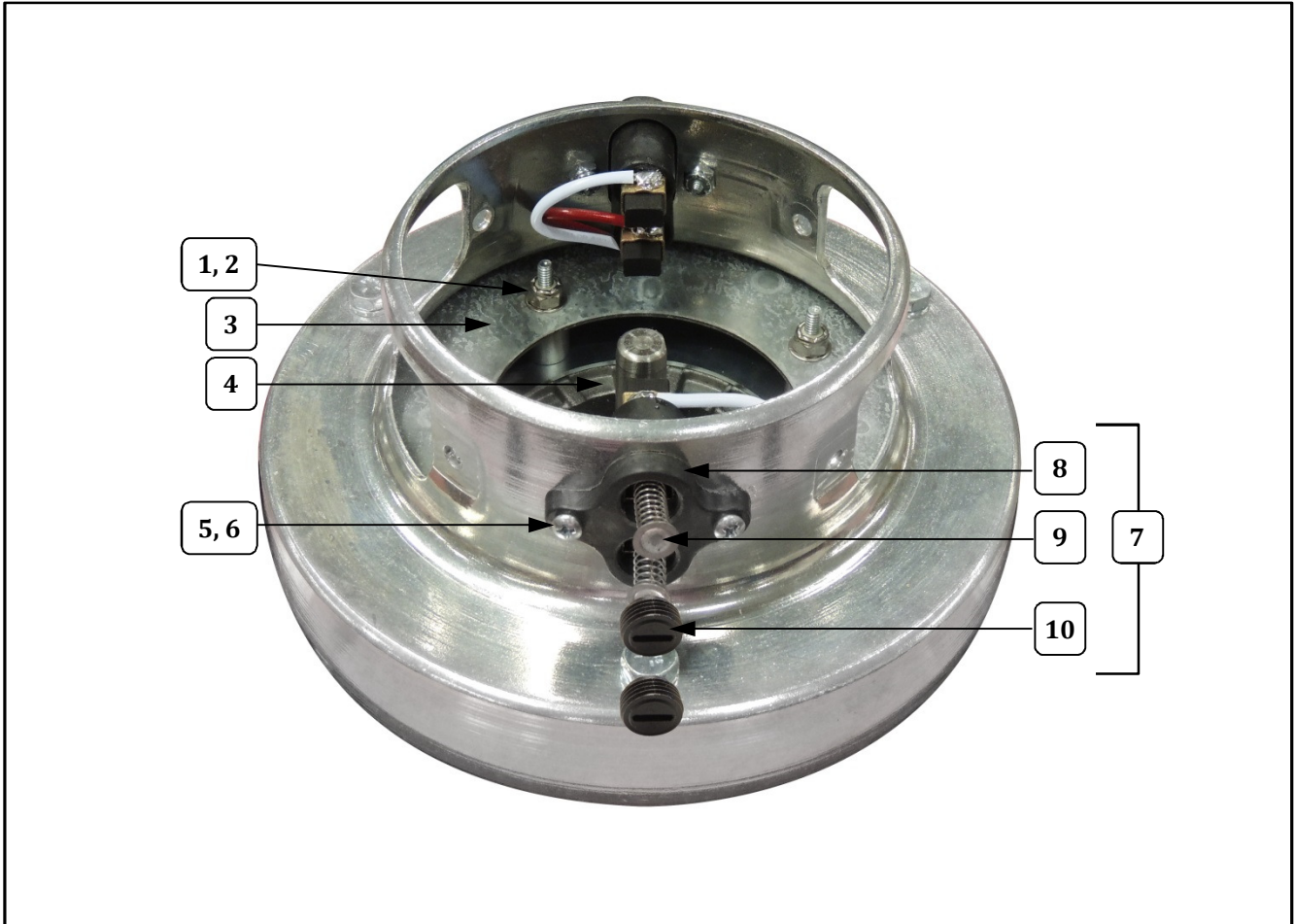

Item	Part Description	Part Number	
		3017-00-000	3024-00-000
1	HEX NUT #10-24 ESLOK	74691	74691
2	.188ID FLATWASHER	77052	77052
3	MOTOR MTG PLATE	42119	42119
4	MOTOR, FLOSS MACHINE	48649	48649
5	6-32 X 1/2 PH PAN HD M/S	47516	47516
6	6-32 GRIP NUT ZINC PLATED	47517	47517
7	BRUSH HOLDER ASSEMBLY (includes Brushes, Caps and Holders)	42382W	42382W
8	DUAL BRUSH HOLDER W/LEADS	42436W	42436W
9	CARBON BRUSH	55007	55007
10	CAP, BRUSH HOLDER	42138	42138



## Bell Housing Interior – Brush Assembly

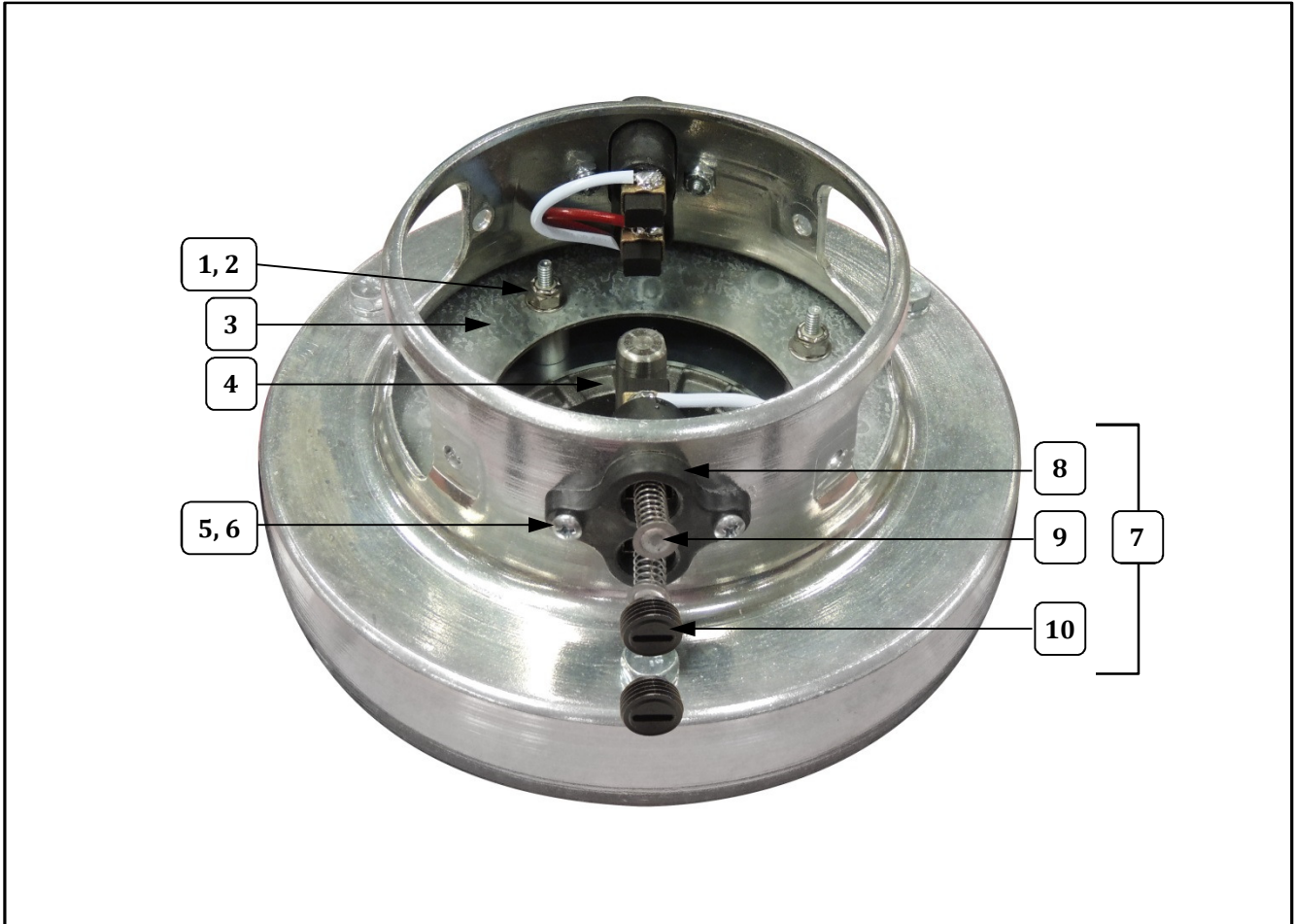

Item	Part Description	Part Number	
		3017-00-000	3024-00-000
1	HEX NUT #10-24 ESLOK	74691	74691
2	.188ID FLATWASHER	77052	77052
3	MOTOR MTG PLATE	42119	42119
4	MOTOR, FLOSS MACHINE	48649	48649
5	6-32 X 1/2 PH PAN HD M/S	47516	47516
6	6-32 GRIP NUT ZINC PLATED	47517	47517
7	BRUSH HOLDER ASSEMBLY (includes Brushes, Caps and Holders)	42382W	42382W
8	DUAL BRUSH HOLDER W/LEADS	42436W	42436W
9	CARBON BRUSH	55007	55007
10	CAP, BRUSH HOLDER	42138	42138



## Bell Housing Interior – Brush Assembly

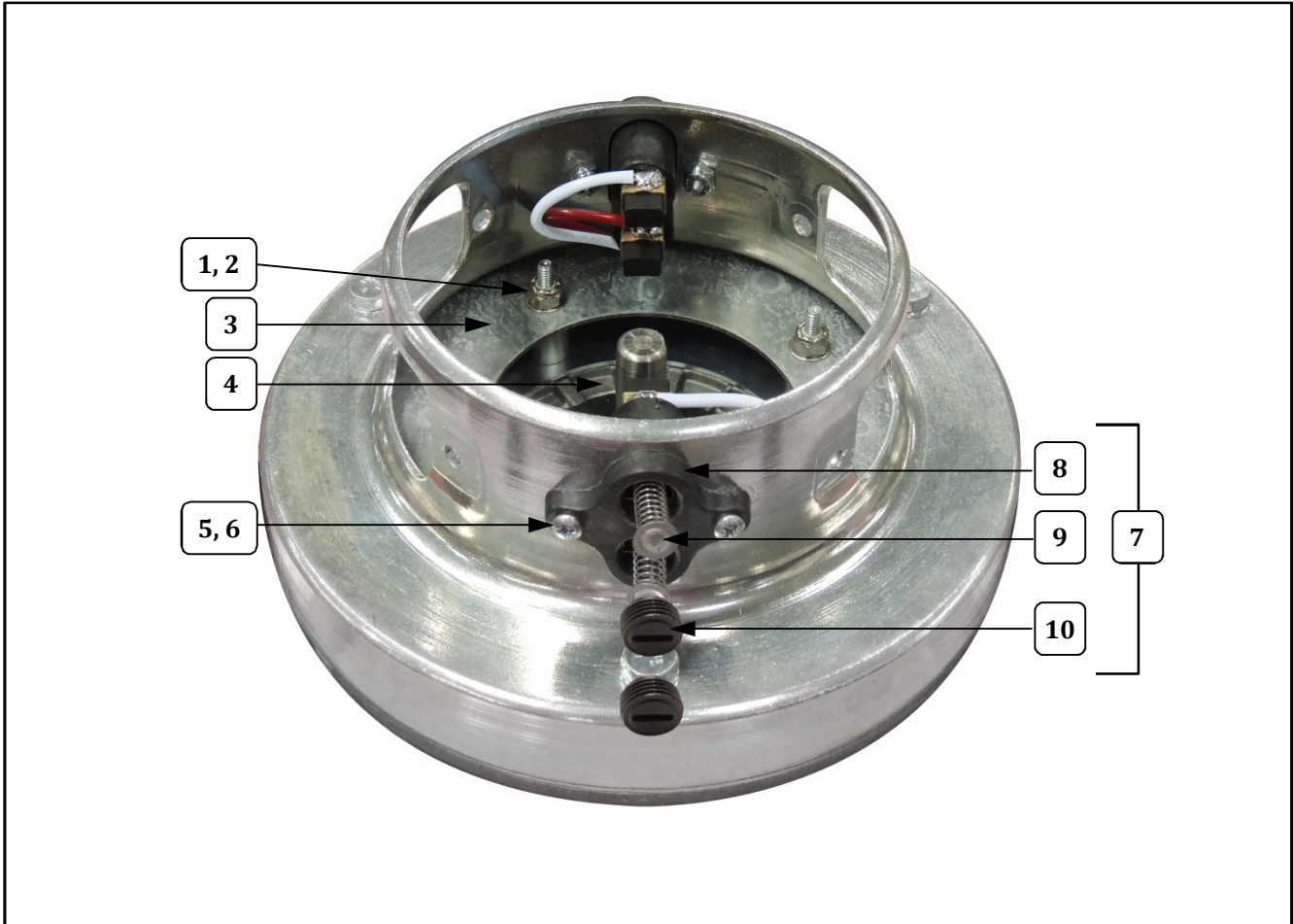

Item	Part Description	Part Number	
		3017-00-000	3024-00-000
1	HEX NUT #10-24 ESLOK	74691	74691
2	.188ID FLATWASHER	77052	77052
3	MOTOR MTG PLATE	42119	42119
4	MOTOR, FLOSS MACHINE	48649	48649
5	6-32 X 1/2 PH PAN HD M/S	47516	47516
6	6-32 GRIP NUT ZINC PLATED	47517	47517
7	BRUSH HOLDER ASSEMBLY (includes Brushes, Caps and Holders)	42382W	42382W
8	DUAL BRUSH HOLDER W/LEADS	42436W	42436W
9	CARBON BRUSH	55007	55007
10	CAP, BRUSH HOLDER	42138	42138



## Bell Housing Interior – Brush Assembly

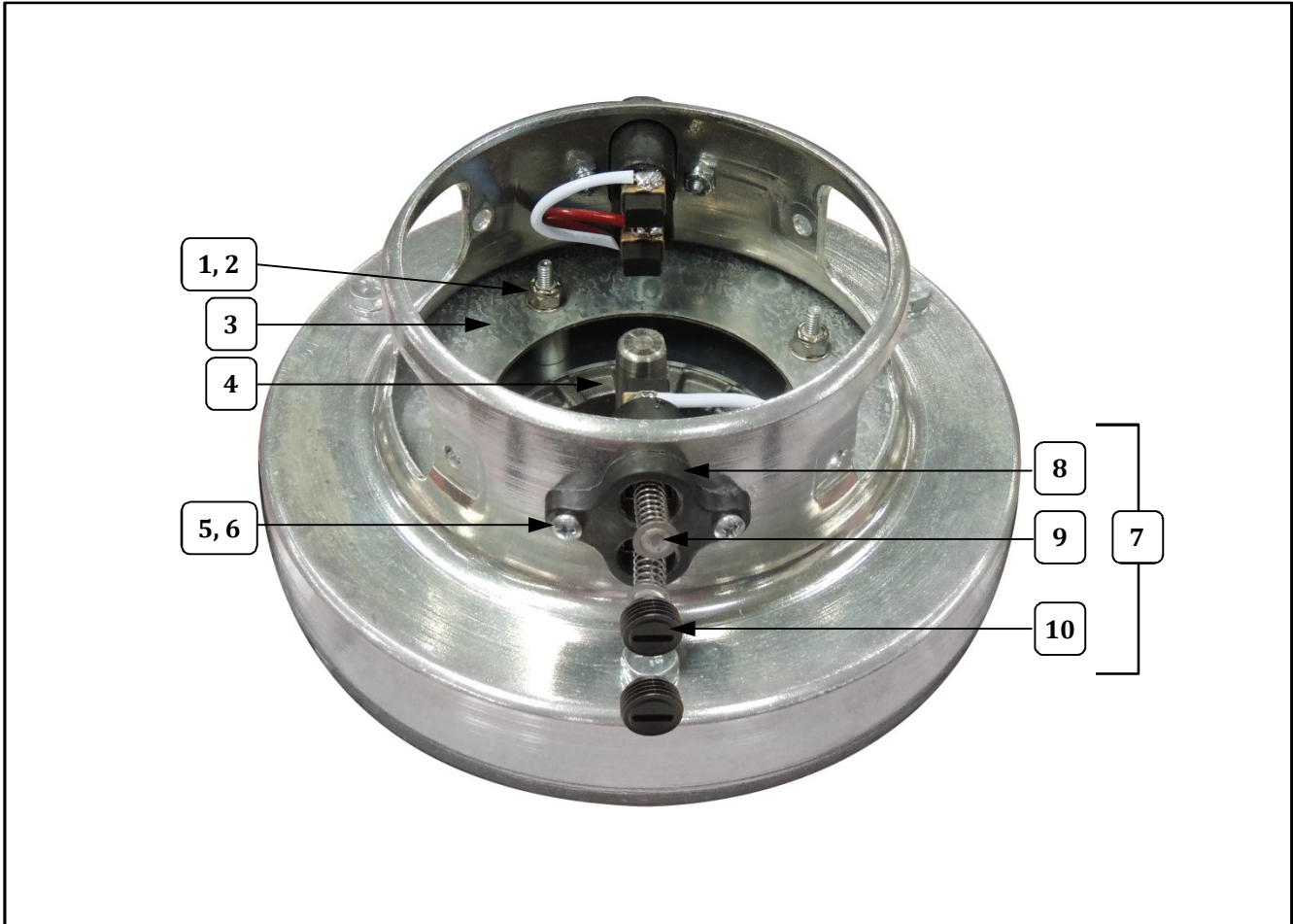

Item	Part Description	Part Number	
		3017-00-000	3024-00-000
1	HEX NUT #10-24 ESLOK	74691	74691
2	.188ID FLATWASHER	77052	77052
3	MOTOR MTG PLATE	42119	42119
4	MOTOR, FLOSS MACHINE	48649	48649
5	6-32 X 1/2 PH PAN HD M/S	47516	47516
6	6-32 GRIP NUT ZINC PLATED	47517	47517
7	BRUSH HOLDER ASSEMBLY (includes Brushes, Caps and Holders)	42382W	42382W
8	DUAL BRUSH HOLDER W/LEADS	42436W	42436W
9	CARBON BRUSH	55007	55007
10	CAP, BRUSH HOLDER	42138	42138



## Bell Housing Interior – Brush Assembly

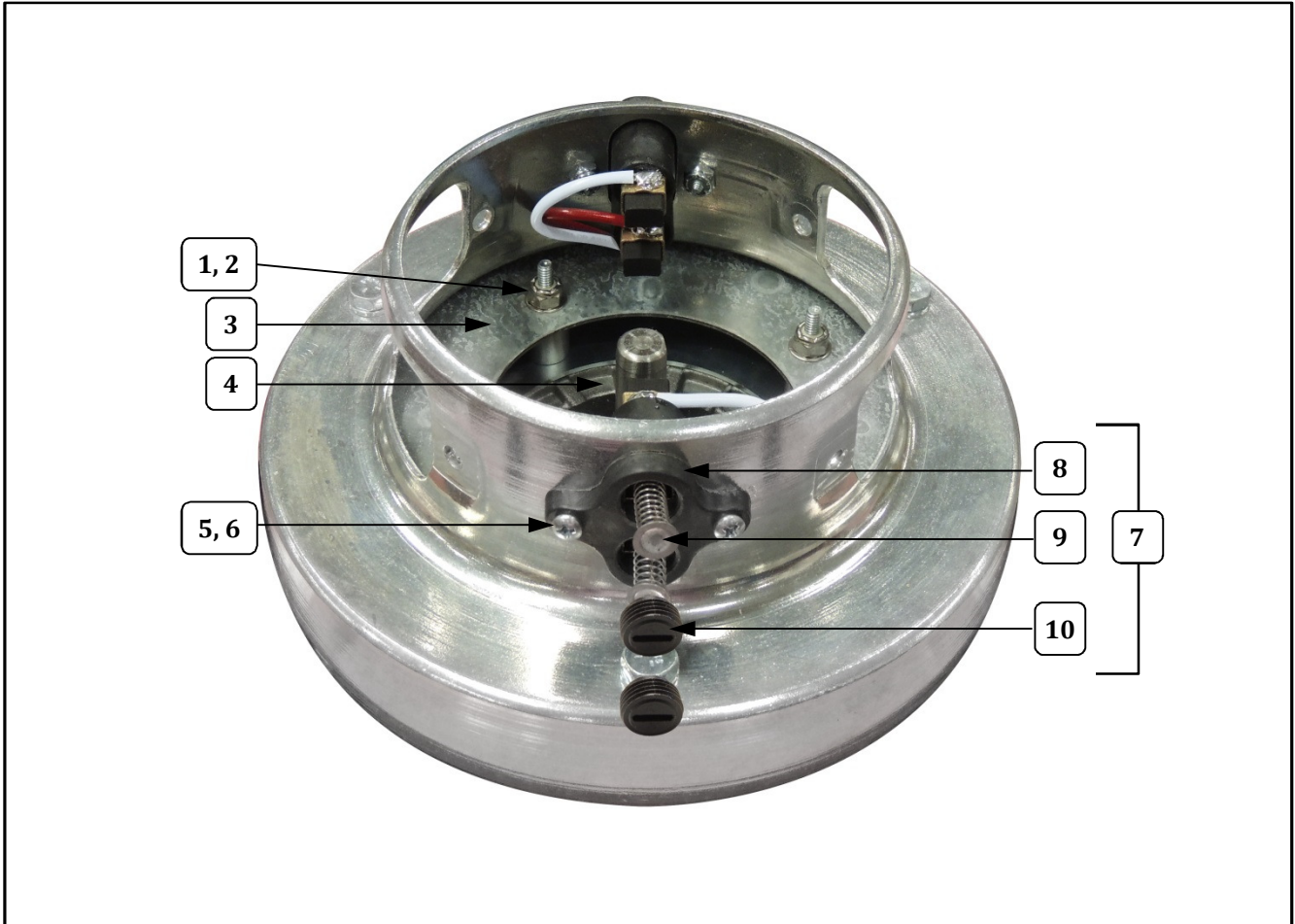

Item	Part Description	Part Number	
		3017-00-000	3024-00-000
1	HEX NUT #10-24 ESLOK	74691	74691
2	.188ID FLATWASHER	77052	77052
3	MOTOR MTG PLATE	42119	42119
4	MOTOR, FLOSS MACHINE	48649	48649
5	6-32 X 1/2 PH PAN HD M/S	47516	47516
6	6-32 GRIP NUT ZINC PLATED	47517	47517
7	BRUSH HOLDER ASSEMBLY (includes Brushes, Caps and Holders)	42382W	42382W
8	DUAL BRUSH HOLDER W/LEADS	42436W	42436W
9	CARBON BRUSH	55007	55007
10	CAP, BRUSH HOLDER	42138	42138



## Bell Housing Interior – Brush Assembly

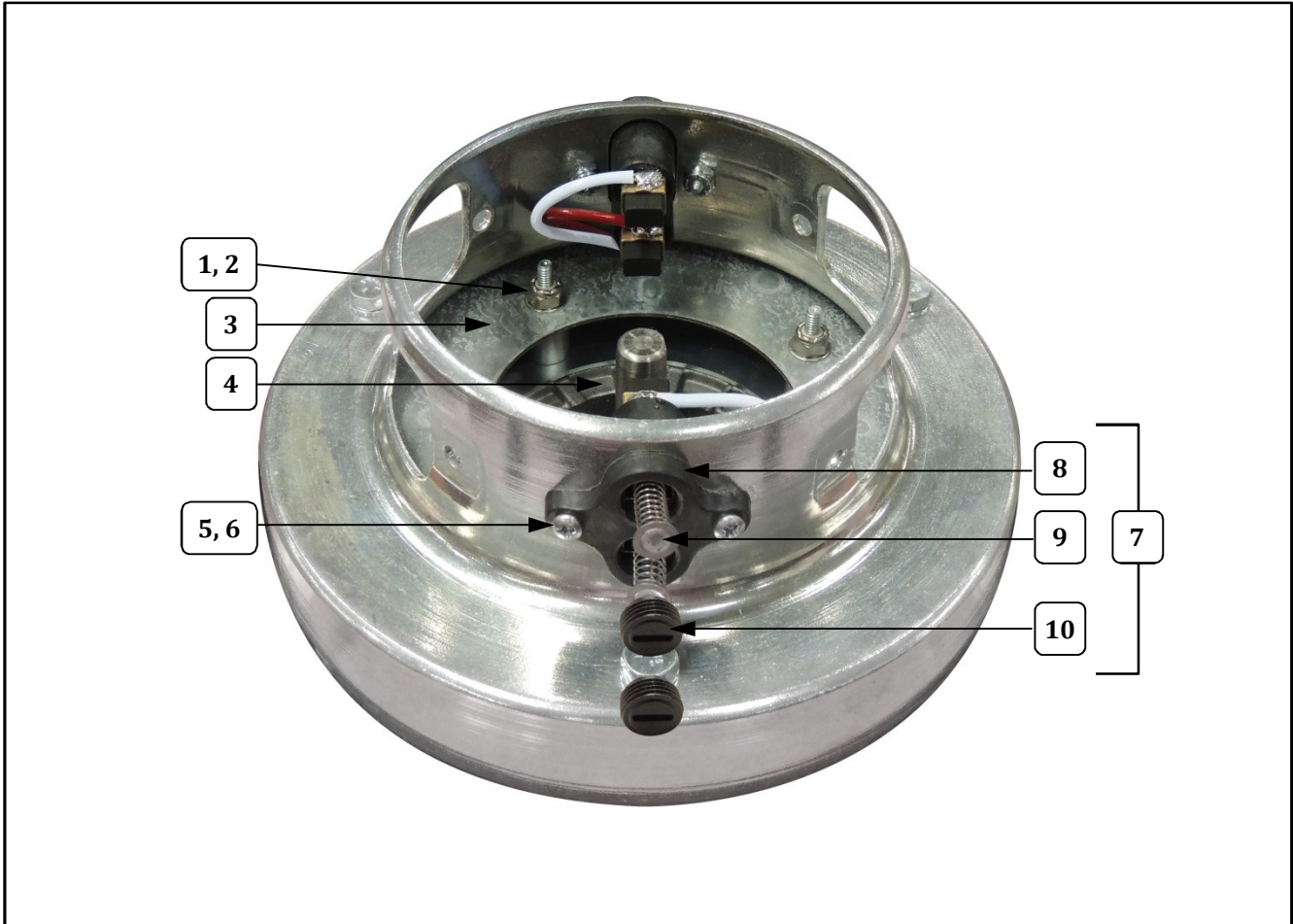

Item	Part Description	Part Number	
		3017-00-000	3024-00-000
1	HEX NUT #10-24 ESLOK	74691	74691
2	.188ID FLATWASHER	77052	77052
3	MOTOR MTG PLATE	42119	42119
4	MOTOR, FLOSS MACHINE	48649	48649
5	6-32 X 1/2 PH PAN HD M/S	47516	47516
6	6-32 GRIP NUT ZINC PLATED	47517	47517
7	BRUSH HOLDER ASSEMBLY (includes Brushes, Caps and Holders)	42382W	42382W
8	DUAL BRUSH HOLDER W/LEADS	42436W	42436W
9	CARBON BRUSH	55007	55007
10	CAP, BRUSH HOLDER	42138	42138



## Bell Housing Interior – Brush Assembly

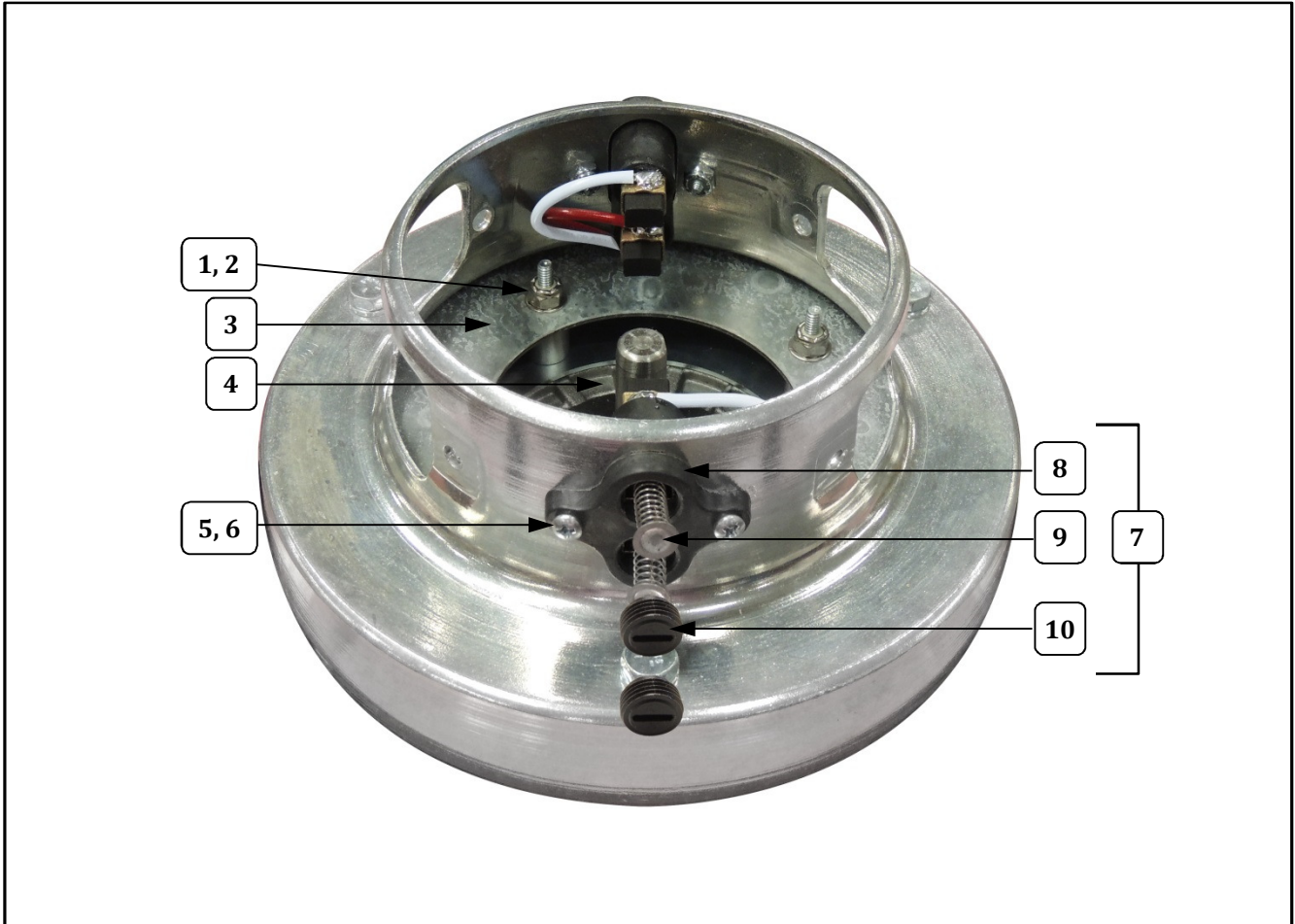

Item	Part Description	Part Number	
		3017-00-000	3024-00-000
1	HEX NUT #10-24 ESLOK	74691	74691
2	.188ID FLATWASHER	77052	77052
3	MOTOR MTG PLATE	42119	42119
4	MOTOR, FLOSS MACHINE	48649	48649
5	6-32 X 1/2 PH PAN HD M/S	47516	47516
6	6-32 GRIP NUT ZINC PLATED	47517	47517
7	BRUSH HOLDER ASSEMBLY (includes Brushes, Caps and Holders)	42382W	42382W
8	DUAL BRUSH HOLDER W/LEADS	42436W	42436W
9	CARBON BRUSH	55007	55007
10	CAP, BRUSH HOLDER	42138	42138



## Bell Housing Interior – Brush Assembly

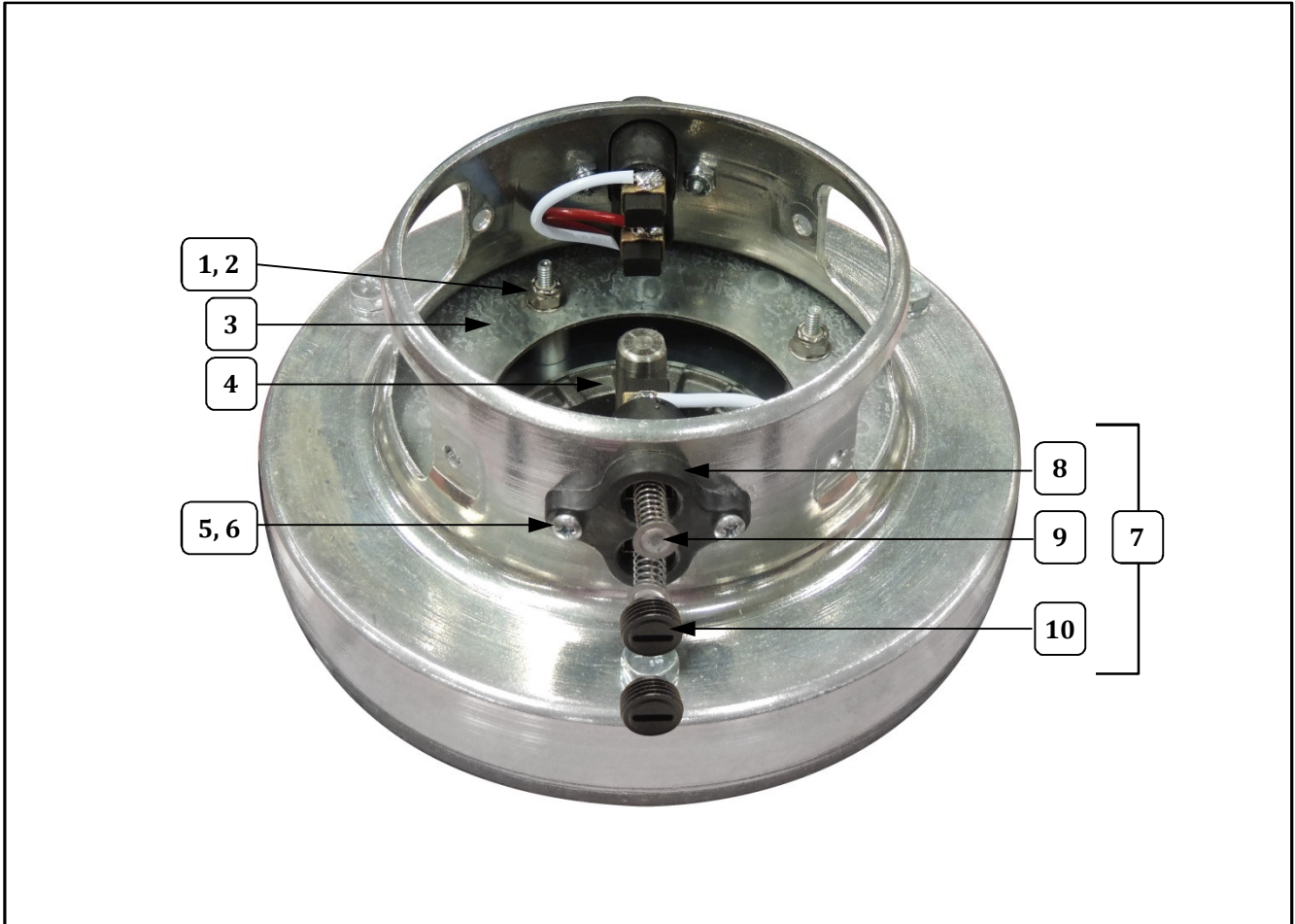

Item	Part Description	Part Number	
		3017-00-000	3024-00-000
1	HEX NUT #10-24 ESLOK	74691	74691
2	.188ID FLATWASHER	77052	77052
3	MOTOR MTG PLATE	42119	42119
4	MOTOR, FLOSS MACHINE	48649	48649
5	6-32 X 1/2 PH PAN HD M/S	47516	47516
6	6-32 GRIP NUT ZINC PLATED	47517	47517
7	BRUSH HOLDER ASSEMBLY (includes Brushes, Caps and Holders)	42382W	42382W
8	DUAL BRUSH HOLDER W/LEADS	42436W	42436W
9	CARBON BRUSH	55007	55007
10	CAP, BRUSH HOLDER	42138	42138



## Bell Housing Interior – Brush Assembly

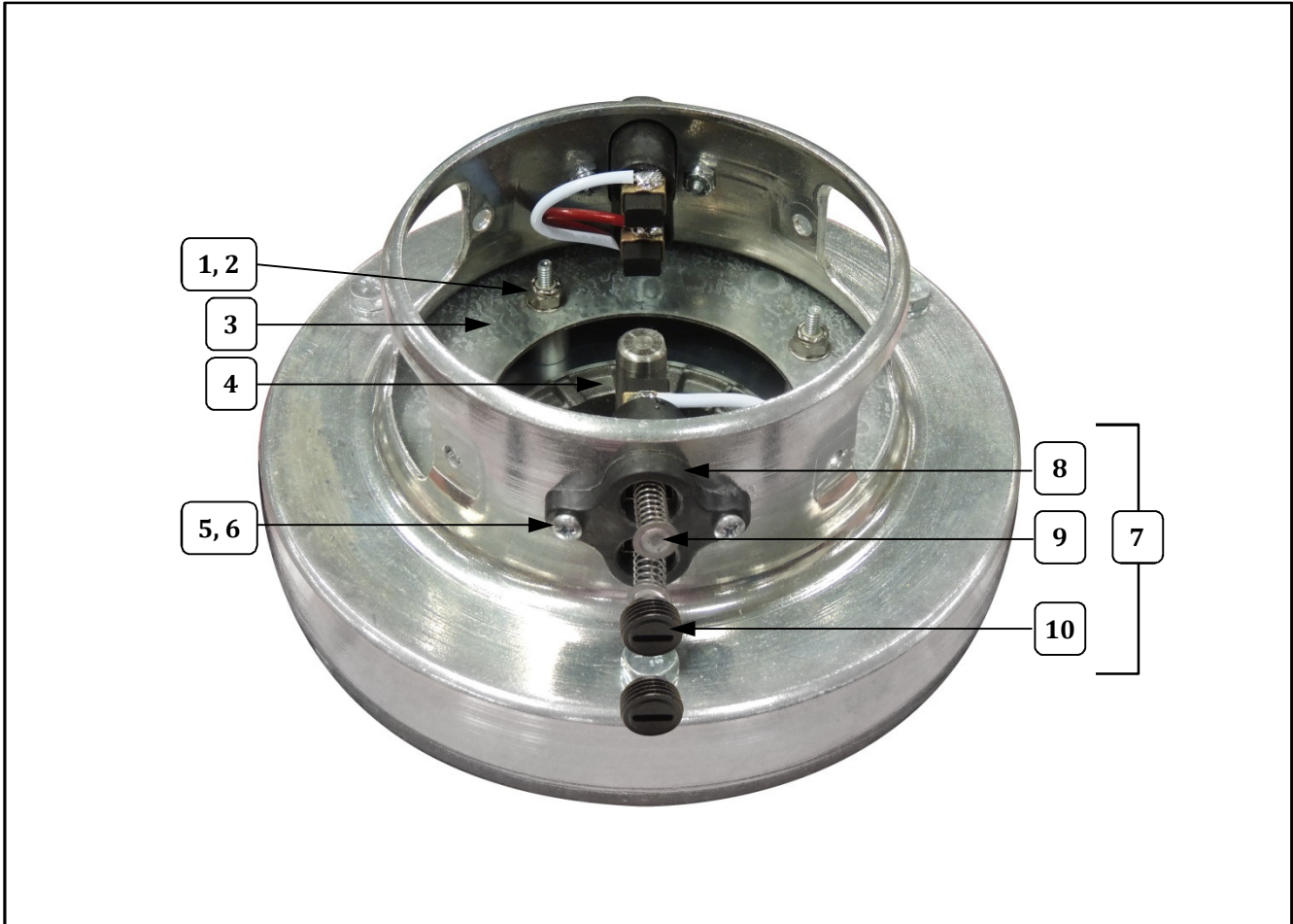

Item	Part Description	Part Number	
		3017-00-000	3024-00-000
1	HEX NUT #10-24 ESLOK	74691	74691
2	.188ID FLATWASHER	77052	77052
3	MOTOR MTG PLATE	42119	42119
4	MOTOR, FLOSS MACHINE	48649	48649
5	6-32 X 1/2 PH PAN HD M/S	47516	47516
6	6-32 GRIP NUT ZINC PLATED	47517	47517
7	BRUSH HOLDER ASSEMBLY (includes Brushes, Caps and Holders)	42382W	42382W
8	DUAL BRUSH HOLDER W/LEADS	42436W	42436W
9	CARBON BRUSH	55007	55007
10	CAP, BRUSH HOLDER	42138	42138



## Bell Housing Interior – Brush Assembly

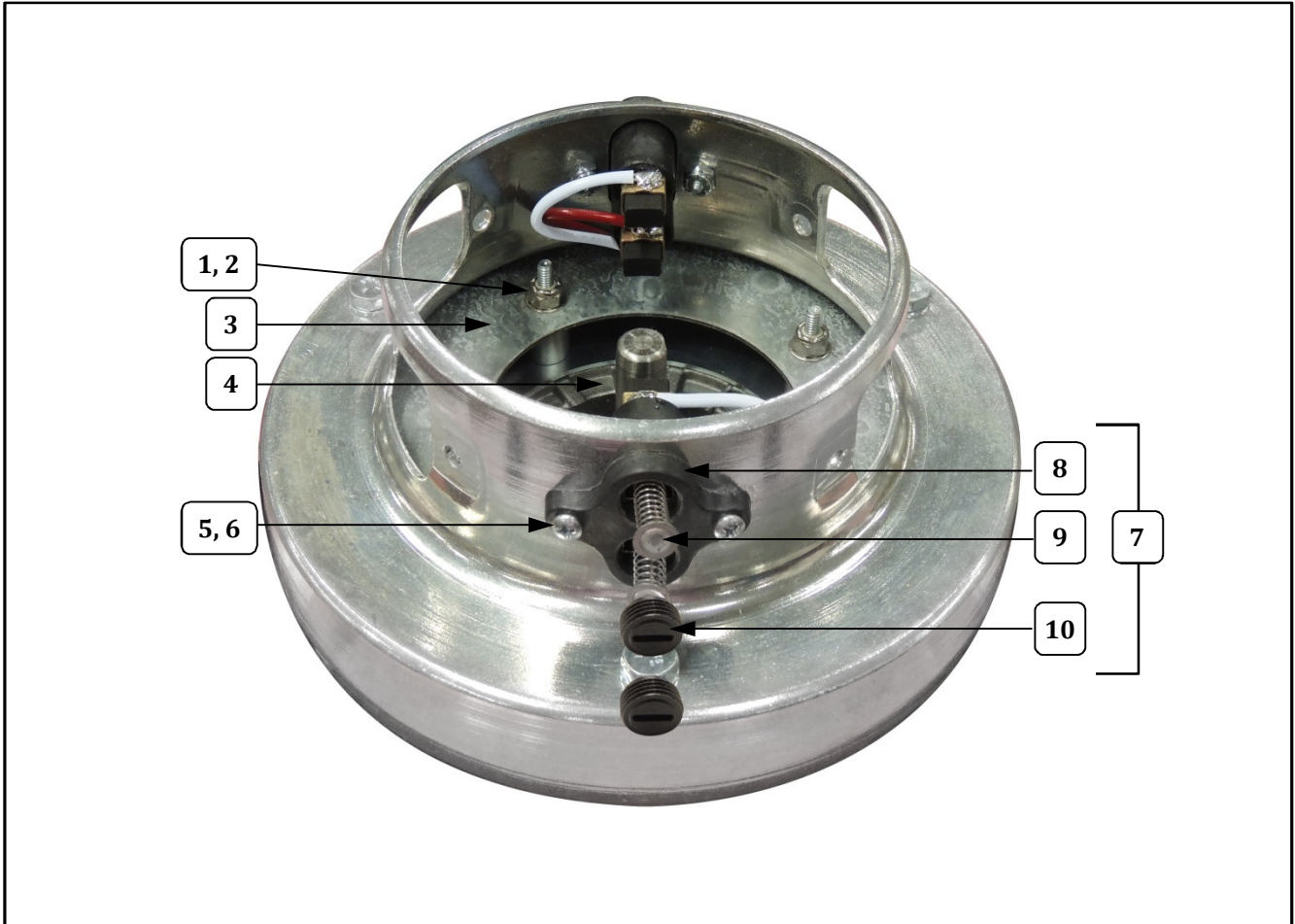

Item	Part Description	Part Number	
		3017-00-000	3024-00-000
1	HEX NUT #10-24 ESLOK	74691	74691
2	.188ID FLATWASHER	77052	77052
3	MOTOR MTG PLATE	42119	42119
4	MOTOR, FLOSS MACHINE	48649	48649
5	6-32 X 1/2 PH PAN HD M/S	47516	47516
6	6-32 GRIP NUT ZINC PLATED	47517	47517
7	BRUSH HOLDER ASSEMBLY (includes Brushes, Caps and Holders)	42382W	42382W
8	DUAL BRUSH HOLDER W/LEADS	42436W	42436W
9	CARBON BRUSH	55007	55007
10	CAP, BRUSH HOLDER	42138	42138



## Bell Housing Interior – Brush Assembly

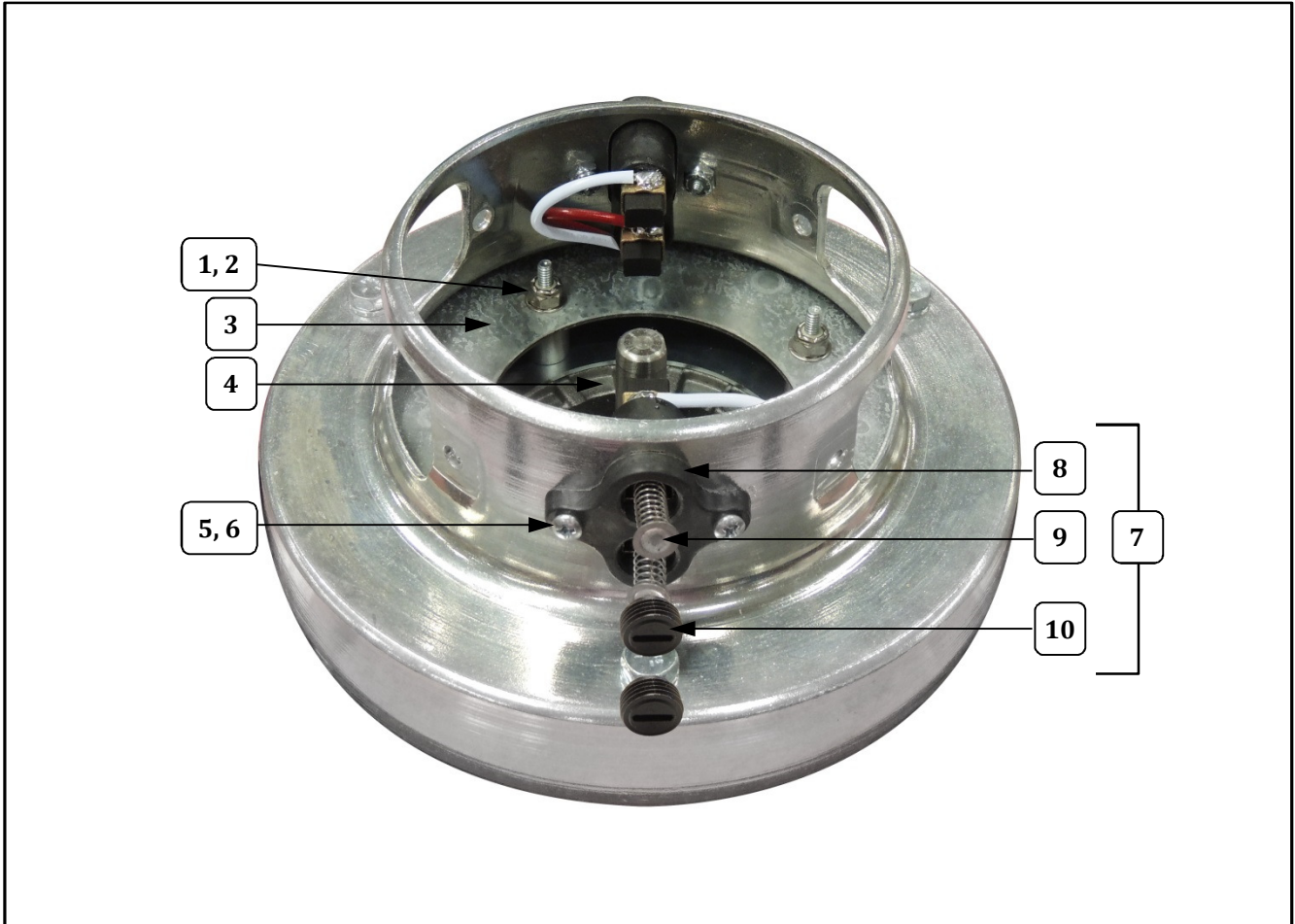

Item	Part Description	Part Number	
		3017-00-000	3024-00-000
1	HEX NUT #10-24 ESLOK	74691	74691
2	.188ID FLATWASHER	77052	77052
3	MOTOR MTG PLATE	42119	42119
4	MOTOR, FLOSS MACHINE	48649	48649
5	6-32 X 1/2 PH PAN HD M/S	47516	47516
6	6-32 GRIP NUT ZINC PLATED	47517	47517
7	BRUSH HOLDER ASSEMBLY (includes Brushes, Caps and Holders)	42382W	42382W
8	DUAL BRUSH HOLDER W/LEADS	42436W	42436W
9	CARBON BRUSH	55007	55007
10	CAP, BRUSH HOLDER	42138	42138



## Bell Housing Interior – Brush Assembly

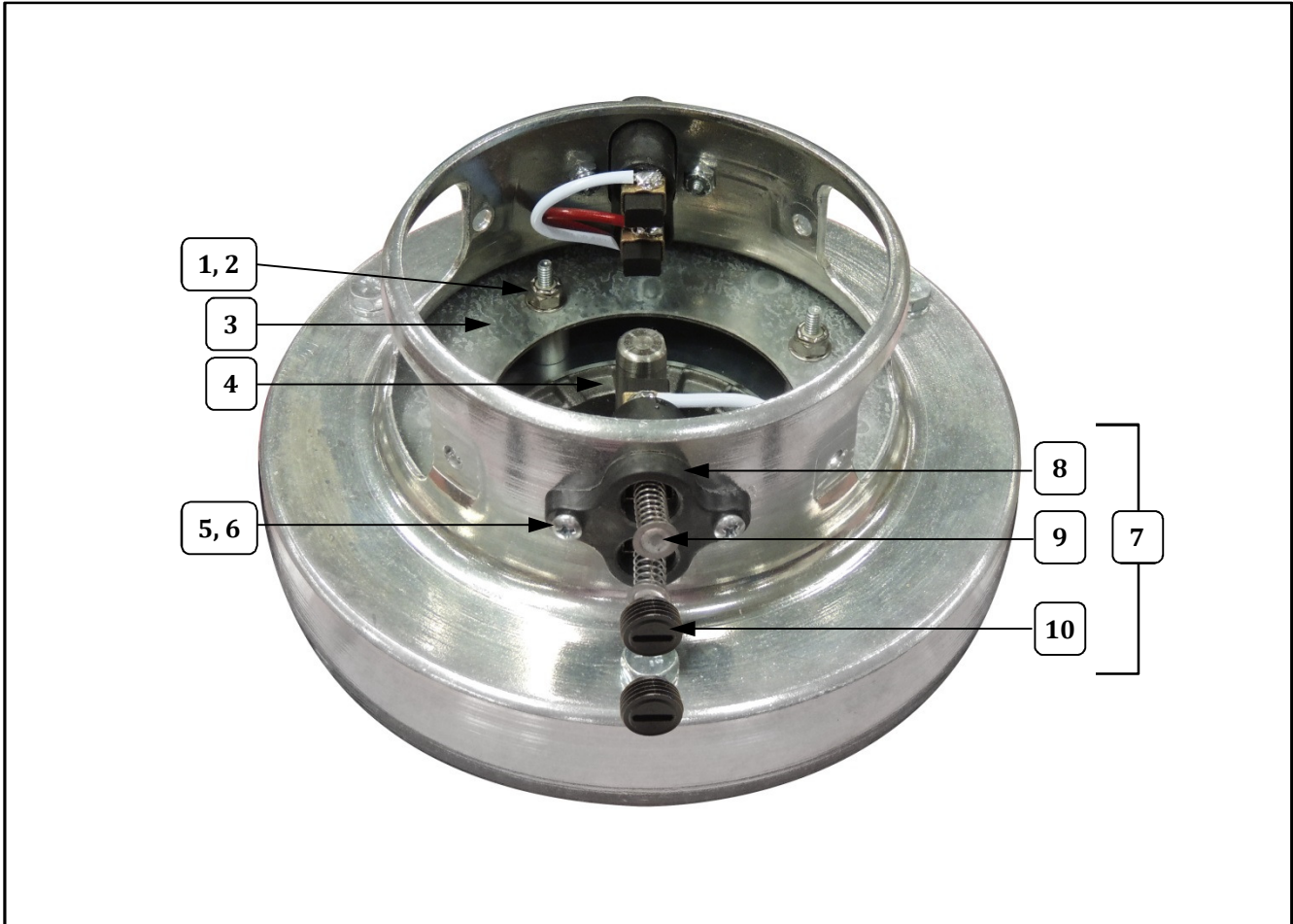

Item	Part Description	Part Number	
		3017-00-000	3024-00-000
1	HEX NUT #10-24 ESLOK	74691	74691
2	.188ID FLATWASHER	77052	77052
3	MOTOR MTG PLATE	42119	42119
4	MOTOR, FLOSS MACHINE	48649	48649
5	6-32 X 1/2 PH PAN HD M/S	47516	47516
6	6-32 GRIP NUT ZINC PLATED	47517	47517
7	BRUSH HOLDER ASSEMBLY (includes Brushes, Caps and Holders)	42382W	42382W
8	DUAL BRUSH HOLDER W/LEADS	42436W	42436W
9	CARBON BRUSH	55007	55007
10	CAP, BRUSH HOLDER	42138	42138



## Bell Housing Interior – Brush Assembly

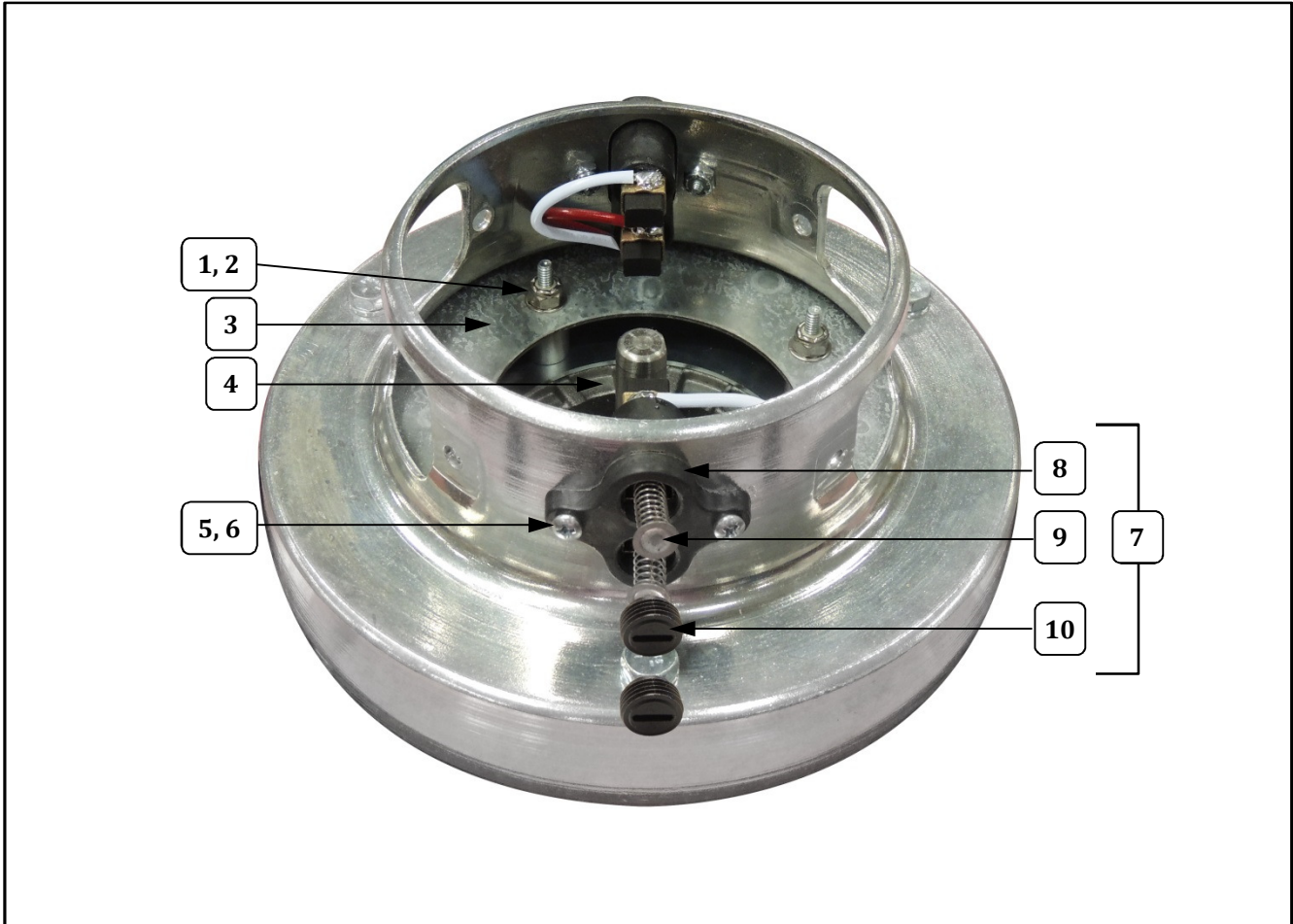

Item	Part Description	Part Number	
		3017-00-000	3024-00-000
1	HEX NUT #10-24 ESLOK	74691	74691
2	.188ID FLATWASHER	77052	77052
3	MOTOR MTG PLATE	42119	42119
4	MOTOR, FLOSS MACHINE	48649	48649
5	6-32 X 1/2 PH PAN HD M/S	47516	47516
6	6-32 GRIP NUT ZINC PLATED	47517	47517
7	BRUSH HOLDER ASSEMBLY (includes Brushes, Caps and Holders)	42382W	42382W
8	DUAL BRUSH HOLDER W/LEADS	42436W	42436W
9	CARBON BRUSH	55007	55007
10	CAP, BRUSH HOLDER	42138	42138



## Bell Housing Interior – Brush Assembly

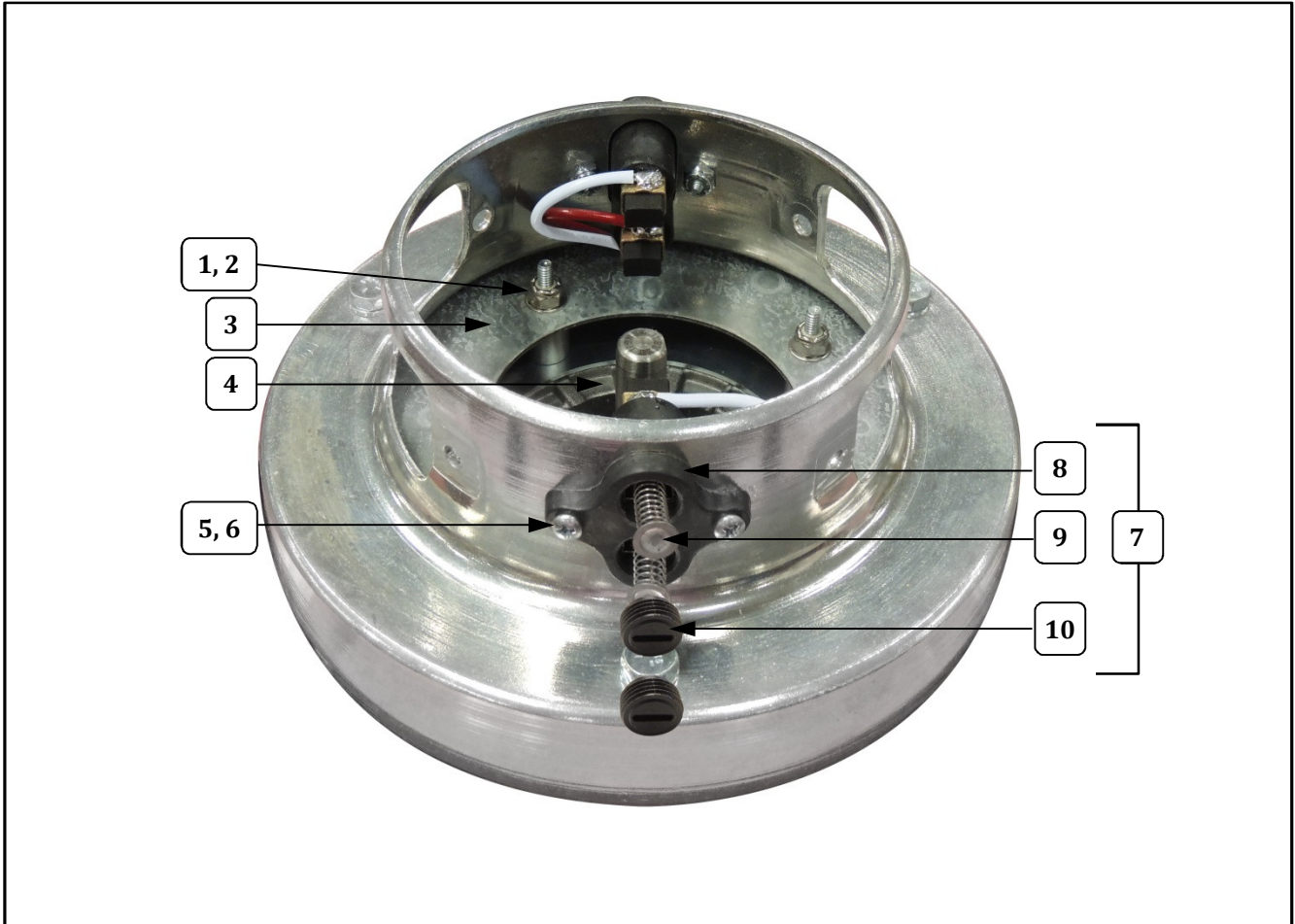

Item	Part Description	Part Number	
		3017-00-000	3024-00-000
1	HEX NUT #10-24 ESLOK	74691	74691
2	.188ID FLATWASHER	77052	77052
3	MOTOR MTG PLATE	42119	42119
4	MOTOR, FLOSS MACHINE	48649	48649
5	6-32 X 1/2 PH PAN HD M/S	47516	47516
6	6-32 GRIP NUT ZINC PLATED	47517	47517
7	BRUSH HOLDER ASSEMBLY (includes Brushes, Caps and Holders)	42382W	42382W
8	DUAL BRUSH HOLDER W/LEADS	42436W	42436W
9	CARBON BRUSH	55007	55007
10	CAP, BRUSH HOLDER	42138	42138



## Bell Housing Interior – Brush Assembly

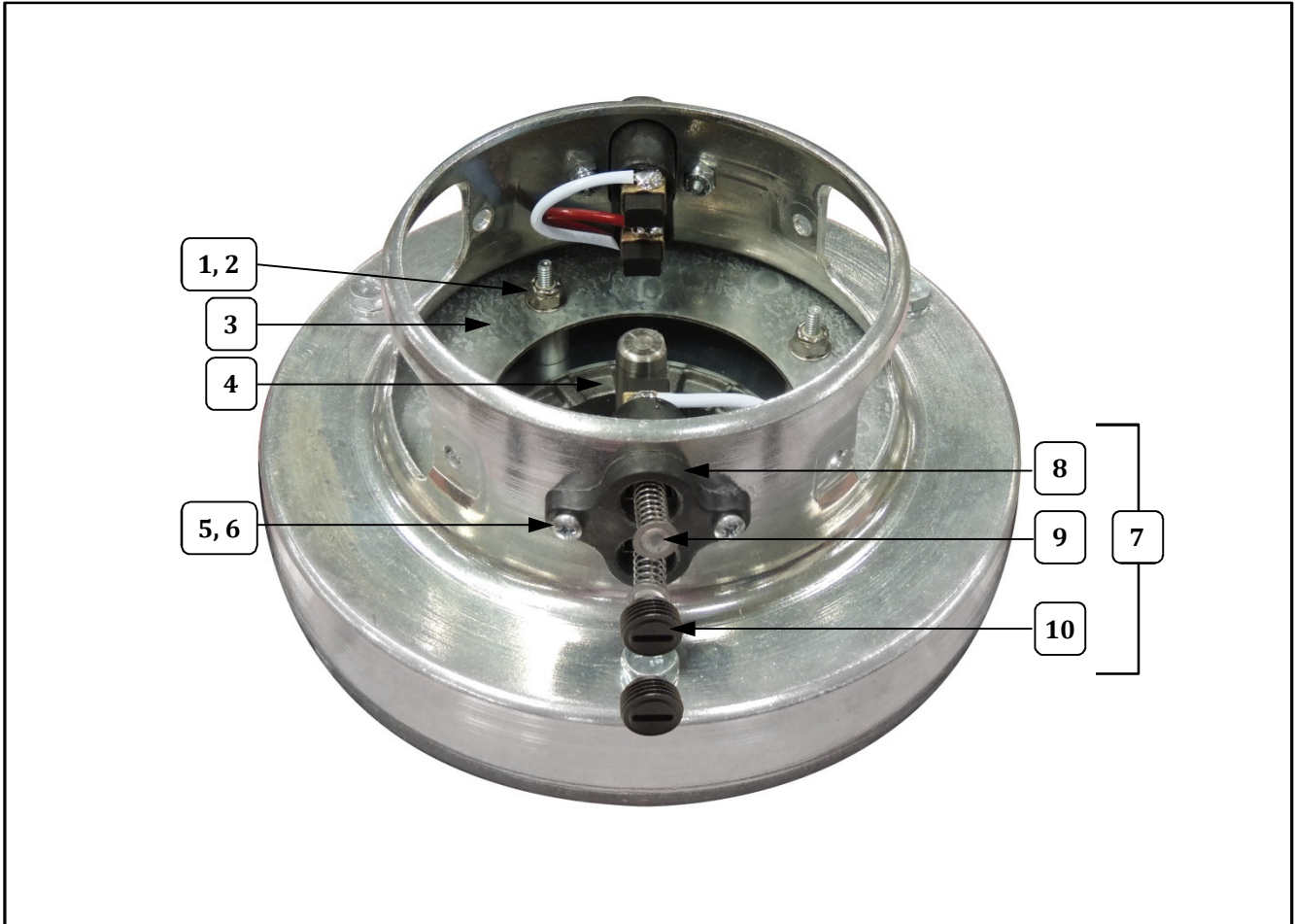

Item	Part Description	Part Number	
		3017-00-000	3024-00-000
1	HEX NUT #10-24 ESLOK	74691	74691
2	.188ID FLATWASHER	77052	77052
3	MOTOR MTG PLATE	42119	42119
4	MOTOR, FLOSS MACHINE	48649	48649
5	6-32 X 1/2 PH PAN HD M/S	47516	47516
6	6-32 GRIP NUT ZINC PLATED	47517	47517
7	BRUSH HOLDER ASSEMBLY (includes Brushes, Caps and Holders)	42382W	42382W
8	DUAL BRUSH HOLDER W/LEADS	42436W	42436W
9	CARBON BRUSH	55007	55007
10	CAP, BRUSH HOLDER	42138	42138



## Bell Housing Interior – Brush Assembly

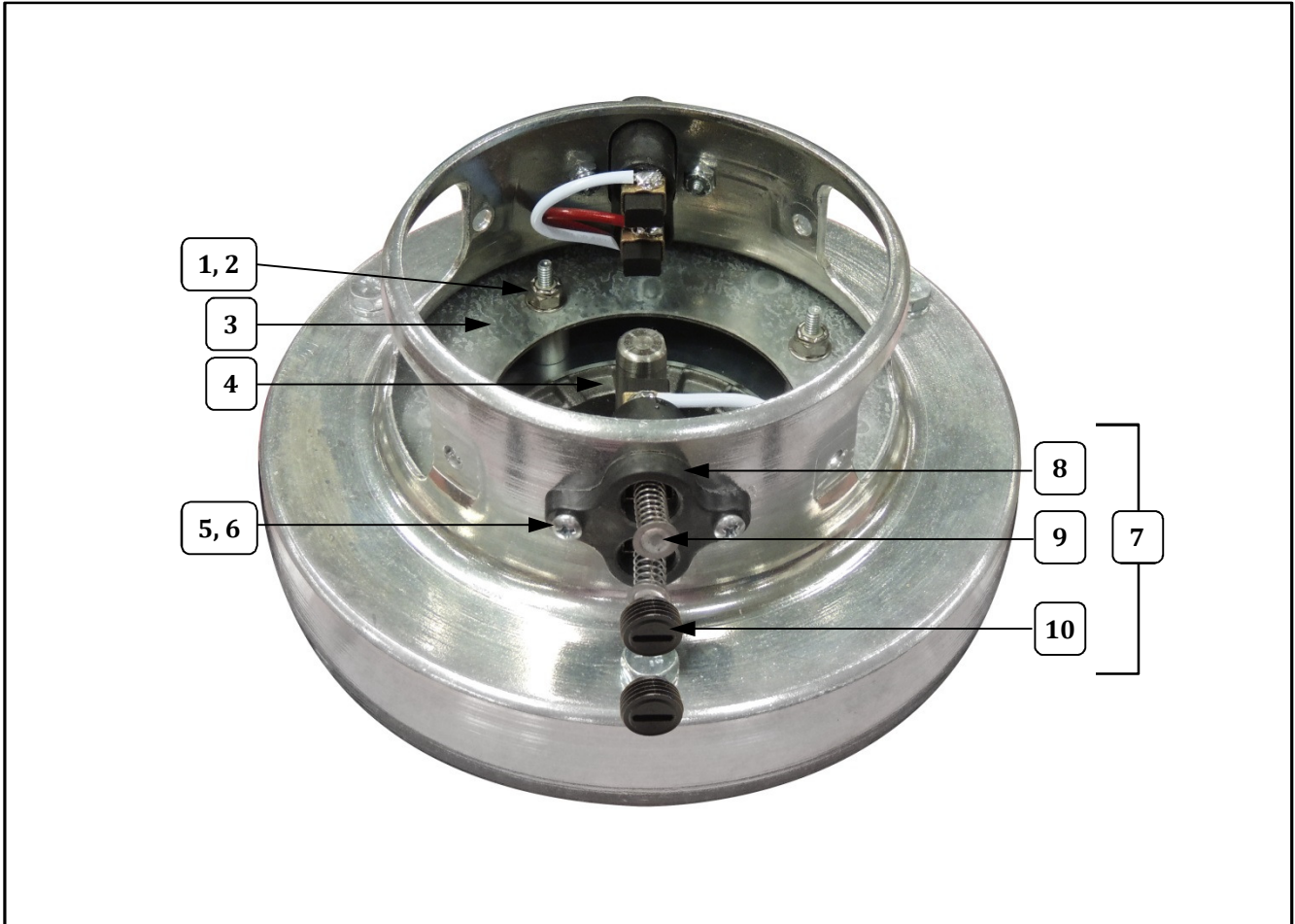

Item	Part Description	Part Number	
		3017-00-000	3024-00-000
1	HEX NUT #10-24 ESLOK	74691	74691
2	.188ID FLATWASHER	77052	77052
3	MOTOR MTG PLATE	42119	42119
4	MOTOR, FLOSS MACHINE	48649	48649
5	6-32 X 1/2 PH PAN HD M/S	47516	47516
6	6-32 GRIP NUT ZINC PLATED	47517	47517
7	BRUSH HOLDER ASSEMBLY (includes Brushes, Caps and Holders)	42382W	42382W
8	DUAL BRUSH HOLDER W/LEADS	42436W	42436W
9	CARBON BRUSH	55007	55007
10	CAP, BRUSH HOLDER	42138	42138



## Bell Housing Interior – Brush Assembly

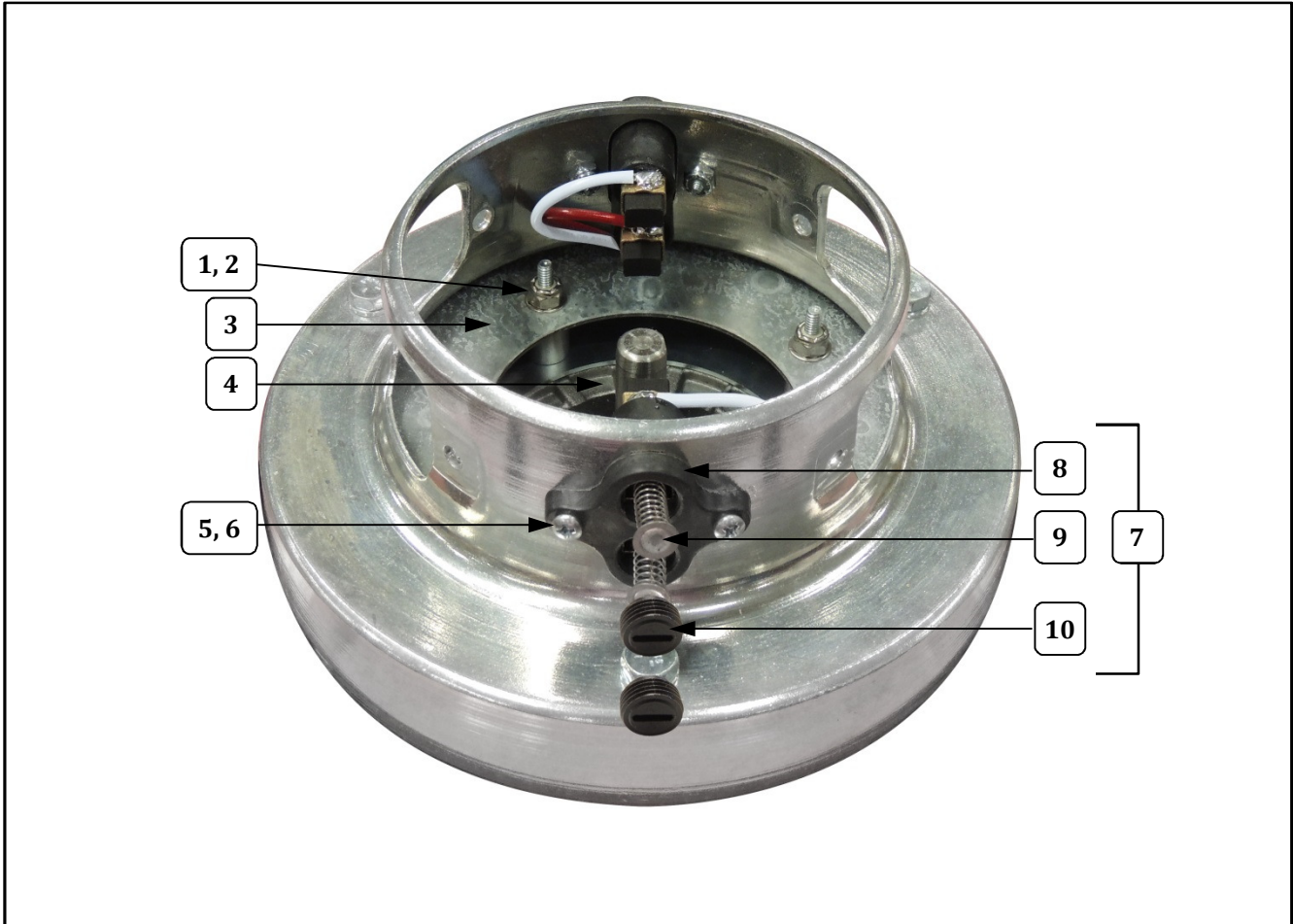

Item	Part Description	Part Number	
		3017-00-000	3024-00-000
1	HEX NUT #10-24 ESLOK	74691	74691
2	.188ID FLATWASHER	77052	77052
3	MOTOR MTG PLATE	42119	42119
4	MOTOR, FLOSS MACHINE	48649	48649
5	6-32 X 1/2 PH PAN HD M/S	47516	47516
6	6-32 GRIP NUT ZINC PLATED	47517	47517
7	BRUSH HOLDER ASSEMBLY (includes Brushes, Caps and Holders)	42382W	42382W
8	DUAL BRUSH HOLDER W/LEADS	42436W	42436W
9	CARBON BRUSH	55007	55007
10	CAP, BRUSH HOLDER	42138	42138



## Bell Housing Interior – Brush Assembly

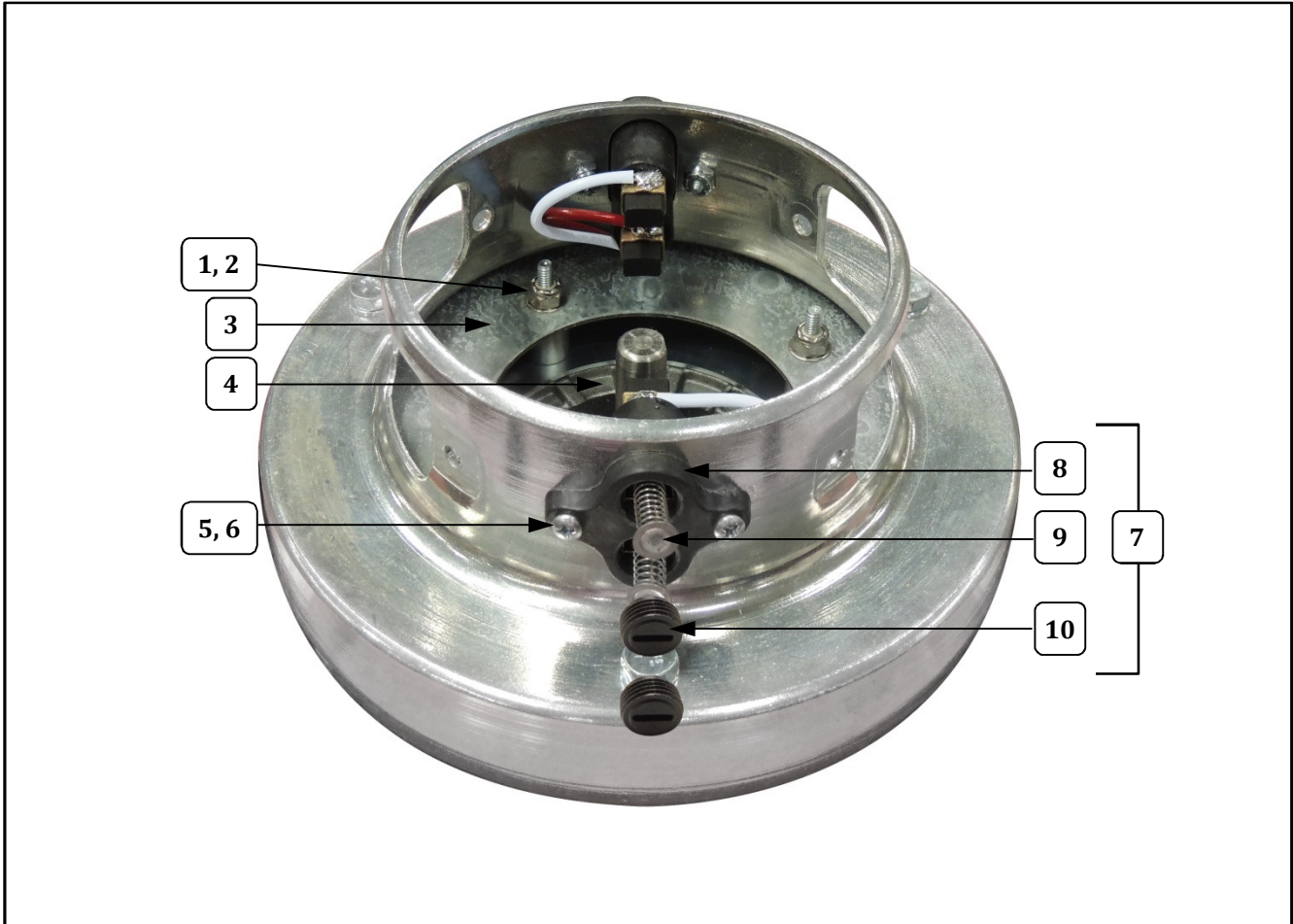

Item	Part Description	Part Number	
		3017-00-000	3024-00-000
1	HEX NUT #10-24 ESLOK	74691	74691
2	.188ID FLATWASHER	77052	77052
3	MOTOR MTG PLATE	42119	42119
4	MOTOR, FLOSS MACHINE	48649	48649
5	6-32 X 1/2 PH PAN HD M/S	47516	47516
6	6-32 GRIP NUT ZINC PLATED	47517	47517
7	BRUSH HOLDER ASSEMBLY (includes Brushes, Caps and Holders)	42382W	42382W
8	DUAL BRUSH HOLDER W/LEADS	42436W	42436W
9	CARBON BRUSH	55007	55007
10	CAP, BRUSH HOLDER	42138	42138

## Cabinet Interior - Parts List

Item	Part Description	Part Number	
		3017-00-000	3024-00-000
1	MOTOR, FLOSS MACHINE	48649	48649
2	SWITCH, LIGHTED ROCKER GR	42798	42798
3	ELECTRONIC HEAT CONTROL	42558	42558
4	6-32 X 3/8 PHIL PAN M/S	39000	39000
5	WASHER #6 INTERNAL TOOTH	76188	76188
6	RELAY, 120VAC, DPST-NO	48590	48590
7	6-32 GRIP NUT ZINC PLATED	47517	47517
8	TERMINAL BLOCK, 2 POS	55620	55620
9	8-32 X 3/4 PHIL PAN MS SS	39007	39007
10	HEX NUT #8-32 STAINLESS	89129	89129
11	ACORN NUT 1/4-20	49068	49068
12	SPRING, SUSPENSION MEDIUM	42524	42524
13	SCREW 1/4-20X3/8 PN HD PH	42360	42360
14	10-24 TINNERMAM FASTENER	42221	42221

## Floss Pan and Whirlgrip Stabilizer

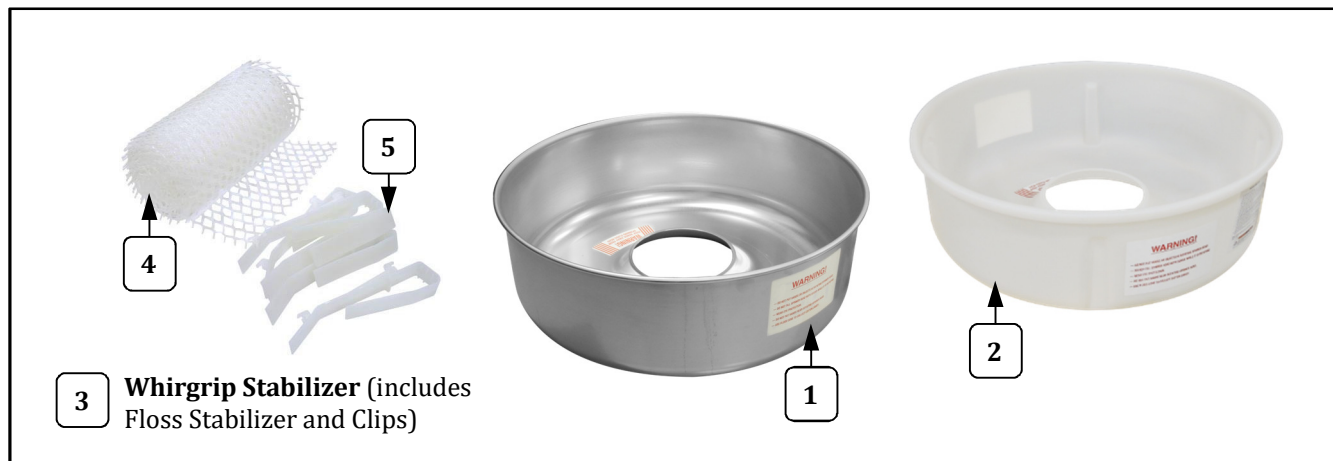

Item	Part Description	Part Number	
		3017-00-000	3024-00-000
1	FLOSS PAN (aluminum)	42040	
2	FLOSS PAN (non-metal)		42040NMR
3	WHIRLGRIP STABILIZER (Includes Floss Stabilizer and Clips)	3010	3010NM
4	FLOSS STABILIZER (Web)	43032	43032NM
5	WHIRLGRIP CLIPS	77470	77470

## Cabinet Interior - Parts List

Item	Part Description	Part Number	
		3017-00-000	3024-00-000
1	MOTOR, FLOSS MACHINE	48649	48649
2	SWITCH, LIGHTED ROCKER GR	42798	42798
3	ELECTRONIC HEAT CONTROL	42558	42558
4	6-32 X 3/8 PHIL PAN M/S	39000	39000
5	WASHER #6 INTERNAL TOOTH	76188	76188
6	RELAY, 120VAC, DPST-NO	48590	48590
7	6-32 GRIP NUT ZINC PLATED	47517	47517
8	TERMINAL BLOCK, 2 POS	55620	55620
9	8-32 X 3/4 PHIL PAN MS SS	39007	39007
10	HEX NUT #8-32 STAINLESS	89129	89129
11	ACORN NUT 1/4-20	49068	49068
12	SPRING, SUSPENSION MEDIUM	42524	42524
13	SCREW 1/4-20X3/8 PN HD PH	42360	42360
14	10-24 TINNERMAM FASTENER	42221	42221

## Floss Pan and Whirlgrip Stabilizer

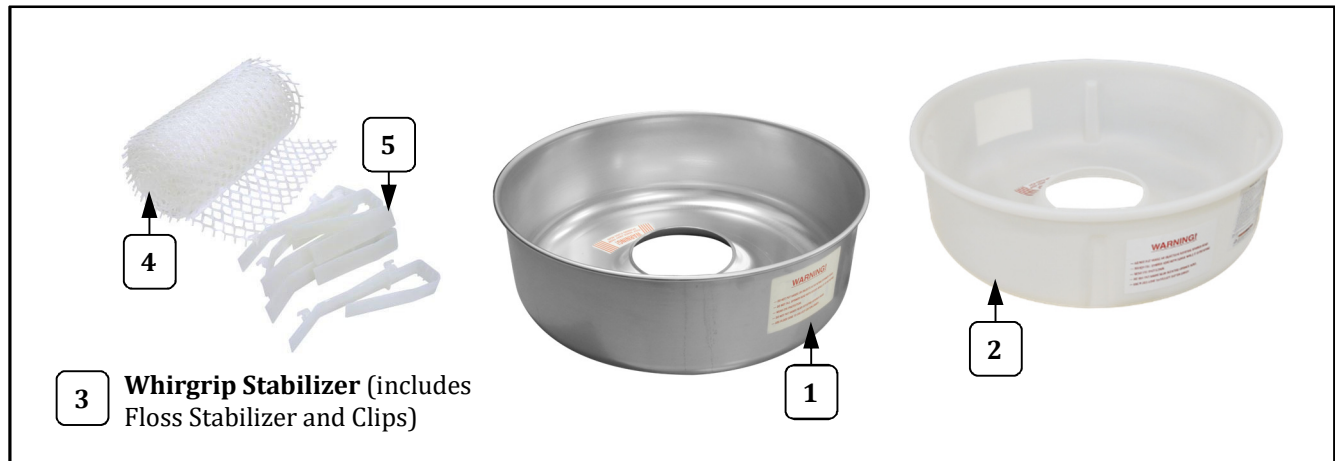

Item	Part Description	Part Number	
		3017-00-000	3024-00-000
1	FLOSS PAN (aluminum)	42040	
2	FLOSS PAN (non-metal)		42040NMR
3	WHIRLGRIP STABILIZER (Includes Floss Stabilizer and Clips)	3010	3010NM
4	FLOSS STABILIZER (Web)	43032	43032NM
5	WHIRLGRIP CLIPS	77470	77470

## Cabinet Interior - Parts List

Item	Part Description	Part Number	
		3017-00-000	3024-00-000
1	MOTOR, FLOSS MACHINE	48649	48649
2	SWITCH, LIGHTED ROCKER GR	42798	42798
3	ELECTRONIC HEAT CONTROL	42558	42558
4	6-32 X 3/8 PHIL PAN M/S	39000	39000
5	WASHER #6 INTERNAL TOOTH	76188	76188
6	RELAY, 120VAC, DPST-NO	48590	48590
7	6-32 GRIP NUT ZINC PLATED	47517	47517
8	TERMINAL BLOCK, 2 POS	55620	55620
9	8-32 X 3/4 PHIL PAN MS SS	39007	39007
10	HEX NUT #8-32 STAINLESS	89129	89129
11	ACORN NUT 1/4-20	49068	49068
12	SPRING, SUSPENSION MEDIUM	42524	42524
13	SCREW 1/4-20X3/8 PN HD PH	42360	42360
14	10-24 TINNERMAM FASTENER	42221	42221

## Floss Pan and Whirlgrip Stabilizer

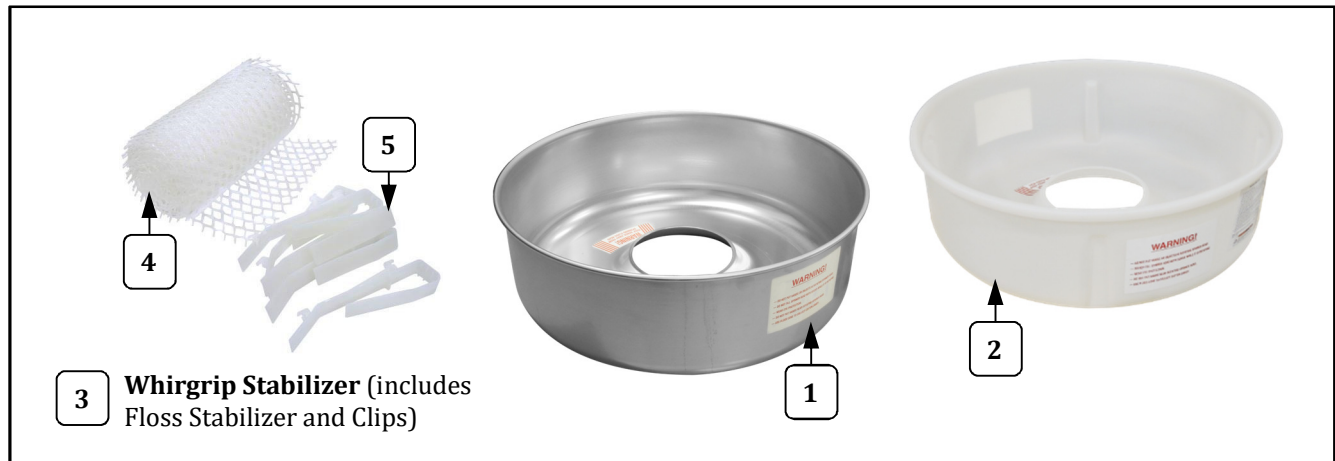

Item	Part Description	Part Number	
		3017-00-000	3024-00-000
1	FLOSS PAN (aluminum)	42040	
2	FLOSS PAN (non-metal)		42040NMR
3	WHIRLGRIP STABILIZER (Includes Floss Stabilizer and Clips)	3010	3010NM
4	FLOSS STABILIZER (Web)	43032	43032NM
5	WHIRLGRIP CLIPS	77470	77470

## Cabinet Interior - Parts List

Item	Part Description	Part Number	
		3017-00-000	3024-00-000
1	MOTOR, FLOSS MACHINE	48649	48649
2	SWITCH, LIGHTED ROCKER GR	42798	42798
3	ELECTRONIC HEAT CONTROL	42558	42558
4	6-32 X 3/8 PHIL PAN M/S	39000	39000
5	WASHER #6 INTERNAL TOOTH	76188	76188
6	RELAY, 120VAC, DPST-NO	48590	48590
7	6-32 GRIP NUT ZINC PLATED	47517	47517
8	TERMINAL BLOCK, 2 POS	55620	55620
9	8-32 X 3/4 PHIL PAN MS SS	39007	39007
10	HEX NUT #8-32 STAINLESS	89129	89129
11	ACORN NUT 1/4-20	49068	49068
12	SPRING, SUSPENSION MEDIUM	42524	42524
13	SCREW 1/4-20X3/8 PN HD PH	42360	42360
14	10-24 TINNERMAM FASTENER	42221	42221

## Floss Pan and Whirlgrip Stabilizer

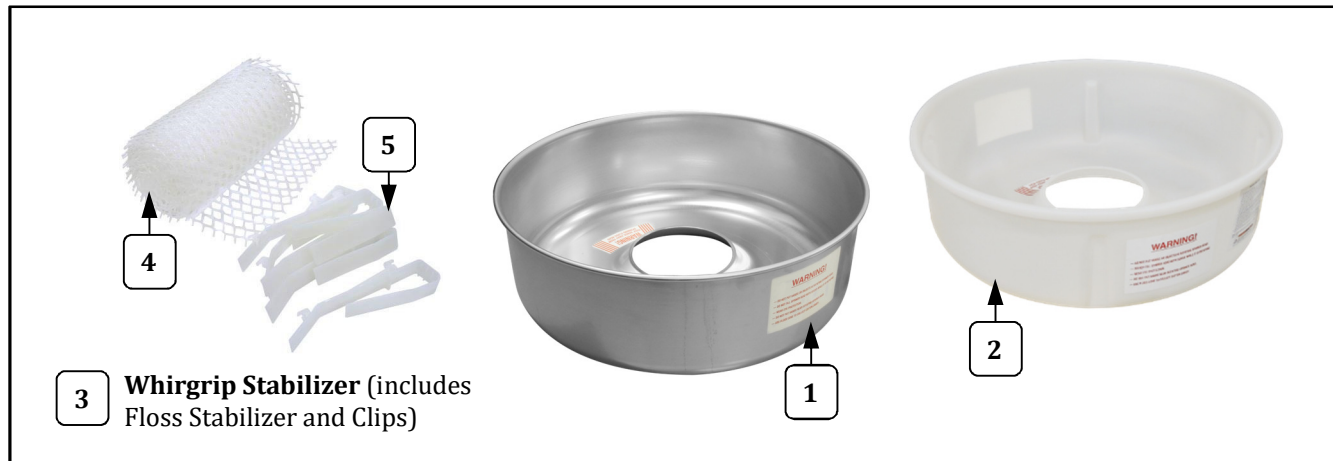

Item	Part Description	Part Number	
		3017-00-000	3024-00-000
1	FLOSS PAN (aluminum)	42040	
2	FLOSS PAN (non-metal)		42040NMR
3	WHIRLGRIP STABILIZER (Includes Floss Stabilizer and Clips)	3010	3010NM
4	FLOSS STABILIZER (Web)	43032	43032NM
5	WHIRLGRIP CLIPS	77470	77470

## Cabinet Interior - Parts List

Item	Part Description	Part Number	
		3017-00-000	3024-00-000
1	MOTOR, FLOSS MACHINE	48649	48649
2	SWITCH, LIGHTED ROCKER GR	42798	42798
3	ELECTRONIC HEAT CONTROL	42558	42558
4	6-32 X 3/8 PHIL PAN M/S	39000	39000
5	WASHER #6 INTERNAL TOOTH	76188	76188
6	RELAY, 120VAC, DPST-NO	48590	48590
7	6-32 GRIP NUT ZINC PLATED	47517	47517
8	TERMINAL BLOCK, 2 POS	55620	55620
9	8-32 X 3/4 PHIL PAN MS SS	39007	39007
10	HEX NUT #8-32 STAINLESS	89129	89129
11	ACORN NUT 1/4-20	49068	49068
12	SPRING, SUSPENSION MEDIUM	42524	42524
13	SCREW 1/4-20X3/8 PN HD PH	42360	42360
14	10-24 TINNERMAM FASTENER	42221	42221

## Floss Pan and Whirlgrip Stabilizer

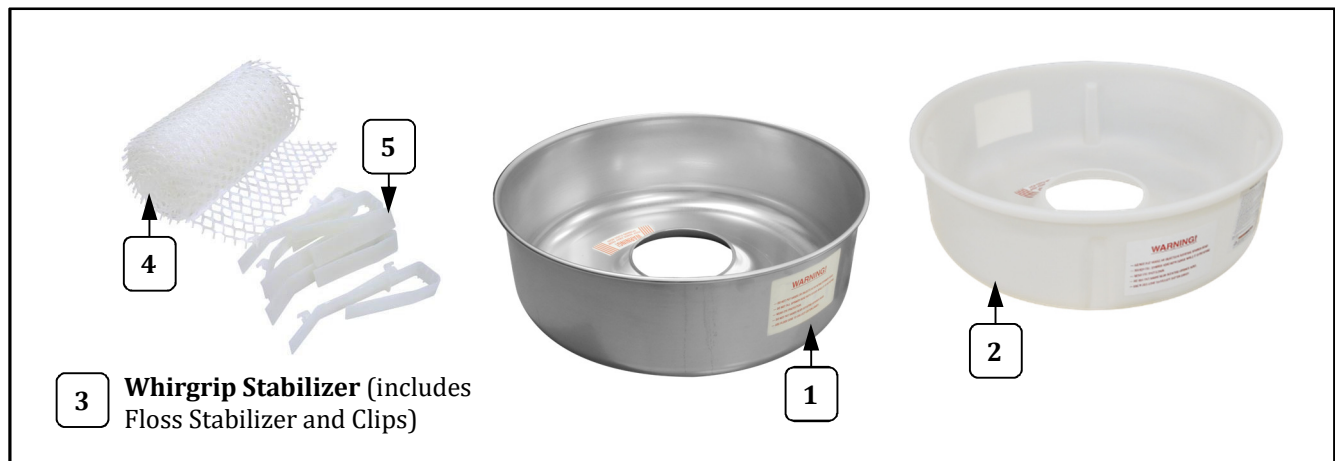

Item	Part Description	Part Number	
		3017-00-000	3024-00-000
1	FLOSS PAN (aluminum)	42040	
2	FLOSS PAN (non-metal)		42040NMR
3	WHIRLGRIP STABILIZER (Includes Floss Stabilizer and Clips)	3010	3010NM
4	FLOSS STABILIZER (Web)	43032	43032NM
5	WHIRLGRIP CLIPS	77470	77470

## Cabinet Interior - Parts List

Item	Part Description	Part Number	
		3017-00-000	3024-00-000
1	MOTOR, FLOSS MACHINE	48649	48649
2	SWITCH, LIGHTED ROCKER GR	42798	42798
3	ELECTRONIC HEAT CONTROL	42558	42558
4	6-32 X 3/8 PHIL PAN M/S	39000	39000
5	WASHER #6 INTERNAL TOOTH	76188	76188
6	RELAY, 120VAC, DPST-NO	48590	48590
7	6-32 GRIP NUT ZINC PLATED	47517	47517
8	TERMINAL BLOCK, 2 POS	55620	55620
9	8-32 X 3/4 PHIL PAN MS SS	39007	39007
10	HEX NUT #8-32 STAINLESS	89129	89129
11	ACORN NUT 1/4-20	49068	49068
12	SPRING, SUSPENSION MEDIUM	42524	42524
13	SCREW 1/4-20X3/8 PN HD PH	42360	42360
14	10-24 TINNERMAM FASTENER	42221	42221

## Floss Pan and Whirlgrip Stabilizer

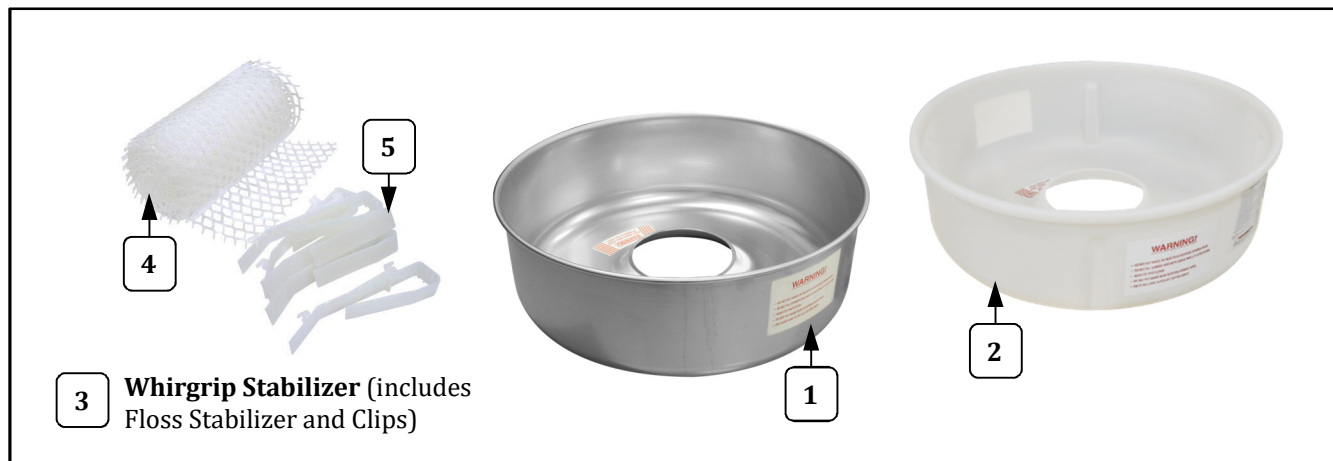

Item	Part Description	Part Number	
		3017-00-000	3024-00-000
1	FLOSS PAN (aluminum)	42040	
2	FLOSS PAN (non-metal)		42040NMR
3	WHIRLGRIP STABILIZER (Includes Floss Stabilizer and Clips)	3010	3010NM
4	FLOSS STABILIZER (Web)	43032	43032NM
5	WHIRLGRIP CLIPS	77470	77470

## Cabinet Interior - Parts List

Item	Part Description	Part Number	
		3017-00-000	3024-00-000
1	MOTOR, FLOSS MACHINE	48649	48649
2	SWITCH, LIGHTED ROCKER GR	42798	42798
3	ELECTRONIC HEAT CONTROL	42558	42558
4	6-32 X 3/8 PHIL PAN M/S	39000	39000
5	WASHER #6 INTERNAL TOOTH	76188	76188
6	RELAY, 120VAC, DPST-NO	48590	48590
7	6-32 GRIP NUT ZINC PLATED	47517	47517
8	TERMINAL BLOCK, 2 POS	55620	55620
9	8-32 X 3/4 PHIL PAN MS SS	39007	39007
10	HEX NUT #8-32 STAINLESS	89129	89129
11	ACORN NUT 1/4-20	49068	49068
12	SPRING, SUSPENSION MEDIUM	42524	42524
13	SCREW 1/4-20X3/8 PN HD PH	42360	42360
14	10-24 TINNERMAM FASTENER	42221	42221

## Floss Pan and Whirlgrip Stabilizer

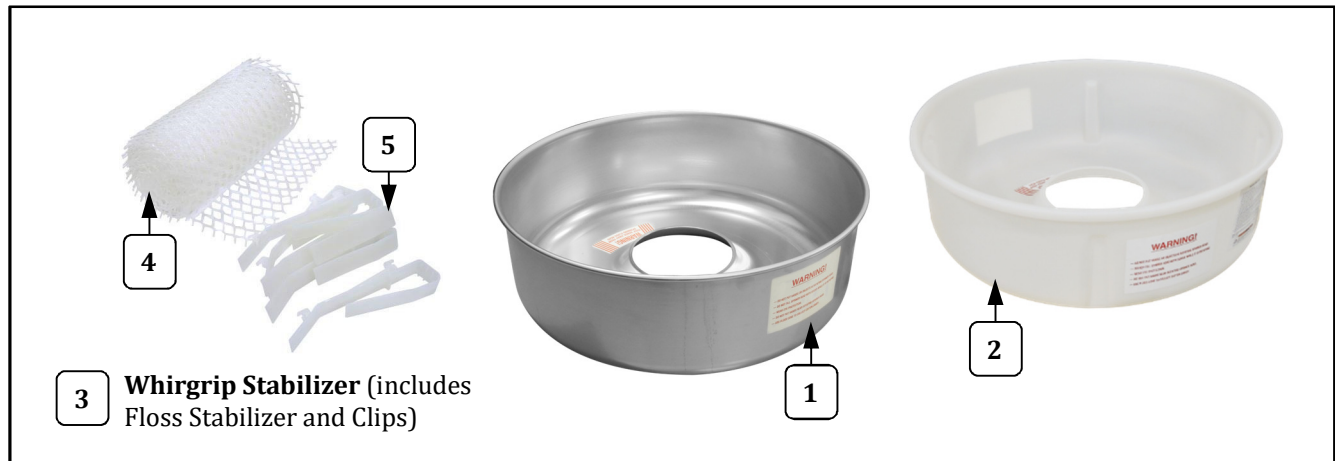

Item	Part Description	Part Number	
		3017-00-000	3024-00-000
1	FLOSS PAN (aluminum)	42040	
2	FLOSS PAN (non-metal)		42040NMR
3	WHIRLGRIP STABILIZER (Includes Floss Stabilizer and Clips)	3010	3010NM
4	FLOSS STABILIZER (Web)	43032	43032NM
5	WHIRLGRIP CLIPS	77470	77470

## Cabinet Interior - Parts List

Item	Part Description	Part Number	
		3017-00-000	3024-00-000
1	MOTOR, FLOSS MACHINE	48649	48649
2	SWITCH, LIGHTED ROCKER GR	42798	42798
3	ELECTRONIC HEAT CONTROL	42558	42558
4	6-32 X 3/8 PHIL PAN M/S	39000	39000
5	WASHER #6 INTERNAL TOOTH	76188	76188
6	RELAY, 120VAC, DPST-NO	48590	48590
7	6-32 GRIP NUT ZINC PLATED	47517	47517
8	TERMINAL BLOCK, 2 POS	55620	55620
9	8-32 X 3/4 PHIL PAN MS SS	39007	39007
10	HEX NUT #8-32 STAINLESS	89129	89129
11	ACORN NUT 1/4-20	49068	49068
12	SPRING, SUSPENSION MEDIUM	42524	42524
13	SCREW 1/4-20X3/8 PN HD PH	42360	42360
14	10-24 TINNERMAM FASTENER	42221	42221

## Floss Pan and Whirlgrip Stabilizer

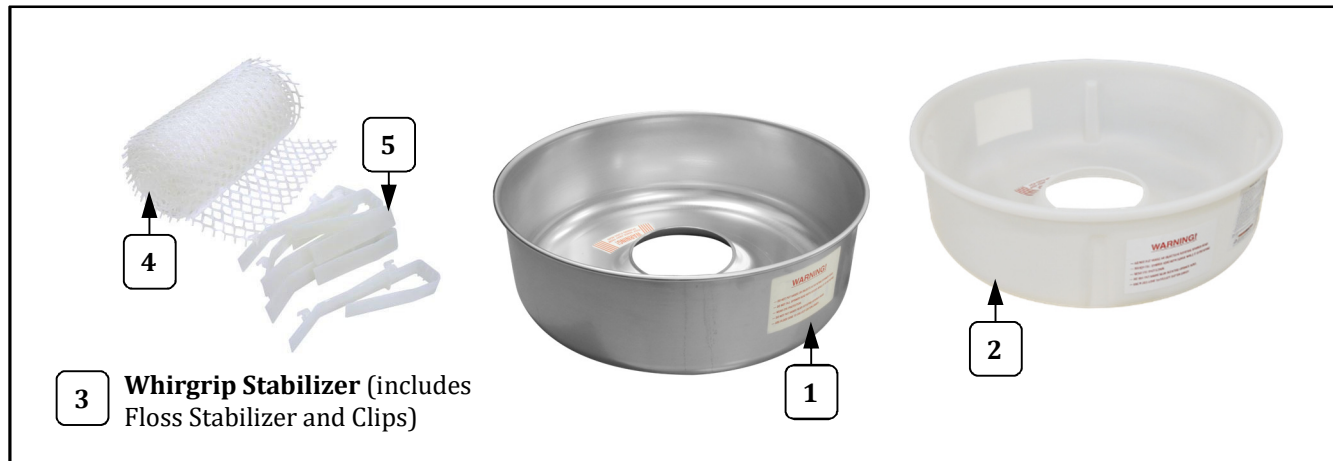

Item	Part Description	Part Number	
		3017-00-000	3024-00-000
1	FLOSS PAN (aluminum)	42040	
2	FLOSS PAN (non-metal)		42040NMR
3	WHIRLGRIP STABILIZER (Includes Floss Stabilizer and Clips)	3010	3010NM
4	FLOSS STABILIZER (Web)	43032	43032NM
5	WHIRLGRIP CLIPS	77470	77470

## Cabinet Interior - Parts List

Item	Part Description	Part Number	
		3017-00-000	3024-00-000
1	MOTOR, FLOSS MACHINE	48649	48649
2	SWITCH, LIGHTED ROCKER GR	42798	42798
3	ELECTRONIC HEAT CONTROL	42558	42558
4	6-32 X 3/8 PHIL PAN M/S	39000	39000
5	WASHER #6 INTERNAL TOOTH	76188	76188
6	RELAY, 120VAC, DPST-NO	48590	48590
7	6-32 GRIP NUT ZINC PLATED	47517	47517
8	TERMINAL BLOCK, 2 POS	55620	55620
9	8-32 X 3/4 PHIL PAN MS SS	39007	39007
10	HEX NUT #8-32 STAINLESS	89129	89129
11	ACORN NUT 1/4-20	49068	49068
12	SPRING, SUSPENSION MEDIUM	42524	42524
13	SCREW 1/4-20X3/8 PN HD PH	42360	42360
14	10-24 TINNERMAM FASTENER	42221	42221

## Floss Pan and Whirlgrip Stabilizer

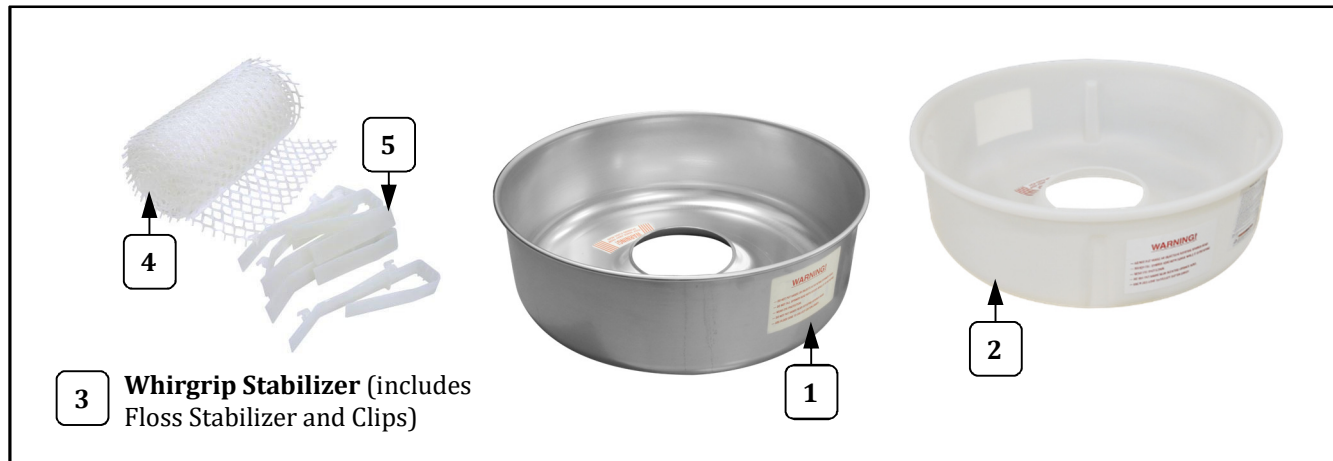

Item	Part Description	Part Number	
		3017-00-000	3024-00-000
1	FLOSS PAN (aluminum)	42040	
2	FLOSS PAN (non-metal)		42040NMR
3	WHIRLGRIP STABILIZER (Includes Floss Stabilizer and Clips)	3010	3010NM
4	FLOSS STABILIZER (Web)	43032	43032NM
5	WHIRLGRIP CLIPS	77470	77470

## Cabinet Interior - Parts List

Item	Part Description	Part Number	
		3017-00-000	3024-00-000
1	MOTOR, FLOSS MACHINE	48649	48649
2	SWITCH, LIGHTED ROCKER GR	42798	42798
3	ELECTRONIC HEAT CONTROL	42558	42558
4	6-32 X 3/8 PHIL PAN M/S	39000	39000
5	WASHER #6 INTERNAL TOOTH	76188	76188
6	RELAY, 120VAC, DPST-NO	48590	48590
7	6-32 GRIP NUT ZINC PLATED	47517	47517
8	TERMINAL BLOCK, 2 POS	55620	55620
9	8-32 X 3/4 PHIL PAN MS SS	39007	39007
10	HEX NUT #8-32 STAINLESS	89129	89129
11	ACORN NUT 1/4-20	49068	49068
12	SPRING, SUSPENSION MEDIUM	42524	42524
13	SCREW 1/4-20X3/8 PN HD PH	42360	42360
14	10-24 TINNERMAM FASTENER	42221	42221

## Floss Pan and Whirlgrip Stabilizer

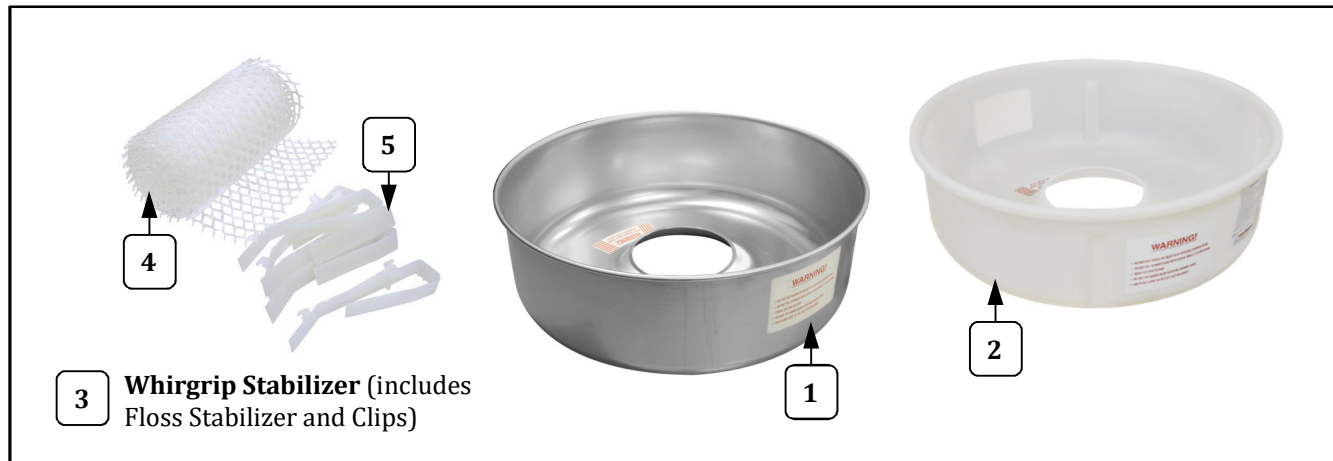

Item	Part Description	Part Number	
		3017-00-000	3024-00-000
1	FLOSS PAN (aluminum)	42040	
2	FLOSS PAN (non-metal)		42040NMR
3	WHIRLGRIP STABILIZER (Includes Floss Stabilizer and Clips)	3010	3010NM
4	FLOSS STABILIZER (Web)	43032	43032NM
5	WHIRLGRIP CLIPS	77470	77470

## Cabinet Interior - Parts List

Item	Part Description	Part Number	
		3017-00-000	3024-00-000
1	MOTOR, FLOSS MACHINE	48649	48649
2	SWITCH, LIGHTED ROCKER GR	42798	42798
3	ELECTRONIC HEAT CONTROL	42558	42558
4	6-32 X 3/8 PHIL PAN M/S	39000	39000
5	WASHER #6 INTERNAL TOOTH	76188	76188
6	RELAY, 120VAC, DPST-NO	48590	48590
7	6-32 GRIP NUT ZINC PLATED	47517	47517
8	TERMINAL BLOCK, 2 POS	55620	55620
9	8-32 X 3/4 PHIL PAN MS SS	39007	39007
10	HEX NUT #8-32 STAINLESS	89129	89129
11	ACORN NUT 1/4-20	49068	49068
12	SPRING, SUSPENSION MEDIUM	42524	42524
13	SCREW 1/4-20X3/8 PN HD PH	42360	42360
14	10-24 TINNERMAM FASTENER	42221	42221

## Floss Pan and Whirlgrip Stabilizer

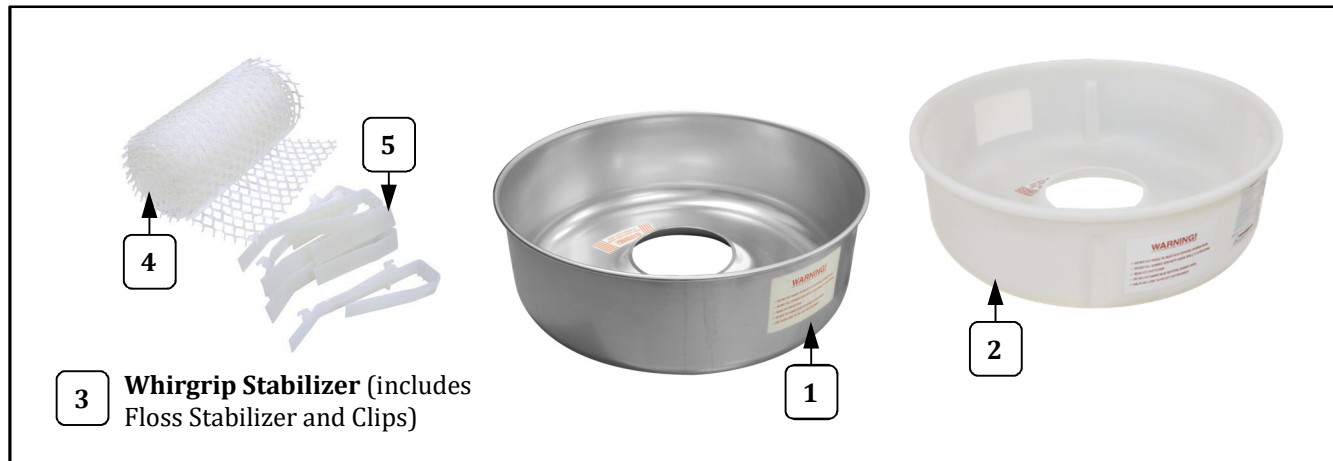

Item	Part Description	Part Number	
		3017-00-000	3024-00-000
1	FLOSS PAN (aluminum)	42040	
2	FLOSS PAN (non-metal)		42040NMR
3	WHIRLGRIP STABILIZER (Includes Floss Stabilizer and Clips)	3010	3010NM
4	FLOSS STABILIZER (Web)	43032	43032NM
5	WHIRLGRIP CLIPS	77470	77470

## Cabinet Interior - Parts List

Item	Part Description	Part Number	
		3017-00-000	3024-00-000
1	MOTOR, FLOSS MACHINE	48649	48649
2	SWITCH, LIGHTED ROCKER GR	42798	42798
3	ELECTRONIC HEAT CONTROL	42558	42558
4	6-32 X 3/8 PHIL PAN M/S	39000	39000
5	WASHER #6 INTERNAL TOOTH	76188	76188
6	RELAY, 120VAC, DPST-NO	48590	48590
7	6-32 GRIP NUT ZINC PLATED	47517	47517
8	TERMINAL BLOCK, 2 POS	55620	55620
9	8-32 X 3/4 PHIL PAN MS SS	39007	39007
10	HEX NUT #8-32 STAINLESS	89129	89129
11	ACORN NUT 1/4-20	49068	49068
12	SPRING, SUSPENSION MEDIUM	42524	42524
13	SCREW 1/4-20X3/8 PN HD PH	42360	42360
14	10-24 TINNERMAM FASTENER	42221	42221

## Floss Pan and Whirlgrip Stabilizer

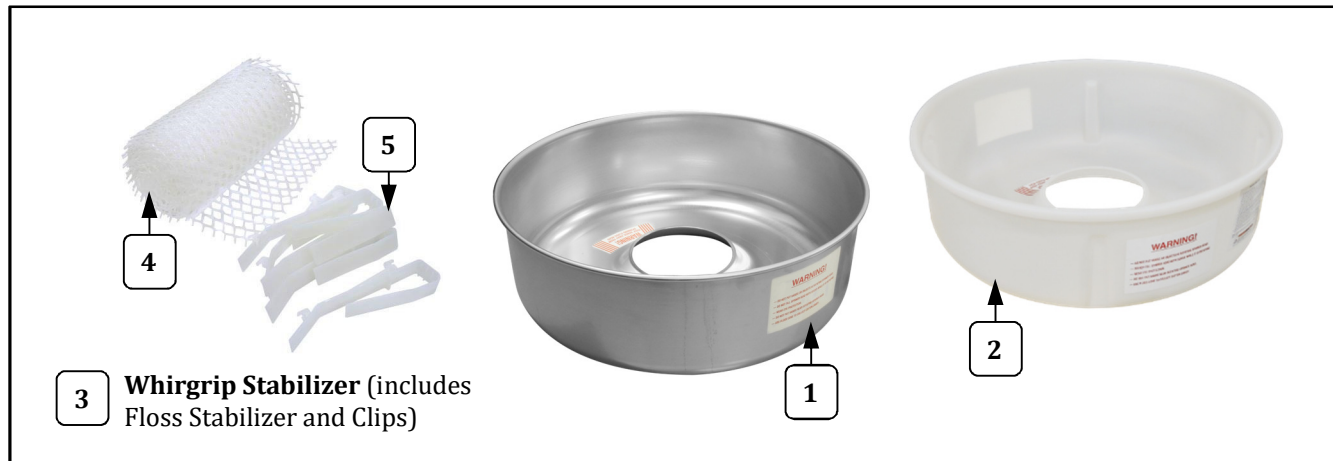

Item	Part Description	Part Number	
		3017-00-000	3024-00-000
1	FLOSS PAN (aluminum)	42040	
2	FLOSS PAN (non-metal)		42040NMR
3	WHIRLGRIP STABILIZER (Includes Floss Stabilizer and Clips)	3010	3010NM
4	FLOSS STABILIZER (Web)	43032	43032NM
5	WHIRLGRIP CLIPS	77470	77470

## Cabinet Interior - Parts List

Item	Part Description	Part Number	
		3017-00-000	3024-00-000
1	MOTOR, FLOSS MACHINE	48649	48649
2	SWITCH, LIGHTED ROCKER GR	42798	42798
3	ELECTRONIC HEAT CONTROL	42558	42558
4	6-32 X 3/8 PHIL PAN M/S	39000	39000
5	WASHER #6 INTERNAL TOOTH	76188	76188
6	RELAY, 120VAC, DPST-NO	48590	48590
7	6-32 GRIP NUT ZINC PLATED	47517	47517
8	TERMINAL BLOCK, 2 POS	55620	55620
9	8-32 X 3/4 PHIL PAN MS SS	39007	39007
10	HEX NUT #8-32 STAINLESS	89129	89129
11	ACORN NUT 1/4-20	49068	49068
12	SPRING, SUSPENSION MEDIUM	42524	42524
13	SCREW 1/4-20X3/8 PN HD PH	42360	42360
14	10-24 TINNERMAM FASTENER	42221	42221

## Floss Pan and Whirlgrip Stabilizer

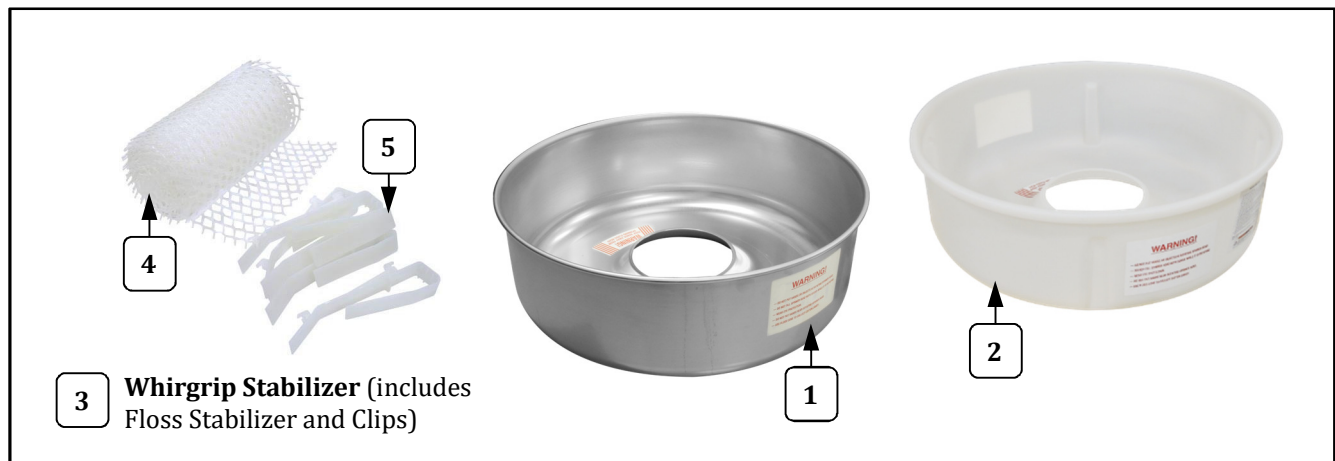

Item	Part Description	Part Number	
		3017-00-000	3024-00-000
1	FLOSS PAN (aluminum)	42040	
2	FLOSS PAN (non-metal)		42040NMR
3	WHIRLGRIP STABILIZER (Includes Floss Stabilizer and Clips)	3010	3010NM
4	FLOSS STABILIZER (Web)	43032	43032NM
5	WHIRLGRIP CLIPS	77470	77470

## Cabinet Interior - Parts List

Item	Part Description	Part Number	
		3017-00-000	3024-00-000
1	MOTOR, FLOSS MACHINE	48649	48649
2	SWITCH, LIGHTED ROCKER GR	42798	42798
3	ELECTRONIC HEAT CONTROL	42558	42558
4	6-32 X 3/8 PHIL PAN M/S	39000	39000
5	WASHER #6 INTERNAL TOOTH	76188	76188
6	RELAY, 120VAC, DPST-NO	48590	48590
7	6-32 GRIP NUT ZINC PLATED	47517	47517
8	TERMINAL BLOCK, 2 POS	55620	55620
9	8-32 X 3/4 PHIL PAN MS SS	39007	39007
10	HEX NUT #8-32 STAINLESS	89129	89129
11	ACORN NUT 1/4-20	49068	49068
12	SPRING, SUSPENSION MEDIUM	42524	42524
13	SCREW 1/4-20X3/8 PN HD PH	42360	42360
14	10-24 TINNERMAM FASTENER	42221	42221

## Floss Pan and Whirlgrip Stabilizer

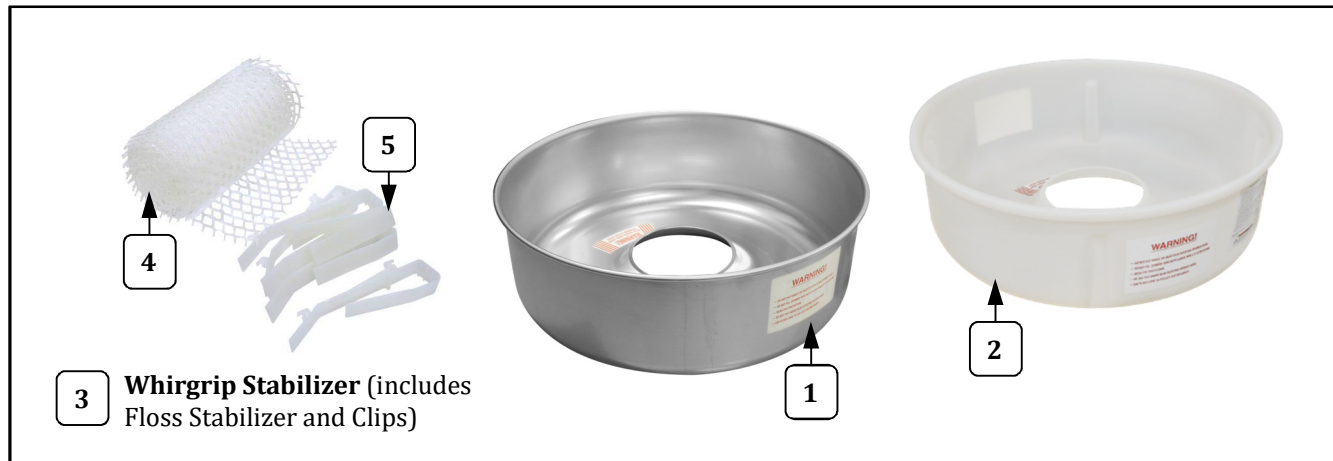

Item	Part Description	Part Number	
		3017-00-000	3024-00-000
1	FLOSS PAN (aluminum)	42040	
2	FLOSS PAN (non-metal)		42040NMR
3	WHIRLGRIP STABILIZER (Includes Floss Stabilizer and Clips)	3010	3010NM
4	FLOSS STABILIZER (Web)	43032	43032NM
5	WHIRLGRIP CLIPS	77470	77470

## Cabinet Interior - Parts List

Item	Part Description	Part Number	
		3017-00-000	3024-00-000
1	MOTOR, FLOSS MACHINE	48649	48649
2	SWITCH, LIGHTED ROCKER GR	42798	42798
3	ELECTRONIC HEAT CONTROL	42558	42558
4	6-32 X 3/8 PHIL PAN M/S	39000	39000
5	WASHER #6 INTERNAL TOOTH	76188	76188
6	RELAY, 120VAC, DPST-NO	48590	48590
7	6-32 GRIP NUT ZINC PLATED	47517	47517
8	TERMINAL BLOCK, 2 POS	55620	55620
9	8-32 X 3/4 PHIL PAN MS SS	39007	39007
10	HEX NUT #8-32 STAINLESS	89129	89129
11	ACORN NUT 1/4-20	49068	49068
12	SPRING, SUSPENSION MEDIUM	42524	42524
13	SCREW 1/4-20X3/8 PN HD PH	42360	42360
14	10-24 TINNERMAM FASTENER	42221	42221

## Floss Pan and Whirlgrip Stabilizer

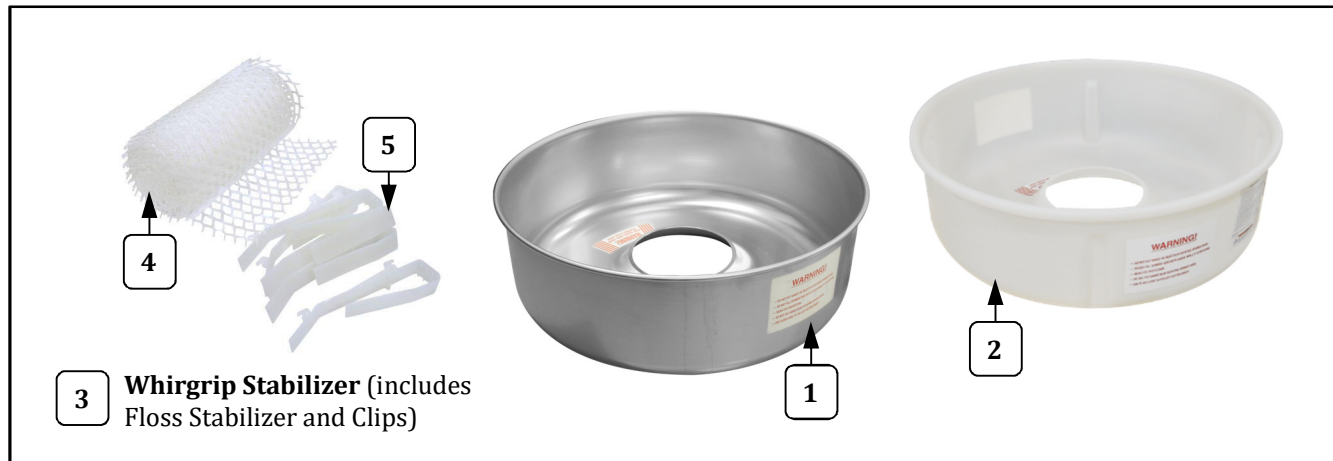

Item	Part Description	Part Number	
		3017-00-000	3024-00-000
1	FLOSS PAN (aluminum)	42040	
2	FLOSS PAN (non-metal)		42040NMR
3	WHIRLGRIP STABILIZER (Includes Floss Stabilizer and Clips)	3010	3010NM
4	FLOSS STABILIZER (Web)	43032	43032NM
5	WHIRLGRIP CLIPS	77470	77470

## Cabinet Interior - Parts List

Item	Part Description	Part Number	
		3017-00-000	3024-00-000
1	MOTOR, FLOSS MACHINE	48649	48649
2	SWITCH, LIGHTED ROCKER GR	42798	42798
3	ELECTRONIC HEAT CONTROL	42558	42558
4	6-32 X 3/8 PHIL PAN M/S	39000	39000
5	WASHER #6 INTERNAL TOOTH	76188	76188
6	RELAY, 120VAC, DPST-NO	48590	48590
7	6-32 GRIP NUT ZINC PLATED	47517	47517
8	TERMINAL BLOCK, 2 POS	55620	55620
9	8-32 X 3/4 PHIL PAN MS SS	39007	39007
10	HEX NUT #8-32 STAINLESS	89129	89129
11	ACORN NUT 1/4-20	49068	49068
12	SPRING, SUSPENSION MEDIUM	42524	42524
13	SCREW 1/4-20X3/8 PN HD PH	42360	42360
14	10-24 TINNERMAM FASTENER	42221	42221

## Floss Pan and Whirlgrip Stabilizer

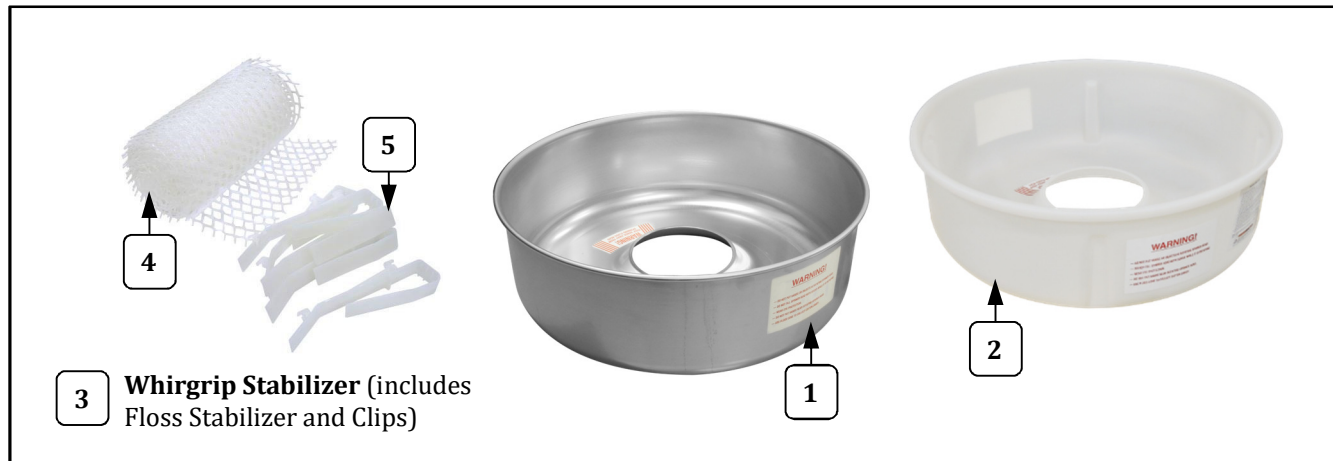

Item	Part Description	Part Number	
		3017-00-000	3024-00-000
1	FLOSS PAN (aluminum)	42040	
2	FLOSS PAN (non-metal)		42040NMR
3	WHIRLGRIP STABILIZER (Includes Floss Stabilizer and Clips)	3010	3010NM
4	FLOSS STABILIZER (Web)	43032	43032NM
5	WHIRLGRIP CLIPS	77470	77470

## Cabinet Interior - Parts List

Item	Part Description	Part Number	
		3017-00-000	3024-00-000
1	MOTOR, FLOSS MACHINE	48649	48649
2	SWITCH, LIGHTED ROCKER GR	42798	42798
3	ELECTRONIC HEAT CONTROL	42558	42558
4	6-32 X 3/8 PHIL PAN M/S	39000	39000
5	WASHER #6 INTERNAL TOOTH	76188	76188
6	RELAY, 120VAC, DPST-NO	48590	48590
7	6-32 GRIP NUT ZINC PLATED	47517	47517
8	TERMINAL BLOCK, 2 POS	55620	55620
9	8-32 X 3/4 PHIL PAN MS SS	39007	39007
10	HEX NUT #8-32 STAINLESS	89129	89129
11	ACORN NUT 1/4-20	49068	49068
12	SPRING, SUSPENSION MEDIUM	42524	42524
13	SCREW 1/4-20X3/8 PN HD PH	42360	42360
14	10-24 TINNERMAM FASTENER	42221	42221

## Floss Pan and Whirlgrip Stabilizer

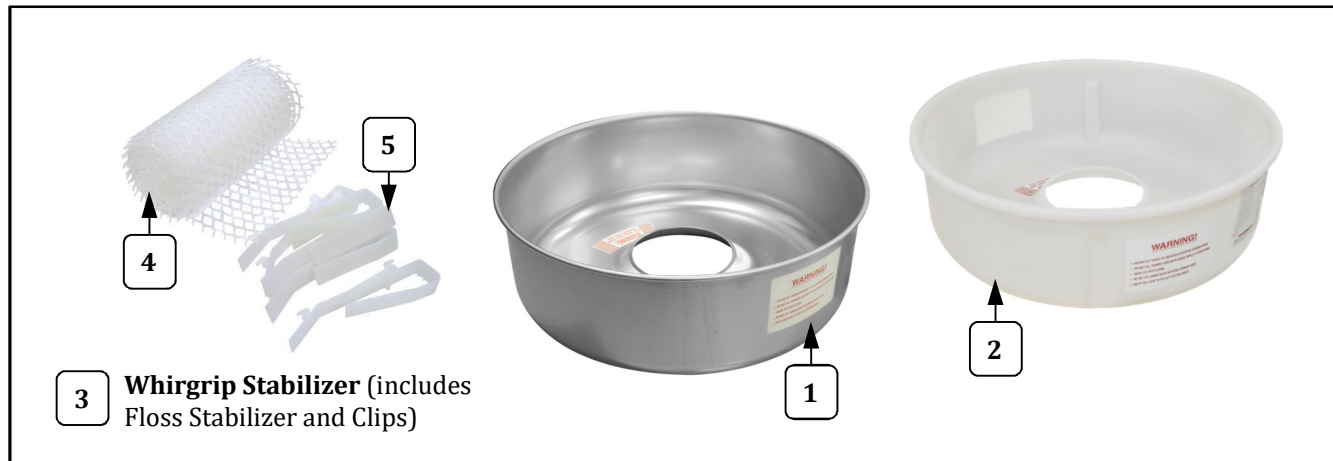

Item	Part Description	Part Number	
		3017-00-000	3024-00-000
1	FLOSS PAN (aluminum)	42040	
2	FLOSS PAN (non-metal)		42040NMR
3	WHIRLGRIP STABILIZER (Includes Floss Stabilizer and Clips)	3010	3010NM
4	FLOSS STABILIZER (Web)	43032	43032NM
5	WHIRLGRIP CLIPS	77470	77470

## Cabinet Interior - Parts List

Item	Part Description	Part Number	
		3017-00-000	3024-00-000
1	MOTOR, FLOSS MACHINE	48649	48649
2	SWITCH, LIGHTED ROCKER GR	42798	42798
3	ELECTRONIC HEAT CONTROL	42558	42558
4	6-32 X 3/8 PHIL PAN M/S	39000	39000
5	WASHER #6 INTERNAL TOOTH	76188	76188
6	RELAY, 120VAC, DPST-NO	48590	48590
7	6-32 GRIP NUT ZINC PLATED	47517	47517
8	TERMINAL BLOCK, 2 POS	55620	55620
9	8-32 X 3/4 PHIL PAN MS SS	39007	39007
10	HEX NUT #8-32 STAINLESS	89129	89129
11	ACORN NUT 1/4-20	49068	49068
12	SPRING, SUSPENSION MEDIUM	42524	42524
13	SCREW 1/4-20X3/8 PN HD PH	42360	42360
14	10-24 TINNERMAM FASTENER	42221	42221

## Floss Pan and Whirlgrip Stabilizer

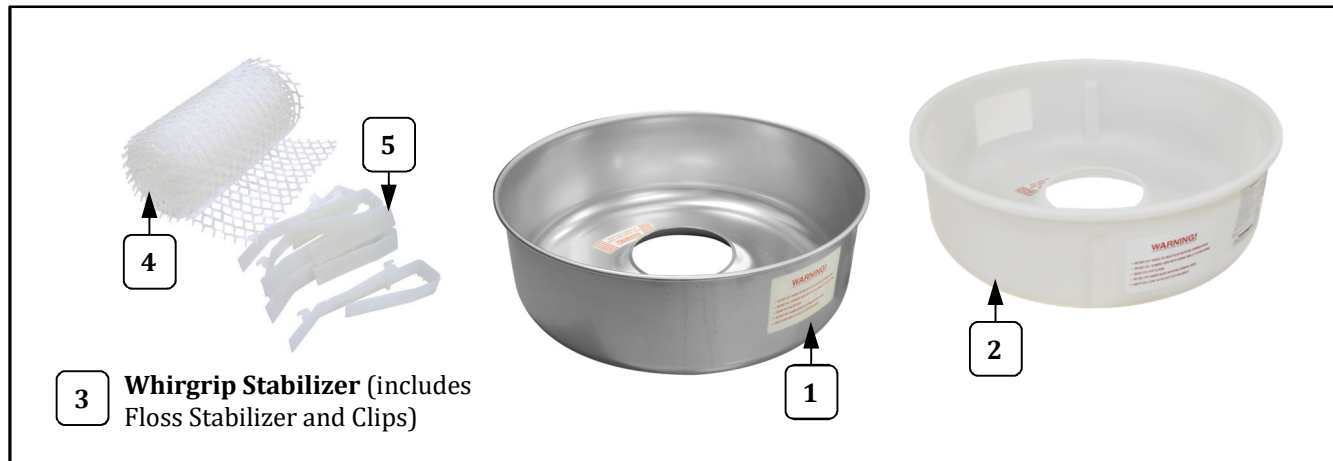

Item	Part Description	Part Number	
		3017-00-000	3024-00-000
1	FLOSS PAN (aluminum)	42040	
2	FLOSS PAN (non-metal)		42040NMR
3	WHIRLGRIP STABILIZER (Includes Floss Stabilizer and Clips)	3010	3010NM
4	FLOSS STABILIZER (Web)	43032	43032NM
5	WHIRLGRIP CLIPS	77470	77470

## Cabinet Interior - Parts List

Item	Part Description	Part Number	
		3017-00-000	3024-00-000
1	MOTOR, FLOSS MACHINE	48649	48649
2	SWITCH, LIGHTED ROCKER GR	42798	42798
3	ELECTRONIC HEAT CONTROL	42558	42558
4	6-32 X 3/8 PHIL PAN M/S	39000	39000
5	WASHER #6 INTERNAL TOOTH	76188	76188
6	RELAY, 120VAC, DPST-NO	48590	48590
7	6-32 GRIP NUT ZINC PLATED	47517	47517
8	TERMINAL BLOCK, 2 POS	55620	55620
9	8-32 X 3/4 PHIL PAN MS SS	39007	39007
10	HEX NUT #8-32 STAINLESS	89129	89129
11	ACORN NUT 1/4-20	49068	49068
12	SPRING, SUSPENSION MEDIUM	42524	42524
13	SCREW 1/4-20X3/8 PN HD PH	42360	42360
14	10-24 TINNERMAM FASTENER	42221	42221

## Floss Pan and Whirlgrip Stabilizer

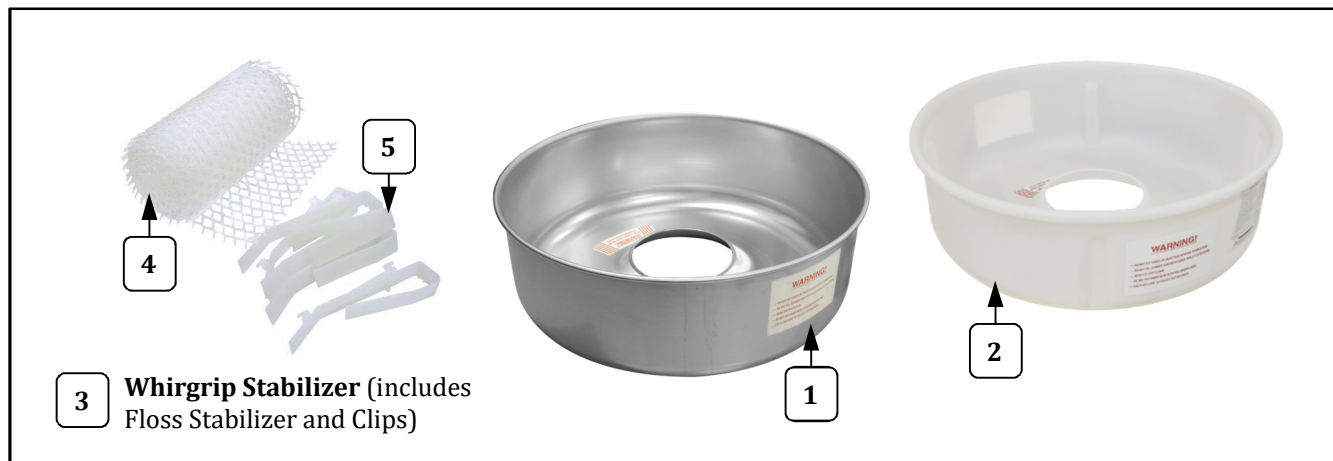

Item	Part Description	Part Number	
		3017-00-000	3024-00-000
1	FLOSS PAN (aluminum)	42040	
2	FLOSS PAN (non-metal)		42040NMR
3	WHIRLGRIP STABILIZER (Includes Floss Stabilizer and Clips)	3010	3010NM
4	FLOSS STABILIZER (Web)	43032	43032NM
5	WHIRLGRIP CLIPS	77470	77470

## Cabinet Interior - Parts List

Item	Part Description	Part Number	
		3017-00-000	3024-00-000
1	MOTOR, FLOSS MACHINE	48649	48649
2	SWITCH, LIGHTED ROCKER GR	42798	42798
3	ELECTRONIC HEAT CONTROL	42558	42558
4	6-32 X 3/8 PHIL PAN M/S	39000	39000
5	WASHER #6 INTERNAL TOOTH	76188	76188
6	RELAY, 120VAC, DPST-NO	48590	48590
7	6-32 GRIP NUT ZINC PLATED	47517	47517
8	TERMINAL BLOCK, 2 POS	55620	55620
9	8-32 X 3/4 PHIL PAN MS SS	39007	39007
10	HEX NUT #8-32 STAINLESS	89129	89129
11	ACORN NUT 1/4-20	49068	49068
12	SPRING, SUSPENSION MEDIUM	42524	42524
13	SCREW 1/4-20X3/8 PN HD PH	42360	42360
14	10-24 TINNERMAM FASTENER	42221	42221

## Floss Pan and Whirlgrip Stabilizer

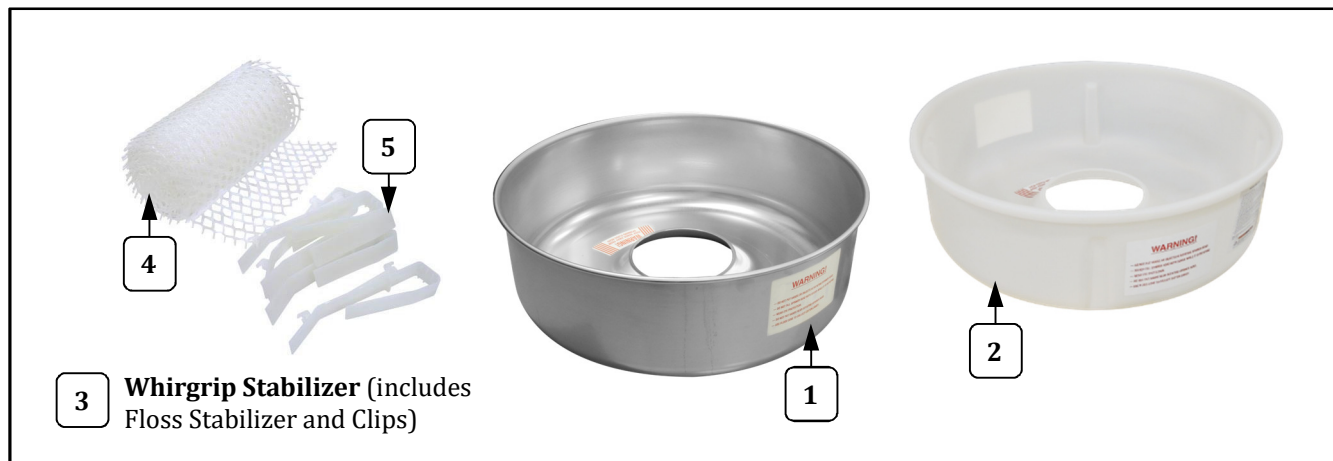

Item	Part Description	Part Number	
		3017-00-000	3024-00-000
1	FLOSS PAN (aluminum)	42040	
2	FLOSS PAN (non-metal)		42040NMR
3	WHIRLGRIP STABILIZER (Includes Floss Stabilizer and Clips)	3010	3010NM
4	FLOSS STABILIZER (Web)	43032	43032NM
5	WHIRLGRIP CLIPS	77470	77470

## Cabinet Interior - Parts List

Item	Part Description	Part Number	
		3017-00-000	3024-00-000
1	MOTOR, FLOSS MACHINE	48649	48649
2	SWITCH, LIGHTED ROCKER GR	42798	42798
3	ELECTRONIC HEAT CONTROL	42558	42558
4	6-32 X 3/8 PHIL PAN M/S	39000	39000
5	WASHER #6 INTERNAL TOOTH	76188	76188
6	RELAY, 120VAC, DPST-NO	48590	48590
7	6-32 GRIP NUT ZINC PLATED	47517	47517
8	TERMINAL BLOCK, 2 POS	55620	55620
9	8-32 X 3/4 PHIL PAN MS SS	39007	39007
10	HEX NUT #8-32 STAINLESS	89129	89129
11	ACORN NUT 1/4-20	49068	49068
12	SPRING, SUSPENSION MEDIUM	42524	42524
13	SCREW 1/4-20X3/8 PN HD PH	42360	42360
14	10-24 TINNERMAM FASTENER	42221	42221

## Floss Pan and Whirlgrip Stabilizer

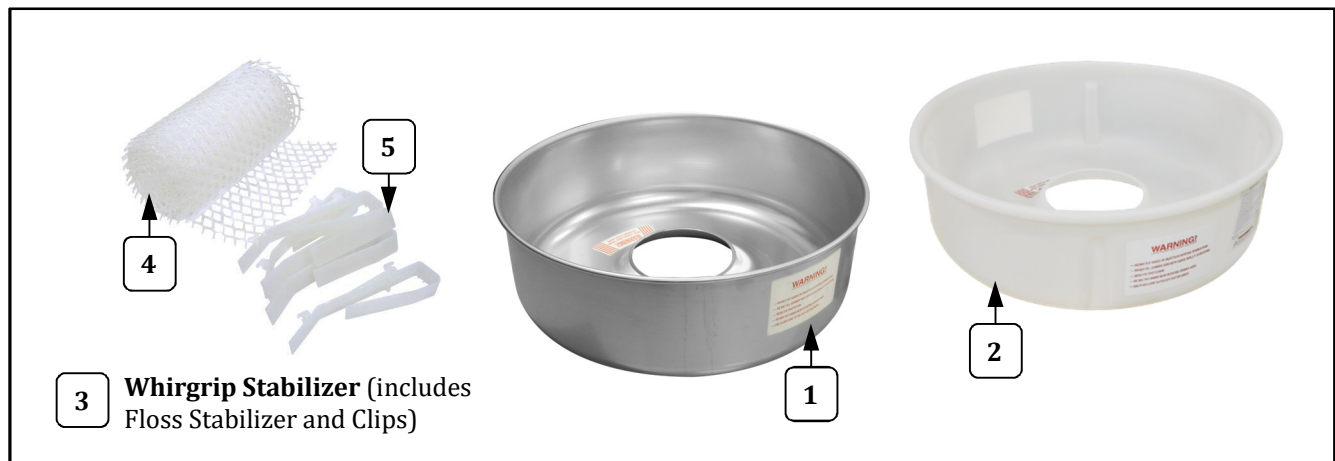

Item	Part Description	Part Number	
		3017-00-000	3024-00-000
1	FLOSS PAN (aluminum)	42040	
2	FLOSS PAN (non-metal)		42040NMR
3	WHIRLGRIP STABILIZER (Includes Floss Stabilizer and Clips)	3010	3010NM
4	FLOSS STABILIZER (Web)	43032	43032NM
5	WHIRLGRIP CLIPS	77470	77470

## Cabinet Interior - Parts List

Item	Part Description	Part Number	
		3017-00-000	3024-00-000
1	MOTOR, FLOSS MACHINE	48649	48649
2	SWITCH, LIGHTED ROCKER GR	42798	42798
3	ELECTRONIC HEAT CONTROL	42558	42558
4	6-32 X 3/8 PHIL PAN M/S	39000	39000
5	WASHER #6 INTERNAL TOOTH	76188	76188
6	RELAY, 120VAC, DPST-NO	48590	48590
7	6-32 GRIP NUT ZINC PLATED	47517	47517
8	TERMINAL BLOCK, 2 POS	55620	55620
9	8-32 X 3/4 PHIL PAN MS SS	39007	39007
10	HEX NUT #8-32 STAINLESS	89129	89129
11	ACORN NUT 1/4-20	49068	49068
12	SPRING, SUSPENSION MEDIUM	42524	42524
13	SCREW 1/4-20X3/8 PN HD PH	42360	42360
14	10-24 TINNERMAM FASTENER	42221	42221

## Floss Pan and Whirlgrip Stabilizer

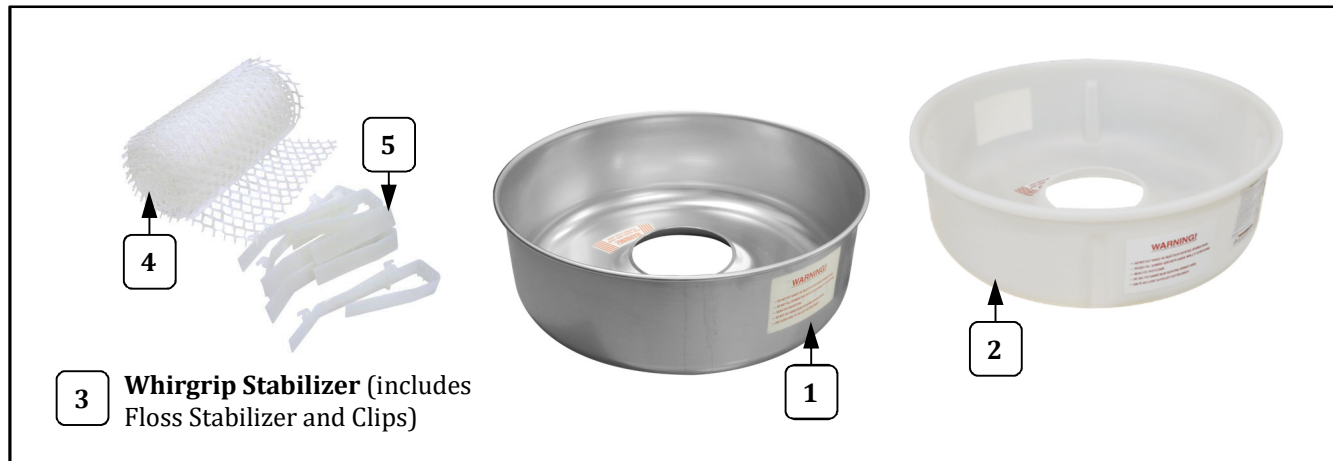

Item	Part Description	Part Number	
		3017-00-000	3024-00-000
1	FLOSS PAN (aluminum)	42040	
2	FLOSS PAN (non-metal)		42040NMR
3	WHIRLGRIP STABILIZER (Includes Floss Stabilizer and Clips)	3010	3010NM
4	FLOSS STABILIZER (Web)	43032	43032NM
5	WHIRLGRIP CLIPS	77470	77470

## Cabinet Interior - Parts List

Item	Part Description	Part Number	
		3017-00-000	3024-00-000
1	MOTOR, FLOSS MACHINE	48649	48649
2	SWITCH, LIGHTED ROCKER GR	42798	42798
3	ELECTRONIC HEAT CONTROL	42558	42558
4	6-32 X 3/8 PHIL PAN M/S	39000	39000
5	WASHER #6 INTERNAL TOOTH	76188	76188
6	RELAY, 120VAC, DPST-NO	48590	48590
7	6-32 GRIP NUT ZINC PLATED	47517	47517
8	TERMINAL BLOCK, 2 POS	55620	55620
9	8-32 X 3/4 PHIL PAN MS SS	39007	39007
10	HEX NUT #8-32 STAINLESS	89129	89129
11	ACORN NUT 1/4-20	49068	49068
12	SPRING, SUSPENSION MEDIUM	42524	42524
13	SCREW 1/4-20X3/8 PN HD PH	42360	42360
14	10-24 TINNERMAM FASTENER	42221	42221

## Floss Pan and Whirlgrip Stabilizer

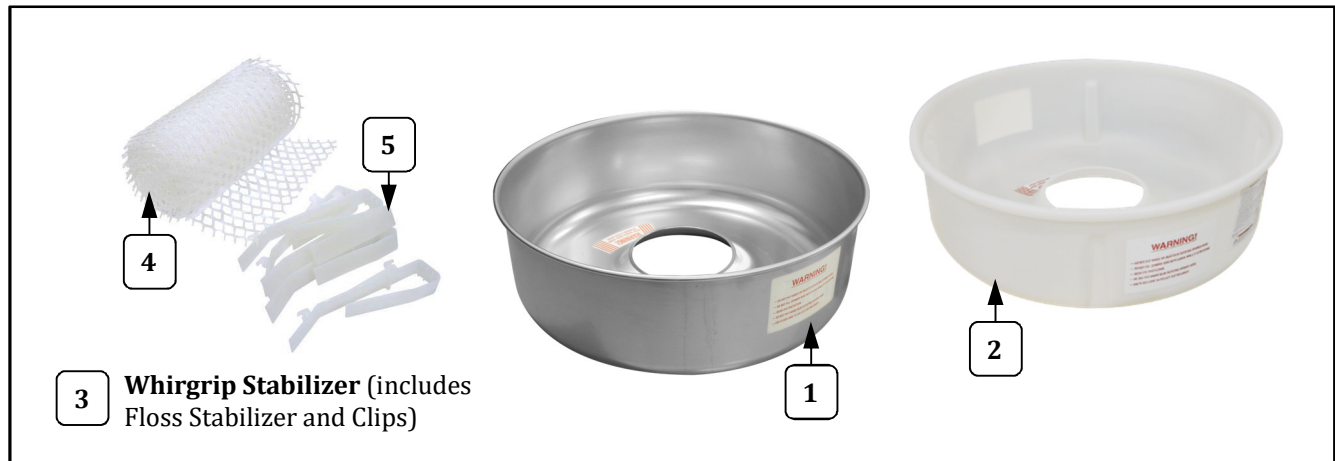

Item	Part Description	Part Number	
		3017-00-000	3024-00-000
1	FLOSS PAN (aluminum)	42040	
2	FLOSS PAN (non-metal)		42040NMR
3	WHIRLGRIP STABILIZER (Includes Floss Stabilizer and Clips)	3010	3010NM
4	FLOSS STABILIZER (Web)	43032	43032NM
5	WHIRLGRIP CLIPS	77470	77470

## Cabinet Interior - Parts List

Item	Part Description	Part Number	
		3017-00-000	3024-00-000
1	MOTOR, FLOSS MACHINE	48649	48649
2	SWITCH, LIGHTED ROCKER GR	42798	42798
3	ELECTRONIC HEAT CONTROL	42558	42558
4	6-32 X 3/8 PHIL PAN M/S	39000	39000
5	WASHER #6 INTERNAL TOOTH	76188	76188
6	RELAY, 120VAC, DPST-NO	48590	48590
7	6-32 GRIP NUT ZINC PLATED	47517	47517
8	TERMINAL BLOCK, 2 POS	55620	55620
9	8-32 X 3/4 PHIL PAN MS SS	39007	39007
10	HEX NUT #8-32 STAINLESS	89129	89129
11	ACORN NUT 1/4-20	49068	49068
12	SPRING, SUSPENSION MEDIUM	42524	42524
13	SCREW 1/4-20X3/8 PN HD PH	42360	42360
14	10-24 TINNERMAM FASTENER	42221	42221

## Floss Pan and Whirlgrip Stabilizer

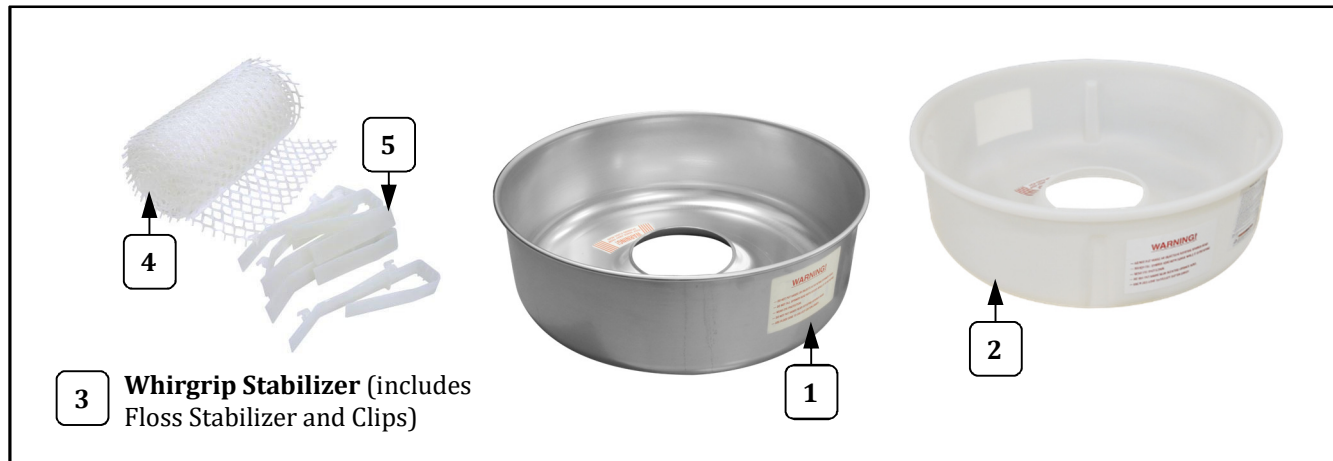

Item	Part Description	Part Number	
		3017-00-000	3024-00-000
1	FLOSS PAN (aluminum)	42040	
2	FLOSS PAN (non-metal)		42040NMR
3	WHIRLGRIP STABILIZER (Includes Floss Stabilizer and Clips)	3010	3010NM
4	FLOSS STABILIZER (Web)	43032	43032NM
5	WHIRLGRIP CLIPS	77470	77470

## Cabinet Interior - Parts List

Item	Part Description	Part Number	
		3017-00-000	3024-00-000
1	MOTOR, FLOSS MACHINE	48649	48649
2	SWITCH, LIGHTED ROCKER GR	42798	42798
3	ELECTRONIC HEAT CONTROL	42558	42558
4	6-32 X 3/8 PHIL PAN M/S	39000	39000
5	WASHER #6 INTERNAL TOOTH	76188	76188
6	RELAY, 120VAC, DPST-NO	48590	48590
7	6-32 GRIP NUT ZINC PLATED	47517	47517
8	TERMINAL BLOCK, 2 POS	55620	55620
9	8-32 X 3/4 PHIL PAN MS SS	39007	39007
10	HEX NUT #8-32 STAINLESS	89129	89129
11	ACORN NUT 1/4-20	49068	49068
12	SPRING, SUSPENSION MEDIUM	42524	42524
13	SCREW 1/4-20X3/8 PN HD PH	42360	42360
14	10-24 TINNERMAM FASTENER	42221	42221

## Floss Pan and Whirlgrip Stabilizer

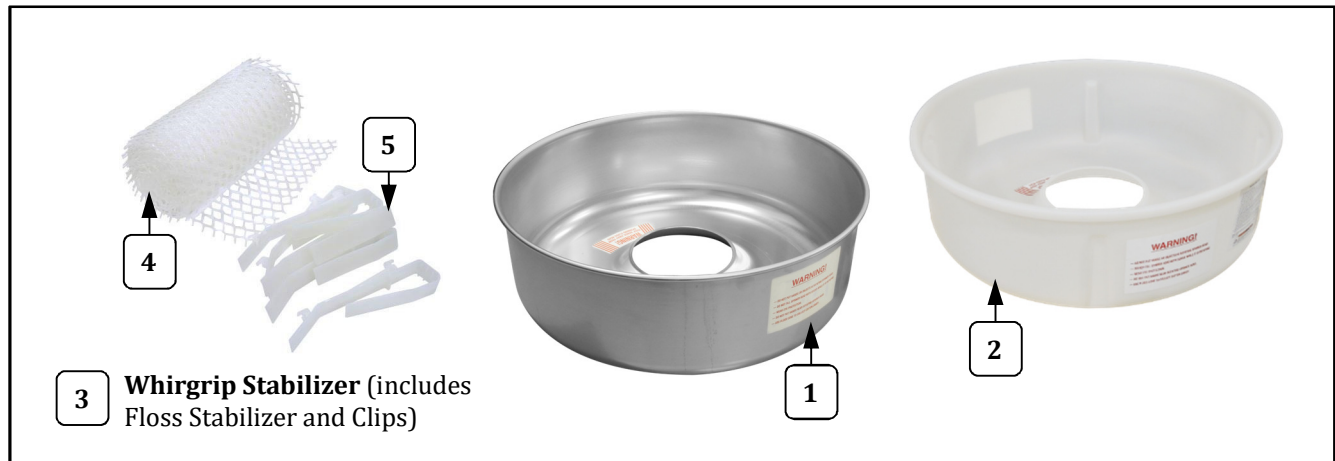

Item	Part Description	Part Number	
		3017-00-000	3024-00-000
1	FLOSS PAN (aluminum)	42040	
2	FLOSS PAN (non-metal)		42040NMR
3	WHIRLGRIP STABILIZER (Includes Floss Stabilizer and Clips)	3010	3010NM
4	FLOSS STABILIZER (Web)	43032	43032NM
5	WHIRLGRIP CLIPS	77470	77470

## Cabinet Interior - Parts List

Item	Part Description	Part Number	
		3017-00-000	3024-00-000
1	MOTOR, FLOSS MACHINE	48649	48649
2	SWITCH, LIGHTED ROCKER GR	42798	42798
3	ELECTRONIC HEAT CONTROL	42558	42558
4	6-32 X 3/8 PHIL PAN M/S	39000	39000
5	WASHER #6 INTERNAL TOOTH	76188	76188
6	RELAY, 120VAC, DPST-NO	48590	48590
7	6-32 GRIP NUT ZINC PLATED	47517	47517
8	TERMINAL BLOCK, 2 POS	55620	55620
9	8-32 X 3/4 PHIL PAN MS SS	39007	39007
10	HEX NUT #8-32 STAINLESS	89129	89129
11	ACORN NUT 1/4-20	49068	49068
12	SPRING, SUSPENSION MEDIUM	42524	42524
13	SCREW 1/4-20X3/8 PN HD PH	42360	42360
14	10-24 TINNERMAM FASTENER	42221	42221

## Floss Pan and Whirlgrip Stabilizer

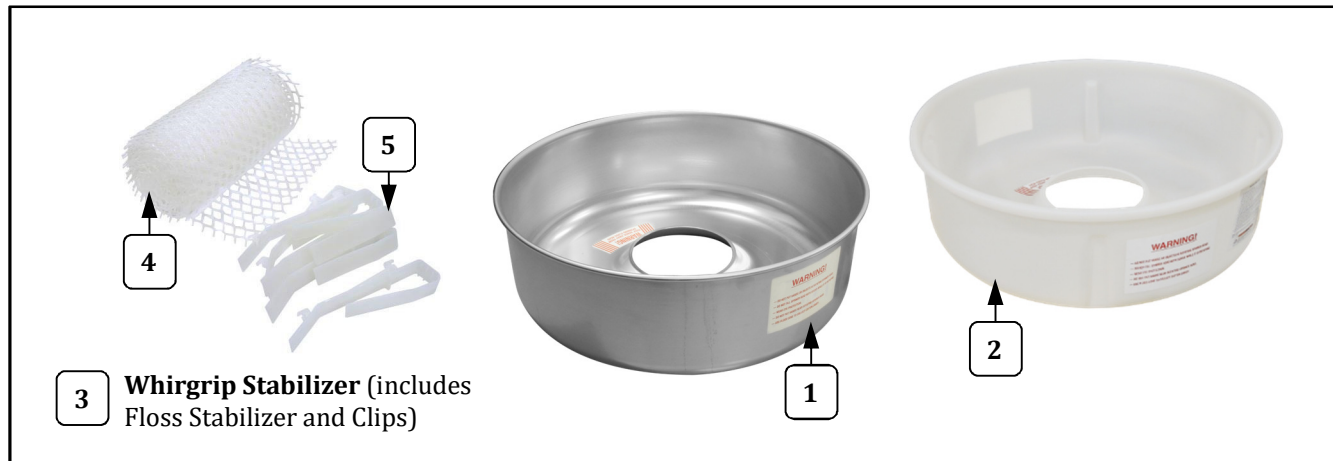

Item	Part Description	Part Number	
		3017-00-000	3024-00-000
1	FLOSS PAN (aluminum)	42040	
2	FLOSS PAN (non-metal)		42040NMR
3	WHIRLGRIP STABILIZER (Includes Floss Stabilizer and Clips)	3010	3010NM
4	FLOSS STABILIZER (Web)	43032	43032NM
5	WHIRLGRIP CLIPS	77470	77470

## Cabinet Interior - Parts List

Item	Part Description	Part Number	
		3017-00-000	3024-00-000
1	MOTOR, FLOSS MACHINE	48649	48649
2	SWITCH, LIGHTED ROCKER GR	42798	42798
3	ELECTRONIC HEAT CONTROL	42558	42558
4	6-32 X 3/8 PHIL PAN M/S	39000	39000
5	WASHER #6 INTERNAL TOOTH	76188	76188
6	RELAY, 120VAC, DPST-NO	48590	48590
7	6-32 GRIP NUT ZINC PLATED	47517	47517
8	TERMINAL BLOCK, 2 POS	55620	55620
9	8-32 X 3/4 PHIL PAN MS SS	39007	39007
10	HEX NUT #8-32 STAINLESS	89129	89129
11	ACORN NUT 1/4-20	49068	49068
12	SPRING, SUSPENSION MEDIUM	42524	42524
13	SCREW 1/4-20X3/8 PN HD PH	42360	42360
14	10-24 TINNERMAM FASTENER	42221	42221

## Floss Pan and Whirlgrip Stabilizer

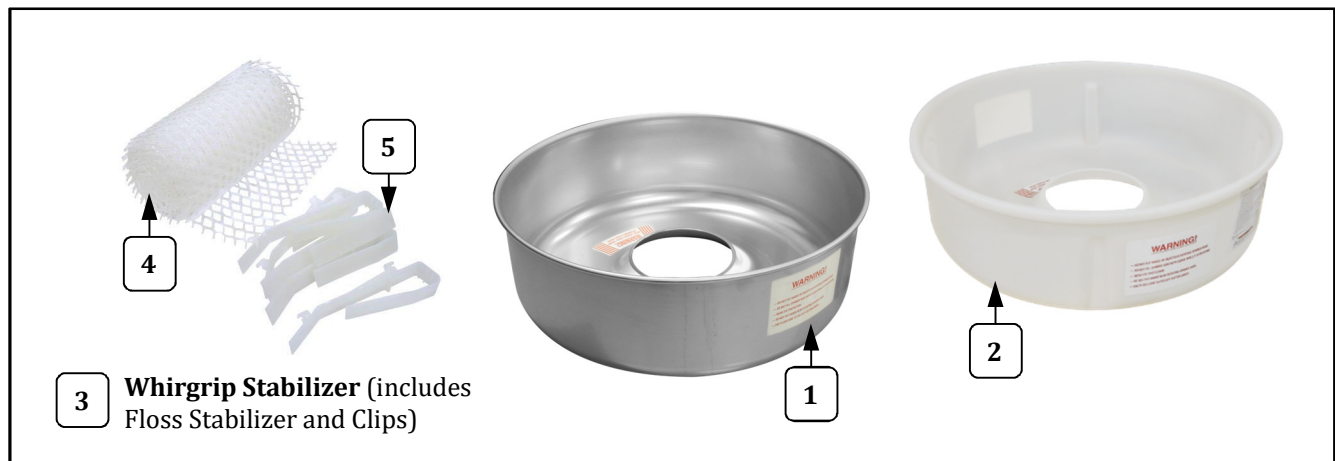

Item	Part Description	Part Number	
		3017-00-000	3024-00-000
1	FLOSS PAN (aluminum)	42040	
2	FLOSS PAN (non-metal)		42040NMR
3	WHIRLGRIP STABILIZER (Includes Floss Stabilizer and Clips)	3010	3010NM
4	FLOSS STABILIZER (Web)	43032	43032NM
5	WHIRLGRIP CLIPS	77470	77470

## Cabinet Interior - Parts List

Item	Part Description	Part Number	
		3017-00-000	3024-00-000
1	MOTOR, FLOSS MACHINE	48649	48649
2	SWITCH, LIGHTED ROCKER GR	42798	42798
3	ELECTRONIC HEAT CONTROL	42558	42558
4	6-32 X 3/8 PHIL PAN M/S	39000	39000
5	WASHER #6 INTERNAL TOOTH	76188	76188
6	RELAY, 120VAC, DPST-NO	48590	48590
7	6-32 GRIP NUT ZINC PLATED	47517	47517
8	TERMINAL BLOCK, 2 POS	55620	55620
9	8-32 X 3/4 PHIL PAN MS SS	39007	39007
10	HEX NUT #8-32 STAINLESS	89129	89129
11	ACORN NUT 1/4-20	49068	49068
12	SPRING, SUSPENSION MEDIUM	42524	42524
13	SCREW 1/4-20X3/8 PN HD PH	42360	42360
14	10-24 TINNERMAM FASTENER	42221	42221

## Floss Pan and Whirlgrip Stabilizer

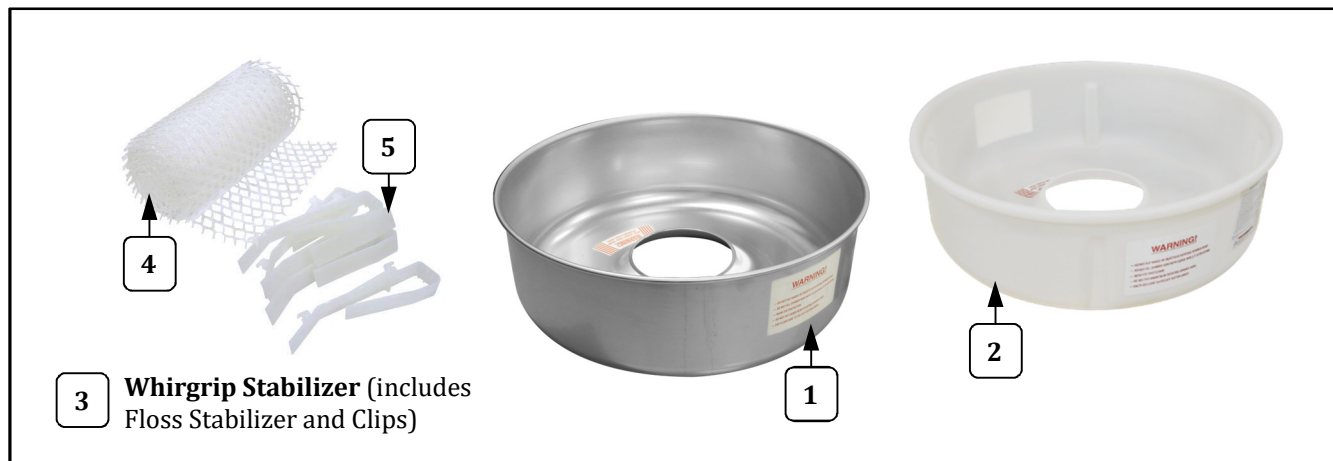

Item	Part Description	Part Number	
		3017-00-000	3024-00-000
1	FLOSS PAN (aluminum)	42040	
2	FLOSS PAN (non-metal)		42040NMR
3	WHIRLGRIP STABILIZER (Includes Floss Stabilizer and Clips)	3010	3010NM
4	FLOSS STABILIZER (Web)	43032	43032NM
5	WHIRLGRIP CLIPS	77470	77470

## Cabinet Interior - Parts List

Item	Part Description	Part Number	
		3017-00-000	3024-00-000
1	MOTOR, FLOSS MACHINE	48649	48649
2	SWITCH, LIGHTED ROCKER GR	42798	42798
3	ELECTRONIC HEAT CONTROL	42558	42558
4	6-32 X 3/8 PHIL PAN M/S	39000	39000
5	WASHER #6 INTERNAL TOOTH	76188	76188
6	RELAY, 120VAC, DPST-NO	48590	48590
7	6-32 GRIP NUT ZINC PLATED	47517	47517
8	TERMINAL BLOCK, 2 POS	55620	55620
9	8-32 X 3/4 PHIL PAN MS SS	39007	39007
10	HEX NUT #8-32 STAINLESS	89129	89129
11	ACORN NUT 1/4-20	49068	49068
12	SPRING, SUSPENSION MEDIUM	42524	42524
13	SCREW 1/4-20X3/8 PN HD PH	42360	42360
14	10-24 TINNERMAM FASTENER	42221	42221

## Floss Pan and Whirlgrip Stabilizer

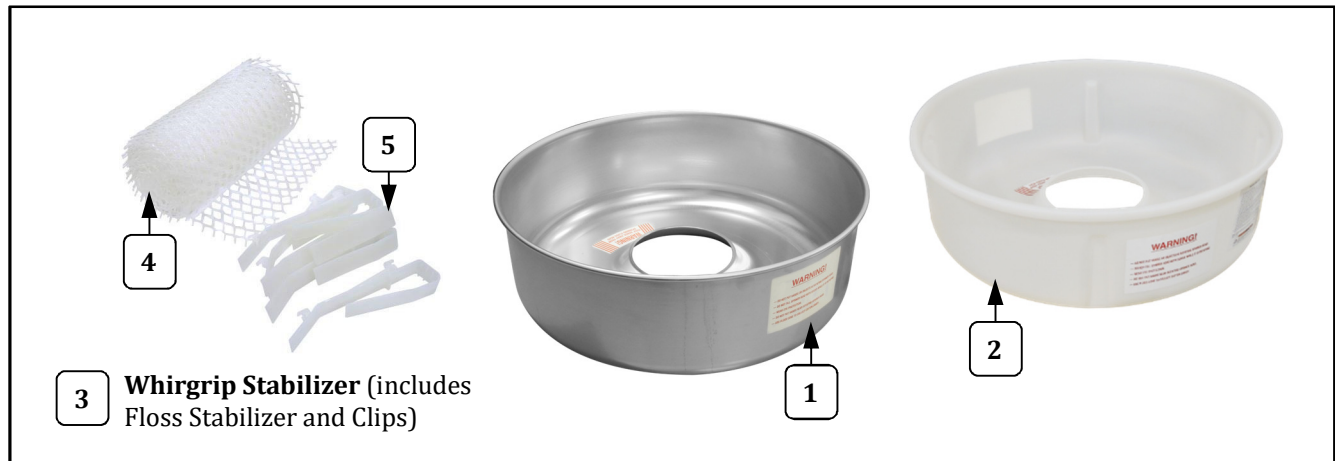

Item	Part Description	Part Number	
		3017-00-000	3024-00-000
1	FLOSS PAN (aluminum)	42040	
2	FLOSS PAN (non-metal)		42040NMR
3	WHIRLGRIP STABILIZER (Includes Floss Stabilizer and Clips)	3010	3010NM
4	FLOSS STABILIZER (Web)	43032	43032NM
5	WHIRLGRIP CLIPS	77470	77470

## Cabinet Interior - Parts List

Item	Part Description	Part Number	
		3017-00-000	3024-00-000
1	MOTOR, FLOSS MACHINE	48649	48649
2	SWITCH, LIGHTED ROCKER GR	42798	42798
3	ELECTRONIC HEAT CONTROL	42558	42558
4	6-32 X 3/8 PHIL PAN M/S	39000	39000
5	WASHER #6 INTERNAL TOOTH	76188	76188
6	RELAY, 120VAC, DPST-NO	48590	48590
7	6-32 GRIP NUT ZINC PLATED	47517	47517
8	TERMINAL BLOCK, 2 POS	55620	55620
9	8-32 X 3/4 PHIL PAN MS SS	39007	39007
10	HEX NUT #8-32 STAINLESS	89129	89129
11	ACORN NUT 1/4-20	49068	49068
12	SPRING, SUSPENSION MEDIUM	42524	42524
13	SCREW 1/4-20X3/8 PN HD PH	42360	42360
14	10-24 TINNERMAM FASTENER	42221	42221

## Floss Pan and Whirlgrip Stabilizer

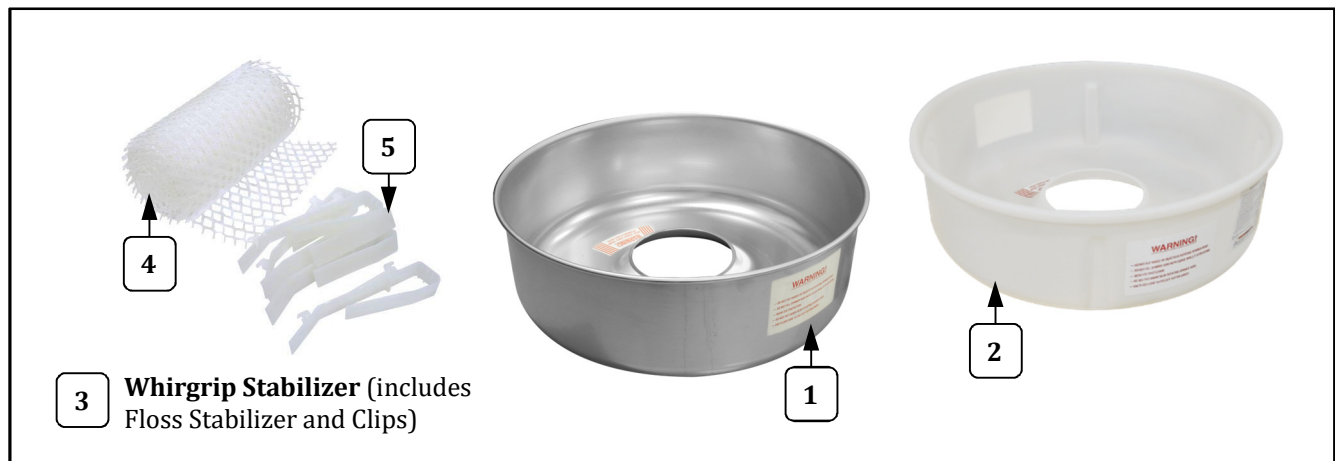

Item	Part Description	Part Number	
		3017-00-000	3024-00-000
1	FLOSS PAN (aluminum)	42040	
2	FLOSS PAN (non-metal)		42040NMR
3	WHIRLGRIP STABILIZER (Includes Floss Stabilizer and Clips)	3010	3010NM
4	FLOSS STABILIZER (Web)	43032	43032NM
5	WHIRLGRIP CLIPS	77470	77470

## Cabinet Interior - Parts List

Item	Part Description	Part Number	
		3017-00-000	3024-00-000
1	MOTOR, FLOSS MACHINE	48649	48649
2	SWITCH, LIGHTED ROCKER GR	42798	42798
3	ELECTRONIC HEAT CONTROL	42558	42558
4	6-32 X 3/8 PHIL PAN M/S	39000	39000
5	WASHER #6 INTERNAL TOOTH	76188	76188
6	RELAY, 120VAC, DPST-NO	48590	48590
7	6-32 GRIP NUT ZINC PLATED	47517	47517
8	TERMINAL BLOCK, 2 POS	55620	55620
9	8-32 X 3/4 PHIL PAN MS SS	39007	39007
10	HEX NUT #8-32 STAINLESS	89129	89129
11	ACORN NUT 1/4-20	49068	49068
12	SPRING, SUSPENSION MEDIUM	42524	42524
13	SCREW 1/4-20X3/8 PN HD PH	42360	42360
14	10-24 TINNERMAM FASTENER	42221	42221

## Floss Pan and Whirlgrip Stabilizer

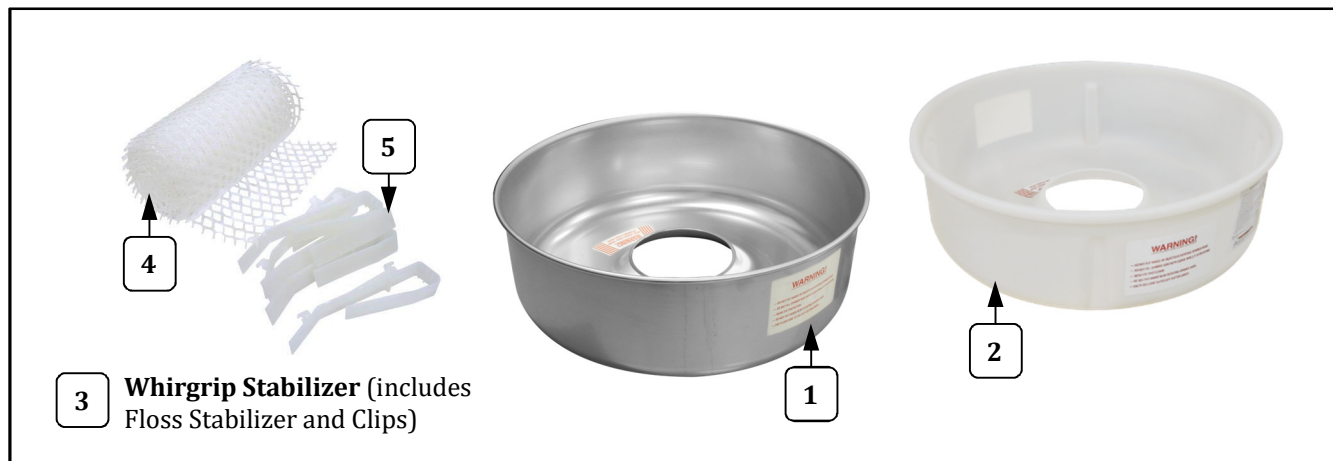

Item	Part Description	Part Number	
		3017-00-000	3024-00-000
1	FLOSS PAN (aluminum)	42040	
2	FLOSS PAN (non-metal)		42040NMR
3	WHIRLGRIP STABILIZER (Includes Floss Stabilizer and Clips)	3010	3010NM
4	FLOSS STABILIZER (Web)	43032	43032NM
5	WHIRLGRIP CLIPS	77470	77470

## Cabinet Interior - Parts List

Item	Part Description	Part Number	
		3017-00-000	3024-00-000
1	MOTOR, FLOSS MACHINE	48649	48649
2	SWITCH, LIGHTED ROCKER GR	42798	42798
3	ELECTRONIC HEAT CONTROL	42558	42558
4	6-32 X 3/8 PHIL PAN M/S	39000	39000
5	WASHER #6 INTERNAL TOOTH	76188	76188
6	RELAY, 120VAC, DPST-NO	48590	48590
7	6-32 GRIP NUT ZINC PLATED	47517	47517
8	TERMINAL BLOCK, 2 POS	55620	55620
9	8-32 X 3/4 PHIL PAN MS SS	39007	39007
10	HEX NUT #8-32 STAINLESS	89129	89129
11	ACORN NUT 1/4-20	49068	49068
12	SPRING, SUSPENSION MEDIUM	42524	42524
13	SCREW 1/4-20X3/8 PN HD PH	42360	42360
14	10-24 TINNERMAM FASTENER	42221	42221

## Floss Pan and Whirlgrip Stabilizer

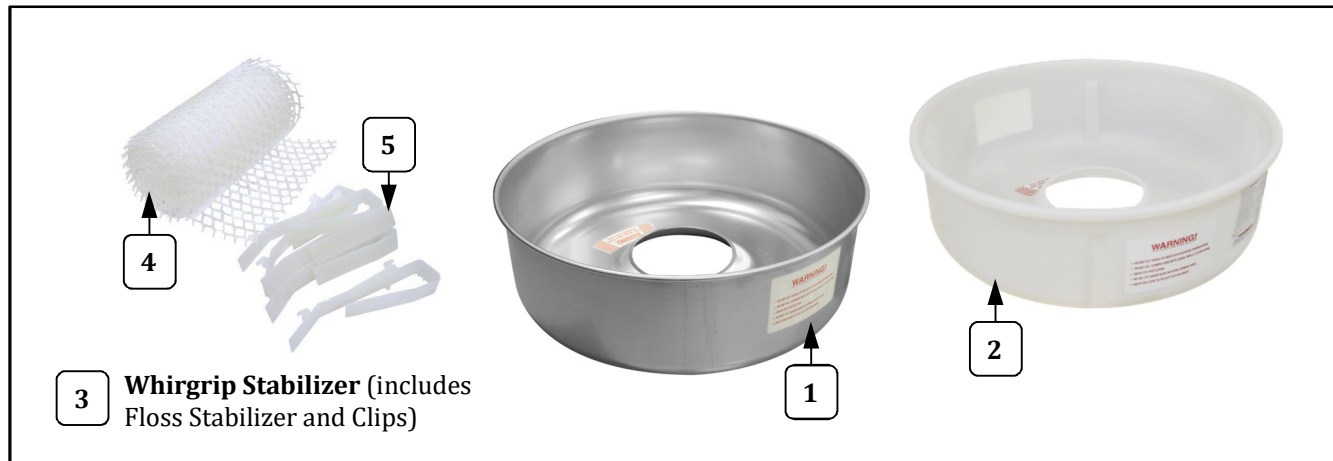

Item	Part Description	Part Number	
		3017-00-000	3024-00-000
1	FLOSS PAN (aluminum)	42040	
2	FLOSS PAN (non-metal)		42040NMR
3	WHIRLGRIP STABILIZER (Includes Floss Stabilizer and Clips)	3010	3010NM
4	FLOSS STABILIZER (Web)	43032	43032NM
5	WHIRLGRIP CLIPS	77470	77470

## Cabinet Interior - Parts List

Item	Part Description	Part Number	
		3017-00-000	3024-00-000
1	MOTOR, FLOSS MACHINE	48649	48649
2	SWITCH, LIGHTED ROCKER GR	42798	42798
3	ELECTRONIC HEAT CONTROL	42558	42558
4	6-32 X 3/8 PHIL PAN M/S	39000	39000
5	WASHER #6 INTERNAL TOOTH	76188	76188
6	RELAY, 120VAC, DPST-NO	48590	48590
7	6-32 GRIP NUT ZINC PLATED	47517	47517
8	TERMINAL BLOCK, 2 POS	55620	55620
9	8-32 X 3/4 PHIL PAN MS SS	39007	39007
10	HEX NUT #8-32 STAINLESS	89129	89129
11	ACORN NUT 1/4-20	49068	49068
12	SPRING, SUSPENSION MEDIUM	42524	42524
13	SCREW 1/4-20X3/8 PN HD PH	42360	42360
14	10-24 TINNERMAM FASTENER	42221	42221

## Floss Pan and Whirlgrip Stabilizer

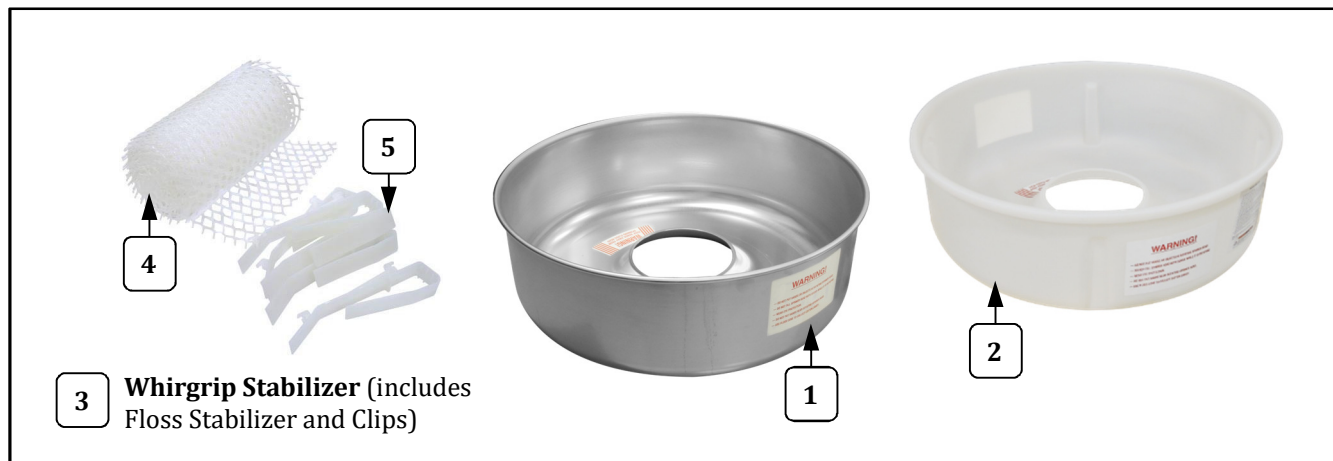

Item	Part Description	Part Number	
		3017-00-000	3024-00-000
1	FLOSS PAN (aluminum)	42040	
2	FLOSS PAN (non-metal)		42040NMR
3	WHIRLGRIP STABILIZER (Includes Floss Stabilizer and Clips)	3010	3010NM
4	FLOSS STABILIZER (Web)	43032	43032NM
5	WHIRLGRIP CLIPS	77470	77470