



Instruction Manual

Propane (LP) Small Gas Fryer

Model No. 5094 Series



GOLD MEDAL[®] PRODUCTS CO.



10700 Medallion Drive, Cincinnati, Ohio 45241-4807 USA







SAFETY PRECAUTIONS



This unit is designed for use with Propane (LP) Gas only.



	 DANGER
	<p>Gas is safe when used properly, but can be very dangerous when used improperly. We suggest that installation be carefully made by qualified personnel only. Gas companies have competent service personnel to provide safe installation.</p> <p>001_010914</p>

	 DANGER
	<p>DO NOT use a match or flame to check for gas leaks – you may cause a fire or explosion!</p> <p>003_010914</p>

	 DANGER
	<p>Never add water to hot oil. When water is added to hot oil a stream explosion may ensue spattering hot oil resulting in serious burns or more seriously hot oil in someone's eyes.</p> <p>024_010914</p>

	 DANGER
	<p>Hot oil is dangerous – severe burns can result when hot oil contacts the skin. Hot oil is flammable – keep open flames away from hot oil and its vapors. Keep a fire extinguisher near this unit. Instruct personnel on what to do if there is a grease fire. DO NOT USE WATER ON A GREASE FIRE! Use only fire extinguishers approved for grease, oil, and electric fire.</p> <p>002_102214</p>

	 DANGER
	<p>Improper installation, adjustment, alteration, service, or maintenance can cause property damage, injury, or death. Any alterations to this equipment will void the warranty and may cause a dangerous condition. This appliance is not intended to be operated by means of an external timer or separate remote-control system. NEVER make alterations to this equipment. Read the Installation, Operating, and Maintenance Instructions thoroughly before installing, servicing, or operating this equipment.</p> <p>014_020416</p>

	 WARNING
	<p>DO NOT store or use gasoline, or other flammable vapors and liquids, in the vicinity of this equipment.</p> <p>004_010914</p>



	! WARNING
	Instructions on what to do when a user smells gas can be obtained from the local gas supplier. These instructions must be posted in a prominent location where the unit is to be operated. <small>005_010914</small>

	! WARNING
	To avoid burns, DO NOT touch heated surfaces. DO NOT place or leave objects in contact with heated surfaces. <small>009_092414</small>

	! WARNING
	ALWAYS wear safety glasses when servicing this equipment. <small>010_010914</small>

	! WARNING
	No user serviceable parts inside. Refer servicing to qualified service personnel. <small>011_051514</small>

	! WARNING
	Read and understand operator's manual and all other safety instructions before using this equipment. To order copies of the operator's manual go to gmpopcorn.com or write to Gold Medal Products Co., 10700 Medallion Drive, Cincinnati, OH 45241 USA 1-(800)-543-0862 <small>022_060215</small>

	! WARNING
	DO NOT allow direct contact of this equipment by the public when used in food service locations. Only personnel trained and experienced in the equipment operation may operate this equipment. Carefully read all instructions before operation. <small>012_010914</small>

	! WARNING
	This machine is NOT to be operated by minors. <small>007_010914</small>

Note: Improvements are always being made to Gold Medal's equipment. This information may not be the latest available for your purposes. It is critical that you call Gold Medal's Technical Service Department at 1-800-543-0862 for any questions about your machine operations, replacement parts, or any service questions. (Gold Medal Products Co. does not assume any liability for injury due to careless handling and/or reckless operation of this equipment.) General images may be used in manual for reference only.



Table of Contents

SAFETY PRECAUTIONS	2
INSTALLATION INSTRUCTIONS	5
Inspection of Shipment	5
Manual	5
Model Description	5
Items Included with this Unit	5
Setup	5
Gas Installation Instructions	7
Gas Requirements	7
Gas Installation	7
Important Fire Safety Notice	8
Advanced Safety Measures	8
Checking For Gas Leaks	9
Gas Pressure	9
OPERATING INSTRUCTIONS	10
Controls and Their Functions	10
Tank Preparation	11
Filling the Tank with Oil	11
Lighting and Shutdown Instructions	12
To Light Pilot and Main Burner:	12
To Shut Down Pilot and Main Burner:	12
If the Flame Goes Out	12
Reset the High Limit	12
Operating the Fryer	13
Important Operating Information and Quality Control Tips	13
Operating the Fryer	13
Shutdown Procedure and Draining the Tank	13
Care and Cleaning	14
Troubleshooting	15
—THE FOLLOWING SECTIONS ARE FOR QUALIFIED SERVICE PERSONNEL ONLY—	16
MAINTENANCE INSTRUCTIONS	16
ORDERING SPARE PARTS	17
Cabinet and Tank View	18
5094-00-100 Gas Line, Controls, Accessories	19
5094-00-200 Gas Line, Controls, Accessories	20
Wiring Diagram	21
WARRANTY	22



INSTALLATION INSTRUCTIONS

Inspection of Shipment

After unpacking, check thoroughly for any damage which may have occurred in transit. Claims should be filed immediately with the transportation company. The warranty does not cover damage that occurs in transit, or damage caused by abuse, or consequential damage due to the operation of this machine, since it is beyond our control (reference warranty in back of manual).

Manual

Read and understand the operator's manual and all other safety instructions before using this equipment. To order copies of the operator's manual go to gmpopcorn.com or write to Gold Medal Products Co., 10700 Medallion Drive, Cincinnati, OH 45241 USA 1-(800)-543-0862.

Model Description

5094-00-100: Propane (LP) Small Gas Fryer

5094-00-200: Propane (LP) Small Gas Fryer (alternate)

Items Included with this Unit

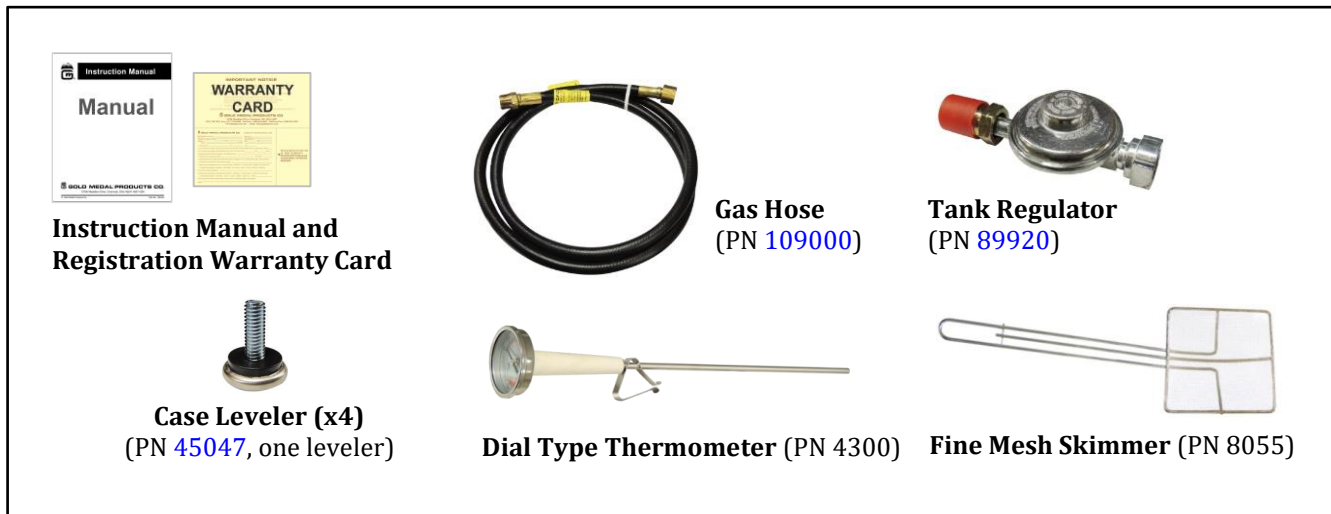

Setup

This unit is fully assembled and has been tested at the factory.

1. Remove all packaging and tape prior to operation.
2. This unit is for outdoor use only.
3. Place the fryer in a protected location on a level, sufficiently stable base or table, where it cannot be knocked off. The base or table must be strong enough to support the fryer when full of oil. Adjust the Case Levelers as needed (see image below).



4. Observe the following clearances to ensure proper air supply and maintenance:
 - Minimum of 10 inches clearance on each side of unit.
 - Minimum of 10 inches clearance on front and back of unit.
5. Bolt the unit to the counter to secure it from tipping. To restrain the fryer, use 3/8-16 bolts through the counter into tapped holes in the bottom of the fryer.
6. Set the thermometer bracket on the rim of the tank in a convenient location, where the dial thermometer can be inserted and monitored without reaching over the tank.
7. After setup, the unit should be cleaned prior to use (see Care and Cleaning section).

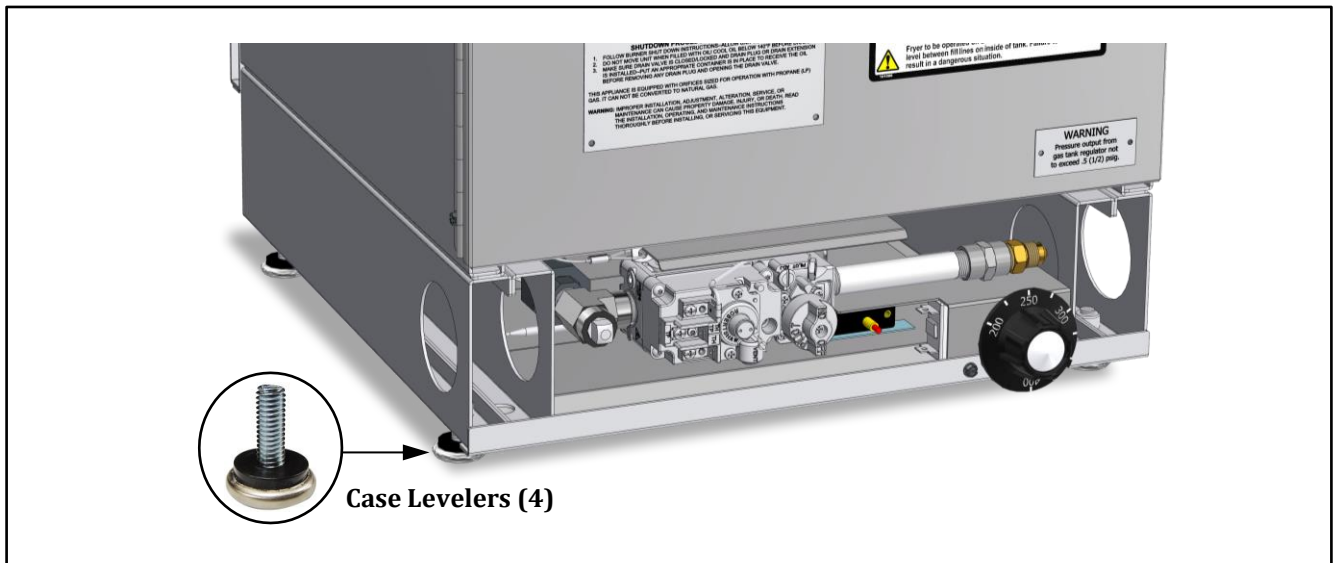



Gas Installation Instructions

Gas Requirements

The 5094 Series Fryer is designed for Propane only. Converting this unit to an alternate fuel source will void the warranty and may cause a dangerous condition.

5094-00-100, 5094-00-200: Propane Gas, 45,000 BTU/HR

NOTE: This fryer must be attached to a minimum of 40 pound LPG cylinder. For outdoor use only.

Gas Installation

	⚠ DANGER
	Gas is safe when used properly, but can be very dangerous when used improperly. We suggest that installation be carefully made by qualified personnel only. Gas companies have competent service personnel to provide safe installation. 001_010914

When installing this gas unit in the United States, you must conform with local codes, or in the absence of local codes, with National Fuel Gas Code, ANSI Z223.1 (latest edition).

NOTE: Some local codes may require ventilation hoods or automatic fire systems. During any pressure testing of the gas supply piping system at pressure equal to or less than 1/2 psig (3.45 kPa), the appliance must be isolated from the gas supply piping system by closing its individual manual shutoff valve.

After installation, all gas connections must be checked for leaks with a soap solution (see Checking for Gas Leaks section of this manual).



	⚠ CAUTION
	Be sure to observe all clearances for this unit. Refer to the Setup Section of this manual to ensure proper air supply and adequate clearance for servicing and installation of this gas unit. 033_042814



Important Fire Safety Notice

Consult your local fire protection agency for your area's requirements. Check local fire protection requirements regularly to ensure compliance with local codes and proper operation. Have a fire extinguisher near the fryer. (Use only fire extinguishers approved for grease, oil, and electrical fires.)

A thermometer (capable of 500°F or higher) should be immersed in the oil to monitor the oil temperature and make sure the unit is operating properly.

	 DANGER
	<p>Hot oil is dangerous – severe burns can result when hot oil contacts the skin. Hot oil is flammable – keep open flames away from hot oil and its vapors. Keep a fire extinguisher near the fryer. Instruct personnel on what to do if there is a grease fire. DO NOT USE WATER ON A GREASE FIRE! Use only fire extinguishers approved for grease, oil, and electric fire.</p> <p>002_020314</p>

Advanced Safety Measures

KEEP FRYER AREA CLEAN AND MAINTAINED

- Keep your floors clean and free of grease to prevent slips, accidents, and contact with a hot fryer.
- Keep filters and areas above the fryer clean. Oil-soaked lint or dust can ignite easily and flames spread quickly in an oily environment.

EDUCATE PERSONNEL

- Ensure all personnel understand the hazards of hot oil. Instruct them on proper actions to take if they suspect any part of the fryer is malfunctioning.

If your fryer malfunctions, have it serviced by Qualified Service Personnel.

IMPORTANT: If the fryer starts to smoke or boil abnormally, **shut off gas supply** and determine the reason why the fryer is overheating before attempting to use it.



- Ensure all personnel understand procedures to follow if the High Limit Control is tripped. (See High Limit Control description in the Controls and Their Functions section of this manual.)
- Educate all personnel on proper procedures to follow if a grease fire should occur. **DO NOT USE WATER ON A GREASE FIRE!** Never direct the extinguisher in a manner that would blow grease out of the tank.

Ensure a fire extinguisher is readily available to extinguish a grease, oil, and electric fire. Make sure all personnel are properly trained in the use of the fire extinguisher.



Checking For Gas Leaks

After making any gas connection, or after performing any work on the gas train, **ALWAYS** check ALL gas connections for leaks with a soap solution.

	 DANGER
	DO NOT use a match or flame to check for gas leaks – you may cause a fire or explosion! When gas connections are complete, if applicable, have a qualified professional wire the unit to a power source which will carry the current specified on the unit's data plate. 034_121322

1. Apply **SOAP BUBBLES** to all connections and pressurize the gas line to check for leaks. Perform this test outdoors away from any flames or sparks.
DO NOT use a flame to check for gas leaks.
2. It is recommended to check your flexible gas lines and gas fittings for wear and tear on a frequent basis. Stop using the appliance immediately if damage is found, and contact a qualified professional to inspect and correct any issue.
3. Securely route all gas lines away from flames and high temperature areas.
4. Contact Gold Medal Technical Support, or a qualified Gas Service Technician with any questions.

Gas Pressure

We have determined that optimum frying occurs when the gas pressure is adequate. For propane gas, we recommend a manifold pressure setting of 10 inches of water column at inlet (7–8 inches at outlet). The pressure is measured at the appliance when the main burner is ignited.

Lighting and Shutdown Instructions

For pilot and burner lighting and shutdown instructions, refer to the Operating Instruction section of this manual.



OPERATING INSTRUCTIONS

Controls and Their Functions

COMBINATION VALVE (Safety Valve)

The Combination Valve has three settings to control gas flow, PILOT, ON, and OFF.
(Reference the Lighting and Shutdown Instructions in the Operating Instruction section.)

PILOT: When valve is in PILOT position, **depress valve** to provide gas to light the pilot.

ON: After pilot is lit, turn valve to ON position to allow operation of the Heat Control.

OFF: Rotate valve to OFF position to extinguish the pilot and burner.

HEAT CONTROL (Thermostat)

The Heat Control sets the temperature of the cooking oil. The Heat Control thermostat has the following settings:

OFF: Heat Control is OFF, shuts off the gas supply to the main burner—burner will not light with thermostat OFF.

Temperature Range from 200°F to 400°F: When temperature is set, the Heat Control allows the gas supply to reach the main burner. Use an independent thermometer (capable of 500°F or higher) to monitor the oil temperature during use.

HIGH LIMIT RESET SWITCH

The High Limit Control shuts off the unit if temperature exceeds 450°F. The High Limit Control can only be reset after the fryer has cooled to normal operating temperatures.
(Reference the Lighting and Shutdown Instructions in the Operating Instruction section.)

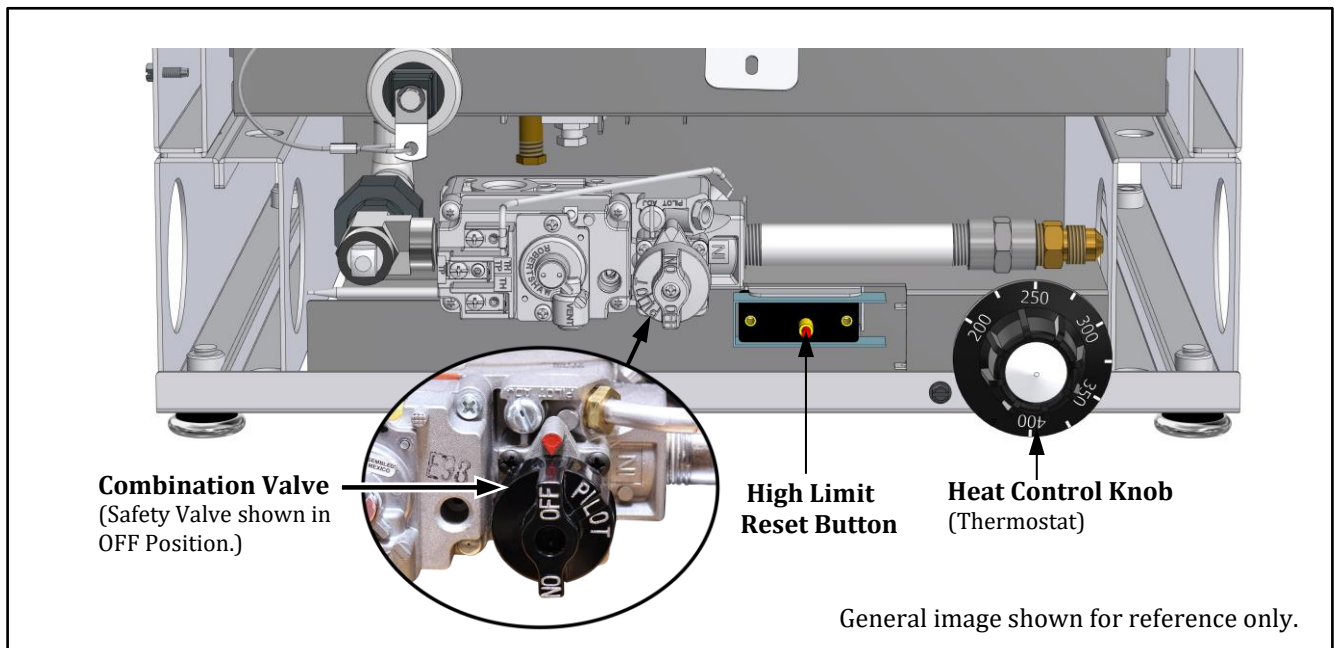



DRAIN VALVE (with Drain Plug)

Drain Valve allows cooking oil to be drained from the tank—the valve handle has a safety collar, and the drain line has a drain plug to help prevent unintentional tank draining.

Always allow hot cooking oil to cool below 140°F before removing the drain plug/draining the unit, see image.

Important Note: Make sure drain valve is closed before removing drain plug.

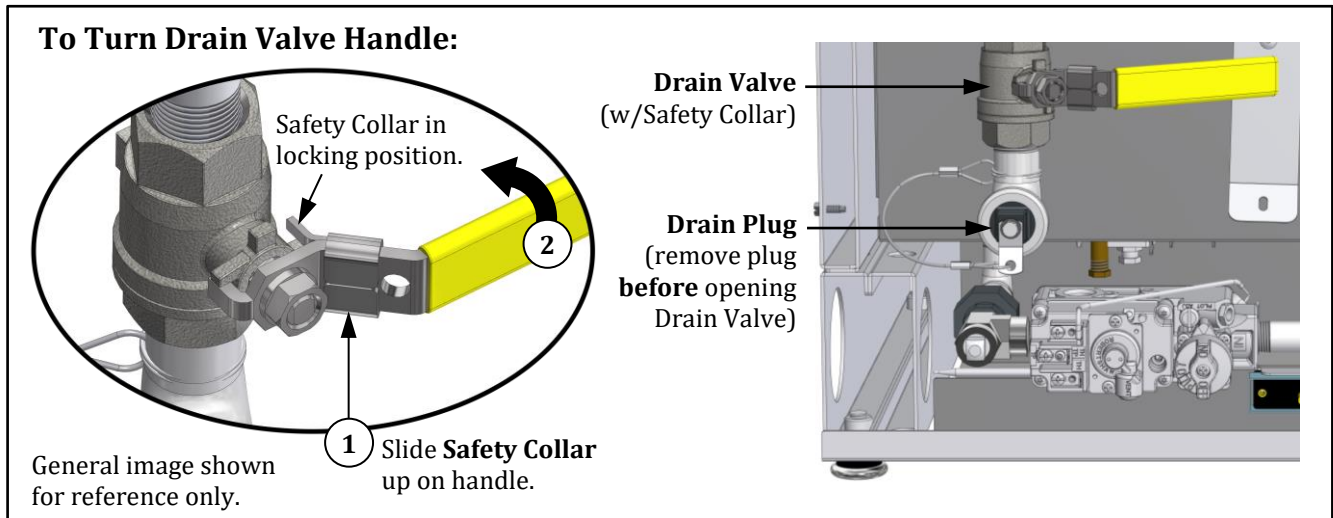

Tank Preparation

Before operating for the first time, the unit should be cleaned and thoroughly dried before adding oil. See the Cleaning and Care section of this manual for cleaning instructions.

Prior to each use, **make sure the drain valve is completely closed** and the safety collar and pin lock hold the valve handle in place.

Filling the Tank with Oil

Tank Capacity: The tank will hold approximately 30 lbs. of cooking oil.

Initially fill the tank to the minimum oil fill line. **DO NOT** operate this unit with the cooking oil below the minimum oil level.

IMPORTANT: Cooking oil expands upon heating. To safely bring the oil level up to the maximum fill level, carefully add additional increments of oil as it heats until it reaches the maximum fill line. **DO NOT** overfill the tank, as overfilling could result in a dangerous situation.

Hot oil is dangerous - be sure you have thoroughly read the Safety Precautions of this manual.

DO NOT allow water to contact oil. Only cook product intended for this appliance. Do not attempt to cook products with high water content or with surface moisture present. Do not operate in the rain or near any source of water. Failure to keep water away from oil may result in explosion and severe burns. Make sure appliance is completely dry after cleaning, including inside any drain valves.

Lighting and Shutdown Instructions

	⚠ CAUTION
	If pilot is turned off or goes out, shut off the gas supply and turn all unit controls off—a minimum 5-minute shutdown period is required before attempting to re-light.

035_120622

To Light Pilot and Main Burner:

Unit must be in position and ready for use before lighting (see Operating the Fryer section). Do not light unit when tank is empty.

1. Open access panel for pilot, see image.
2. Turn Combination Valve to PILOT position.
3. Depress valve and light pilot with a long handle lighter or match.
4. **Continue to depress valve** for 30-45 seconds or until pilot remains burning steadily, then release valve.
5. Close access panel.
6. Turn Combination Valve to ON position.
7. Set Thermostat Dial (Heat Control) to temperature needed. Main burner will light.

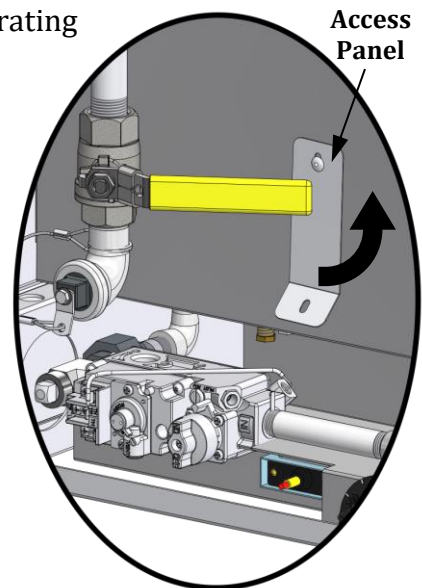

To Shut Down Pilot and Main Burner:

1. Turn Thermostat OFF.
2. Turn Combination Valve OFF—press valve in to pass PILOT position.
3. Shut off gas supply.

Before attempting to re-light unit, a **minimum 5-minute shutdown period is required.**

If the Flame Goes Out

If the flame goes out, shut off the gas supply and turn all unit controls off—a **minimum 5-minute shutdown period is required before attempting to re-light.**

1. Check to see if you are out of gas.
2. Check to see if the thermopile is in the proper position (in the pilot flame).

Reset the High Limit

If burner is extinguished because of high-limit tripping, shut off the gas supply, turn Thermostat and Combination Valve OFF—allow unit to cool down to a normal operating temperature before re-lighting (reference Troubleshooting section).



Operating the Fryer

Important Operating Information and Quality Control Tips

- Don't overheat. Don't fry if the oil temperature exceeds 400°F.
- Don't waste money, use only high quality heavy duty frying shortening.
- Don't fry food in broken-down frying shortening; broken down oil is thinned, darkened.
- Don't overload the frying tank.
- Don't fill the basket more than half full.
- Don't shake breaded items over fryer.
- Don't salt items over fryer.
- Don't introduce water to fryer.
- Don't thaw frozen foods before frying.

Operating the Fryer

1. **Make sure the drain valve is completely closed** and the safety collar holds the valve handle in place; make sure the drain plug is installed.
2. Fill tank to minimum oil level with cooking oil, then turn main burner ON (reference the Lighting and Shutdown Instructions).
3. Set thermostat dial to desired cooking temperature. As oil heats and expands, carefully add increments of cooking oil until it reaches the maximum fill line. **DO NOT overfill the tank, as overfilling could result in a dangerous situation.**
4. When oil reaches the set temperature, fryer is ready for use. Use an independent thermometer (capable of 500°F or higher) to monitor the oil temperature during use.
5. To help maintain oil quality, periodically skim off excess batter (food) particles.

Shutdown Procedure and Draining the Tank

1. When frying is complete, turn pilot and main burner OFF (reference Lighting and Shutdown Instructions).
2. Remove any forms and thermometer—allow unit to cool completely.
3. **DO NOT move this unit when filled with oil!** Allow hot cooking oil to cool below 140°F before attempting to drain the unit.
4. Put an appropriate container in place to receive the oil.
5. With drain valve CLOSED/LOCKED, remove the drain plug, see image.
6. Slide the safety collar up on the drain valve handle and OPEN the drain valve to empty the cooking oil from the tank.
7. For unit cleaning instructions, see Care and Cleaning section.

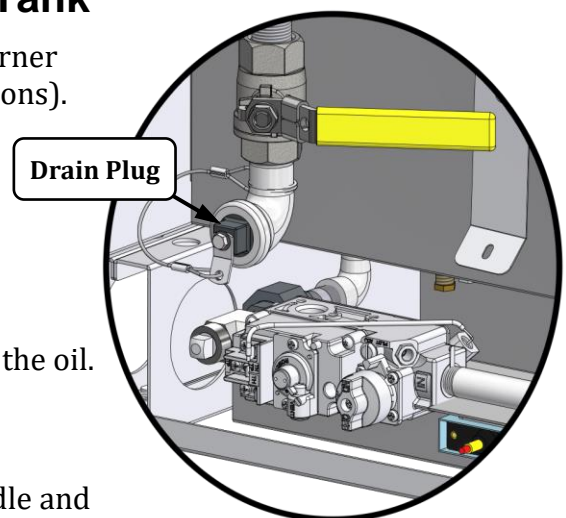



Care and Cleaning

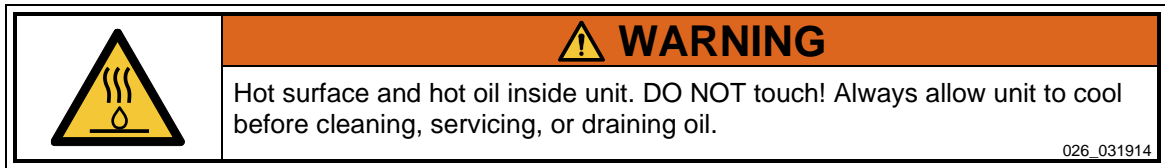

Good sanitation practice demands that all food preparation equipment be cleaned regularly (only use non-toxic, food grade cleaners).

For surfaces needing further cleaning or degreasing, Watchdog Stainless Cleaner (Item No. 2088) or Watchdog Concession Equipment Degreaser (Item No. 2580) is available for use accordingly. For any cleaning products used, follow the manufacturer's instructions on the product. **DO NOT use oven cleaners or abrasive materials** as they will damage parts of machine.

Follow the directions below to clean the unit each day after use.

1. Follow the Shutdown Procedure and Draining the Tank instructions before attempting to clean the unit.

DO NOT move this unit when filled with oil! Allow hot cooking oil to cool below 140°F before attempting drain the unit.

2. Remove all pans/accessories and take them to the sink to clean with soap and water, then rinse and dry.
3. Make sure the drain valve is completely closed and the safety collar holds the valve handle in place; make sure the drain plug is installed—then fill the tank with water to the MINIMUM oil level. **DO NOT FILL above the minimum oil level or equipment damage may occur.**
4. Add appropriate amount of dish soap.

To deep clean a tank which has a build-up of cooking oil: Instead of soap, add appropriate amount of Gold Medal's Heat'n Kleen (Item No. 2095) per amount of water used (see Heat'n Kleen product instructions).

5. Bring solution to a boil (**DO NOT heat above 250°F**), then turn unit OFF, and allow solution to cool below 100°F. **DO NOT move this unit when filled with solution!**
6. Once cooled, drain the unit into an appropriate container and remove all solution.
7. Clean outside of unit with a soft cloth, dampened with soap and hot water (then wipe again to remove any remaining cleaner).
8. Thoroughly dry the unit after cleaning, including inside any drain valves.





Troubleshooting



Issue	Possible Cause	Solution
Gas Issues		A. For gas issues refer to the initial Gas Installation Instructions.
Cooking Issues	A. Product cooking issues	A. Reference the Important Operating Information and Quality Control Tips located in the Operating the Fryer section of this manual.
High Limit Control Tripping (powers down machine)	<p>A. Oil level too low</p> <p>B. Heat Control issue/Oil too hot</p>	<p>A. Check that the oil level has not fallen below the minimum oil level. DO NOT operate this unit with the oil below the minimum oil level (see Filling the Tank with Oil section).</p> <p>B. Insert an independent thermometer (capable of 500°F or higher) in the tank of oil to check the oil temperature. The High Limit Control will trip above 450°F. Allow oil to cool down to normal operating temperatures, then reference the burner Lighting and Shutdown Instructions in the Operating Instruction section of this manual.) If the High Limit is reset and trips again, contact a qualified service person for inspection/repair.</p>







—THE FOLLOWING SECTIONS ARE FOR QUALIFIED SERVICE PERSONNEL ONLY—

MAINTENANCE INSTRUCTIONS

	 DANGER
	<p>Improper installation, adjustment, alteration, service, or maintenance can cause property damage, injury, or death. Any alterations to this equipment will void the warranty and may cause a dangerous condition. This appliance is not intended to be operated by means of an external timer or separate remote-control system. NEVER make alterations to this equipment. Read the Installation, Operating, and Maintenance Instructions thoroughly before installing, servicing, or operating this equipment.</p> <p>014_020416</p>

	 WARNING
	<p>Hot surface and hot oil inside unit. DO NOT touch! Always allow unit to cool before cleaning, servicing, or draining oil.</p> <p>026_031914</p>

	 WARNING
	<p>No user serviceable parts inside. Refer servicing to qualified service personnel.</p> <p>011_051514</p>

	 CAUTION
	<p>THE FOLLOWING SECTIONS OF THIS MANUAL ARE INTENDED ONLY FOR QUALIFIED SERVICE PERSONNEL WHO ARE FAMILIAR WITH GAS EQUIPMENT. THESE ARE NOT INTENDED FOR THE OPERATOR.</p> <p>027b_051514</p>



ORDERING SPARE PARTS

1. Identify the needed part by checking it against the photos, illustrations, and/or parts list. (General images may be used in manual for reference only.)
2. Use only approved replacement parts when servicing this unit.
3. When ordering, please include part number, part name, and quantity needed.
4. Please include your model number, serial number, and date of manufacture (located on the machine nameplate/data plate) with your order.
5. Address all parts orders to Parts Department, Gold Medal Products Co., 10700 Medallion Drive, Cincinnati, Ohio 45241-4807

or place orders by phone or online:

Phone: (800) 543-0862
(513) 769-7676

Fax: (800) 542-1496
(513) 769-8500

E-mail: info@gmpopcorn.com
Web Page: gmpopcorn.com

Cabinet and Tank View

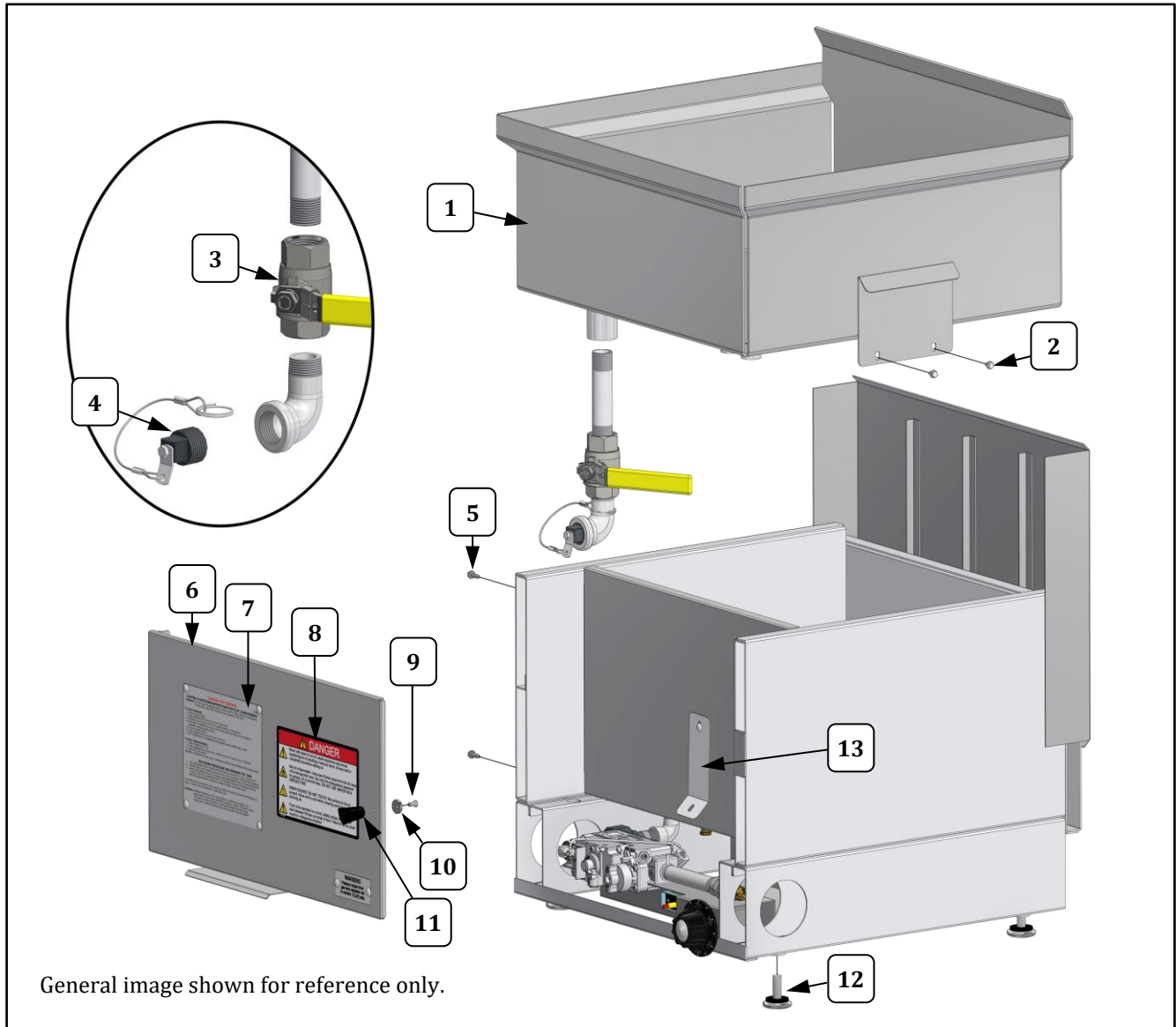

Item	Part Description	Part Number
		All Models
1	OIL TANK WELD ASSY	89950
2	8-32 X 1/4 HX HD WHIZLOCK	42045
3	3/4 NPT BALL VALVE	89014
4	DRAIN PLUG ASSEMBLY	89440
5	8-32 X 1/2 SLOTTED H W H	49379
6	DOOR WELD ASSEMBLY	89915
7	INSTRUCTION PLATE	105062

Item	Part Description	Part Number
		All Models
8	FRYER TANK SAFETY LABEL	101096
9	8-32X3/8 FL HD PH MS	20065
10	MAGNET USES 8 FLT HD SC	50013
11	KNOB 8-32	47120
12	LEVELERS CASE (sold individually)	45047
13	PILOT ACCESS COVER	42381



5094-00-100 Gas Line, Controls, Accessories

***Pilot Installation Note:**
Use the pilot fitting for (LP) propane marked 4211.

Accessories

Reference wire diagram when wiring unit.

18 Aluminum Tubing (not shown)

Item	Part Description	Part Number 5099-00-100
1*	PILOT BURNER ASSY	57033
2	THERMOPILE	88845
3	1/4-20 X 3/8 BUTTON HEAD	12492
4	PILOT BURNER BRACKET	89703
5	10-32 X 1/2 TRUSS HEAD	12189
6	BURNER	89960
7	ELEMENT MOUNT STIFFENER	89911
8	1/4-20 X 3/4 GRADE 5 BOLT	74520
9	3/8NPT UNION	89759
10	3/8 NPT PIPE PLUG	89770
11	COMBINATION CONTROL	88843
12	ADAPTER,GAS LINE 3/8 NPT	74595

Item	Part Description	Part Number 5099-00-100
13	8-32 X 1/4 HX HD WHIZLOCK	42045
14	SPACER,#10 ID	47264
15	HI LIMIT CONTROL	89615
16	AR Gas Thermostat (Heat Control)	100907
17	KNOB, REPLACEMENT	89700
18	1/4 OD ALUM TUBING (sold/ft.)	63475
19	TANK REGULATOR	89920
20	GAS HOSE (has a Flared Hose Fitting)	109000
21	FINE MESH SKIMMER	8055
21	DIAL TYPE THERMOMETER	4300



5094-00-200 Gas Line, Controls, Accessories

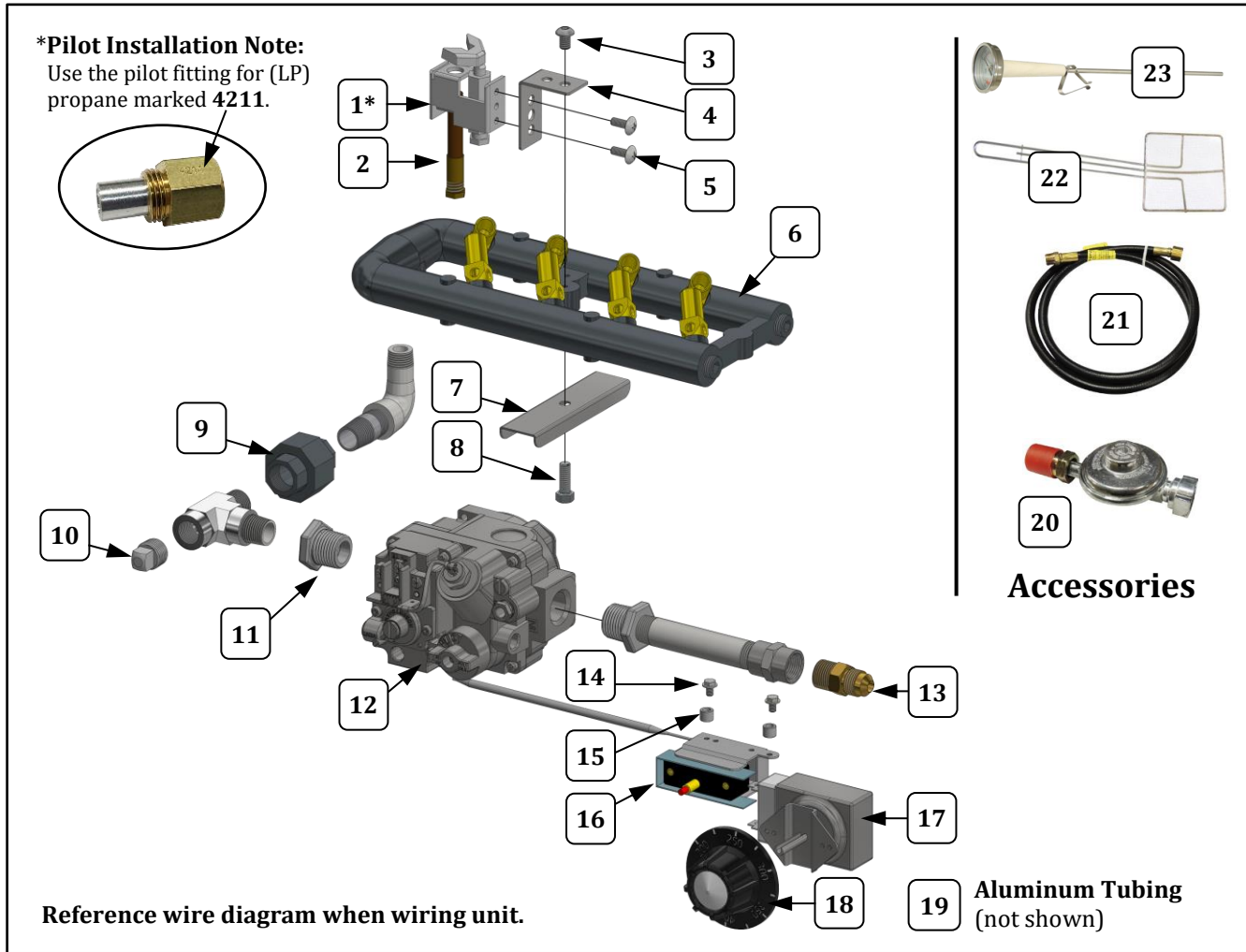

Item	Part Description	Part Number 5099-00-200
1*	PILOT BURNER ASSY	57033
2	THERMOPILE	88845
3	1/4-20 X 3/8 BUTTON HEAD	12492
4	PILOT BURNER BRACKET	89703
5	10-32 X 1/2 TRUSS HEAD	12189
6	BURNER	89960
7	ELEMENT MOUNT STIFFENER	89911
8	1/4-20 X 3/4 GRADE 5 BOLT	74520
9	3/8NPT UNION	89759
10	3/8 NPT PIPE PLUG	89770
11	1/2 x 3/8FNPT Reducer	100903
12	AB007-MV Gas Valve	100905

Item	Part Description	Part Number 5099-00-200
13	ADAPTER,GAS LINE 3/8 NPT	74595
14	8-32 X 1/4 HX HD WHIZLOCK	42045
15	SPACER,#10 ID	47264
16	HI LIMIT CONTROL	89615
17	AR Gas Thermostat (Heat Control)	100907
18	KNOB, REPLACEMENT	89700
19	1/4 OD ALUM TUBING (sold/ft.)	63475
20	TANK REGULATOR	89920
21	GAS HOSE (has a Flared Hose Fitting)	109000
22	FINE MESH SKIMMER	8055
23	DIAL TYPE THERMOMETER	4300



Wiring Diagram

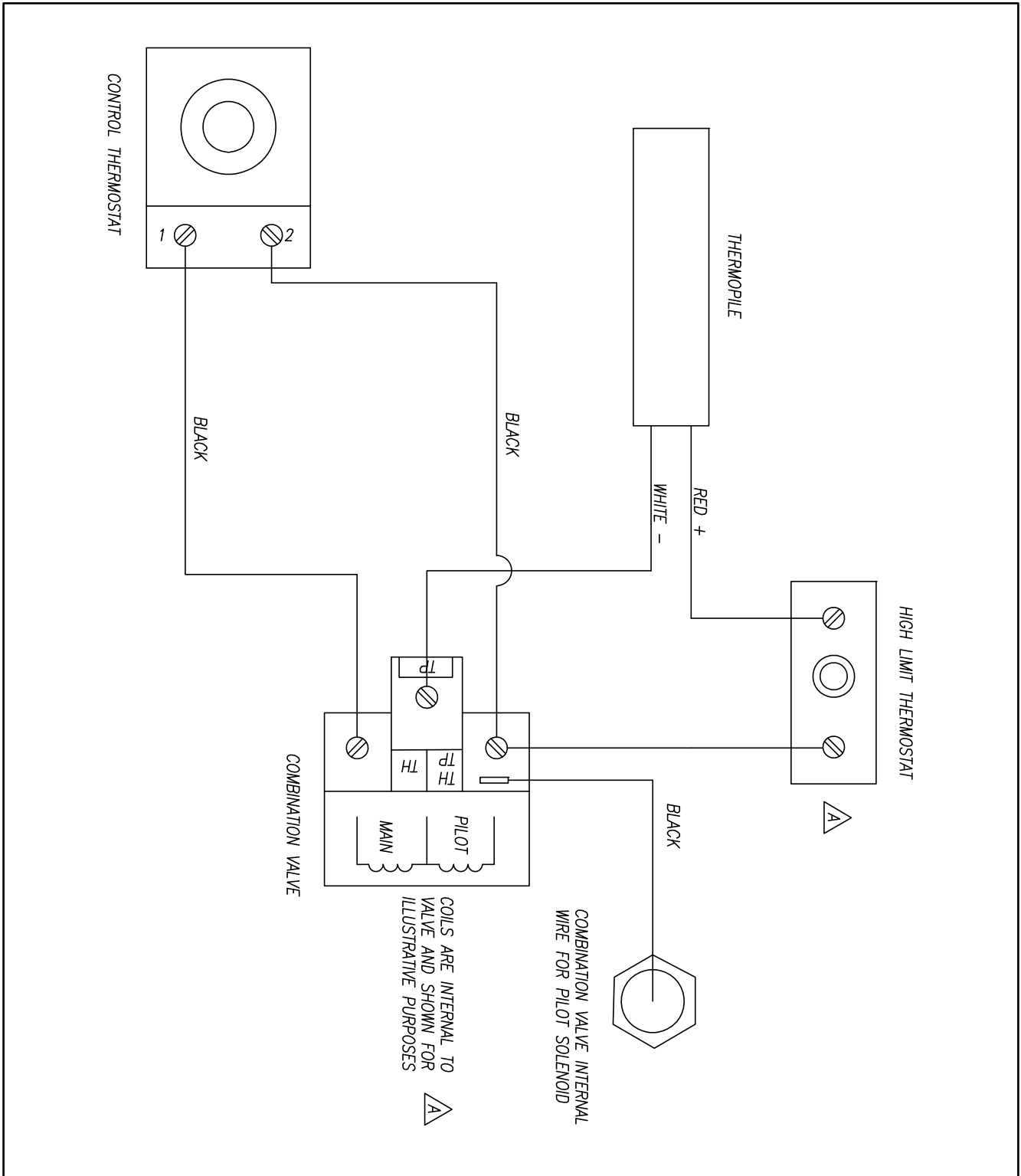



WARRANTY

Gold Medal Products Co. warrants to the original purchaser each item of its manufacture to be free of defects in workmanship and material under normal use and service. Gold Medal Products Co.'s obligation under this warranty is limited solely to repairing or replacing parts, f.o.b. Cincinnati, Ohio, which in its judgment are defective in workmanship or material and which are returned, freight prepaid, to its Cincinnati, Ohio factory or other designated point. Except for "Perishable Parts" on specific machines, the above warranty applies for a period of two (2) years from the date of original sale to the original purchaser of equipment when recommended operating instructions and maintenance procedures have been followed. These are packed with the machine. Parts warranty is two (2) years, labor is six (6) months.

THIS WARRANTY IS IN LIEU OF ALL OTHER WARRANTIES EXPRESSED OR IMPLIED, AND OF ALL OTHER OBLIGATIONS OR LIABILITIES ON OUR PART, INCLUDING THE IMPLIED WARRANTY OF MERCHANTABILITY. THERE ARE NO WARRANTIES WHICH EXTEND BEYOND THE DESCRIPTION ON THE FACE HEREOF. In no event shall Gold Medal Products Co. be liable for special, incidental or consequential damages. No claim under this warranty will be honored if the equipment covered has been misused, neglected, damaged in transit, or has been tampered with or changed in any way. No claim under this warranty shall be honored in the event that components in the unit at the time of the claim were not supplied or approved by Gold Medal Products Co. This warranty is effective only when electrical items have been properly attached to city utility lines only at proper voltages. This warranty is not transferable without the written consent of Gold Medal Products Co.

The term "Original Purchaser" as used in this warranty shall be deemed to mean that person, firm, association, or corporation who was billed by the GOLD MEDAL PRODUCTS CO., or their authorized distributor for the equipment.

THIS WARRANTY HAS NO EFFECT AND IS VOID UNLESS THE ORIGINAL PURCHASER FIRST CALLS GOLD MEDAL PRODUCTS CO. AT 1-800-543-0862 TO DISCUSS WITH OUR SERVICE REPRESENTATIVE THE EQUIPMENT PROBLEM, AND, IF NECESSARY, FOR INSTRUCTIONS CONCERNING THE REPAIR OR REPLACEMENT OF PARTS.

NOTE: This equipment is manufactured and sold for commercial use only.



GOLD MEDAL PRODUCTS CO.

10700 Medallion Drive, Cincinnati, Ohio 45241-4807 USA

gmpopcorn.com

Phone: (800) 543-0862 Fax: (800) 542-1496
(513) 769-7676 (513) 769-8500