



# Instruction Manual

## Nacho Cheese Dispenser

Model No. 5300



**GOLD MEDAL<sup>®</sup> PRODUCTS CO.**

10700 Medallion Drive, Cincinnati, Ohio 45241-4807 USA



# Table of Contents

**SAFETY PRECAUTIONS ..... 3**

**INSTALLATION INSTRUCTIONS ..... 5**

    Inspection of Shipment ..... 5

    Manual ..... 5

    Model Description ..... 5

    Items Included with this Unit ..... 5

    Setup ..... 5

    Electrical Requirements ..... 6

    Before You Plug In Machine ..... 6

**Decal Installation ..... 7**

**OPERATING INSTRUCTIONS ..... 9**

    Controls and Their Functions ..... 9

    Operating Instructions ..... 9

**Product Installation and Removal ..... 10**

        Basket Liner Installation ..... 10

**Care and Cleaning ..... 12**

**Troubleshooting ..... 13**

**—THE FOLLOWING SECTIONS ARE FOR QUALIFIED SERVICE PERSONNEL ONLY— ..... 14**

**MAINTENANCE INSTRUCTIONS ..... 14**

**Master Control Board Settings ..... 15**

**ORDERING SPARE PARTS ..... 16**

    Cabinet Front and Interior View ..... 17



    Cabinet Back and Interior View ..... 18



**Wiring Diagram ..... 19**



**WARRANTY ..... 20**





# SAFETY PRECAUTIONS

|   |   |
|---|---|
|  |  <b>DANGER</b>   |
|   | <p>Machine must be properly grounded to prevent electrical shock to personnel. Failure to do so could result in serious injury, or death. Make sure all machine switches are in the OFF position before plugging the equipment into the receptacle. Keep cord and plug off the ground and away from moisture. Always unplug the equipment before cleaning or servicing. DO NOT immerse any part of this equipment in water. DO NOT use a water jet or excessive water when cleaning.</p> <p style="text-align: right; font-size: small;">008_012221</p> |

|   |   |
|---|---|
|  |  <b>DANGER</b>   |
|   | <p>Improper installation, adjustment, alteration, service, or maintenance can cause property damage, injury, or death. Any alterations to this equipment will void the warranty and may cause a dangerous condition. This appliance is not intended to be operated by means of an external timer or separate remote-control system. NEVER make alterations to this equipment. Read the Installation, Operating, and Maintenance Instructions thoroughly before installing, servicing, or operating this equipment.</p> <p style="text-align: right; font-size: small;">014_020416</p> |



|   |  |
|---|--|
|  |  <b>WARNING</b>  |
|   | <p>To avoid burns, DO NOT touch heated surfaces. DO NOT place or leave objects in contact with heated surfaces.</p> <p style="text-align: right; font-size: small;">009_092414</p> |

|   |   |
|---|---|
|  |  <b>WARNING</b>                              |
|   | <p>ALWAYS wear safety glasses when servicing this equipment.</p> <p style="text-align: right; font-size: small;">010_010914</p> |

|   |   |
|---|---|
|  |  <b>WARNING</b>  |
|   | <p>No user serviceable parts inside. Refer servicing to qualified service personnel.</p> <p style="text-align: right; font-size: small;">011_051514</p> |

|   |  |
|---|--|
|  |  <b>WARNING</b>   |
|   | <p>Read and understand operator's manual and all other safety instructions before using this equipment. To order copies of the operator's manual go to <a href="http://gmpopcorn.com">gmpopcorn.com</a> or write to Gold Medal Products Co., 10700 Medallion Drive, Cincinnati, OH 45241 USA 1-(800)-543-0862</p> <p style="text-align: right; font-size: small;">022_060215</p> |



|   |   |
|---|---|
|  |  <b>WARNING</b>  |
|   | DO NOT allow direct contact of this equipment by the public when used in food service locations. Only personnel trained and experienced in the equipment operation may operate this equipment. Carefully read all instructions before operation.<br><span style="float: right;">012_010914</span> |

|   |  |
|---|--|
|  |  <b>WARNING</b> |
|   | This machine is NOT to be operated by minors.<br><span style="float: right;">007_010914</span>   |

|   |  |
|---|--|
|  |  <b>CAUTION</b>   |
|   | If the supply cord is damaged, it must be replaced by Gold Medal Products Co., its service agent or similarly qualified persons in order to avoid a hazard.<br><span style="float: right;">039_080614</span> |

**Note:** Improvements are always being made to Gold Medal's equipment. This information may not be the latest available for your purposes. It is critical that you call Gold Medal's Technical Service Department at 1-800-543-0862 for any questions about your machine operations, replacement parts, or any service questions. (Gold Medal Products Co. does not assume any liability for injury due to careless handling and/or reckless operation of this equipment.) General images may be used in manual for reference only.



---

# INSTALLATION INSTRUCTIONS

## Inspection of Shipment

After unpacking, check thoroughly for any damage which may have occurred in transit. Claims should be filed immediately with the transportation company. The warranty does not cover damage that occurs in transit, or damage caused by abuse, or consequential damage due to the operation of this machine, since it is beyond our control (reference warranty in back of manual).

## Manual

Read and understand the operator's manual and all other safety instructions before using this equipment. To order copies of the operator's manual go to [gmpopcorn.com](http://gmpopcorn.com) or write to Gold Medal Products Co., 10700 Medallion Drive, Cincinnati, OH 45241 USA 1-(800)-543-0862.

## Model Description

**5300:** Nacho Cheese Dispenser with three dispense buttons for small, large, and manual dispense settings.

## Items Included with this Unit

- Manual and Warranty Registration Card
- Unit Decals (if applicable)
- Basket Liner (PN 100557) (reference Product Installation section for use)



## Setup

1. Remove all packaging and tape prior to operation.
2. Place unit on a sturdy, level base for use.
3. If decals need to be installed, reference the Decal Installation section.
4. After setup, the unit should be cleaned prior to use (see Care and Cleaning section).

## Electrical Requirements

The following power supply must be provided (reference unit Data Plate for Wattage requirement):



120 V~, 60 Hz

|   |  |
|---|--|
|  |  <b>DANGER</b>  |
|   | <p>Machine must be properly grounded to prevent electrical shock to personnel. Failure to do so could result in serious injury, or death.</p> <p>Make sure all machine switches are in the OFF position before plugging the equipment into the receptacle. Keep cord and plug off the ground and away from moisture. Always unplug the equipment before cleaning or servicing.</p> <p>DO NOT immerse any part of this equipment in water.</p> <p>DO NOT use a water jet or excessive water when cleaning.</p> <p style="text-align: right;">008_012221</p> |

A certified electrician must furnish sufficient power for proper machine operation and install any supplied receptacle (reference unit Data Plate for model specific Volts AC, Hertz, and Wattage requirements). We recommend this equipment be on a dedicated and protected circuit. Failure to wire properly will void the warranty and may result in damage to the machine. It is Gold Medal Products Co.'s recommendation that this machine be plugged directly into a wall outlet. The use of extension cords is not recommended due to safety concerns, and may cause sacrificed and/or reduced performance. Make sure cord is located to prevent a trip hazard or unit upset. Units with an IEC Power Cord - make sure the IEC cord is properly seated into the IEC receptacle before powering up the machine.

## Before You Plug In Machine

1. Make sure all machine switches are OFF before plugging equipment into receptacle.
2. Make sure wall outlet can accept the grounded plugs (where applicable) on the power supply cord.
3. The wall outlet must have the proper polarity. If in doubt, have a competent electrician inspect the outlet and correct if necessary.
4. **DO NOT** use a grounded to un-grounded receptacle adapter (where applicable).
5. Install unit in a level position.

|   |   |
|---|---|
|  |  <b>CAUTION</b>  |
|   | <p>If the supply cord is damaged, it must be replaced by Gold Medal Products Co., its service agent or similarly qualified persons in order to avoid a hazard.</p> <p style="text-align: right;">039_080614</p> |



# Decal Installation

## Decal Installation Instructions

Follow the instructions below to install decals packed separately for a Nacho Cheese Dispenser (if applicable). Unit must be off, unplugged, and allowed to cool before attempting installation. General images are shown for reference purposes only (decals may vary by unit).

### Items Needed for Installation:

- Set of Decals - for door, right and left panels, rear panel, and bottom panel (if applicable).
- Gold Medal Watchdog Glass Cleaner (Item No. 2588) or a **non-ammonia** type glass cleaner.
- Plastic squeegee, medium size applicator (type used for Bondo® filler).

### Decal Location



### Decal Installation

For best results, **check decal alignment often** during installation.

**Step 1:** Hold decal up to mounting surface to determine decal placement.

**Step 2:** Apply glass cleaner to “wet” the surface where decal is to be placed (Figure A). **Do not wipe the glass cleaner off.**

**Apply Glass Cleaner**  
(DO NOT wipe off)

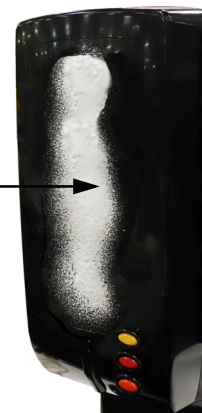

**Figure A**



**Step 3:** Peel paper backing down from top few inches of decal (Figure B). **Do not remove the entire paper backing all at once.**

Align decal at the top, then place on unit.



**Step 4:** Use a plastic squeegee to press top of decal to unit. Rub squeegee back and forth across the decal to work any trapped air bubbles and excess spray toward the outer edges (Figure C). This helps the decal cling to the unit.

Use a plastic squeegee to install decal.



**CHECK ALIGNMENT OFTEN** – if decal must be repositioned, carefully peel a **small portion** upwards, then adjust as needed.

**If the decal has set for several minutes and does not slide easily,** attempting to remove it may damage the decal.

**Step 5:** To continue, hold top of decal in place, then peel down more paper backing and repeat the procedure until the entire decal is installed. Wipe off excess glass cleaner.

**Step 6:** Repeat installation steps for remaining decals. To install left and right decals, the unit should be placed on its side, and braced against a wall, or held to prevent tipping.

**Units with an IEC Plug:** The Rear Panel Decal must be “cut to fit” above the plug (Figure D).

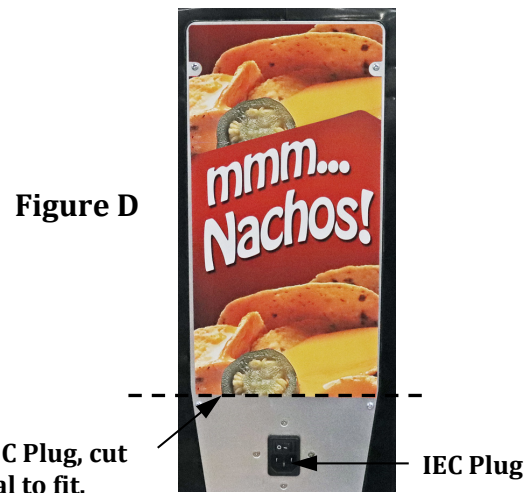

# OPERATING INSTRUCTIONS

## Controls and Their Functions

**POWER SWITCH** – Turns the unit ON/OFF.

**THERMOMETER** – Displays the air temperature inside the cabinet. The unit is factory set to a default temperature level for warming the product—temperature setting is not adjustable.

**DISPENSER BUTTONS** – The unit has three dispense volume buttons (large, small, and manual). To change the large or small dispense volume settings, have qualified service personnel reference the Master Board Settings, in the Maintenance section.

**Yellow Button** – LARGE portion (factory set to dispense for 8 seconds).

**Red Button** – SMALL portion (factory set to dispense for 4 seconds).

**Orange Button** – MANUAL (free-flow), press button to dispense product.

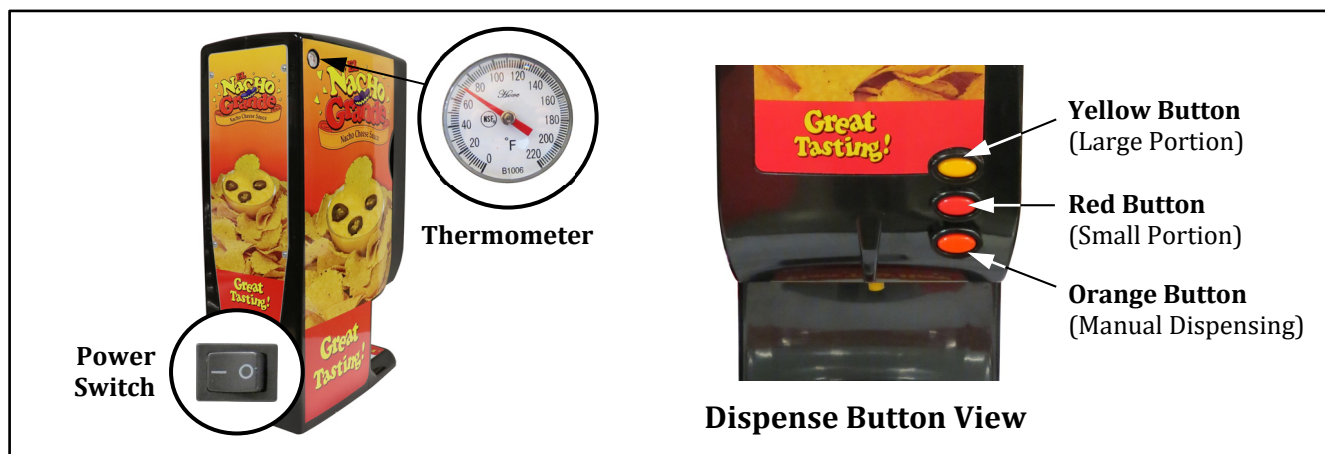

## Operating Instructions

1. Turn Power Switch ON.
2. Pre-heat unit with unopened product inside—product starting from room temperature 70–75°F (21–24°C) takes approximately 4 hours to reach 140°F (60°C).

**Important:** The temperature of the unit is factory set between 140–155°F (60–68°C) (the interior air temperature)—unit temperature setting is not adjustable.

**The actual product temperature may be lower or higher than the set temperature depending on how long it has been heated.**

For specific product safe food holding temperature, reference your local code and/or instructions from food product manufacturer.

3. Install preheated product (reference Product Installation section), then place a tray in position to receive cheese, and press dispense button for desired amount of product.



# Product Installation and Removal

The dispenser is equipped with a Bag Support Tray to hold the bag of cheese in use, and an upper Cheese Bag Tray to hold a bag of cheese for pre-warming.

Add a Basket Liner (PN 100557) to each Bag Support Tray opening to provide cushion/support for a product bag with the small cap. Follow instructions below to install the liner and insert product.

## Basket Liner Installation

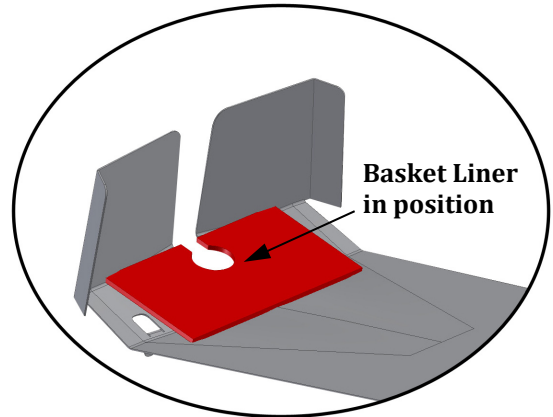
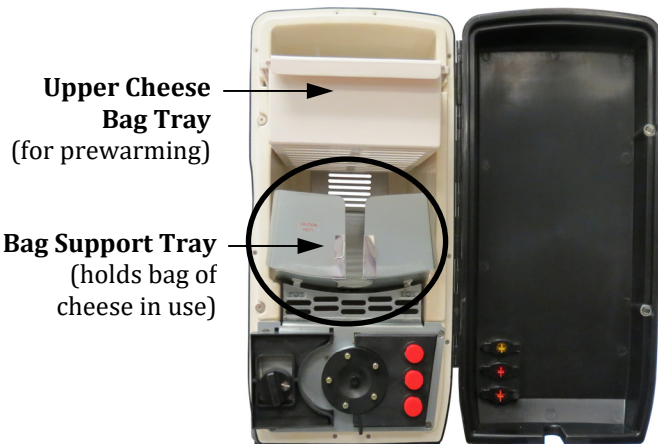

Inside view of Bag Support Tray

**Step 1.** Open the cabinet door and locate the Bag Support Tray. **Caution:** Tray may be hot when adding or changing the product.

**Step 2.** Position the Basket Liner in bag support opening as shown.

## Product Installation

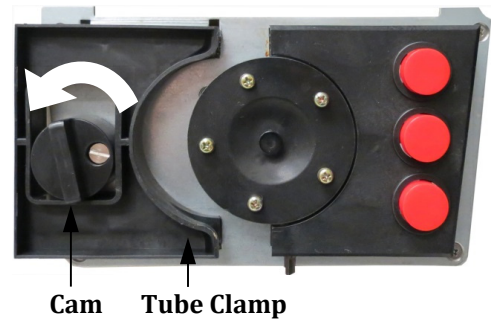
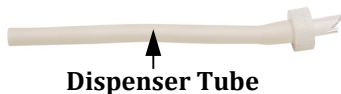

**Step 1:** Pull ring to remove fitting cover from a preheated product bag. Use a new dispenser tube (PN 5285) for each bag.

**Step 2:** The dispenser tube will pierce the inner seal of the bag when installed. Make sure the cap is securely threaded onto the bag fitting. **Caution:** Product may be hot.

**Step 3:** Open the front door of the dispenser. Open the tube clamp by turning the cam counterclockwise.



**Step 4:** Remove the Upper Cheese Bag Tray. Place the product in support tray with spout and tube directed toward the front, and downward through the tray opening.

**Basket Liner must be in position** (for product bag with a small cap).

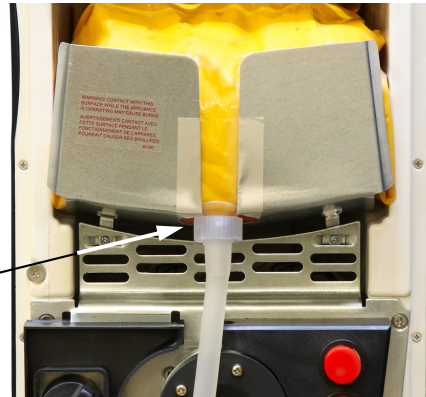

**Step 5:** Guide the tube through the pump slot from top to bottom.

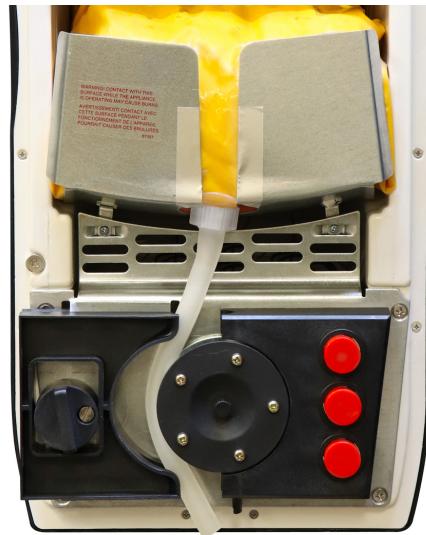

**Step 6:** Close the tube clamp by turning the cam clockwise. Place the upper bag tray back in the unit and close the dispenser door.

**Product Removal:**

1. Open the front door of the unit.
2. Open Tube Clamp (see Step 3 of Product Installation).
3. Remove tubing, by pulling from the bottom up.
4. Remove product bag and tube from the cheese dispenser. Reuse the basket liner for the next bag of cheese.

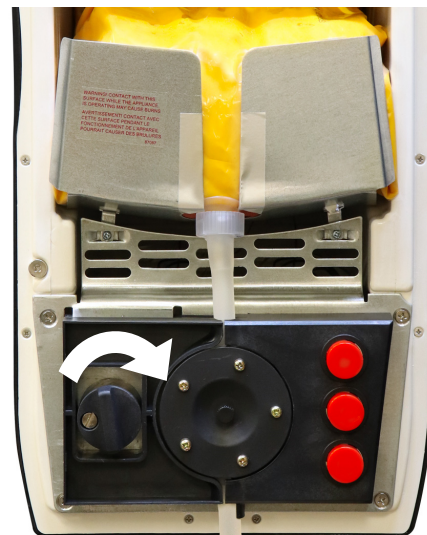



## Care and Cleaning

|   |  |
|---|--|
|  | <b>⚠ DANGER</b>  |
|   | Machine must be properly grounded to prevent electrical shock to personnel. <b>DO NOT immerse in water.</b> DO NOT clean appliance with a water jet or steam cleaner. Always unplug the equipment before cleaning or servicing. 025_051321 |

|   |   |
|---|---|
|  | <b>⚠ WARNING</b>  |
|   | To avoid burns, DO NOT touch heated surfaces. DO NOT place or leave objects in contact with heated surfaces. 009_092414 |

Good sanitation practice demands that all food preparation equipment be cleaned regularly (only use non-toxic, food grade cleaners).

For any cleaning products used, follow the manufacturer's instructions on the product. **DO NOT use oven cleaners or abrasive materials** as they will damage parts of the machine.

### Cleaning Guidelines

1. Turn Power Switch OFF, unplug the unit, and allow it to cool before cleaning the unit.
2. Remove cheese bag and tube.
3. Clean tray (slide tray out to remove it for cleaning).
4. Wipe interior and exterior surfaces of unit with a clean, slightly damp cloth. NEVER USE ABRASIVES on this unit.  
**Note:** Periodically, use a vacuum cleaner and/or a damp cloth to clean the air intake as needed.
5. Remove the pump head assembly (by removing the thumb screw) and wipe clean; reattach the pump head assembly.
6. Reinsert the clean, dry tray for use.





## Troubleshooting



| <b>Issue</b>                             | <b>Possible Cause</b>  | <b>Solution</b>  |
|--|--|--|
| <b>Unit Not Working</b>                  | A. Power to Unit   | A. Make sure the unit is securely plugged into the wall outlet. Units with an IEC power cord, make sure cord is securely plugged into unit.<br><br>Check the outlet for power.<br><br>Check the circuit breaker for the wall outlet. |
| <b>Door Will Not Close</b>               | A. Clamp Open<br>B. Tray Not Fully Inserted                              | A. Close clamp.<br>B. Install tray correctly.  |
| <b>Product Does Not Dispense</b>         | A. Product Empty   | A. Replace empty bag.  |
| <b>Product is Leaking</b>                | A. Clamp Not Fully Closed<br>B. Tube Loose from Spout                    | A. Close clamp.<br>B. Check tube; be sure it is securely seated into bag (reference Product Installation section).   |
| <b>Tube Not Reaching Bottom of Clamp</b> | A. Spout not seated correctly in Bag Support Tray                        | A. Seat the bag spout in the Bag Support Tray correctly (reference Product Installation section).  |
| <b>Product is Cold</b>                   | A. Dispenser door left open; also see Power to Unit                      | A. Keep door closed.   |
| <b>Excess Product Remains in Bag</b>     | A. Bag spout not seated correctly in Bag Support Tray<br>B. Folds in Bag | A. Seat the bag spout in the Bag Support Tray correctly (reference Product Installation section).<br>B. Lay bag flat in tray.  |





—THE FOLLOWING SECTIONS ARE FOR QUALIFIED SERVICE PERSONNEL ONLY—

# MAINTENANCE INSTRUCTIONS

|   |   |
|---|---|
|  |  <b>DANGER</b>   |
|   | <p>Machine must be properly grounded to prevent electrical shock to personnel. Failure to do so could result in serious injury, or death. Make sure all machine switches are in the OFF position before plugging the equipment into the receptacle. Keep cord and plug off the ground and away from moisture. Always unplug the equipment before cleaning or servicing. DO NOT immerse any part of this equipment in water. DO NOT use a water jet or excessive water when cleaning.</p> <p style="text-align: right; font-size: small;">008_012221</p> |

|   |   |
|---|---|
|  |  <b>DANGER</b>   |
|   | <p>Improper installation, adjustment, alteration, service, or maintenance can cause property damage, injury, or death. Any alterations to this equipment will void the warranty and may cause a dangerous condition. This appliance is not intended to be operated by means of an external timer or separate remote-control system. NEVER make alterations to this equipment. Read the Installation, Operating, and Maintenance Instructions thoroughly before installing, servicing, or operating this equipment.</p> <p style="text-align: right; font-size: small;">014_020416</p> |

|   |   |
|---|---|
|  |  <b>WARNING</b>  |
|   | <p>No user serviceable parts inside. Refer servicing to qualified service personnel.</p> <p style="text-align: right; font-size: small;">011_051514</p> |

|   |  |
|---|--|
|  |  <b>CAUTION</b>   |
|   | <p>THE FOLLOWING SECTIONS OF THIS MANUAL ARE INTENDED ONLY FOR QUALIFIED SERVICE PERSONNEL WHO ARE FAMILIAR WITH ELECTRICAL EQUIPMENT. THESE ARE NOT INTENDED FOR THE OPERATOR.</p> <p style="text-align: right; font-size: small;">027_010914</p> |



# Master Control Board Settings

Dispense time settings must be changed by qualified service personnel only. The dispense time for large and small portions (Yellow and Red Buttons) is adjustable. Orange Button is manual operation only (no time setting).

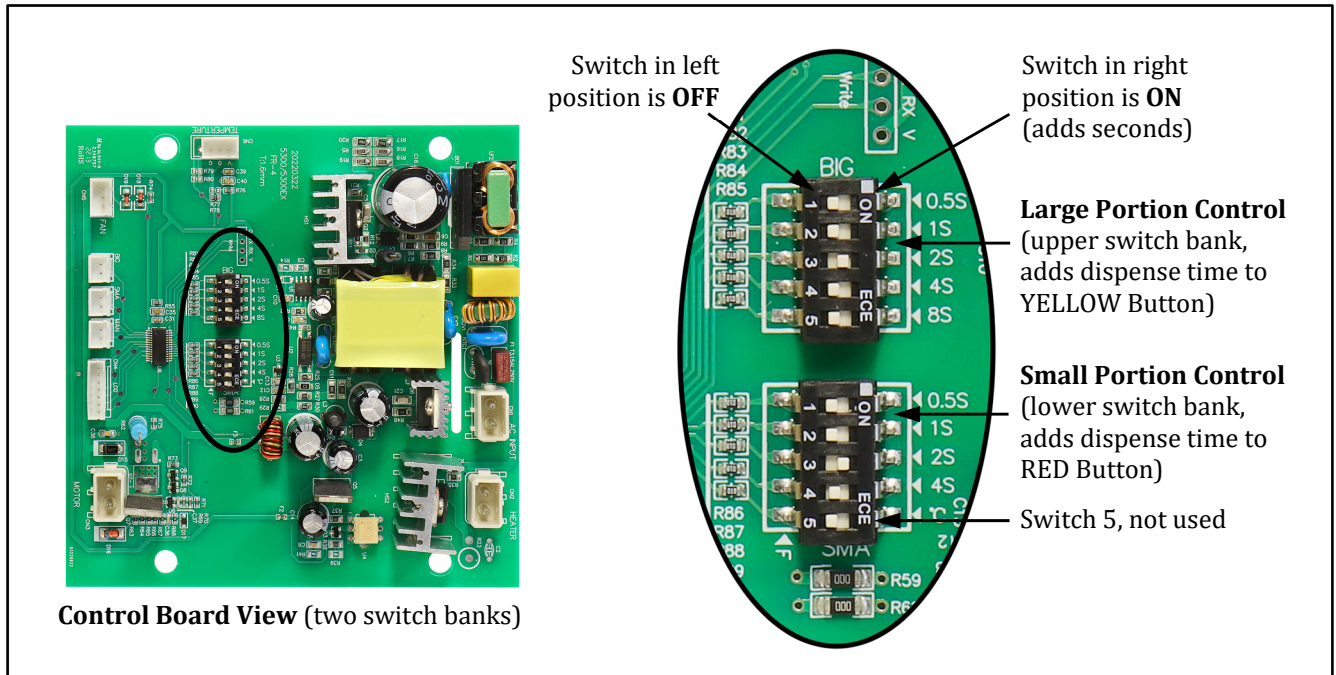

Control Board View (two switch banks)

## To change a Dispense Time Setting:

1. Determine serving size desired:
  - a. Press **Orange Button** to manually dispense a small serving into a container.
  - b. Note the dispense time (in seconds); repeat steps for a large serving.
2. Turn Power Switch OFF, unplug unit, and allow it to cool.
3. Remove the rear access panel; locate the control board (see image above).
4. Locate the switch bank for the button's portion control.
5. Turn ON a switch (or multiple switches) to add the seconds indicated to the button's dispense time (see table below), turn OFF any unneeded switches in the bank.

| Switch Number   | Dispense Time |
|-----------------|---------------|
| 1               | ½ second      |
| 2               | 1 second      |
| 3               | 2 seconds     |
| 4               | 4 seconds     |
| 5 (Yellow Only) | 8 seconds     |

### Example:

Turn ON switch 2 (1 second) and switch 4 (4 seconds) to add a total of 5 seconds to the button's dispense time.

6. Replace the rear panel before operation (DO NOT over tighten the screws).



---

## ORDERING SPARE PARTS

1. Identify the needed part by checking it against the photos, illustrations, and/or parts list. (General images may be used in manual for reference only.)
2. Use only approved replacement parts when servicing this unit.
3. When ordering, please include part number, part name, and quantity needed.
4. Please include your model number, serial number, and date of manufacture (located on the machine nameplate/data plate) with your order.
5. Address all parts orders to Parts Department, Gold Medal Products Co., 10700 Medallion Drive, Cincinnati, Ohio 45241-4807

or place orders by phone or online:

Phone: (800) 543-0862  
(513) 769-7676

Fax: (800) 542-1496  
(513) 769-8500

E-mail: [info@gmpopcorn.com](mailto:info@gmpopcorn.com)  
Web Page: [gmpopcorn.com](http://gmpopcorn.com)



## Cabinet Front and Interior View

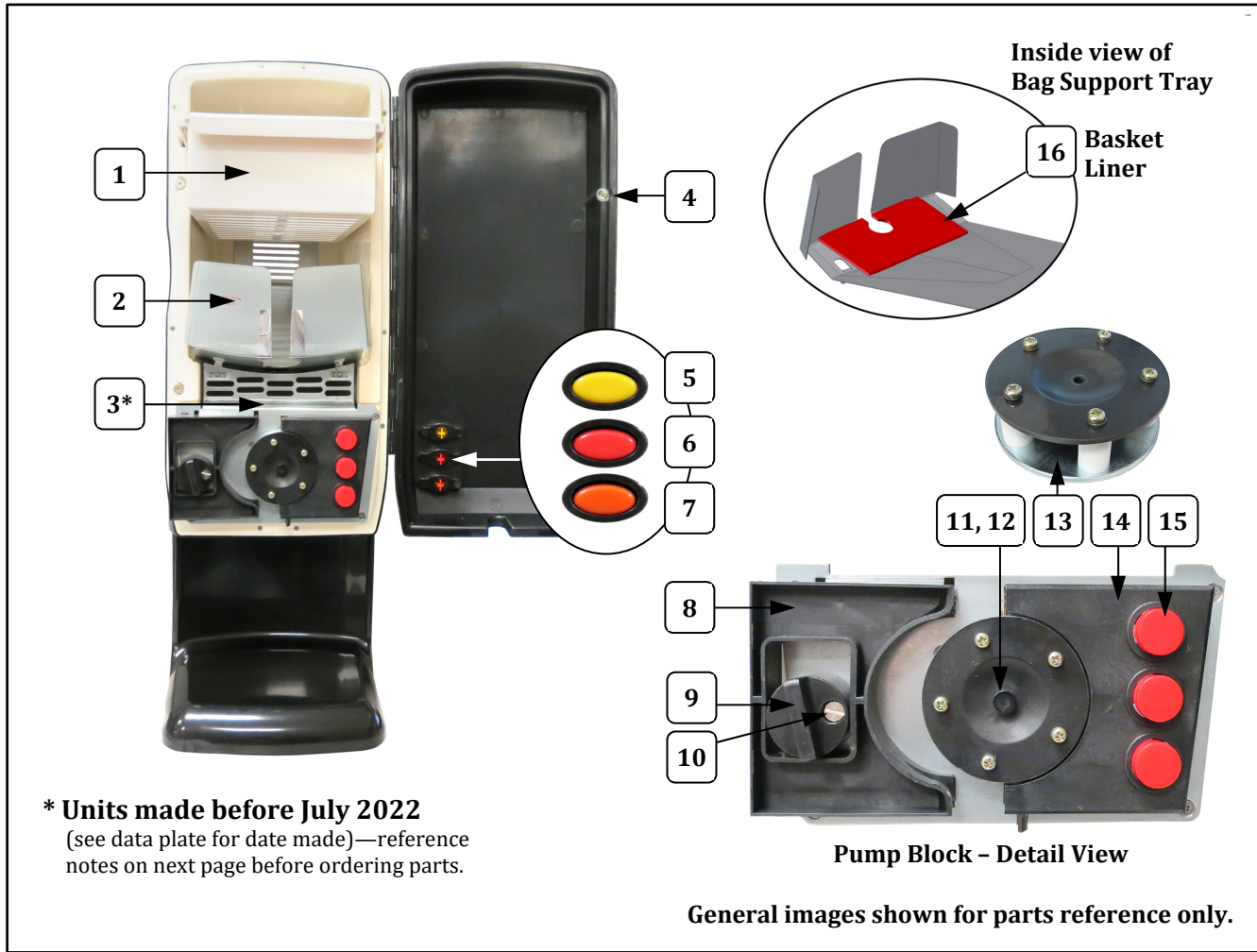

| Item | Part Description   | Part Number            |
|------|--|------------------------|
|      |  | 5300                   |
| 1    | CHEESE BAG TRAY  | <a href="#">EN0008</a> |
| 2    | CHEESE BAG SUPPORT (Bag Support Tray)  | <a href="#">36027</a>  |
| 3*   | BRACKET, MTR (DISPENSER) (units made before July 2022 see information above) | 118128                 |
| 4    | DOOR MAGNET  | <a href="#">36042</a>  |
| 5    | YELLOW BUTTON  | 36033YL                |
| 6    | RED BUTTON   | 36033RD                |
| 7    | ORANGE BUTTON  | 36033OR                |
| 8    | SLIDING PUMP BLOCK   | <a href="#">36031</a>  |
| 9    | PUMP CAM LOCK  | <a href="#">36032</a>  |
| 10   | CAM M5 SLOTTED SCREW   | <a href="#">77125</a>  |
| 11   | PUMP MOUNT THUMB SCREW   | <a href="#">77122</a>  |
| 12   | M3-WASHER-SPRING   | <a href="#">77130</a>  |
| 13   | PUMP HEAD ASSY 5 ROLLER  | <a href="#">36105</a>  |
| 14   | PUMP BLOCK RIGHT-SWITCH  | <a href="#">36030</a>  |
| 15   | SWITCH   | <a href="#">36038</a>  |
| 16   | BASKET LINER   | 100557                 |



## Cabinet Back and Interior View

General images shown for parts reference only.

**\* Units made before July 2022** (see data plate for date made)—to maintain compatibility, use the following parts *if original parts are not available*:

- To replace an old-style Control Board (PN 36048), order a new-style Control Board (PN 118126).
- To replace an old-style Motor (PN 36043) with a new-style motor—you need the following 3 parts to maintain compatibility: A new-style Motor (PN 118025), Motor Bracket (PN 118128), Control (PN 118126).

Reference Gold Medal Service Bulletin 0167 for more details.

**\*\*CAUTION:** If supply cord is damaged, it must be replaced by Gold Medal Products Co., its service agent, or similarly qualified persons in order to avoid a hazard.

| Item | Part Description  | Part Number |
|------|---|-------------|
|      |   | 5300        |
| 1    | 24 V FAN BLOWER   | 36046       |
| 2    | HEATER ASSEMBLY   | 36047       |
| 3*   | BOARD, CHEESE DISPENSER (units made before July 2022 see information above) | 118126      |
| 4*   | MOTOR, 24VDC (units made before July 2022 see information above)            | 118025      |

| Item | Part Description          | Part Number |
|------|---------------------------|-------------|
|      |                           | 5300        |
| 5    | PCBA TEMPERATURE SENSOR   | 36049       |
| 6    | REAR ACCESS PANEL         | 36026       |
| 7    | SPST SWITCH               | 36119       |
| 8**  | POWER CORD W/PCBA CONNECT | 23038       |
| 9    | STRAIN RELIEF             | 87810       |
| 10   | THERMOMETER               | EN0001      |



# Wiring Diagram

## Model No. 5300

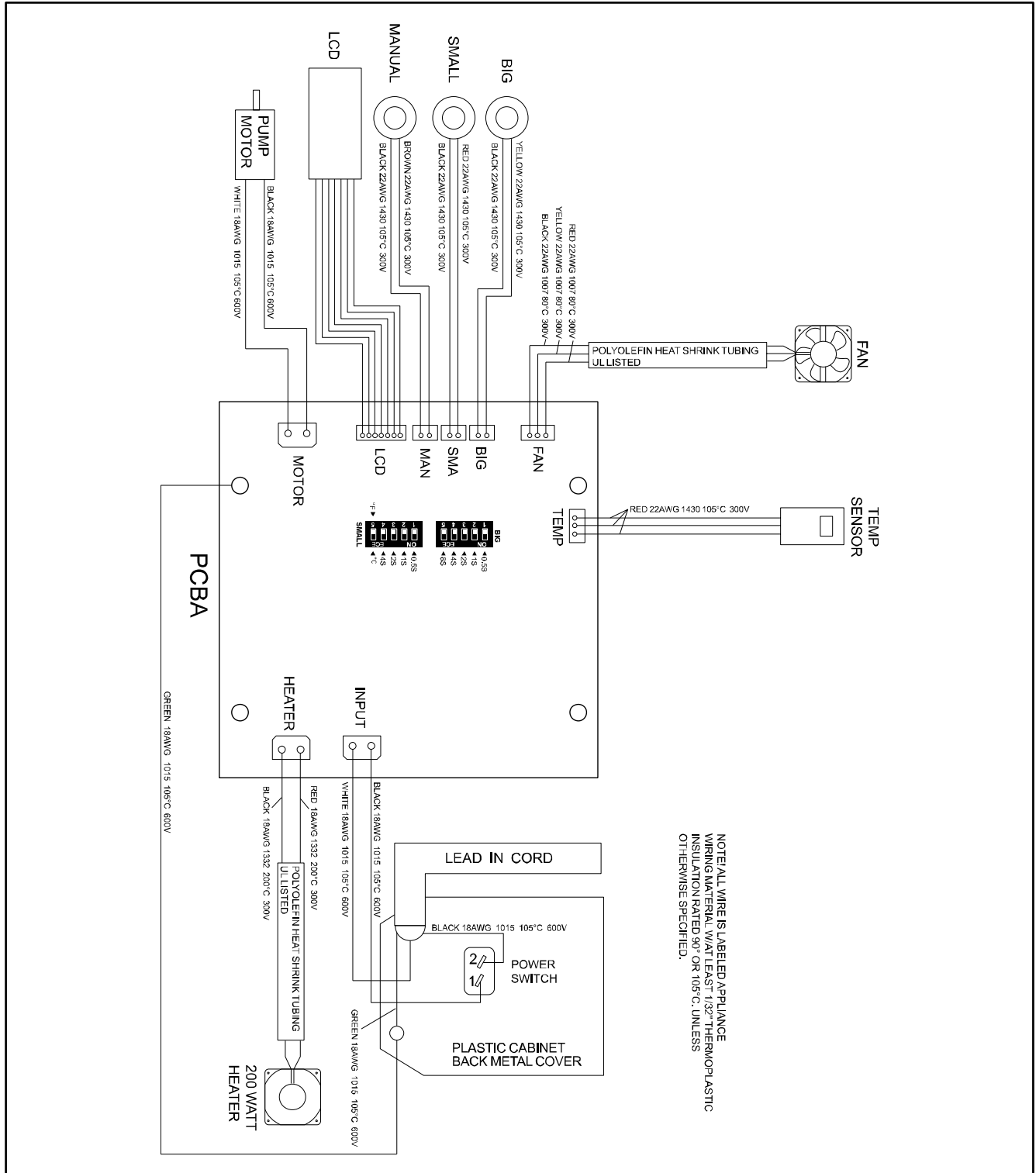



## WARRANTY

Gold Medal Products Co. warrants to the original purchaser each item of its manufacture to be free of defects in workmanship and material under normal use and service. Gold Medal Products Co.'s obligation under this warranty is limited solely to repairing or replacing parts, f.o.b. Cincinnati, Ohio, which in its judgment are defective in workmanship or material and which are returned, freight prepaid, to its Cincinnati, Ohio factory or other designated point. Except for "Perishable Parts" on specific machines, the above warranty applies for a period of two (2) years from the date of original sale to the original purchaser of equipment when recommended operating instructions and maintenance procedures have been followed. These are packed with the machine. Parts warranty is two (2) years, labor is six (6) months.

THIS WARRANTY IS IN LIEU OF ALL OTHER WARRANTIES EXPRESSED OR IMPLIED, AND OF ALL OTHER OBLIGATIONS OR LIABILITIES ON OUR PART, INCLUDING THE IMPLIED WARRANTY OF MERCHANTABILITY. THERE ARE NO WARRANTIES WHICH EXTEND BEYOND THE DESCRIPTION ON THE FACE HEREOF. In no event shall Gold Medal Products Co. be liable for special, incidental or consequential damages. No claim under this warranty will be honored if the equipment covered has been misused, neglected, damaged in transit, or has been tampered with or changed in any way. No claim under this warranty shall be honored in the event that components in the unit at the time of the claim were not supplied or approved by Gold Medal Products Co. This warranty is effective only when electrical items have been properly attached to city utility lines only at proper voltages. This warranty is not transferable without the written consent of Gold Medal Products Co.

The term "Original Purchaser" as used in this warranty shall be deemed to mean that person, firm, association, or corporation who was billed by the GOLD MEDAL PRODUCTS CO., or their authorized distributor for the equipment.

THIS WARRANTY HAS NO EFFECT AND IS VOID UNLESS THE ORIGINAL PURCHASER FIRST CALLS GOLD MEDAL PRODUCTS CO. AT 1-800-543-0862 TO DISCUSS WITH OUR SERVICE REPRESENTATIVE THE EQUIPMENT PROBLEM, AND, IF NECESSARY, FOR INSTRUCTIONS CONCERNING THE REPAIR OR REPLACEMENT OF PARTS.

*NOTE: This equipment is manufactured and sold for commercial use only.*



**GOLD MEDAL PRODUCTS CO.**

10700 Medallion Drive, Cincinnati, Ohio 45241-4807 USA

[gmpopcorn.com](http://gmpopcorn.com)

Phone: (800) 543-0862      Fax: (800) 542-1496  
(513) 769-7676              (513) 769-8500