



Instruction Manual

The Lemonator™

Model No. 5314



GOLD MEDAL® PRODUCTS CO.

10700 Medallion Drive, Cincinnati, Ohio 45241-4807 USA







Table of Contents

SAFETY PRECAUTIONS	3
INSTALLATION INSTRUCTIONS	4
Inspection of Shipment	4
Manual	4
Items Included with this Unit	4
Setup	4
OPERATING INSTRUCTIONS	5
Unit Disassembly/Assembly Instructions	6
Care and Cleaning	7
Lubricating the Unit	7
MAINTENANCE INSTRUCTIONS	8
ORDERING SPARE PARTS.....	9
The Lemonator – Parts Breakdown.....	10
WARRANTY.....	12





SAFETY PRECAUTIONS



	 DANGER
	<p>Improper installation, adjustment, alteration, service, or maintenance can cause property damage, injury, or death. Any alterations to this equipment will void the warranty and may cause a dangerous condition. This appliance is not intended to be operated by means of an external timer or separate remote-control system. NEVER make alterations to this equipment. Read the Installation, Operating, and Maintenance Instructions thoroughly before installing, servicing, or operating this equipment.</p> <p style="text-align: right; font-size: small;">014_020416</p>

	 WARNING
	<p>ALWAYS wear safety glasses when servicing this equipment.</p> <p style="text-align: right; font-size: small;">010_010914</p>

	 WARNING
	<p>No user serviceable parts inside. Refer servicing to qualified service personnel.</p> <p style="text-align: right; font-size: small;">011_051514</p>

	 WARNING
	<p>Read and understand operator's manual and all other safety instructions before using this equipment. To order copies of the operator's manual go to gmpopcorn.com or write to Gold Medal Products Co., 10700 Medallion Drive, Cincinnati, OH 45241 USA 1-(800)-543-0862</p> <p style="text-align: right; font-size: small;">022_060215</p>

	 WARNING
	<p>DO NOT allow direct contact of this equipment by the public when used in food service locations. Only personnel trained and experienced in the equipment operation may operate this equipment. Carefully read all instructions before operation.</p> <p style="text-align: right; font-size: small;">012_010914</p>

	 WARNING
	<p>This machine is NOT to be operated by minors.</p> <p style="text-align: right; font-size: small;">007_010914</p>

Note: Improvements are always being made to Gold Medal's equipment. This information may not be the latest available for your purposes. It is critical that you call Gold Medal's Technical Service Department at 1-800-543-0862 for any questions about your machine operations, replacement parts, or any service questions. (Gold Medal Products Co. does not assume any liability for injury due to careless handling and/or reckless operation of this equipment.) General images may be used in manual for reference only.

INSTALLATION INSTRUCTIONS

Inspection of Shipment

After unpacking, check thoroughly for any damage which may have occurred in transit. Claims should be filed immediately with the transportation company. The warranty does not cover damage that occurs in transit, or damage caused by abuse, or consequential damage due to the operation of this machine, since it is beyond our control (reference warranty in back of manual).

Manual

Read and understand the operator's manual and all other safety instructions before using this equipment. To order copies of the operator's manual go to gmpopcorn.com or write to Gold Medal Products Co., 10700 Medallion Drive, Cincinnati, OH 45241 USA 1-(800)-543-0862.

Items Included with this Unit



Setup

1. Remove all packaging and tape.
2. Place the Cup Holder in position (see installation images below).
3. After setup, Gold Medal recommends that this unit be cleaned prior to use (see Care and Cleaning section of this manual).



OPERATING INSTRUCTIONS

1. Place the unit on a smooth, level surface and attach it with the suction cups.
2. Put the Lemon Squeezer Bowl and one of the Cone options in place and ensure they are in the correct orientation (see image below). Use the solid cone for juice with no seeds; use the cone with holes to allow some seeds and pulp to pass through.
3. Place a cup or bowl under the unit to catch the juice that will be made.

For a small cup: Put Cup Holder in the DOWN position and set the cup on the holder.

For a large cup: Put Cup Holder in the UP position, to allow the cup to fit under the unit.

4. Place a lemon half (with the cut side down) onto the Lemon Squeezer Cone.
5. Remove hands and fingers from the squeeze area and all other moving parts before attempting to lower the handle.
6. Lower the handle and apply pressure to squeeze the juice from the lemon half.
7. Guide handle back to open position before releasing a grip on the handle (springs on the guide rods allow handle to remain in the open position).
8. Remove all rind and remaining seeds before repeating the process.

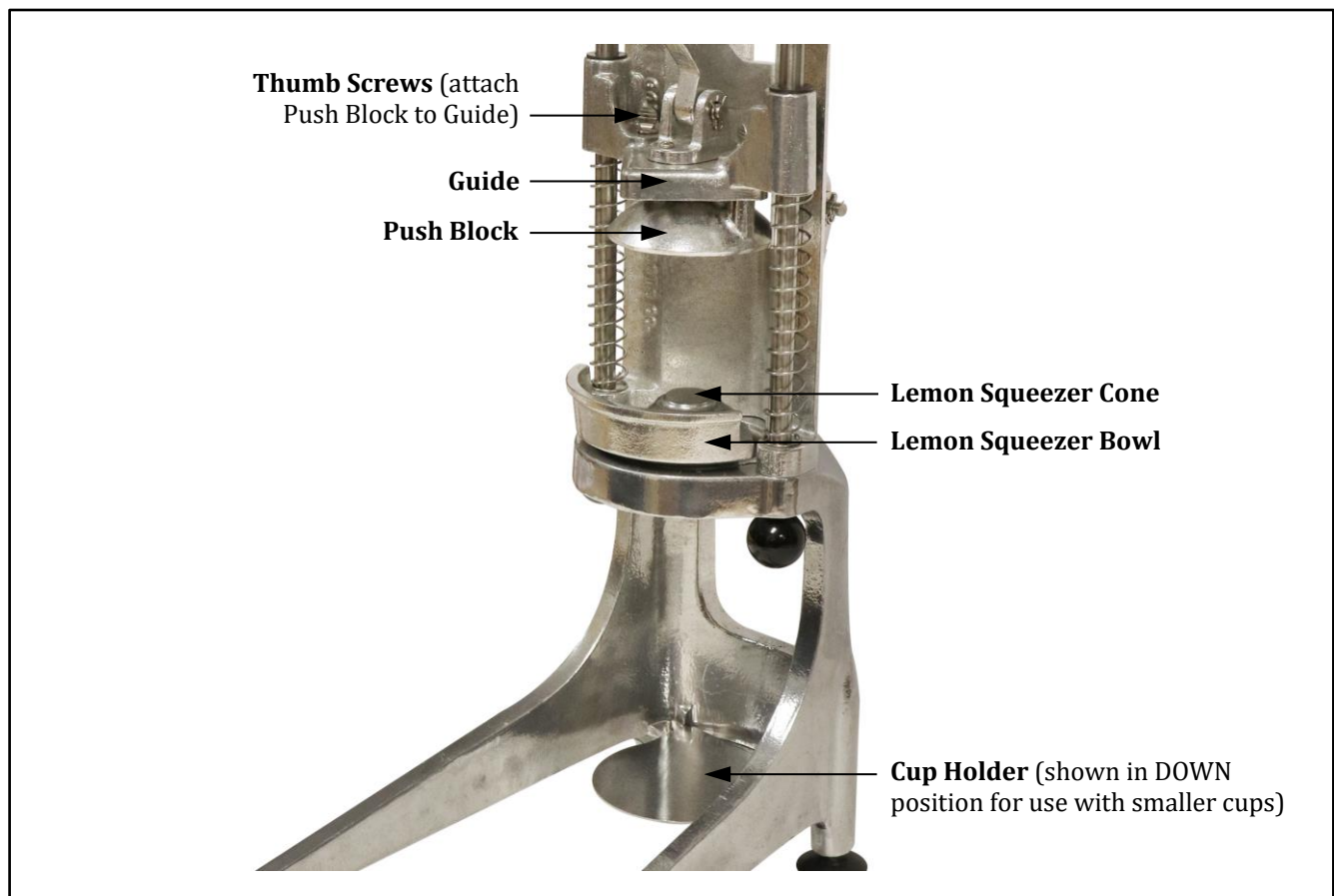



Unit Disassembly/Assembly Instructions

The following instructions are for disassembling and assembling the Lemonator.

Use the Steps below to disassemble unit for general cleaning or repair:

Step 1: Lift the Lemon Squeezer Cone and Bowl out of the stand.

Step 2: Remove the 2 thumb screws on the Guide to remove the Push Block.



Step 3: As needed, the unit can be disassembled further by removing the 2 bottom Knobs securing the Stand, then lift the upper portion of the unit off the Stand.

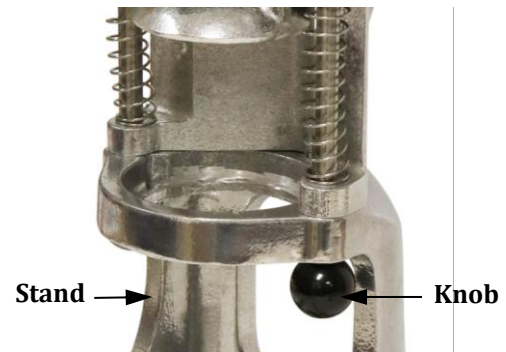

Step 4: Remove the Hitch Pins and Pins to release the Handle and Yoke. Then, remove the upper Knobs to pull the Guide Rods out of the frame, springs, and guide.

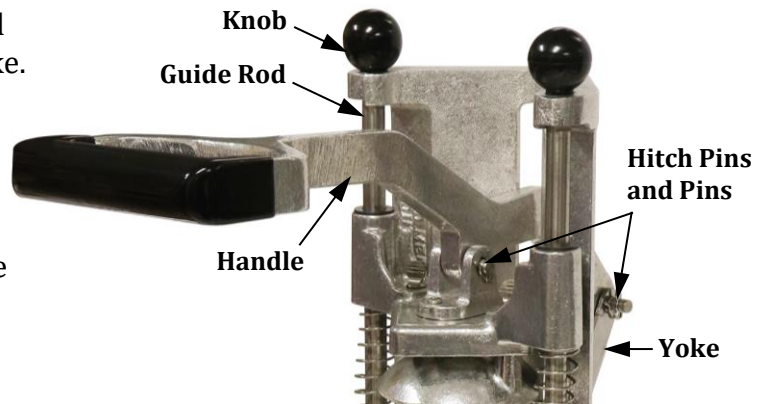

Step 5: Reassemble unit in reverse order.



Care and Cleaning

Good sanitation practice demands that all food preparation equipment be cleaned regularly (only use non-toxic, food grade cleaners). A clean looking, well-kept machine is one of the best ways of advertising your product.

Follow the directions below to clean and sanitize the unit each day after use. (Reference the Disassembly/Assembly Instruction section of this manual.)

1. Make sure to clean all parts in order to sanitize them before each use.
2. The Lemon Squeezer Bowl and Cones can be taken to the sink to clean.
3. The Push Block may be disassembled and taken to the sink to clean.
4. Clean the unit with a soft cloth dampened with soap and hot water. If needed, the unit may be disassembled further for cleaning, see the Disassembly/Assembly Instruction section.

DO NOT use oven cleaners or abrasive materials as they will damage parts of the machine.



5. Thoroughly dry unit, then reassemble.



Lubricating the Unit



When needed, lubricate the guide rods with mineral oil, food grade grease, or rub them with paraffin. **DO NOT** lubricate with cooking oil (it gets sticky).



MAINTENANCE INSTRUCTIONS

	 DANGER
	<p>Improper installation, adjustment, alteration, service, or maintenance can cause property damage, injury, or death. Any alterations to this equipment will void the warranty and may cause a dangerous condition. This appliance is not intended to be operated by means of an external timer or separate remote-control system. NEVER make alterations to this equipment. Read the Installation, Operating, and Maintenance Instructions thoroughly before installing, servicing, or operating this equipment.</p> <p>014_020416</p>

	 WARNING
	<p>No user serviceable parts inside. Refer servicing to qualified service personnel.</p> <p>011_051514</p>

	 CAUTION
	<p>THE FOLLOWING SECTIONS OF THIS MANUAL ARE INTENDED ONLY FOR QUALIFIED SERVICE PERSONNEL WHO ARE FAMILIAR WITH ELECTRICAL EQUIPMENT. THESE ARE NOT INTENDED FOR THE OPERATOR.</p> <p>027_010914</p>



ORDERING SPARE PARTS

1. Identify the needed part by checking it against the photos, illustrations, and/or parts list. (General images may be used in manual for reference only.)
2. Use only approved replacement parts when servicing this unit.
3. When ordering, please include part number, part name, and quantity needed.
4. Please include your model number, serial number, and date of manufacture (located on the machine nameplate/data plate) with your order.
5. Address all parts orders to Parts Department, Gold Medal Products Co., 10700 Medallion Drive, Cincinnati, Ohio 45241-4807

or place orders by phone or online:

Phone: (800) 543-0862
(513) 769-7676

Fax: (800) 542-1496
(513) 769-8500

E-mail: info@gmpopcorn.com
Web Page: gmpopcorn.com



The Lemonator – Parts Breakdown

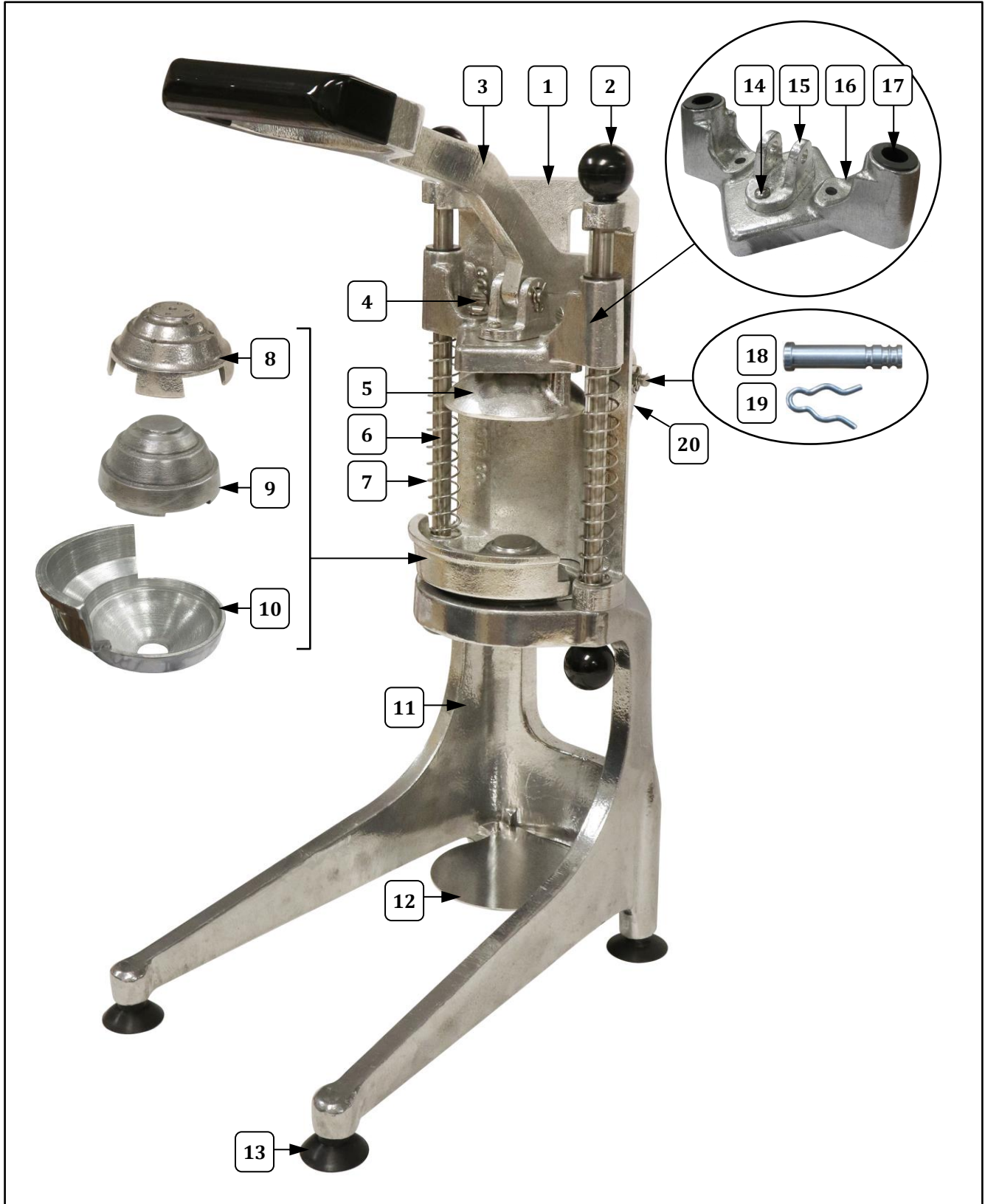



The Lemonator – Parts List

Item	Part Description	Part Number
		5314
1	FRAME	38371
2	KNOB DUMP HANDLE	47110
3	HANDLE LEVER	38374
4	THUMB SCREW 1/4-20 X 3/4" (2 required)	38379
5	PUSH BLOCK	111334
6	GUIDE ROD	38376
7	RETURN SPRING (one used on each Guide Rod)	111480
8	CONE (with seeds)	114341
9	CONE (no seeds)	111141
10	BOWL	111145
11	STAND ASSEMBLY	114418
12	CUPHOLDER	114199
13	1.5IN SUCTION CUP (4 required)	114410
14	10-24 X 7/8 M/S 18-8	38383
15	PIVOT BLOCK	38385
16	GUIDE WITH BEARINGS	38386
17	NYLON STD FLANGE BEARING	38382
18	PIN	38377
19	#3 EXTERNAL HITCH PIN	38384
20	YOKE	38375



Model 5314 parts are covered by a 10 Year Limited Warranty.

WARRANTY

Gold Medal Products Co. warrants to the original purchaser each item of its manufacture to be free of defects in workmanship and material under normal use and service. Gold Medal Products Co.'s obligation under this warranty is limited solely to repairing or replacing parts, f.o.b. Cincinnati, Ohio, which in its judgment are defective in workmanship or material and which are returned, freight prepaid, to its Cincinnati, Ohio factory or other designated point. Except for "Perishable Parts" on specific machines, the above warranty applies for a period of two (2) years from the date of original sale to the original purchaser of equipment when recommended operating instructions and maintenance procedures have been followed. These are packed with the machine. Parts warranty is two (2) years, labor is six (6) months.

THIS WARRANTY IS IN LIEU OF ALL OTHER WARRANTIES EXPRESSED OR IMPLIED, AND OF ALL OTHER OBLIGATIONS OR LIABILITIES ON OUR PART, INCLUDING THE IMPLIED WARRANTY OF MERCHANTABILITY. THERE ARE NO WARRANTIES WHICH EXTEND BEYOND THE DESCRIPTION ON THE FACE HEREOF. In no event shall Gold Medal Products Co. be liable for special, incidental or consequential damages. No claim under this warranty will be honored if the equipment covered has been misused, neglected, damaged in transit, or has been tampered with or changed in any way. No claim under this warranty shall be honored in the event that components in the unit at the time of the claim were not supplied or approved by Gold Medal Products Co. This warranty is effective only when electrical items have been properly attached to city utility lines only at proper voltages. This warranty is not transferable without the written consent of Gold Medal Products Co.

The term "Original Purchaser" as used in this warranty shall be deemed to mean that person, firm, association, or corporation who was billed by the GOLD MEDAL PRODUCTS CO., or their authorized distributor for the equipment.

THIS WARRANTY HAS NO EFFECT AND IS VOID UNLESS THE ORIGINAL PURCHASER FIRST CALLS GOLD MEDAL PRODUCTS CO. AT 1-800-543-0862 TO DISCUSS WITH OUR SERVICE REPRESENTATIVE THE EQUIPMENT PROBLEM, AND, IF NECESSARY, FOR INSTRUCTIONS CONCERNING THE REPAIR OR REPLACEMENT OF PARTS.

NOTE: This equipment is manufactured and sold for commercial use only.



GOLD MEDAL® PRODUCTS CO.

10700 Medallion Drive, Cincinnati, Ohio 45241-4807 USA

gmpopcorn.com

Phone: (800) 543-0862 Fax: (800) 542-1496
(513) 769-7676 (513) 769-8500

© 2022 – The text, descriptions, graphics, layout, and other material in this publication are the exclusive property of Gold Medal Products Co. and shall not be used, copied, reproduced, or published in any fashion, including website display, without its express written consent.