

# Econo-16

## Models 2024, 2024ST

### 16oz. Popcorn Machine

#### Instruction Manual







 **GOLD MEDAL**®



**FUNFOOD EQUIPMENT AND SUPPLIES**



Cincinnati, OH 45241-4807 USA



# SAFETY PRECAUTIONS

	 <b>DANGER</b>
	<p>Machine must be properly grounded to prevent electrical shock to personnel. Failure to do so could result in serious injury, or death.            DO NOT immerse any part of this equipment in water.            DO NOT use excessive water when cleaning.            Keep cord and plug off the ground and away from moisture.            Always unplug the equipment before cleaning or servicing.            Make sure all machine switches are in the OFF position before plugging the equipment into the receptacle.</p> <p style="text-align: right; font-size: small;">008_051514</p>

	 <b>DANGER</b>
	<p>Improper installation, adjustment, alteration, service, or maintenance can cause property damage, injury, or death. Any alterations to this equipment will void the warranty and may cause a dangerous condition. This appliance is not intended to be operated by means of an external timer or separate remote-control system. NEVER make alterations to this equipment. Read the Installation, Operating, and Maintenance Instructions thoroughly before installing, servicing, or operating this equipment.</p> <p style="text-align: right; font-size: small;">014_020416</p>



	 <b>WARNING</b>
	<p>To avoid burns, DO NOT touch the kettle or any heated surface. DO NOT place or leave objects in contact with heated surfaces.</p> <p style="text-align: right; font-size: small;">013_092414</p>



	 <b>WARNING</b>
	<p>ALWAYS wear safety glasses when servicing this equipment.</p> <p style="text-align: right; font-size: small;">010_010914</p>

	 <b>WARNING</b>
	<p>No user serviceable parts inside. Refer servicing to qualified service personnel.</p> <p style="text-align: right; font-size: small;">011_051514</p>

	 <b>WARNING</b>
	<p>Read and understand operator's manual and all other safety instructions before using this equipment. To order copies of the operator's manual go to <a href="http://gmpopcorn.com">gmpopcorn.com</a> or write to Gold Medal Products Co., 10700 Medallion Drive, Cincinnati, OH 45241 USA 1-(800)-543-0862</p> <p style="text-align: right; font-size: small;">022_060215</p>

## SAFETY PRECAUTIONS (continued)

	 <b>WARNING</b>
	DO NOT allow direct contact of this equipment by the public when used in food service locations. Only personnel trained and experienced in the equipment operation may operate this equipment. Carefully read all instructions before operation. <small>012_010914</small>

	 <b>WARNING</b>
	This machine is NOT to be operated by minors. <small>007_010914</small>

**Note:** Improvements are always being made to Gold Medal's equipment. This information may not be the latest available for your purposes. It is critical that you call Gold Medal's Technical Service Department at 1-800-543-0862 for any questions about your machine operations, replacement parts, or any service questions. (Gold Medal Products Co. does not assume any liability for injury due to careless handling and/or reckless operation of this equipment.) General images may be used in manual for reference only.

# INSTALLATION INSTRUCTIONS

## Inspection of Shipment

After unpacking, check thoroughly for any damage which may have occurred in transit. Claims should be filed immediately with the transportation company. The warranty does not cover damage that occurs in transit, or damage caused by abuse, or consequential damage due to the operation of this machine, since it is beyond our control (reference warranty in back of manual).

## Manual

Read and understand the operator's manual and all other safety instructions before using this equipment. To order copies of the operator's manual go to [gmpopcorn.com](http://gmpopcorn.com) or write to Gold Medal Products Co., 10700 Medallion Drive, Cincinnati, OH 45241 USA 1-(800)-543-0862.

## Model Description

**Model 2024:** 16 oz. Econo-16 Popper with LED cabinet lighting, and a red dome.

**Model 2024ST:** 16 oz. Econo-16 Popper with LED cabinet and sign lighting, and stainless steel dome.

## Setup



This unit has been tested at the factory.

1. Remove all packaging and tape prior to operation.
2. Place the unit on a sturdy, level base.
3. The door knobs are shipped facing the inside of the machine. Re-adjust knobs to face the outside of the machine.
4. After setup, unit should be cleaned prior to use (see Care and Cleaning section of this manual).

## Electrical Requirements

The following power supply must be provided:

**Model 2024 and 2024ST:** 120 V~, 1900 W, 60 Hz

	 <b>DANGER</b>
<p>Machine must be properly grounded to prevent electrical shock to personnel. Failure to do so could result in serious injury, or death.            DO NOT immerse any part of this equipment in water.            DO NOT use excessive water when cleaning.            Keep cord and plug off the ground and away from moisture.            Always unplug the equipment before cleaning or servicing.            Make sure all machine switches are in the OFF position before plugging the equipment into the receptacle.</p>	
<small>008_051514</small>	

A certified electrician must furnish sufficient power for proper machine operation and install any supplied receptacle. We recommend this equipment be on a dedicated and protected circuit. Failure to wire properly will void the warranty and may result in damage to the machine. It is Gold Medal Products Co.'s recommendation that this machine be plugged directly into a wall outlet. The use of extension cords is not recommended due to safety concerns, and may cause sacrificed and/or reduced performance. Make sure cord is located to prevent a trip hazard or unit upset.

## Before You Plug In Machine

1. Make sure all machine switches are OFF before plugging equipment into receptacle.
2. Make sure wall outlet can accept the grounded plugs (where applicable) on the power supply cord.
3. The wall outlet must have the proper polarity. If in doubt, have a competent electrician inspect the outlet and correct if necessary.
4. **DO NOT** use a grounded to un-grounded receptacle adapter (where applicable).
5. Install unit in a level position.

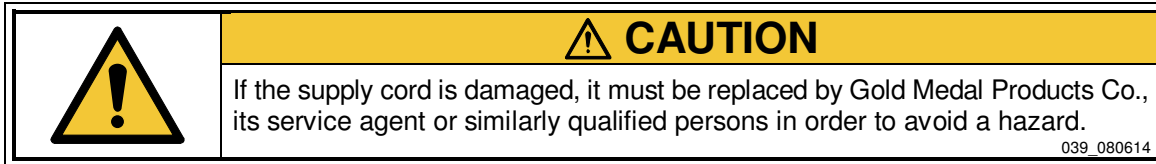

# OPERATING INSTRUCTIONS

## CONTROLS AND THEIR FUNCTIONS

### LIGHT SWITCH

Operates cabinet lighting (and sign lighting for Model 2024ST).

### WARMER SWITCH

Operates the heaters for the heated corn pan.

### KETTLE HEAT SWITCH (and Indicator Light)

Operates the heating elements in the popping kettle. The Indicator Light will turn ON when the Kettle Heat Switch is ON.

### KETTLE MOTOR SWITCH

Operates the kettle agitator motor.

## Popping Instructions

### Amount of Popcorn and Oil – Salted Popcorn

The popper is equipped with a corn, salt, and oil measure. We recommend flavored and colored coconut oil. Popcorn popped in coconut oil stays fresh longer and does not leave black deposits in the kettle like other oils. Use only top quality, fresh popcorn from reputable suppliers.

Kettle Size	Popcorn Charge	Oil Charge	Flavacol (Salt)
16 oz.	16 oz. (473 ml)	5 oz. (148 ml)	1.5 Tblsp. (20cc)

For best results use Mega-Pop® 16 oz. premeasured pouches (Item# 2846).

### Popping Standard (Salted) Popcorn

1. Turn all switches ON.
2. To determine when kettle is ready to pop corn (about 4 minutes), test pop three kernels of corn in one ounce (30 ml) of popping oil. When kernels pop, kettle is ready.
3. Lift kettle lid and load Mega-Pop® premeasured popcorn and oil pouch, or pour in popcorn and Flavacol, then add oil in premeasured amount; close lid.
4. When corn has finished popping, gently dump the popcorn.
5. On final kettle of corn, turn Kettle Heat Switch OFF just as lids are forced open by the popping corn. This procedure saves electricity, since kettle has plenty of heat, and helps eliminate smoke/odor from any oil residue that remains after popping has stopped.
6. When finished popping, turn KETTLE HEAT and KETTLE MOTOR switches OFF.

**NEVER LEAVE THE HEAT ON WHEN YOU ARE NOT POPPING CORN!**

# Care and Cleaning

	 <b>DANGER</b>
	<p>Machine must be properly grounded to prevent electrical shock to personnel. <b>DO NOT immerse in water.</b> DO NOT clean appliance with a water jet. Always unplug the equipment before cleaning or servicing.</p> <p style="text-align: right; font-size: small;">025_111616</p>

	 <b>WARNING</b>
	<p>To avoid serious burns, DO NOT touch the kettle while it is hot!</p> <p style="text-align: right; font-size: small;">028_082715</p>

Good sanitation practice demands that all food preparation equipment be cleaned regularly (only use non-toxic, food grade cleaners). A clean looking, well-kept machine is one of the best ways of advertising your product.

**Note:** It is extremely important to follow all cleaning procedures, otherwise parts damage and equipment failure will result. The warranty does not cover parts that are damaged due to improper cleaning.

## Daily Kettle Cleaning Instructions

**CAUTION:** A hot kettle will cause burns if you touch it with your hand. Allow kettle to cool at least 1 hour before attempting to clean. **DO NOT** use ice or water to cool down a hot kettle! Severe kettle damage will result!

1. When cool, wipe **outside** of kettle with a clean, soft cloth. **DO NOT** use oven cleaners or abrasive materials as they will damage the kettle.
2. Every night, mix Gold Medal's Heat'n Kleen solution (Item No. 2095), 2 tablespoons per gallon of water. It is not necessary to use the entire gallon at once; only use enough to fill the kettle 1/2 inch deep.
3. Turn kettle heat ON. When water starts to boil, turn kettle heat OFF.
4. Allow to cool at least 1 hour, then dump solution into a bucket and wipe inside of kettle with a clean cloth. Make sure all solution goes into the bucket; do not spill any in the interior of machine.

For an extra dirty kettle, the process may be repeated; or, after turning kettle heat OFF, allow solution to sit in kettle overnight. The next morning, dump solution into a bucket and wipe inside of kettle with a clean cloth.

5. With unit OFF and unplugged, wipe kettle lead cord with a clean SLIGHTLY damp cloth. **DO NOT get moisture into the kettle lead-in cord, severe damage will result.**

## Daily Unit Cleaning Instructions

1. Turn machine OFF, unplug unit and allow it to cool before attempting to clean.
2. Clean all pans/accessories in order to sanitize them before each use.
3. Take a clean, SLIGHTLY damp cloth and wipe excess grease from glass and cabinet.

4. Wipe stainless steel parts with a clean cloth and cleaner designed for stainless steel, such as Gold Medal Watchdog Stainless Cleaner (Item No. 2088).

**DO NOT** use oven cleaners or abrasive materials as they will damage parts of machine.

5. Clean glass panels with glass cleaner. Gold Medal Watchdog Glass Cleaner (Item No. 2588) is recommended.

Ammonia cleaners will damage plastic doors/panels. Use only non-ammonia cleaners, such as Gold Medal Watchdog Glass Cleaner (Item No. 2588).

6. The popcorn machine is equipped with an efficient and durable filtration system. The filter should be cleaned every week to maintain maximum efficiency. Clean filter in warm soapy water, then rinse and allow to dry overnight. Reinstall filter to its original position.

# Troubleshooting

Issue	Possible Cause	Solution
<b>Power to the Unit</b>	A. Power to the Unit	A. Make sure the unit's power cord is plugged in.
<b>Kettle Does Not Heat</b>	A. Power to the Kettle B. Kettle Heat Switch C. Heating Element	A. Make sure kettle lead-in cord is plugged in and twisted to lock into the kettle receptacle. B. Have a qualified service person check the voltage to and from the Kettle Heat Switch; if switch is defective, replace it. C. Heating element in the kettle may be burned out. Check with a qualified service person for inspection/repair.
<b>Long Popping Cycles</b> (Longer than 4 minutes for Salt Popcorn)	A. Low Voltage B. Inadequate Supply Lines C. Inferior Corn	A. If the machine is operated on low voltage, this could cause the kettle not to reach the proper operating temperature. Check with a qualified electrician. B. Inadequately sized electrical supply lines or use of extension cord, in addition to being a fire hazard, would also prevent the kettle from reaching the proper operating temperature. Check with a qualified electrician. C. Inferior quality corn would result in longer popping cycles. Use only top quality hybrid popcorn from reputable suppliers. Even then, if you let your corn pick up moisture or dry out, your popping cycles will be slow.
<b>Kettle Agitator Shaft not Rotating</b>	A. Kettle Motor Switch B. Kettle Agitator Shaft/Stir Blade not rotating. ( <b>Unit must be OFF, unplugged and cool prior to checking or adjusting the agitator assembly.</b> )	A. If the kettle agitator shaft is not rotating, <b>DO NOT</b> pop corn. Make sure the Kettle Motor Switch is ON. If the switch is ON, and the shaft is not rotating, the switch or motor may be faulty, contact qualified service personnel for inspection/repair. B. If the kettle agitator shaft is not rotating, <b>DO NOT</b> pop corn. <ul style="list-style-type: none"> <li>• <b>Kettles with a FIXED Stir Rod</b> – check the clearance between the shaft with welded stir blade and the kettle bottom; it should be a minimum of 1/32" (thickness of a dime).</li> </ul> <p>To make shaft adjustments, reference the Agitator Set Collar Adjustment section.</p>

# Agitator Set Collar Adjustment

The following instructions describe how to properly adjust set collars on an agitator assembly with a fixed stir rod.

## Agitator Assembly with a FIXED Stir Rod

### Steps to Adjust Set Collars on Agitator with a Fixed Stir Rod

Agitator assembly is adjusted while fastened to the kettle (image shown for general reference only).

**Step 1.** Turn machine OFF, unplug unit, and allow it to cool completely before attempting to adjust the agitator height.

**Step 2.** Loosen the set screw in the set collar above the crossbar and below the crossbar.

**Step 3.** Place a 1/32" gauge (thickness of a dime) under the base of the agitator shaft to adjust clearance between the kettle cook surface and the shaft; reference image shown. Once adjusted, re-tighten the set screw in the set collar above the crossbar to secure shaft in place.



**Step 4.** Adjust clearance between the bottom of the crossbar and the lower set collar to 1/32" (thickness of a dime); reference image shown. Once adjusted, re-tighten set screw to secure in place.

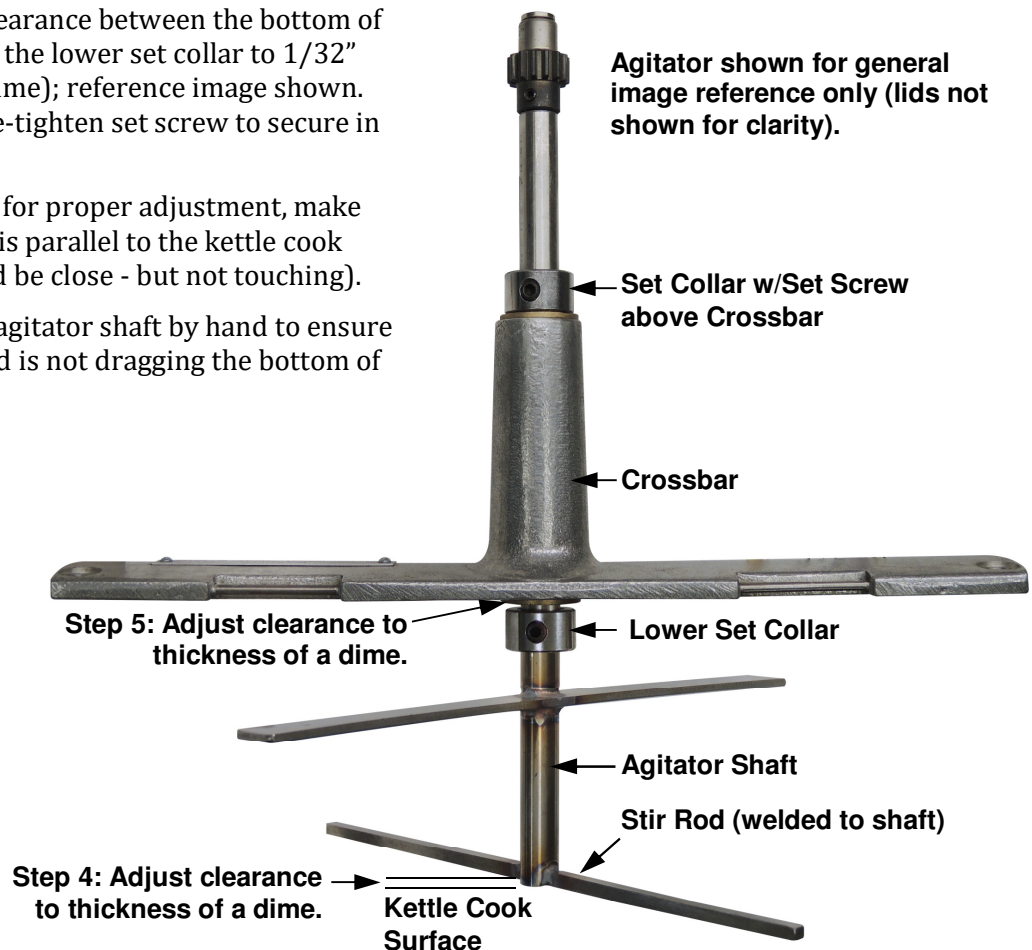

**Step 5.** To check for proper adjustment, make sure the stir rod is parallel to the kettle cook surface (it should be close - but not touching).



**Step 6.** Spin the agitator shaft by hand to ensure it spins freely and is not dragging the bottom of the kettle.





## MAINTENANCE INSTRUCTIONS

	 <b>DANGER</b>
	<p>Machine must be properly grounded to prevent electrical shock to personnel. Failure to do so could result in serious injury, or death.  <b>DO NOT</b> immerse any part of this equipment in water.  <b>DO NOT</b> use excessive water when cleaning.            Keep cord and plug off the ground and away from moisture.            Always unplug the equipment before cleaning or servicing.            Make sure all machine switches are in the OFF position before plugging the equipment into the receptacle.</p> <p style="text-align: right;">008_051514</p>

	 <b>DANGER</b>
	<p>Improper installation, adjustment, alteration, service, or maintenance can cause property damage, injury, or death. Any alterations to this equipment will void the warranty and may cause a dangerous condition. This appliance is not intended to be operated by means of an external timer or separate remote-control system. <b>NEVER</b> make alterations to this equipment. Read the Installation, Operating, and Maintenance Instructions thoroughly before installing, servicing, or operating this equipment.</p> <p style="text-align: right;">014_020416</p>

	 <b>WARNING</b>
	<p>No user serviceable parts inside. Refer servicing to qualified service personnel.</p> <p style="text-align: right;">011_051514</p>

	 <b>CAUTION</b>
	<p>THE FOLLOWING SECTIONS OF THIS MANUAL ARE INTENDED ONLY FOR QUALIFIED SERVICE PERSONNEL WHO ARE FAMILIAR WITH ELECTRICAL EQUIPMENT. THESE ARE NOT INTENDED FOR THE OPERATOR.</p> <p style="text-align: right;">027_010914</p>

## ORDERING SPARE PARTS

1. Identify the needed part by checking it against the photos, illustrations, and/or parts list. (General images may be used in manual for reference only.)
2. Use only approved replacement parts when servicing this unit.
3. When ordering, please include part number, part name, and quantity needed.
4. Please include your model number, serial number, and date of manufacture (located on the machine nameplate/data plate) with your order.
5. Address all parts orders to:

Parts Department  
Gold Medal Products Co.  
10700 Medallion Drive  
Cincinnati, Ohio 45241-4807

Or, place orders by phone or online:

Phone: (800) 543-0862  
(513) 769-7676  
Fax: (800) 542-1496  
(513) 769-8500  
E-mail: [info@gmpopcorn.com](mailto:info@gmpopcorn.com)  
Web Page: [gmpopcorn.com](http://gmpopcorn.com)

## 16 oz. Kettle Assembly (55199) – Agitator Assembly View

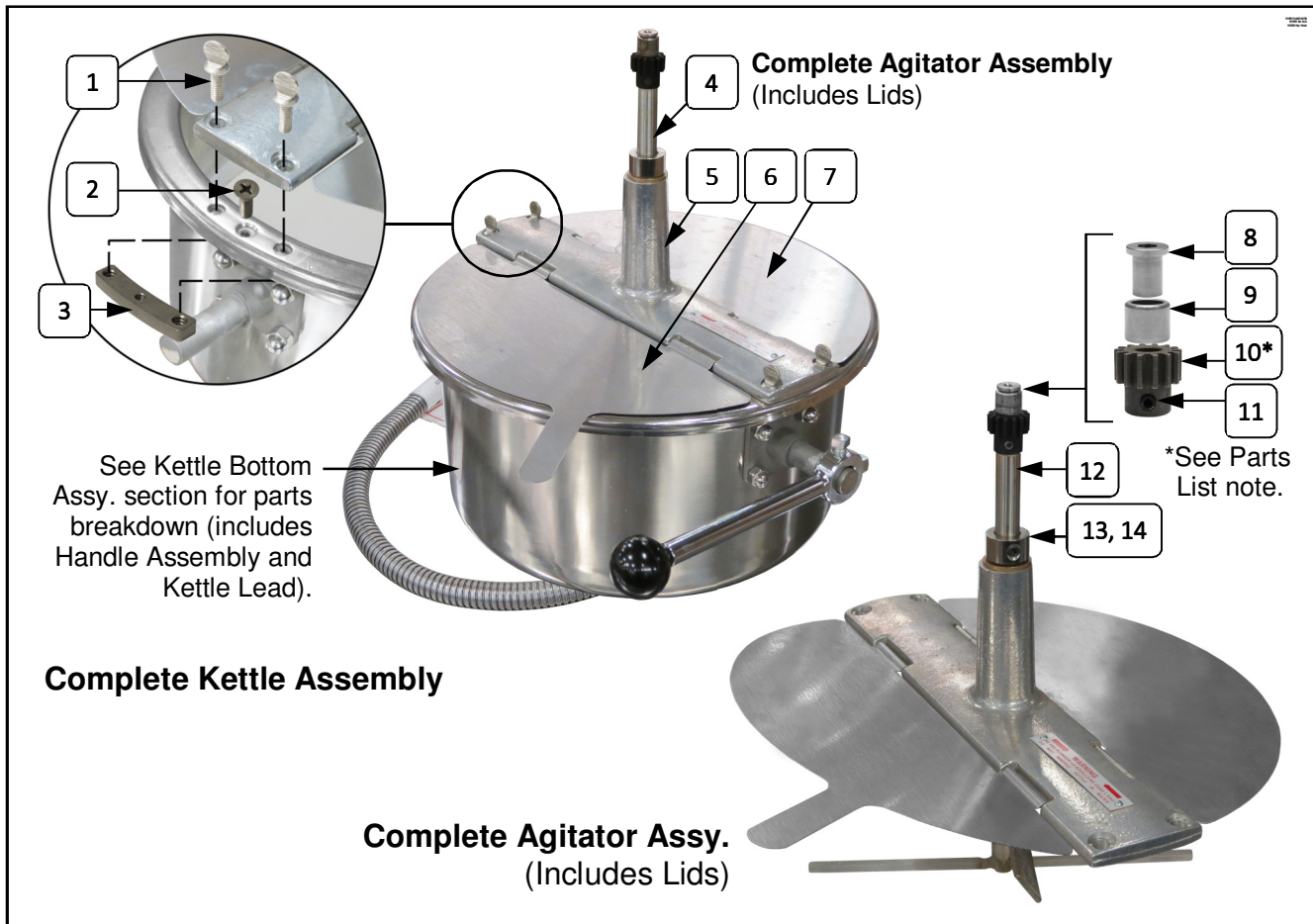

Item	Part Description	Part Number
		55199
1	1/4-20 X 1 THUMB SCREW	47691
2	8-32 X 1/2 PHILL FLAT M/S ZINC	20066
3	THREADED BLOCK	61167
4	LID & AGITATOR ASSEMBLY (Complete Assy.)	41181
5	CROSSBAR ASSEMBLY	41180
6	FRONT LID	41123
7	REAR LID	41120
8	AGITATOR BEARING HUB	43434
9	NEEDLE BEARING	47106
10*	SPUR GEAR KIT (Includes 2 gears with set screws. Always replace Agitator Spur Gear and Kettle Drive Motor Gear as a set.)	47059K
11	10-32 X 3/16 SET SCREW	41742
12	AGITATOR SHAFT ASSEMBLY	41093
13	1/2 ID X 7/8 OD SET COLLAR	47326
14	1/4-20 X 3/16 SET SCREW	47751

# 16 oz. Kettle Assembly (55199) – Kettle Bottom Assembly

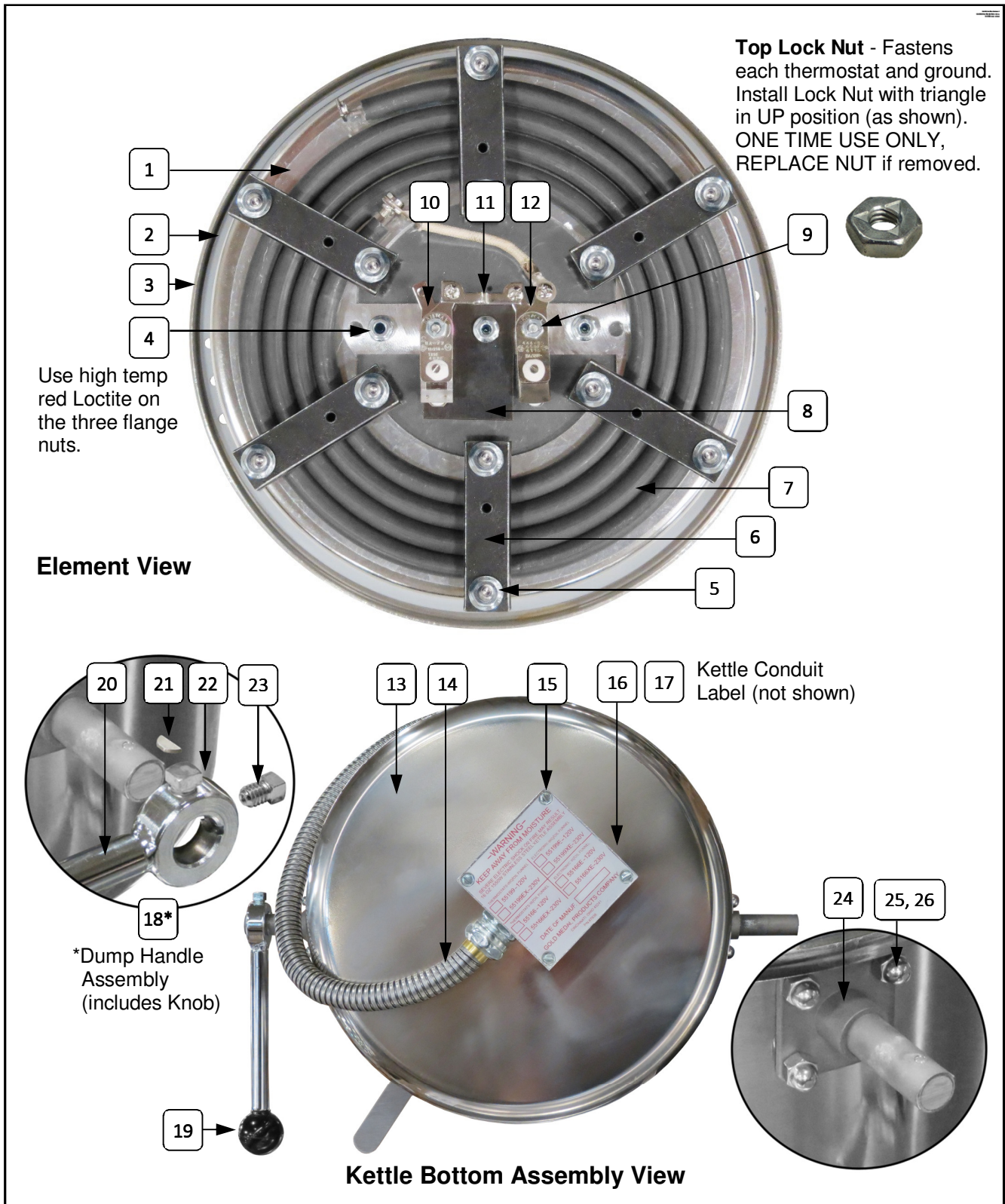

## 16 oz. Kettle Bottom Assembly (55199) – Parts List

Item	Part Description	Part Number
		55199
	16OZ KETTLE BOTTOM ASSY (Complete Assy.)	55200
1	TRANSFER PLATE ASSY (beneath heat element)	67944
2	KETTLE GASKET	41598
3	KETTLE WELDMENT	67892
4	8-32 SERRATED FLANGE NUT	
5	¼ - 20 SERRATED LOCK NUT	46311
6	ELEMENT CLAMP (6 required)	67894
7	1550 TUBULAR HEAT ELEMENT	67014
8	LIMIT THERMOSTAT SHIELD	67959
9	8-32 TOP LOCK NUT (always replace if removed)	67943
10	482 F THERMOSTAT (includes two 6-32 screws)	76708
11	THERMOSTAT SHUNT BAR	47193
12	550 F THERMOSTAT (includes two 6-32 screws)	77108
13	KETTLE SHELL ASSEMBLY (has Pivot Pins attached)	41081
14	KETTLE LEAD ASSEMBLY	47361
15	8-32 x 3/8 SLT HWHW M/S (fastens Nameplate to Jct. Box, and fastens Jct. Box to Kettle)	42044
16	JUNCTION BOX	47393
17	KETTLE CONDUIT LABEL	82840
18	DUMP HANDLE ASSEMBLY (assembly includes Handle, Knob, 2 SQ HD Screws, and Key)	47102
19	DUMP HANDLE KNOB	47110
20	DUMP HANDLE	47707
21	3 1/8 X ½ WOODRUFF KEY	41730
22	5/16 – 18 X ½ SQ HD SCREW	47725
23	5/16 – 18 X 3/8 SQ HD SCREW (holds key)	47662
24	PIVOT PIN	41426
25	1/4-20 ACORN NUT	42229
26	1/4-20 X 3/8 BUTTON HEAD	12492

# Cabinet Interior View (general images shown for parts reference only)

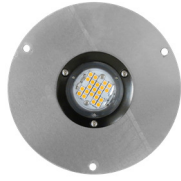

**LED Bulb Assembly**  
p/n 55625



**20 W Power Supply**  
p/n 55394 (2024)  
**60 W Power Supply**  
p/n 55586 (2024ST)



**20 W Power Supply Brkt**  
p/n 55414 (2024)  
**60 W Power Supply Brkt**  
p/n 55624 (2024ST)

**Switch, Toggle SPST (4)**  
p/n 47201

**Pilot Light 125V Red**  
p/n 41033

**Switch Box**  
p/n 41004

**Circuit Breaker 15A**  
p/n 47364

**Kettle Receptacle**  
p/n 47327

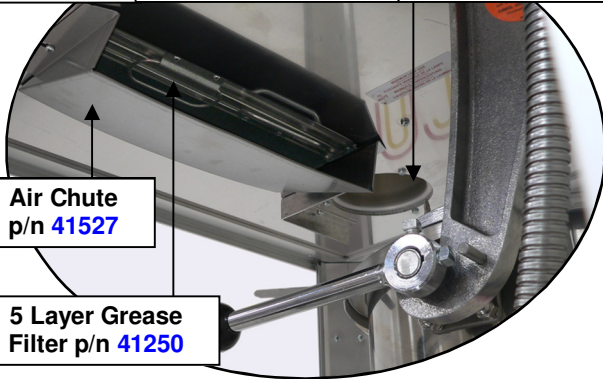

**Air Chute**  
p/n 41527

**5 Layer Grease Filter**  
p/n 41250

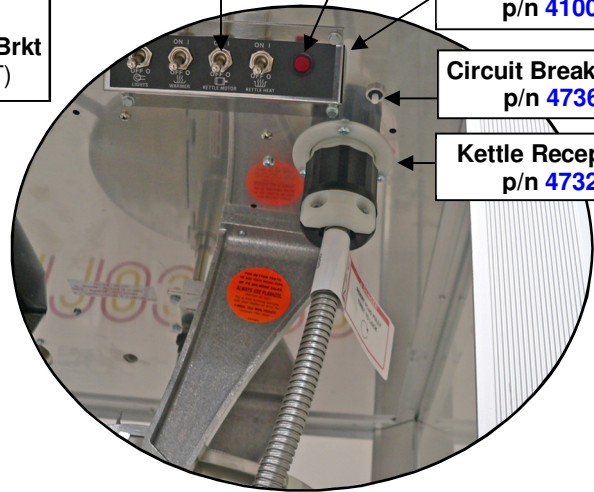

**Red Dome 2024**  
p/n 75100  
(For 2024ST, see Lighted Dome Assembly section.)

**Magnetic Catch**  
p/n 47561  
**Magnetic Catch Bracket**  
p/n 41340

**Hanger Arm Front, Assy**  
p/n 47262

**Hanger Arm Rear, Assy**  
p/n 47228

**See Kettle Assembly section.**

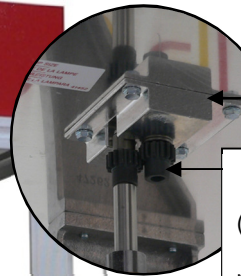

**Gear Block Assy.**  
p/n 67194

**Spur Gear Kit**  
p/n 47059K  
(Includes 2 gears with set screws. Always replace Agitator Spur Gear and Kettle Drive Motor Gear as a set.)

**See Complete Door Hardware Kit section for parts breakdown.**

**Plexiglas Door**  
p/n 47600A  
(Doors DO NOT come predrilled for hardware)

**Drop Panel Assembly**  
p/n 41017

**Bottom Corn Pan Assembly 120V**  
p/n 47450  
(Includes Corn Pan and Heat Element)

**Rubber Foot**  
p/n 41282

**Old Maid Pan**  
p/n 41838

**20A Lead-In Cord**  
(not shown)\*  
p/n 47580

**\*CAUTION:** If supply cord is damaged, it must be replaced by Gold Medal Products Co., its service agent, or similarly qualified persons in order to avoid a hazard.

## Door Hardware Kits – Individual Component Breakdown

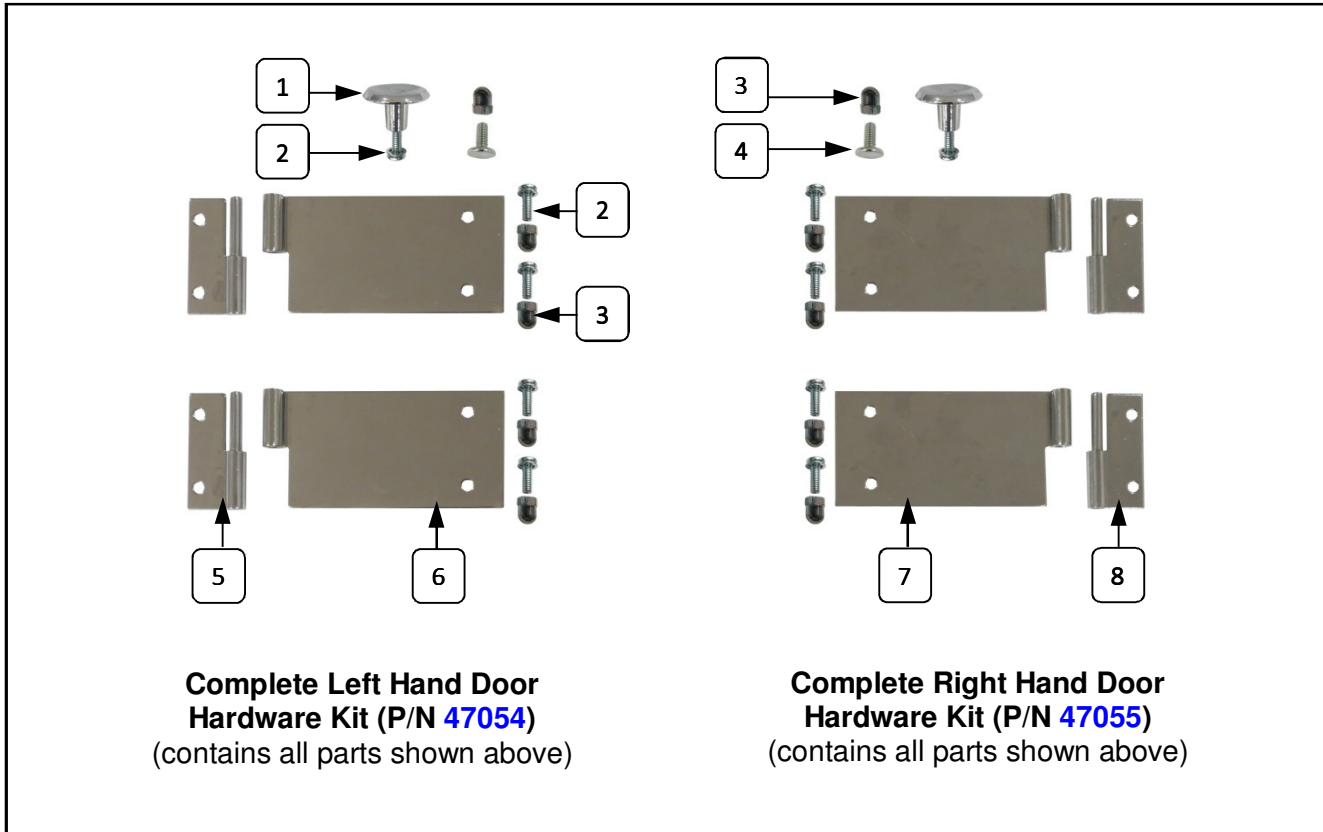

Item	Part Description	Part Number	
		47054	47055
1	DOOR KNOB	41013	41013
2	8-32 X 1/2 SCREWS PH PAN W/SEMS	47124	47124
3	ACORN NUT #8-32	47702	47702
4	TEE BOLT	75267	75267
5	MALE HINGE SHORT LEFT	41349	
6	FEMALE HINGE LONG LEFT	41352	
7	FEMALE HINGE LONG RIGHT		41351
8	MALE HINGE SHORT RIGHT		41350

## Dome Assembly (2024ST only)

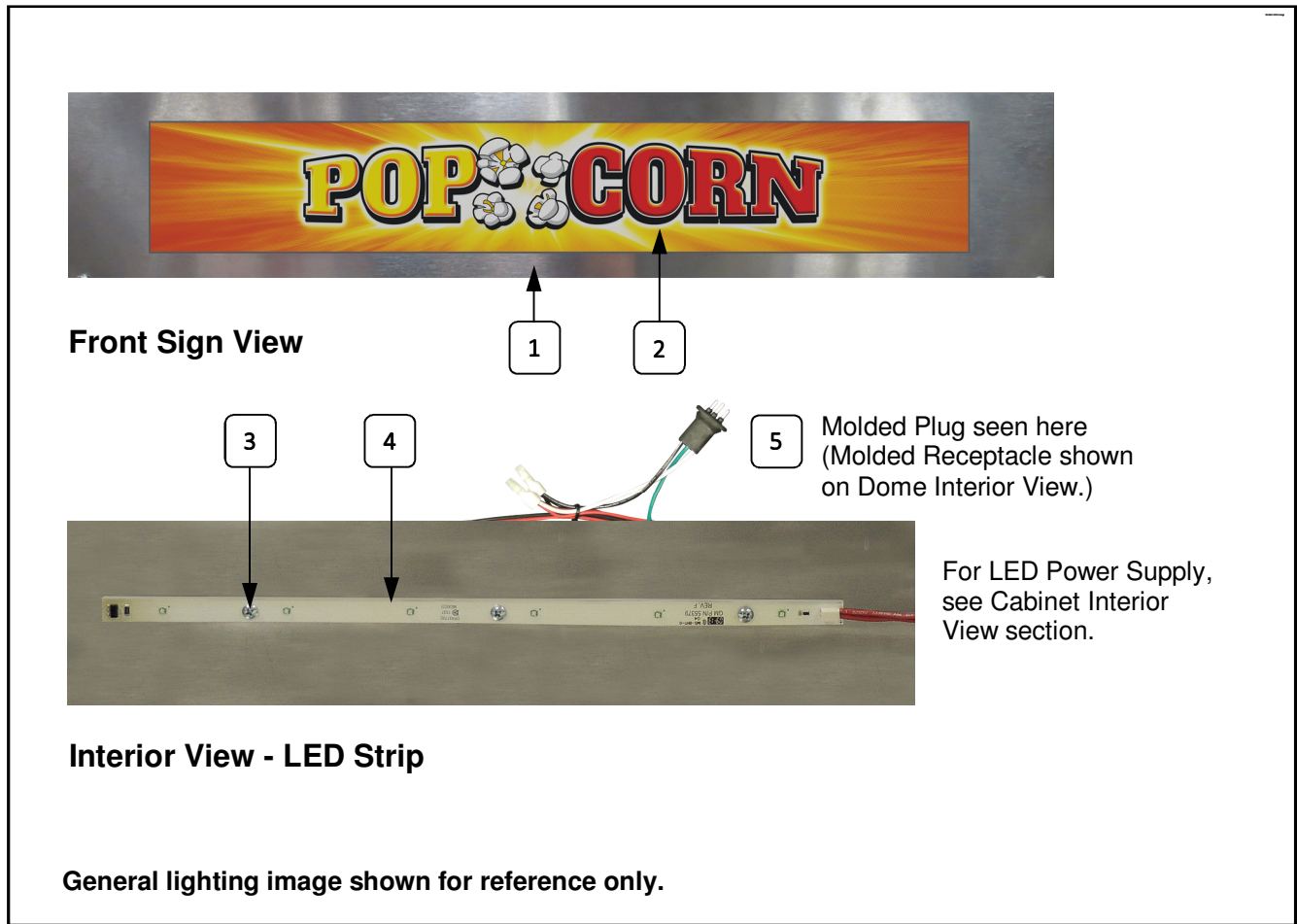

Item	Part Description	Part Number
		2024ST
1	DOME ASSEMBLY	<a href="#">61000</a>
2	POPCORN SIGN	<a href="#">111873</a>
3	8-32 PAN HD (Mounts the LED Strip)	<a href="#">74141</a>
4	LED STRIP COOL WHITE (2 REQUIRED)	<a href="#">55379</a>
5	MOLDED PLUG	<a href="#">47726</a>

## Dome Interior - Motor Plate Assembly

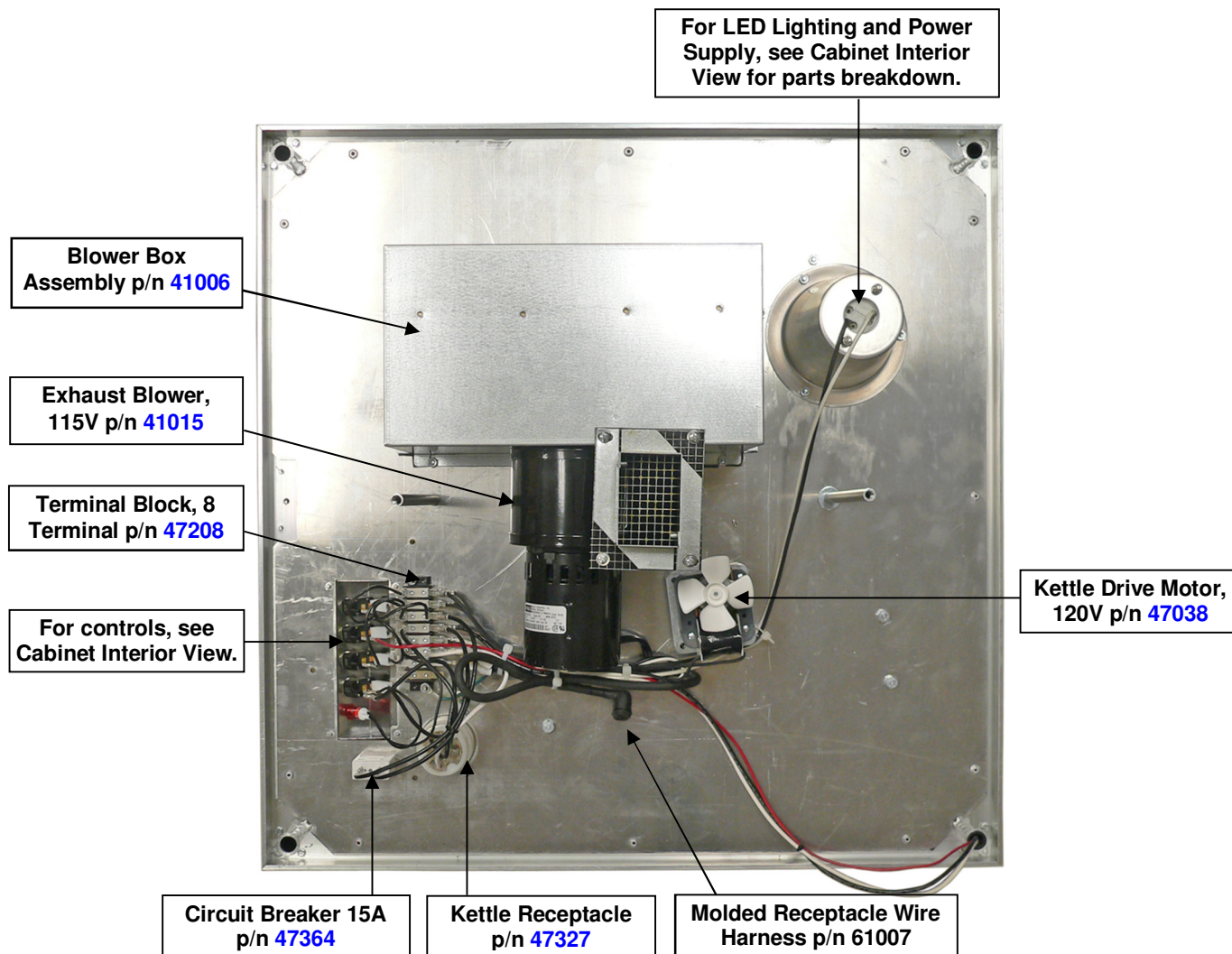

General image shown for reference only.

# ELECTRICAL SCHEMATIC

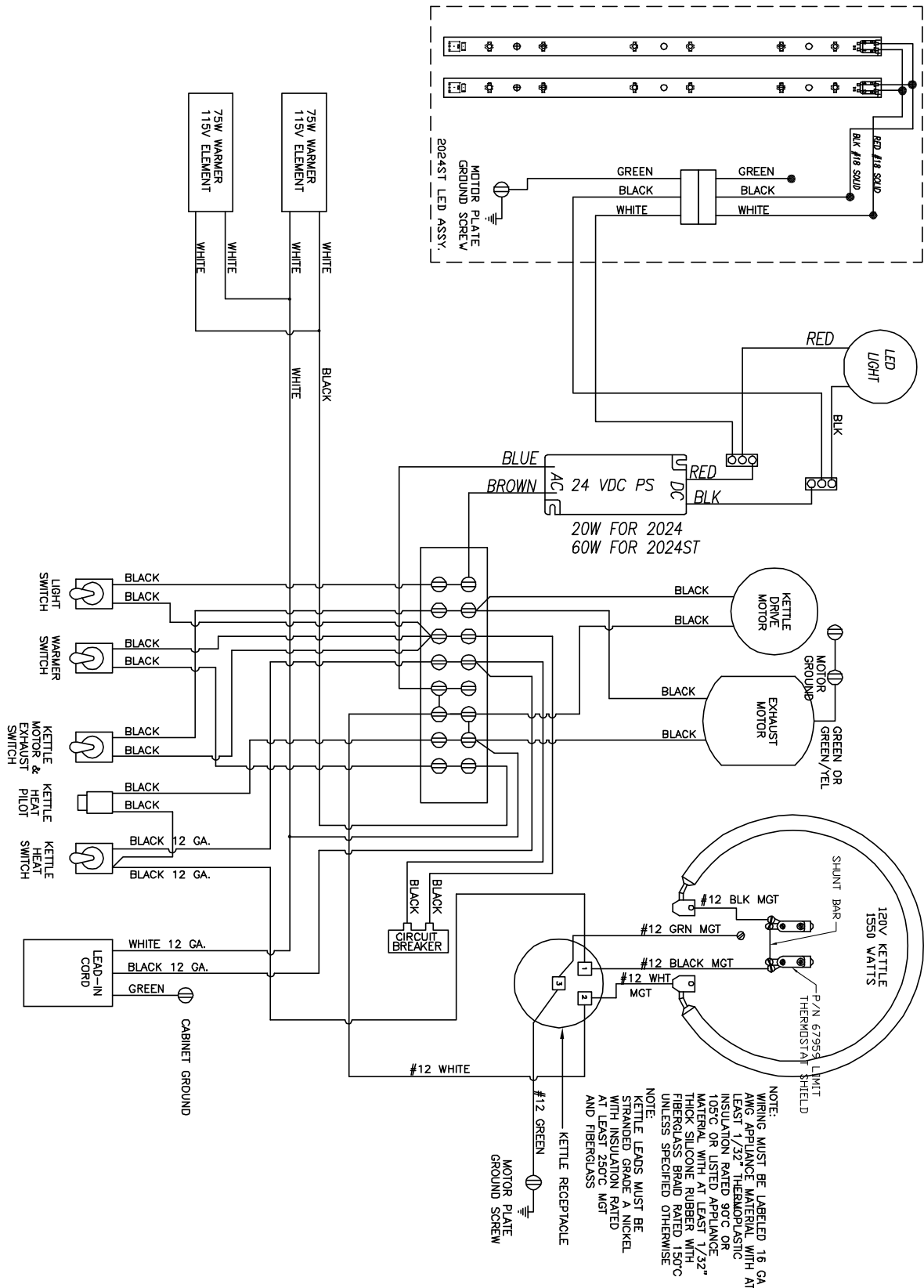

# WARRANTY

Gold Medal Products Co. warrants to the original purchaser each item of its manufacture to be free of defects in workmanship and material under normal use and service. Gold Medal Products Co.'s obligation under this warranty is limited solely to repairing or replacing parts, f.o.b. Cincinnati, Ohio, which in its judgment are defective in workmanship or material and which are returned, freight prepaid, to its Cincinnati, Ohio factory or other designated point. Except for "Perishable Parts" on specific machines, the above warranty applies for a period of two (2) years from the date of original sale to the original purchaser of equipment when recommended operating instructions and maintenance procedures have been followed. These are packed with the machine. Parts warranty is two (2) years, labor is six (6) months.

THIS WARRANTY IS IN LIEU OF ALL OTHER WARRANTIES EXPRESSED OR IMPLIED, AND OF ALL OTHER OBLIGATIONS OR LIABILITIES ON OUR PART, INCLUDING THE IMPLIED WARRANTY OF MERCHANTABILITY. THERE ARE NO WARRANTIES WHICH EXTEND BEYOND THE DESCRIPTION ON THE FACE HEREOF. In no event shall Gold Medal Products Co. be liable for special, incidental or consequential damages. No claim under this warranty will be honored if the equipment covered has been misused, neglected, damaged in transit, or has been tampered with or changed in any way. No claim under this warranty shall be honored in the event that components in the unit at the time of the claim were not supplied or approved by Gold Medal Products Co. This warranty is effective only when electrical items have been properly attached to city utility lines only at proper voltages. This warranty is not transferable without the written consent of Gold Medal Products Co.

The term "Original Purchaser" as used in this warranty shall be deemed to mean that person, firm, association, or corporation who was billed by the GOLD MEDAL PRODUCTS CO., or their authorized distributor for the equipment.

THIS WARRANTY HAS NO EFFECT AND IS VOID UNLESS THE ORIGINAL PURCHASER FIRST CALLS GOLD MEDAL PRODUCTS CO. AT 1-800-543-0862 TO DISCUSS WITH OUR SERVICE REPRESENTATIVE THE EQUIPMENT PROBLEM, AND, IF NECESSARY, FOR INSTRUCTIONS CONCERNING THE REPAIR OR REPLACEMENT OF PARTS.

*NOTE: This equipment is manufactured and sold for commercial use only.*



**GOLD MEDAL PRODUCTS CO.**

10700 Medallion Drive, Cincinnati, Ohio 45241-4807 USA

[gmpopcorn.com](http://gmpopcorn.com)

Phone: (800) 543-0862      Fax: (800) 542-1496  
(513) 769-7676              (513) 769-8500

© 2017 – The text, descriptions, graphics, layout, and other material in this publication are the exclusive property of Gold Medal Products Co. and shall not be used, copied, reproduced, or published in any fashion, including website display, without its express written consent.