



Model **C12**

Model #: \_\_\_\_\_

Serial #: \_\_\_\_\_



## Instruction Manual for Globe Slicer Models: **C9**, **C10**, and **C12**

For all after sales support, visit [www.globefoodequip.com](http://www.globefoodequip.com)

- Complete the Warranty Registration
- Find an Authorized Servicer
- View Parts Catalogs

For additional Technical Support call Globe at 1-866-260-0522.

### - IMPORTANT SAFETY NOTICE -

This manual contains important safety instructions that must be strictly followed when using this equipment.

**Maintain and use this manual as a reference for training.**



# Index

ATTENTION OWNERS AND OPERATORS.....	4
KEY COMPONENTS OF THE SLICER .....	5
GLOBE SLICER SAFETY TIPS .....	6
INSTALLATION .....	7-8
OPERATING INSTRUCTIONS.....	9-10
CLEANING & SANITIZING.....	11-14
KNIFE SHARPENING .....	15-16
INSPECTION, SIMPLE MAINTENANCE, AND REPAIR.....	17-18
TROUBLESHOOTING GUIDE .....	19



**GLOBE FOOD EQUIPMENT CO.**  
2153 DRYDEN RD.  
DAYTON, OH 45439  
Toll Free: 800-347-5423  
PHONE: 937-299-5493  
E-MAIL: [info@globefoodequip.com](mailto:info@globefoodequip.com)  
WEBSITE: [www.globefoodequip.com](http://www.globefoodequip.com)

# Attention Owners and Operators

Globe equipment is designed to provide years of safe and productive processing of food products as long as the equipment is used in accordance with the instructions in this manual and is properly maintained. Importantly, unless the operator is adequately trained and supervised, there is a possibility of serious injury. Owners of this equipment bear the responsibility to make certain that this equipment is used properly and safely. Strictly follow all of the instructions contained in this manual and the requirements of local, state and/or federal law.

Owners should not permit anyone to touch this equipment unless they are over 18 years of age, are adequately trained and supervised, and have read and understand this manual. Owners should also ensure that no customers, visitors or other unauthorized personnel come in contact with this equipment. Please remember that Globe cannot anticipate every circumstance or environment in which its equipment will be operated. It is the responsibility of the owner and the operator to remain alert to any hazards posed by the function of this equipment, particularly the sharp knife blade and all moving parts. If you are ever uncertain about a particular task or the proper method of operating this equipment, ask your supervisor, before operating equipment.

To prevent illness caused by the spread of food-borne pathogens, it is important to properly clean and sanitize the entire slicer as any surface of the slicer can become contaminated. It is the responsibility of the slicer owner/operator to follow all guidelines, instructions and laws as established by your local and state health departments and the manufacturers of chemical sanitizers.

When cleaning your slicer, pay particular attention to cracks, broken seams and any area that may collect food debris. If your slicer, or any of its parts, is damaged or broken, it may become more difficult to properly clean and sanitize the unit. If your slicer is damaged or needs repair, contact an experienced service individual immediately to ensure the slicer can be properly sanitized. If you have any questions, please contact Globe at 937-299-5493.

This manual offers information to supplement your procedures to improve the sanitization of your machine and contains a Safety Tips section listing a number of precautions to follow to help promote safe use of this equipment. Throughout the manual you will see additional warnings to help alert you to potential hazards.

**Warnings affecting your personal safety are indicated by:**



or



**Warnings related to possible damage to the equipment are indicated by:**



A wall chart with safety instructions is included with this equipment. This wall chart must be posted near the slicer within easy view of the operator. The Slicer owner must make certain that this manual is available for easy reference by any operator. Globe has put several warning labels in the English language on the slicer. French and Spanish labels are also available and can replace the English labels at the owner's discretion. If the warning labels, the wall chart, and/or this manual are misplaced, damaged or illegible, or if you require additional copies, please contact your nearest representative or contact Globe directly for these items at no charge.

Please remember that neither this manual nor the wall chart nor the warning labels replaces the need to be alert, to properly train and supervise operators, and to use common sense when using this equipment.

# Key Components of the Slicer

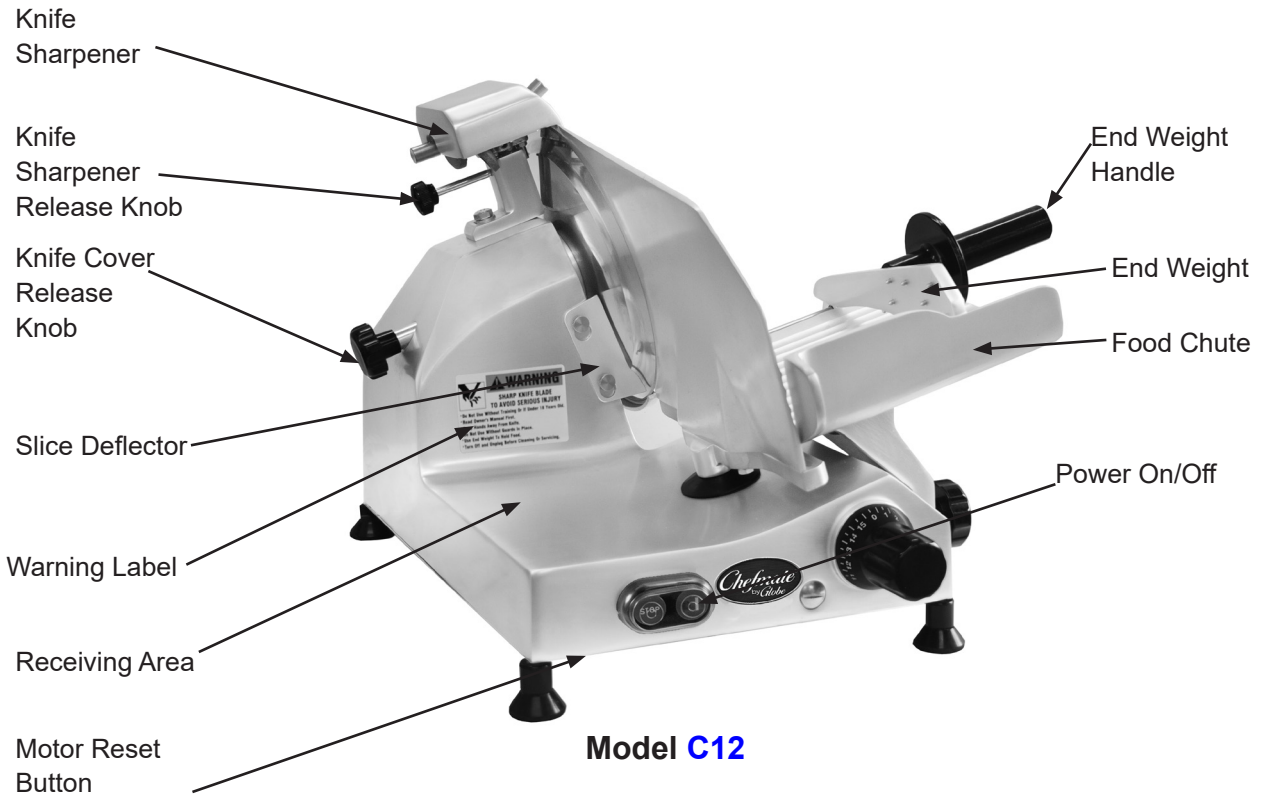

## Globe Slicer Safety Tips

# **WARNING**



## SHARP KNIFE BLADE

### TO AVOID SERIOUS PERSONAL INJURY:

- NEVER touch slicer without training and authorization from your supervisors, or if you are under 18 years of age. Read this instruction manual before operating slicer.
- **ONLY** install slicer on a level nonskid surface that is nonflammable and is located in a clean, well-lit work area away from children and visitors.
- **ALWAYS** ground slicer utilizing proper power source.
- **NEVER TOUCH KNIFE.** Keep hands and arms away from all moving parts.
- **NEVER OPERATE** slicer without knife cover and knife sharpener securely installed.
- **BE ALERT** when slicer is on and in motion.
- **NEVER HOLD THE FOOD PRODUCT WHILE SLICING.** Hold only the end weight handle to slice.
- **DO NOT CATCH SLICES WITH YOUR HAND.** Let slices drop onto receiving area.
- **ALWAYS** turn slicer OFF and turn the slice thickness dial clockwise until it stops after each use.
- **BEFORE CLEANING, SHARPENING, SERVICING, OR REMOVING ANY PARTS,** always turn slicer OFF, turn the slice thickness dial clockwise until it stops, remove food chute and unplug the power cord.
- **ALWAYS properly clean and sanitize slicer.** To prevent illness or death caused by the spread of food-borne pathogens, it is important to properly clean and sanitize the entire slicer as the surface of the slicer can become contaminated. It is the responsibility of the slicer owner/operator to follow all guidelines, instructions and laws as established by your local and state health departments and the manufacturers of chemical sanitizers.
- **USE ONLY GLOBE SLICER ACCESSORIES** properly installed.

# Installation

## **UNPACKING**

1. Unpack the slicer immediately after receipt. If the machine is found to be damaged, immediately contact us at [help@globefoodequip.com](mailto:help@globefoodequip.com) or call 1-800-347-5423 ext. 256. Please include your name, serial #, item that is damaged, explanation of the damage and photographs if possible. The damage must be reported to Globe within 7 days from the time of shipment. Refer to Globe's Freight Damage policy for more information. <https://globefoodequip.com/support/order-return-policy.html>
2. Four rubber feet, lubricating oil, and an instruction manual are included with slicer. Contact Globe or your local supplier if you did not receive all of these items.



## **TO AVOID SERIOUS PERSONAL INJURY PROPERLY INSTALL SLICER IN ADEQUATE WORK AREA**

- **ALWAYS** install equipment in a work area with adequate light and space.
- **ONLY** operate on a solid, level, nonskid surface that is nonflammable.
- **NEVER** operate slicer with a damaged power cord or power plug.
- **NEVER** operate slicer with an extension cord.
- **NEVER** bypass, alter, or modify this equipment from its original condition. Doing so can create hazards and will void warranty.
- **NEVER** operate slicer without the knife cover securely installed.
- **NEVER** operate slicer without warning label attached (Refer to page 4 for location).

## **INSTALLATION:**

1. Read this manual thoroughly before installation and operation. **DO NOT** proceed with installation and operation if you have any questions or if you do not understand everything in the manual. Contact your local representative or Globe first. Make sure to clean and sanitize entire slicer before use. Refer to this manual for cleaning and sanitizing guidelines.
2. Remove slicer from the corrugated box.
3. Make sure the rubber feet are firmly tightened.



**NEVER USE SLICER WITHOUT RUBBER FEET INSTALLED.**

4. Select a location for slicer that has a level, solid, nonskid surface that is nonflammable and is in a well-lit work area that is away from children and visitors.



**USE AT LEAST TWO PEOPLE TO LIFT SLICER UP TO THE OPERATING LOCATION. NEVER ATTEMPT TO LIFT THE SLICER ALONE.**

# Installation



**THIS MACHINE IS PROVIDED WITH A THREE-PRONG GROUNDING PLUG. THE OUTLET TO WHICH THIS PLUG IS CONNECTED MUST BE PROPERLY GROUNDED. IF THE RECEPTACLE IS NOT THE PROPER GROUNDING TYPE, CONTACT AN ELECTRICIAN. DO NOT, UNDER ANY CIRCUMSTANCES, CUT OR REMOVE THE THIRD GROUND PRONG FROM THE POWER CORD OR USE ANY ADAPTER PLUG (Fig. 7-1 and Fig. 7-2).**

5. Inspect slicer to make sure all parts have been provided.
6. Make sure knife cover, knife ring guard and knife sharpener are in place.
7. Make sure the warning label is properly positioned and legible. Instruction manual must be available near slicer.
8. Complete the warranty registration online at [www.globefoodequip.com/support/warranty-registration-form](http://www.globefoodequip.com/support/warranty-registration-form).
9. Post the provided wall chart in a visible area near the slicer to be referred to often for cleaning, sanitizing, and inspecting slicer. Refer to the wall chart and Owner's Manual for proper cleaning, sanitizing and inspection of your slicer.
10. Clean slicer using the procedures outlined in the cleaning section (pages 10 through 13) before using the slicer.
11. Contact your local representative, or Globe directly, if you have any questions or problems with the installation or operation of this slicer.



Figure 7-1 Correct



Figure 7-2 **INCORRECT**

# Operating Instructions

**⚠ WARNING**



## SHARP KNIFE BLADE

### TO AVOID SERIOUS PERSONAL INJURY:

- **NEVER** touch slicer without training and authorization from your supervisor, or if you are under 18 years of age. Read this instruction manual before operating slicer.
- **NEVER TOUCH KNIFE.** Keep hands and arms away from all moving parts.
- **NEVER OPERATE** slicer without knife cover and knife sharpener securely installed.
- **BE ALERT** when slicer is on and in motion.
- **NEVER HOLD THE FOOD PRODUCT WHILE SLICING.** Hold only the end weight handle to slice.
- **DO NOT CATCH SLICES WITH YOUR HAND.** Let slices drop onto the receiving area.
- **AFTER EACH USE, ALWAYS** turn slicer OFF and turn the slice thickness dial clockwise until it stops.
- **BEFORE CLEANING, SHARPENING, SERVICING OR REMOVING ANY PARTS,** always turn slicer OFF, turn the slice thickness dial clockwise until it stops, unplug power cord, and remove food chute.

### SLICER OPERATION

1. Tighten all knobs before slicer is used.
2. With the slicer turned OFF, pull the food chute completely towards you and place the food product onto food chute. Slice only boneless, unfrozen product with slicer. Use end weight to hold the food product in place.
3. Rotate the slice thickness dial counterclockwise to the desired setting. After slicing is complete, always turn the slice thickness dial clockwise until it stops to close slicer table.
4. Turn slicer on by pushing “Start” button. The power indicator light, located near the power on button, will illuminate.

# Operating Instructions



**DO NOT hold the food product with your hand. Never put your hand on or around the food chute when slicer is on. The food chute handle is the only part of the slicer you must touch while slicing.**

5. Use food chute handle to manually push the food chute back and forth. The food chute handle is the only part of the slicer you must touch while slicing. Do not catch slices with your hand. Let slices drop onto the receiving area.

**If a product needs to be adjusted during slicing, ALWAYS pull food chute all the way towards you. Turn OFF slicer, and close slicer table prior to adjusting the product and end weight.**



6. After the last slice stroke, pull the food chute all the way towards you. Turn the slicer off by pushing the stop button. The power indicator light will go out. Always turn slice thickness dial clockwise until it stops to close the slicer table.
7. Now you can unload and load food product from the food chute.

# Cleaning & Sanitizing

## ⚠️ WARNING



## SHARP KNIFE BLADE

TO AVOID SERIOUS PERSONAL INJURY TO SLICER OPERATOR AND CUSTOMERS:

- BEFORE CLEANING, SHARPENING, SERVICING OR REMOVING ANY PARTS, always turn slicer off, turn the slice thickness dial clockwise until it stops, and unplug the power cord.
- NEVER attempt to clean slicer with the knife running.
- NEVER attempt to remove the knife from slicer. It must remain on the slicer for proper operation, sharpening and cleaning.

## ⚠️ WARNING

To prevent illness or death caused by the spread of food-borne pathogens, it is important to properly clean and sanitize the entire slicer as surface of the slicer can become contaminated. It is the responsibility of the slicer owner/operator to follow all guidelines, instructions and laws as established by your local and state health departments and the manufacturers of chemical sanitizers.



Once the slicer makes contact with food product, the entire slicer, including removable parts, must be thoroughly cleaned and sanitized. This process is to be repeated at least every 4 hours using these procedures and information; and must comply with additional laws from your state and local health departments.



As with all food contact surfaces, it is extremely important to properly sanitize the entire slicer and to **closely follow the instructions on your quaternary sanitizer container to make sure proper sanitation is achieved to kill potentially harmful bacteria.**

**NOTE:** It can be desirable to wear non-cutting safety gloves during the cleaning operation.

**IMPORTANT:** If a chemical sanitizer other than chlorine, iodine or quaternary ammonium is used, it must be applied in accordance with the EPA-registered label use instructions. Excessive amounts of sanitizer and use of products not formulated for stainless steel or aluminum can VOID your warranty.

Sanitizer concentration must comply with section 4-501.114, Manual and Mechanical Warewashing Equipment, Chemical Sanitization - Temperature, pH, Concentration, and Hardness of the FDA Food Code.

For more information on proper kitchen and equipment sanitation, visit [www.servsafe.com](http://www.servsafe.com) provided by the National Restaurant Association (NRA).

## ⚠️ CAUTION

- **DO NOT** hose down, pressure wash, or pour water on slicer.
- **NEVER** use a scrubber pad, steel wool, or abrasive material to clean slicer.
- **ALWAYS** turn slicer OFF and unplug the power cord BEFORE cleaning.
- It is extremely important to follow the instructions on the sanitizer container to make sure proper sanitation is achieved. Allow the parts to air dry before placing them back on the slicer!

**DO NOT** use bleach, products containing sodium hypochlorite or other caustic/strong detergents on the slicer base or removable parts. These products will discolor and destroy the parts.

Slicer components are easily disassembled without the use of special tools. It can be desirable to wear non-cutting safety gloves during the cleaning operation.

# Cleaning & Sanitizing

## DISASSEMBLY & CLEANING

1. Turn slicer OFF.
2. Turn slice thickness dial clockwise past zero (0) until it stops so the table covers the knife edge.
3. Unplug the power cord.
4. Remove food chute's end weight. Hold end weight and unscrew slide rod (Fig. 11-1). Pull slide rod out of the pivot of end weight.
5. Remove the food chute. Loosen food chute release knob that fastens the food chute to chute arm (Fig. 11-2). Remove food chute from slicer.
6. Disassemble food chute. Use the knob on the back of the chute to unscrew food chute into three separate pieces (see photos below).

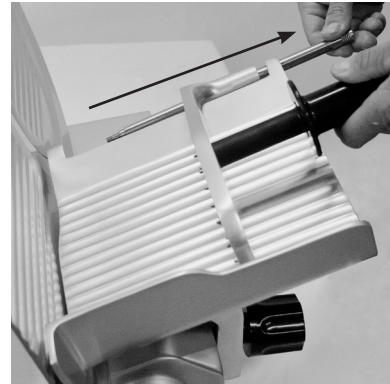

Figure 11-1

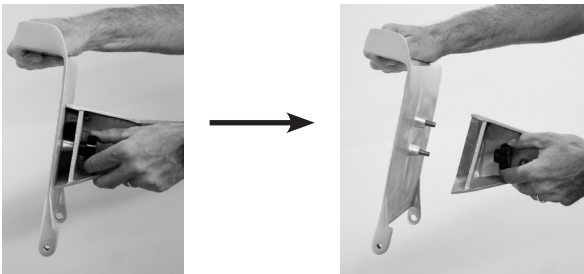

Figure 11-2

**!** **BE ALERT.** The next step will expose the knife.

7. Remove knife sharpener. Loosen screw on the neck of sharpener, then lift knife sharpener off and away from slicer (Fig. 11-3).
8. Remove knife cover by rotating knife cover release knob counterclockwise until it releases (Fig. 11-4), while carefully holding the edge of the knife cover and lifting the knife cover upward to remove.

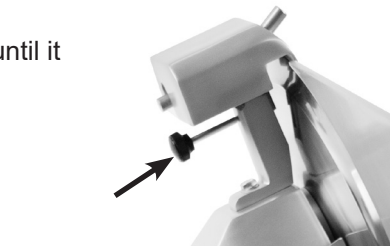

Figure 11-3

**!** **NOTE:** **NEVER** operate slicer with knife cover removed.

**!** **BE ALERT.** Slicer knife edge is exposed. Always be aware of the placement of your hands/fingers in relationship to the knife.

9. Remove slice deflector. Slice deflector can be removed by loosening the screw knobs (Fig. 11-4).

Place all removable parts in a three compartment sink with warm water and a mild detergent solution; soak, clean and thoroughly scrub all surfaces using a solution of mild detergent and warm water.

Removable parts include: food chute and all of its parts, end weight, slide rod, knife cover, knife sharpener, and slice deflector.

Rinse removable parts with fresh, clean water. Following the instructions on your quaternary sanitizer label, soak food chute and all of its parts, knife cover, knife sharpener and slice deflector in a proper solution of quaternary sanitizer for a minimum of two minutes. Allow these parts to air dry.



Figure 11-4

**An important step to kill bacteria is to allow the parts to air dry before reinstalling!**

# Cleaning & Sanitizing



**BE ALERT.** Slicer knife is fully exposed. Always be aware of the placement of your hands/fingers in relationship to the knife.

10. Knife must also be cleaned and sanitized. **Carefully** wash and rinse the top and bottom of knife by wiping from the **center of knife outward** (Fig. 12-1). Spray both sides of knife, slicer table and the entire slicer base with a non-bleach, non-chlorine sanitizer following the instructions on your quaternary sanitizer container to make sure proper sanitation is achieved. Allow slicer parts to air dry.

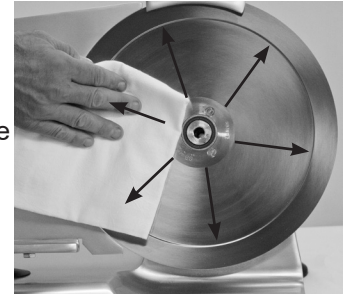

Figure 12-1

**An important step to kill bacteria is to allow the parts to air dry before reassembly!**



**DO NOT** allow moisture to get into knife hub.

Before reattaching slicer parts, the entire slicer must be fully cleaned, sanitized and left to air dry.

11. Soak a clean cloth in a mild detergent and warm water solution. Ring out excess water from cloth. With slicer table completely closed, wipe slicer table off by starting at knife and pulling towards you. Never wipe slicer table towards the knife. Spray or wipe a sanitizer on slicer table and allow it to air dry.
12. With a clean cloth soaked in mild detergent, wipe down all remaining surfaces of slicer to remove food, debris and grease/oil. Use a nylon brush to scrub difficult areas. Use a clean, wet cloth to rinse the entire slicer. Finish by spraying sanitizer on all surfaces and then let air dry.

## **REINSTALL REMOVABLE PARTS**

After cleaning, sanitizing, and allowing the parts to air dry, they must be reinstalled.



**BE ALERT.** Slicer knife is exposed. Always be aware of the placement of your hands/fingers in relationship to the knife.

1. **Carefully** reinstall slice deflector.
2. Reinstall knife cover. Put knife cover over knife, centering it on knife hub. Then, while holding knife cover in place with one hand, begin turning knife cover release knob clockwise with your other hand until knife cover is secured into place.



Figure 12-2



**NOTE: NEVER** operate the slicer with the knife cover removed.

3. Reinstall knife sharpener. Attach it to the top of the slicer and secure it with the knife sharpener release knob (Fig 12-3).



**NOTE: DO NOT** use sharpener with wet stones.



**IMPORTANT:** Before operating slicer, knife sharpener must be in place and secure.



Figure 12-3

# Cleaning & Sanitizing

4. Reassemble the food chute. (Fig- 13-1).
5. Put the cleaned and sanitized food chute back onto the slicer. Securely tighten food chute release knob to prevent “play” between food chute and chute arm (Fig. 13-2).
6. Reinstall end weight. Align end weight with chute and insert slide rod through chute and end weight (Fig 13-3). Allow end weight to rest on chute and securely screw in slide rod to slicer chute.
7. Plug in the power cord.

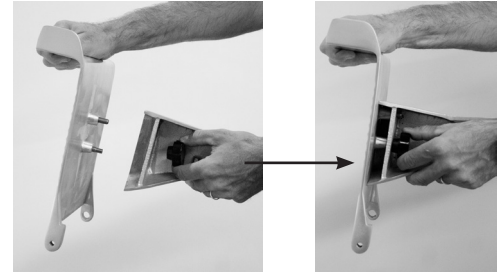

Figure 13-1

## **INSPECTION**

INSPECTING THE SLICER FOR DAMAGED OR BROKEN PARTS INCLUDING GASKETS & SEALS. A thorough visual inspection must be made of the entire slicer and its parts. Globe urges the owner/operator to inspect all components often and for an authorized service agent to inspect the entire slicer at least every 6 months, including all parts that are detachable for cleaning and sanitizing. This inspection must include: looking for damaged parts, broken seals or gaskets, and areas that can be more difficult to clean and sanitize.

## **WARNING**

IF A SEAL OR GASKET IS FOUND TO NOT PROPERLY SEAL, IS DAMAGED, OR IS MISSING, THE SLICER MUST BE REMOVED FROM SERVICE UNTIL IT IS REPAIRED BY AN AUTHORIZED SERVICER.



Figure 13-2

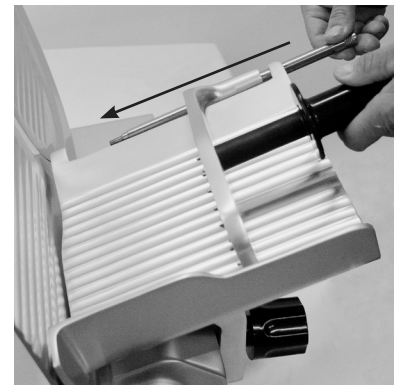

Figure 13-3

# Knife Sharpening

**WARNING**



## SHARP KNIFE BLADE

### TO AVOID SERIOUS PERSONAL INJURY:

- **NEVER** touch rotating knife.
- **ALWAYS** keep hands clear of all moving parts.
- **ALWAYS** turn slicer OFF, turn slice thickness dial clockwise until it stops, and remove food chute before sharpening.
- **NEVER** sharpen slicer unless all guards are installed.
- **NEVER** operate slicer without knife sharpener.

### WHEN AND HOW OFTEN TO SHARPEN THE KNIFE

1. Symptoms of a dull knife are excess waste (or “tail”) on the unsliced portion remaining in the food chute.
2. Knife should be sharpened periodically to provide consistent slices and maximum food product yield. Sharpening knife lightly every few days is more effective than heavy sharpening at less frequent intervals.

### PREPARING TO SHARPEN



**Make sure knife cover is in place and secure before sharpening.**

1. Turn off and unplug slicer. Turn slice thickness dial clockwise until it stops so slicer table covers knife's edge.
2. Remove food chute from slicer.
3. Clean and dry both sides of knife before sharpening, following instructions for knife cleaning on pages 11 through 13.



**NOTE:** The knife cover must be on during sharpening.

4. Loosen the sharpener release knob by turning it counterclockwise several times (Fig. 14-1).

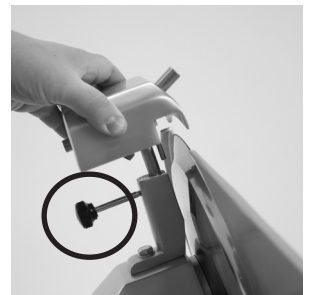

Figure 14-1



**BE ALERT. The next step will expose the knife.**

5. Lift the sharpener cover up (Fig. 14-1), rotate it clockwise and lower it into position with the knife fitting between the two stones (Fig. 14-2).
6. Tighten the sharpener release knob (Fig. 14-1) to secure the sharpener.



Figure 14-2

# Knife Sharpening

## SHARPENING THE KNIFE - (Regular Procedure)

1. Plug in and select the start button on the slicer.
2. Push grinding stone button #1 (Fig. 15-1) and honing stone button #2 at the same time so both stones make contact with knife. Maintain pressure on the buttons for 5-10 seconds.

 **TURN SLICER OFF** before inspecting.

## SHARPENING THE KNIFE - (Extended Procedure)

**NOTE:** Use the extended procedure if the regular sharpening procedure does not produce satisfactory results.

1. Start slicer.
2. Push grinding stone button #1 (Fig. 15-1) so the stone sharpens the back side of knife. Maintain pressure on the button for 30 seconds.
3. Push grinding stone button #1 (Fig. 15-1) and honing stone button #2 at the same time so both stones make contact with knife. Maintain pressure on the buttons for 5 seconds.

 **TURN SLICER OFF** before inspecting.

## AFTER SHARPENING

1. Turn slicer OFF and unplug the power cord.
2. Loosen sharpener release knob.
3. Rotate sharpener and place it back in its stored position.
4. Tighten sharpener release knob (Fig. 15-2).
5. **Clean and sanitize** the entire slicer as described on pages 10-13.
6. Reinstall food chute and plug the power cord in.

 **IMPORTANT:** Before operating the slicer, the knife sharpener must be securely in place.

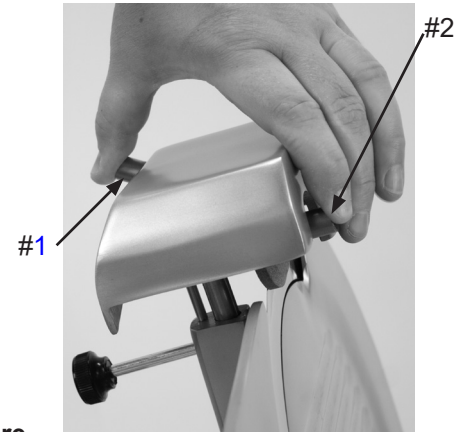

Figure 15-1



Figure 15-2

# Inspections, Simple Maintenance, and Repair

**WARNING**



## SHARP KNIFE BLADE TO AVOID SERIOUS PERSONAL INJURY:

- **BEFORE CLEANING, SHARPENING, SERVICING, OR REMOVING ANY PARTS**, always turn off and unplug slicer, turn the slice thickness dial clockwise past zero “0” until it stops, and remove the food chute.
- **NEVER TOUCH KNIFE.** Keep hands and arms away from all moving parts.
- **DO NOT** tamper with, bypass, or remove any safety devices, guards, START/STOP button, or touch pad controls.
- **AFTER EACH USE, ALWAYS** turn slicer OFF and turn the slice thickness dial clockwise past zero “0” until it stops.
- **USE ONLY** properly installed Globe parts and accessories

### INSPECTING THE SLICER

INSPECTING THE SLICER FOR DAMAGED OR BROKEN PARTS INCLUDING GASKETS & SEALS. A thorough visual inspection should be made of the entire slicer and its parts. Globe urges the owner/operator to inspect all components often and for an authorized service agent to inspect the entire slicer at least every 6 months, including all parts that are detachable for cleaning and sanitizing. This inspection must include looking for damaged parts, broken seals or gaskets, and areas that can be more difficult to clean and sanitize.

**WARNING**

IF A SEAL OR GASKET IS FOUND TO NOT PROPERLY SEAL, IS DAMAGED, OR IS MISSING, THE SLICER MUST BE REMOVED FROM SERVICE UNTIL IT IS REPAIRED BY AN AUTHORIZED SERVICER.

### SLICER INSPECTION

Slicer Seals and Gaskets Identified



# Inspections, Simple Maintenance, and Repair

## LUBRICATION

Various slicer parts need to be lubricated periodically using Globe oil. Globe oil is a light, tasteless, odorless mineral oil that will not contaminate or impart odors or taste to sliced food products.



**DO NOT USE VEGETABLE OIL TO LUBRICATE SLICER.  
VEGETABLE OIL WILL DAMAGE THE SLICER!**

### Food Chute Slide Rod

It is necessary to lubricate the food chute slide rod with Globe oil if the food chute becomes difficult to push.

1. Make sure slicer is off and unplugged. Then remove food chute.
2. Tilt slicer on its end.
3. Put several drops of Globe oil on slide rod (Fig. 17-1) towards the top of slide rod.
4. Tilt slicer back to its normal position.
5. Push food chute back and forth several times to distribute the oil onto slide rod.
6. Reinstall food chute.
7. Plug slicer in.

Slide Rod

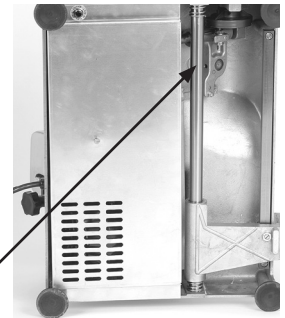

Figure 17-1

### Sharpener Shafts

It is necessary to lubricate the sharpener shafts with Globe oil every week.

1. Loosen sharpener release knob and pull sharpener up to remove it (Fig. 17-2).
2. Put several drops of Globe oil on shaft behind each sharpening stone (Fig 17-3).
3. Push both sharpener buttons a couple of times to distribute the oil onto the shafts.
4. Put several drops of Globe oil on main shaft (Fig. 17-2), place sharpener back into position and tighten sharpener release knob.
5. Wipe off any excess oil that drips onto slicer.

Main Shaft

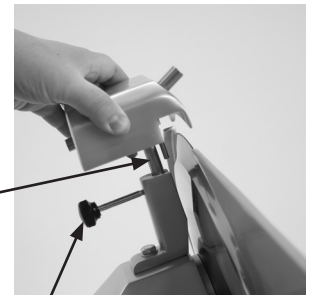

Figure 17-2

Sharpener Release Knob

**NOTE:** Sharpener and stones can be cleaned with warm water and a brush. Allow it to air dry. **If sharpener or stones are cleaned, it is very important that all sharpener shafts are lubricated with Globe oil afterwards!**

### End Weight Slide Rod

The end weight slide rod should be lubricated with a few drops of Globe oil, every week or when excessive drag is felt.

1. Apply a few drops of Globe oil to slide rod (Fig. 17-4).
2. Slide end weight up and down to distribute the oil.

Shafts

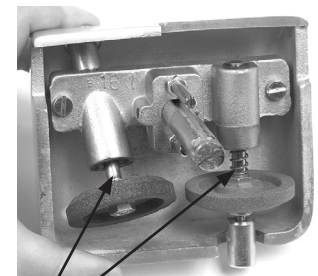

Figure 17-3

End Weight Slide Rod



Figure 17-4

# Troubleshooting Guide

PROBLEM	CAUSE	SOLUTION
Slicer will not start	Slicer not plugged in	Plug in slicer
	Motor reset button tripped	Press reset button located underneath slicer.
Ragged cuts-poor yield	Dull knife	Sharpen knife. Make sure knife and stones are clean.
	Chipped knife	Sharpen or have new knife installed
	Knife-slicer table gap too wide	Call for service to adjust slicer table.
	Knife too small	Have new knife installed.
Metal rubbing knife	Knife cover	Tighten knife cover release knob.
	Food chute	Tighten or adjust food chute knob.
	End weight	Have defective end weight replaced.
	Slicer table	Call for service to adjust slicer table.
Hard to push food chute	No lubrication	Lubricate slide rods thoroughly with Globe oil. <b>Do not use vegetable oil!</b>
Hard to sharpen	Stones dirty, wet or clogged with grease	Clean stones with warm water and a brush. Allow stones to air dry. Lubricate shafts with Globe oil afterwards.
	Knife dirty	Clean top and bottom of knife.
	Worn stones	Have stones replaced.
	Stones not properly aligned	Have sharpener adjusted.
Slicer stops running	Motor overheated	Wait 10-15 minutes for slicer to cool down. Push reset button, then start slicer.

If problem persists and the above solution does not remedy the issue, please call Globe's Service Department at 866-260-0522.

