

Parts Catalog



GIB750-20

Immersion Blender

Model: GIB750-20

06/18/2025 Rev. A

IMPORTANT!

TO EXPEDITE SHIPMENT OF PARTS, ALWAYS SPECIFY MODEL, REV,
PART NUMBER, AND SERIAL NUMBER OF UNIT.

GLOBE FOOD EQUIPMENT COMPANY

2215 East River Road
Dayton, Ohio 45439

Parts Department

Toll Free 1-800-745-6238 · Fax (937) 290-0585

E-Mail: info@globefoodequip.com

Website: www.globefoodequip.com

Not for resale

Table of Contents

Description

Page

GIB750-20 Blender Components

4

GIB750-20 Blender Tube Components

6



GIB750-20 Blender Components

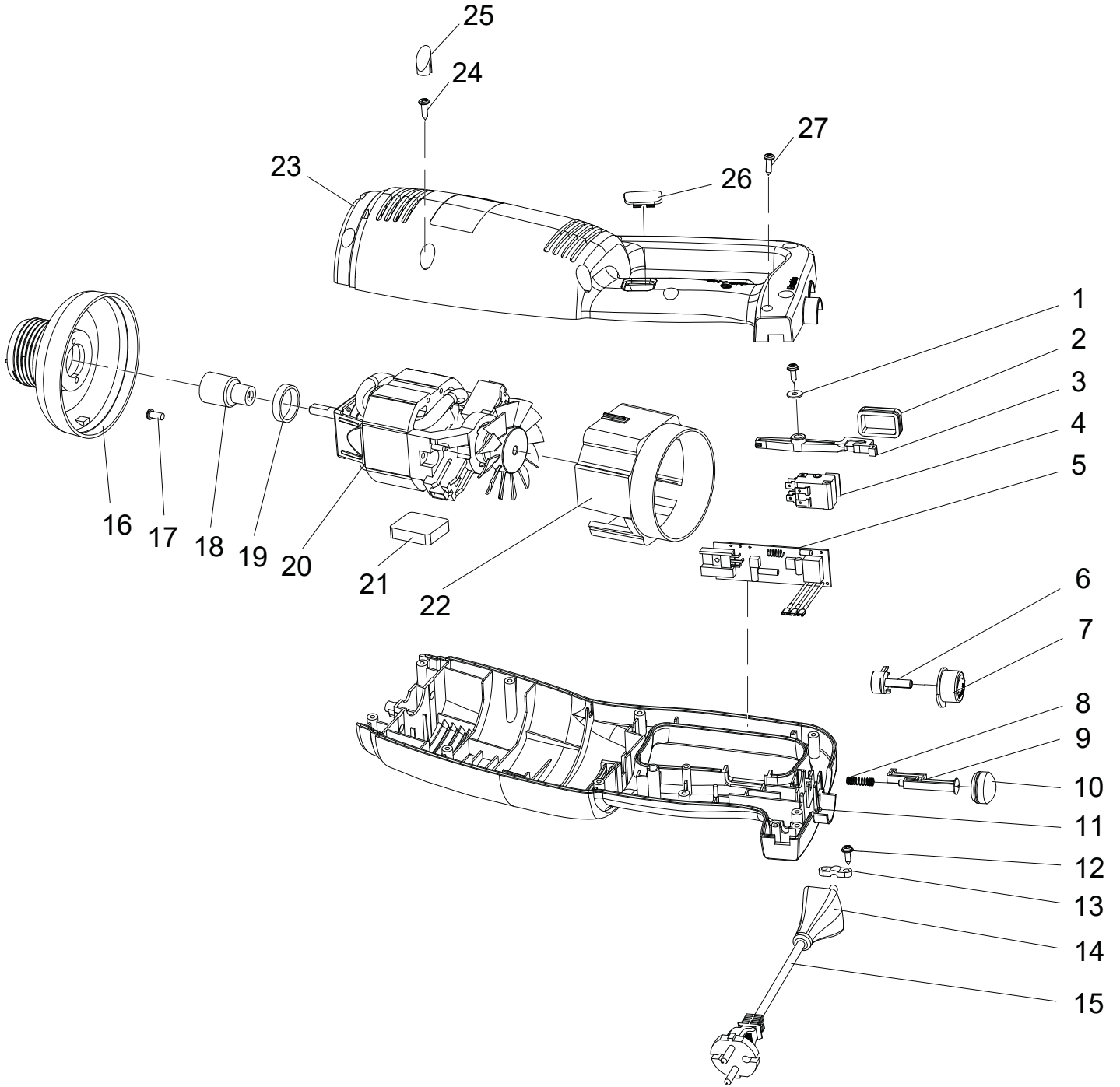



GIB750-20 Blender Components

Item	Part Number	Description	Qty	Serial Number
1	H02300	Screw, Washer Phillips Button Hd	1	
2	L02223	Button, ON-OFF	1	
3	L02214	Button, Osculant Staff	1	
4	L02215	Microswitch	1	
5	L02226	Control Board, Speed	1	
6	L02234	Potentiometer	1	
7	L02222	Knob, VARIABLE Speed	1	
8	L02216	Spring	1	
9	L02217	Bolt, Push	1	
10	L02221	Button, ENABLE	1	
11	L02228	Housing, Right	1	
12	H02301	Screw 4mmx15mm, Phillips Drive	2	
13	L02286	Tie Down	1	
14	L02218	Strain Relief	1	
15	L02219	Power Cord	1	
16	L02227	Coupling	1	
17	H02299	Screw M5-.8x10mm, Phillips Pan Hd	4	
18	L02207	Drive Hub	1	
19	L02233	Seal, Rubber	1	
20	L02230	Motor	1	
21	L02231	Gasket, Motor	2	
22	L02232	Cover, Motor	1	
23	L02229	Housing, Left	1	
24	H02298	Screw 3.9x15.5x.22mm Button PHH, Zinc	11	
25	L02292	Screw Cover Kit	1	
26	L02205	Cover	1	
27	H02297	Screw M3x15mm Phillips Zinc	1	
28	L02284	Warning Label	1	
29	L02285	French Warning Label	1	



GIB750-20 Blender Tube Components

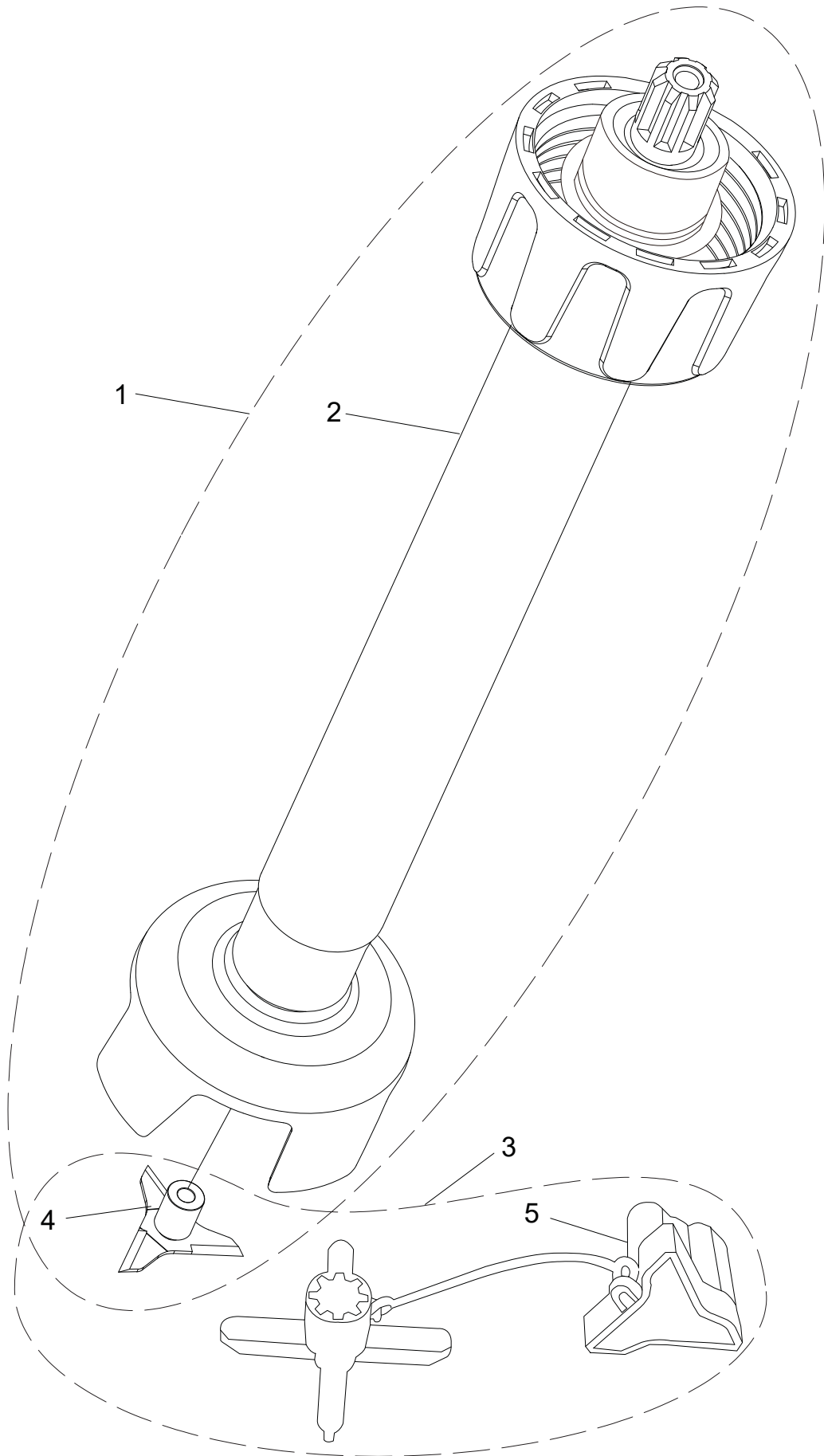



GIB750-20 Blender Tube Components

Item	Part Number	Description	Qty	Serial Number
1	L02331	20" Immersion Blender Tube Equivalent to GIBSTK20	1	
2		Blender Stick	1	
3	L02334	Blade Removal Kit Equivalent to GIB-BLADE TOOL	1	
4		Blade	1	
5		Blade Removal Tool	1	