



OPERATOR'S M A N U A L

OPEN FRYER (Electric)

MODEL

CFE-410

CFE-420



HENNY PENNY
Engineered to Last

REGISTER WARRANTY ONLINE AT WWW.HENNYPENNY.COM

TABLE OF CONTENTS

Section	Page
Section 1. INTRODUCTION	1-1
1-1 Introduction	1-1
1-2 Proper Care	1-1
1-3 Assistance	1-2
1-4 Safety	1-2
Section 2. INSTALLATION	2-1
2-1 Introduction	2-1
2-2 Unpacking	2-1
2-3 Selecting the Fryer Location	2-2
2-4 Leveling the Fryer	2-2
2-5 Ventilation of Fryer	2-3
2-6 Electrical Requirements	2-3
2-7 Dimensions	2-4
Section 3. OPERATION	3-1
3-1 Operating Components	3-1
3-2 Clock Set	3-5
3-3 Diagnostic Mode and Special Functions	3-7
3-4 Warnings and Error Messages	3-10
3-5 Filling and Adding Shortening	3-13
3-6 Filling Oil Reservoir	3-14
3-7 Basic Operations	3-15
3-8 Auto Top-Off	3-17
3-9 Care of Shortening	3-18
3-10 Quick Filter	3-19
3-11 Daily Filtering	3-21
3-12 Filter Menu	3-23
3-13 Discarding Oil from Vat Using Optional Discard Shuttle	3-24
3-14 Changing the Filter Envelope	3-26
3-15 Clean-Out Mode	3-29
3-16 Check/Replace Filter Drain Pan O-Rings	3-32
3-17 Manually Setting New or Used Shortening	3-33
3-18 Info Button Stats	3-34
3-19 Preventive Maintenance Schedule	3-34
Section 4. INFORMATION MODE	4-1
4-1. Information Mode Details	4-1
Section 5. TROUBLESHOOTING	5-1
5-1. Introduction	5-1
5-2. Troubleshooting	5-1
5-3. Troubleshooting Guide	5-2
5-4. Diagnostic Mode Details	5-9

SECTION 1. INTRODUCTION

1-1. INTRODUCTION

The Henny Penny open fryer is a basic unit of food processing equipment designed to cook foods better and easier. The micro computer-based design helps make this possible. This unit is used only in institutional and commercial food service operations, and operated by qualified personnel.

The Chick-fil-A controls for the Henny Penny Models CFE-410 and CFE-420 have many features to allow the Operator to produce consistent, quality product. The controls monitor not only cooking times and temperatures, but also shortening condition, product weights, product temperatures, and many other operational variables. The controls may vary the actual shortening temperature and cook times, based on changes of the operational variables.

The controls also have very extensive self-diagnostic functions which alert the Operator to both component and procedure problems.

Some unique features of the fryer are listed below:

- **Diagnostic Function**-provides summary of fryer and Operator performance; see Diagnostic Mode and Special Functions Section
- **Alarms and Error Messages**-provide immediate feedback for Operator error or fryer malfunction; see Warnings and Error Messages Section
- **Status Mode**-allows the Operator to view basic fryer information and status; see Diagnostic Mode and Special Functions Section
- **Information Mode**-gathers and stores historic information on the fryer and Operator performance, and can be viewed by the Operator; see Diagnostic Mode and Special Functions Section
- **Manual Program Mode**-Operator can set time and temperature for nonstandard products; see Diagnostic Mode and Special Functions Section
- **Easy toggle between English and Spanish operation.** See Diagnostic Mode and Special Functions Section
- **Clean-Out Mode**-a preprogrammed function for cleaning the frypot; see Cleaning the Frypot Section

1-2. PROPER CARE

As in any unit of food service equipment, the Henny Penny Open Fryer requires care and maintenance, both of which are covered in this manual. These must become a regular part of the operation of the unit at all times.

1-3. ASSISTANCE

Should you require outside assistance, call your local independent distributor in your area, or call Henny Penny Corp. at 1-800-417-8405 or 1-937-456-8405.

1-4. SAFETY

The Henny Penny open fryer has many safety features incorporated. However, the only way to ensure a safe operation is to fully understand the proper installation, operation, and maintenance procedures. The instructions in this manual have been prepared to aid you in learning the proper procedures.

This appliance is not intended for use by persons (including children) with reduced physical, sensory, or mental capabilities, or lack of experience and knowledge, unless they have been given supervision or instruction concerning use of the appliance by a person responsible for their safety.

Where information is of particular importance or safety related, the words DANGER, WARNING, CAUTION, and NOTICE are used. Their usage is described below.



SAFETY ALERT SYMBOL is used with DANGER, WARNING, or CAUTION which indicates a personal injury type hazard.



NOTICE is used to highlight especially important information.



CAUTION used without the safety alert symbol indicates a potentially hazardous situation which, if not avoided, may result in property damage.



CAUTION used with the safety alert symbol indicates a potentially hazardous situation which, if not avoided, may result in minor or moderate injury.



WARNING indicates a potentially hazardous situation which, if not avoided, could result in death or serious injury.



DANGER INDICATES AN IMMINENTLY HAZARDOUS SITUATION WHICH, IF NOT AVOIDED, WILL RESULT IN DEATH OR SERIOUS INJURY.

1-4. SAFETY (Continued)



Equipotential Ground Symbol

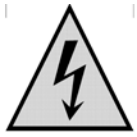

OR



Shock Hazard Symbols



OR



Hot Surface Symbols

SECTION 2. INSTALLATION

2-1. INTRODUCTION

This section provides the installation and unpacking instructions for the Henny Penny Evolution Elite® fryer.

NOTICE

Installation of this unit should be performed only by a qualified service technician.



Do not puncture the fryer with any objects such as drills or screws as component damage or electrical shock could result.

2-2. UNPACKING

NOTICE

Any shipping damage should be noted in the presence of the delivery agent and signed prior to his or her departure.

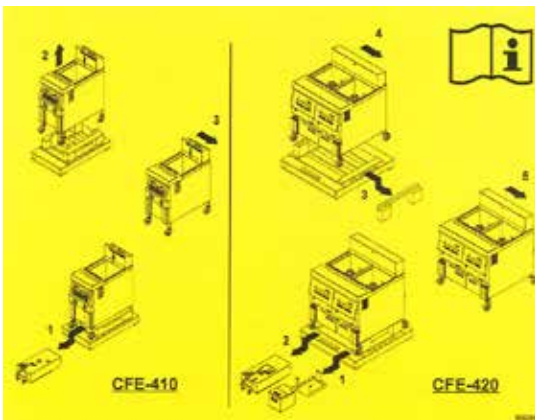

1. Cut and remove the metal bands from the carton.
2. Remove carton lid and lift the main carton off the fryer.
3. Remove corner packing supports (4).
4. Cut the stretch film from around the carrier/rack box and remove it from the top of the fryer lid.
5. Cut and remove the metal bands holding the fryer to the pallet, and remove fryer from pallet.

CAUTION

Remove filter drain pan and JIB shelf from fryer before removing fryer from pallet or damage to the unit could result. Figure 1.



Take care when moving the fryer to prevent personal injury. The CFE-410 weighs about 280 lbs. and the CFE-420 about 400 lbs.

2-3. SELECTING THE FRYER LOCATION

The proper location of the fryer is very important for operation, speed, and convenience. The location of the open fryer should allow clearances for servicing and proper operation. Choose a location which will provide easy loading and unloading without interfering with the final assembly of food orders. Operators have found that frying from raw to finish, and holding the product in warmers provides fast continuous service. Keep in mind, the best efficiency will be obtained by a straight line operation, i.e. raw in one side and finished out the other side. Order assembly can be moved away with only a slight loss of efficiency.

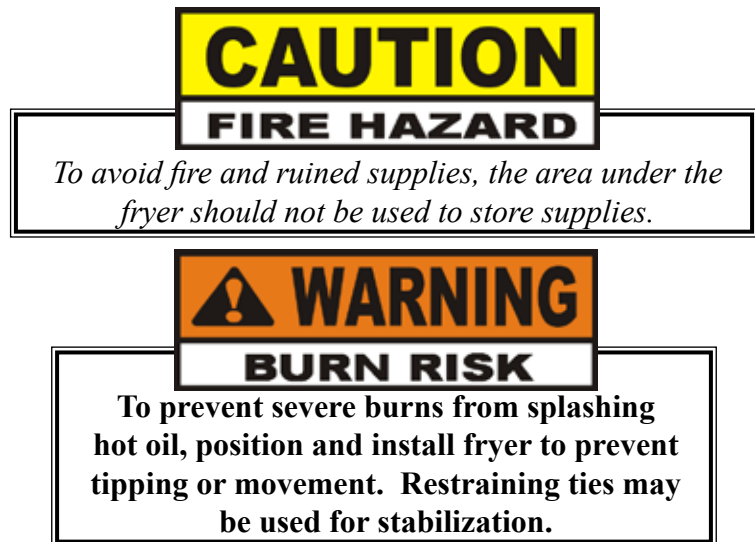

2-4. LEVELING THE FRYER

For proper operation, the open fryer should be level from side-to-side and front to back. Using a level placed on the flat areas around the vat collar, on the middle well, and then adjust the casters until the unit is level.

2-5. VENTILATION OF FRYER

The fryer should be located with provision for venting into an adequate exhaust hood or ventilation system. This is essential to permit efficient removal of the steam exhaust and frying odors. Special precaution must be taken in designing an exhaust canopy to avoid interference with the operation of the fryer. We recommend you consult a local ventilation or heating company to help in designing an adequate system.

NOTICE

Ventilation must conform to local, state, and national codes. Consult your local fire department or building authorities.

2-6. ELECTRICAL REQUIREMENTS

Check the data plate, mounted on the inside of the doors, to determine the correct power supply.



To avoid electrical shock, do not disconnect the ground (earth) plug. This fryer must be adequately and safely grounded (earthed). Refer to local electrical codes for correct grounding (earthing) procedures or in absence of local codes, with The National Electrical Code, ANSI/NFPA No. 70-(the current edition). In Canada, all electrical connections are to be made in accordance with CSA C22.2, Canadian Electrical Code Part 1, and or local codes.

To avoid electrical shock, this appliance must be equipped with an external circuit breaker which will disconnect all ungrounded (unearthed) conductors. The main power switch on this appliance does not disconnect all line conductors.

(FOR EQUIPMENT WITH CE MARK ONLY!)
To prevent electric shock hazard, this appliance must be bonded to other appliances or touchable metal surfaces in close proximity to this appliance with an equipotential bonding conductor. This appliance is equipped with an equipotential lug for this purpose. The equipotential lug is marked with the following symbol.



2-6. ELECTRICAL REQUIREMENTS (Continued)

CABLE RESTRAINT

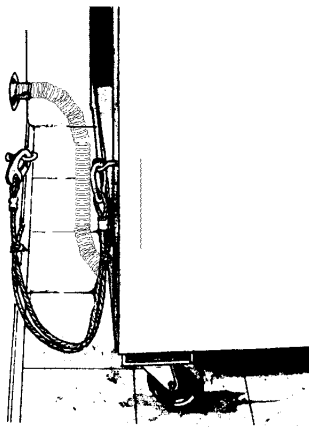

I-bolt is to be secured to the building using acceptable building construction practices.

CAUTION

DRYWALL CONSTRUCTION
Secure I-bolt to a building stud. Do not attach to drywall only. Preferred installation is approximately six inches to either side of service. Cable restraint must be at least six inches shorter than flexible conduit.

An all pole, separate disconnect switch, with proper capacity fuses or breakers must be installed at a convenient location between the fryer and the power source, and must be installed according to national and local codes. It should be an insulated copper conductor rated for 600 volts and 90° C. For runs longer than 50 feet (15.24 m), use the next larger wire size. CE units require a minimum wire size of 6 mm to be wired to the terminal block.

It is recommended that a 30 mA rated protective device such as a residual current circuit breaker (RCCB), or ground fault circuit interrupter (GFCI), be used on the fryer circuit.

Permanently connected electric fryers with casters must be installed with flexible conduit and a cable restraint, when installed in the United States. See illustration at left. Holes are available in the rear fryer frame for securing the cable restraint to the fryer. The cable restraint does not prevent the fryer from tipping.





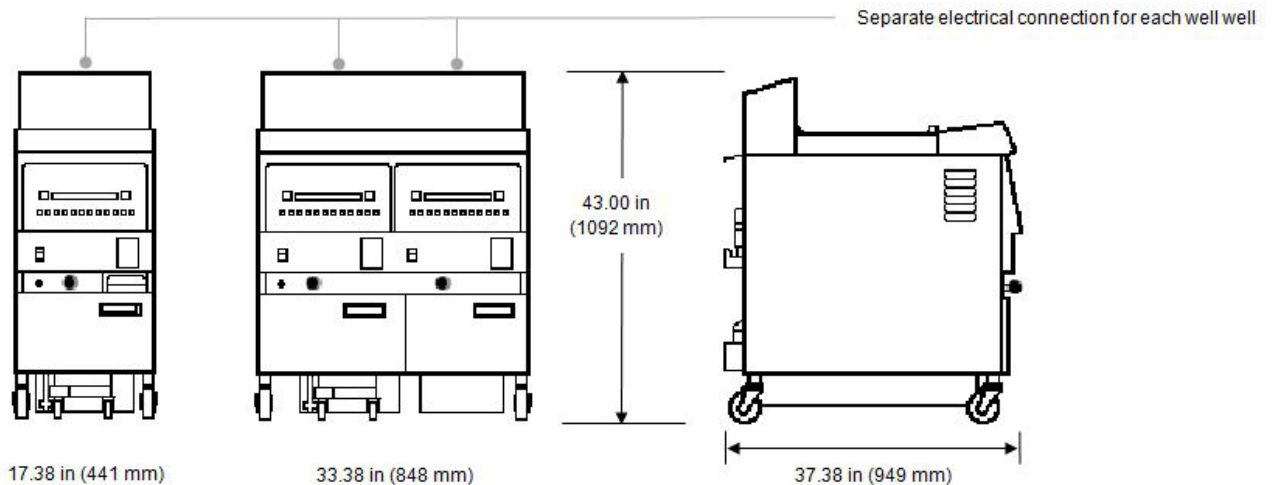







The supply power cords shall be oil-resistant, sheathed flexible cable, no lighter than ordinary polychloroprene or other equivalent synthetic elastomer-sheathed cord.

2-7. DIMENSIONS











3-1. OPERATING COMPONENTS
(Continued)

Refer to Figures 3-1, 3-2 & 3-3 in conjunction with the description of the functions below.

Fig. No.	Item No.	Description	Function
3-1	1	 HEAT ON	Lights when the control calls for heat and the shortening should start heating
3-1	2	Digital Display	Shows all the functions of the Cook Cycle, Program Mode, Diagnostic Mode and alarms
3-1	3	 WAIT	Flashes when the shortening temperature is not at the proper temperature for dropping product into the frypot
3-1	4	 READY	Lights when the shortening temperature is 5°F below setpoint to 15°F above setpoint, signaling product can now be cooked
3-1	5	 INFO	Press to display current fryer information and status; if pressed in the Program Mode, it shows previous settings; pressing this along with  accesses the Information Mode which has historic information on the Operator and fryer performance
3-1	6	 	Used to access the Filter Menu; also used for  or  buttons
3-1	7	 PROG	Press to access Program Mode; once in the Program Mode, it is used to advance to the next setting; if pressed along with  it accesses the Information Mode which has historic information on the Operator and fryer performance; it also allows access to the English-Spanish settings, diagnostics, Clean-Out Mode, and Manual Mode, if pressed before the appropriate button
3-1	8		Used to stop Cook Cycles and to stop the timer at the end of a Hold Cycle; it is also used to program a Manual Program for nonstandard products

3-1. OPERATING COMPONENTS

(Continued)

Fig. No.	Item No.	Description	Function
3-1	9	Menu Card	Shows name of food product selected; the menu card strip is located behind the decal
3-1	10	Product Select Button	Press to select food products to be cooked, as well as, answering display prompts; also,  accesses the diagnostics;  , the Clean-Out Mode; and  toggles between English and Spanish display (Press  before entering any of the above modes.)
3-1	11	Unit Identification Window	The unit's model number and the control's hardware and software version numbers appear here
3-2	12		A Filter Light is found beside each black drain knob; when lit blue  , indicates the oil should be filtered at this time;  beacon flashes when the drain needs opened or closed
3-3	13		When the power switch is turned to the ON position, power is supplied to the controls and pumps

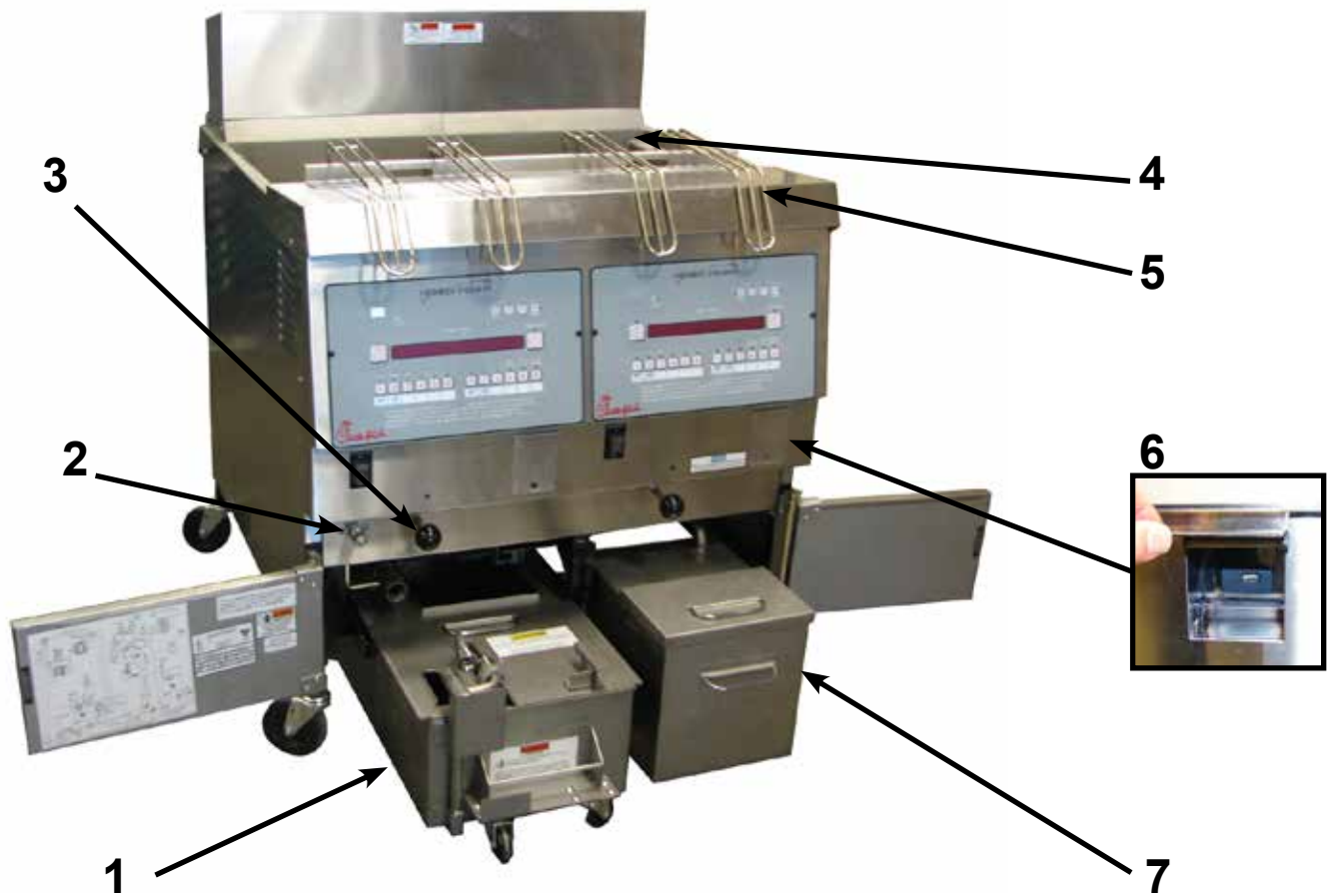



















Figure 3-4

Fig. No.	Item No.	Description	Function
3-4	1	Filter Drain Pan Assy.	Oil is drained into this pan and then is pumped through filters to help prolong the use of the oil
3-4	2	Quick Disconnect	Connection for oil disposal shuttle
3-4	3	Drain Valve Knob	Pull-out on black knobs to open drain valve and oil drains from vat; Push-in to close drain valve and oil can be pumped into vat
3-4	4	Vat Covers	Covers the vat when not in use
3-4	5	1/2 basket	Each frypot accommodates 2 baskets w/handles
3-4	6	USB Port	Used to download information from controls
3-4	7	JIB (Oil Reservoir)	Used to hold oil for the automatic oil top-off feature; should be filled once a day









3-2. CLOCK SET

NOTICE

Upon initial start-up or PC board replacement, if “**CLOCK SET**” automatically appears in the display, skip steps 1, 2 and 3.





1. Press and hold  for 5 seconds until “**LEVEL 2**” shows in display.
2. Release , then press  twice. “**CLOCK SET**” then “**ENTER CODE**” shows in display.
3. Press   .
4. Display shows “**CS-1**” then “**SET**” then “**MONTH**”, with the month flashing.
5. Press   to change the month.
6. Press . Display shows “**CS-2**” then “**SET**” then “**DATE**”, with the date flashing.
7. Press   to change the date.
8. Press . Display shows “**CS-3**” then “**SET**” then “**YEAR**”, with the year flashing.
9. Press   to change the year.
10. Press . Display shows “**CS-4**” then “**SET**” then “**HOUR**”, with the hour and “**AM**” or “**PM**” flashing.
11. Press   to change the hour and AM/PM setting.
12. Press . Display shows “**CS-5**” then “**SET**” then “**MINUTE**”, with the minutes flashing.

3-2. CLOCK SET
(Continued)

13. Press   to change the minutes.
14. Press . Display shows “CS-6” then “CLOCK MODE”, along with “1.AM/PM”.
15. “1.AM/PM” is 12 hour time, “2.24-HR” is 24 hour time. Press   to change.
16. Press . Display shows “CS-7” then “DAYLIGHT SAVINGS ADJ”, along with “2.US”.
17. Press   to change to the following:
- “1.OFF” = No automatic adjustments for Daylight Savings Time.
 - “2.US” = Automatically applies United States Daylight Savings Time adjustment. DST activated on the first Sunday in April. DST de-activated on the last Sunday in October.
 - “3.EURO” = Automatically applies European (CE) Daylight Savings Time adjustment. DST activated on the last Sunday in March. DST de-activated on the last Sunday in October.
18. Clock Set is now complete. Press and hold  to exit.



**3-3. DIAGNOSTIC MODE
AND SPECIAL
FUNCTIONS**

Diagnostic Mode

To view summaries of the fryer and Operator performance, press  then . Press   to view the following functions:

- D1 - Adjust product color for all products (not individually)
- D2 - The age of the shortening and life remaining
- D3 - Outlet voltage monitoring
- D4 - Fryer's heating performance
- D5 - Slow or oversized product batches
- D6 - Cook Cycles started before temperature recovered
- D7 - Cook Cycles stopped more than 10 seconds before end of cycle
- D8 - Cook Cycles not ended within 20 seconds after expired time
- D9 - Number of times loading product took too long
- D10 - Programmed variables changed by Operator



NOTICE

On several of the screens you may have to press  or  to respond to questions asked.

Press  at any time to exit and return to normal operation.

See Diagnostic Mode Details Section for more details of the Diagnostic Mode.











Language Selection

Pressing  then  allows the Operator to choose to display the information in English or Spanish.

3-3. DIAGNOSTIC MODE
AND SPECIAL
FUNCTIONS
(Continued)

Manual Mode

This allows the Operator to quickly program a time and press temperature for nonstandard products that are not on the menu card. This is to be a temporary setting and disables most of the advanced features of the controls. To enter Manual Mode:

1. Once out of the Melt Cycle, press  then .
2. Use   to set cook time.
3. Press  and use   to set temperature.
4. Press  to start Manual Mode. Display shows “MANUAL” and you start a Cook Cycle by pressing .
5. Press  to exit Manual Mode.

Status Mode

Pressing  during idle time, allows Operator to view:

- INFO**
- a. The temperature of the shortening
 - b. The temperature setpoint and any offset
 - c. The average shortening temperature during last Cook Cycle
 - d. The rate of temperature rise or fall
 - e. Date and Time





Pressing  during a Cook Cycle allows the Operator to view:

- INFO**
- a. The temperature of shortening, plus the degrees and rate the load compensation has affected the Cook Cycle (slows down or speeds up the timer)
 - b. The cooking step, the time left in Cook Cycle, and setpoint temperature
 - c. Average shortening temperature in Cook Cycle so far
 - d. The rate of temperature rise or fall
 - e. Date and Time

After 5 seconds, the control exits the Status Mode and the open fryer returns to normal operation.

3-3. DIAGNOSTIC MODE
AND SPECIAL
FUNCTIONS
(Continued)

Information Mode

This mode gathers and stores historic information on the fryer and Operator performance. Press  and  at the same time and **“*INFO MODE*”** shows on display. Press  or  to access the steps and press  to view the statistics within each step.

Information Mode is intended for technical use, but the Operator can view the following information:

1. E-LOG - last 10 errors and time they occurred
2. P-LOG - time of last 10 power-ups
3. HEAT-UPS - time of day and maximum heating rate (°/second) for the last 10 heat-ups
4. LEFT COOK DATA - information on the last Cook Cycle, using the left timer button
5. RIGHT COOK DATA - information on the last Cook Cycle, using the right timer button
6. TODAY'S DATA - data since the start of day (not including the last Cook Cycle)
7. PREV-DAY-SUN - creates a log of the last 7 days, using the information in TODAY'S DATA.
8. 7-DAY TOTALS-totals the information from the last 7days
9. OIL DATA - information on the current shortening, not including today's cooking information
10. PREV OIL DATA - information on last batch of shortening
11. INP - provides test of fryer inputs
12. OUTP - shows the state of heater
13. POT TMP - temperature of shortening
14. CPU TMP - temperature of PC board
15. ANALOG - status of controller's a-to-d converter
16. AC VOLTS - status of the line voltage to fryer
17. AMPS (Electric models only) - the present amp readings to heaters.



See Information Mode Details Section for more details.

3-4. WARNINGS AND ERROR MESSAGES

The controls monitor procedure problems and system failures with warnings and error codes. The display shows the warning or error code, and an alarm sounds.

Pressing  cancels most warnings and pressing any control button stops most error code alarms. But there are some exceptions (see below). The display shows the error until the situation is corrected.

WARNINGS

DISPLAY	CAUSE	CORRECTION
“W-1” “LOW VOLTAGE”	Incoming supply voltage too low	Have voltage at plug and receptacle checked•
W-2” “SLOW HEAT-UP	Faulty components or connections	Have elements, connections, and contactors checked
“W-3” “WAS NOT READY	Product loaded into frypot before  lights	Wait until shortening is at proper temperature before loading product
“W-4” “SLOW COOKING”	Too much product in frypot	Do not overfill frypot
“W-5” “SLOW COOKING”	Product loaded into frypot before  lights	Wait until shortening is at proper temperature before loading product
“W-6” “SLOW COOKING”	Faulty components or connections	Have elements, connections, and contactors checked
“W-7” “LOW AMPS”	Faulty components or connections	Have elements, connections, and contactors checked
“W-9” “DISCARD PRODUCT”	Product overcooked. (may appear after a “SLOW COOKING” warning	Discard product immediately
“OIL TOO HOT”	Didn’t allow shortening to drop to current product’s setpoint temperature	Cancel button stops this warning; once the shortening drops to setpoint temperature, the alarm automatically stops

**3-4. WARNINGS AND
ERROR MESSAGES
(Continued)**

In the event of a control system failure, the digital display shows an error message. The message codes are shown in the DISPLAY column below. A constant tone is heard when an error code is displayed, and to silence this tone, press any button.



ERROR CODES:

DISPLAY	CAUSE	CORRECTION
"E-1"	Low oil in frypot	Check oil level in JIB (oil reservoir)
"E-4" "CPU TOO HOT"	Control board overheating	Turn switch to OFF position, then turn switch back to ON; if display shows "E-4", the control board is getting too hot; check the louvers on each side of the unit for obstructions
"E-5" "FRYER TOO HOT"	Oil overheating	Turn switch to OFF position, then turn switch back to ON; if display shows "E-5", the heating circuits and temperature probe should be checked
"E-6A" "FRYER TEMP SENSOR"	Temperature probe open	Turn switch to OFF position, then turn switch back to ON; if display shows "E-6A", the temperature probe should be checked
"E-6B" "FRYER TEMP SENSOR"	Temperature probe shorted	Turn switch to OFF position, then turn switch back to ON; if display shows "E-6B", the temperature checked
"E-10" "HIGH LIMIT TRIPPED"	High limit	Allow heating elements to cool (15-20 minutes) and reset high limit by pressing down and releasing raised side of the switch for the vat that is not operating; switches are located just to the right of the drain knob; if high limit does not reset, high limit must be replaced 
"E-15" "DRAIN IS OPEN"	Drain switch	Make sure drain knob is completely pushed-in; if E-15 persists, have drain switch checked
"E-18" "LEVEL SENSOR FAILED"	Level sensor open	Turn switch to OFF position and then back to ON; if display still indicates a failed sensor, have the connections checked on the control board; have sensor checked & replaced if necessary
"E-19" "PROTECTION SENSOR FAILED"	Frypot protection sensor open	Turn switch to OFF position and then back to ON; if display still indicates a failed sensor, have the connections checked on the control board; have sensor checked & replaced if necessary

3-4. WARNINGS AND ERROR MESSAGES

(Continued)

ERROR CODES:

DISPLAY	CAUSE	CORRECTION
"E-25"	Wrong or faulty elements or wiring problem	Have electrical supply, wiring, and elements checked NOTICE Because of the seriousness of this error code, turn the POWER switch off and back on to cancel
"E-26" "HEAT AMPS ARE LOCKED ON"	Faulty contactors or PCB	Have the contactors and PC board checked NOTICE This error code could be displayed even with the POWER switch turned off. Unplug fryer or shut-off the wall circuit breaker to disconnect electrical power to fryer.
"E-41", "E-46"	Programming failure	Press power button to frypot off and back on again, if any of the error codes, have the controls re-initialized; if error code persists, have the control board replaced
"E-47"	<ul style="list-style-type: none"> Analog converter chip or 12 volt Amp sensor in backwards Faulty PCB 	<ul style="list-style-type: none"> Press power button to vat off and back on again, if "E-47" persists; if the  and  DO NOT light-up when the 8888's are displayed, have I/O board replaced Have positions of amp sensors checked Have control panel replaced
"E-48"	Input system error	Have PC board replaced
"E-60"	AIF PC board not communicating with control PC board	Press power button to turn vat off, wait 15 seconds, and turn back on again. If "E-60" persists, have connector between the PCB's checked; replace AIF PCB or control PCB board, if necessary
"E-70" "PWR SW OR WIRES FAILED"	Faulty POWER switch or switch wiring; faulty I/O board	Have POWER switch checked, along with its wiring; have I/O board checked
"E-92" "24 VOLT FUSE"	Blown 24 volt controller fuse, or bad 14-pin cable connection	Have the 14-pin cable connector or fryer checked for a short to ground in components such as the drain switch, or high limit and wiring

**3-5. FILLING OR
ADDING OIL**

CAUTION

The oil level must always be above the heater elements when fryer is heating and at the oil level indicators on the rear of vat. Failure to follow these instructions could result in a fire and/or damage to the fryer.

Solid oil is not recommended. Solid oil could cause clogging and pump failures.

WARNING
BURN RISK

Wear gloves to avoid severe burns when pouring hot oil into vat. Oil and all metal parts that are in contact with the oil are extremely hot; take care to avoid splashing.



Figure 1



Figure 2

1. It is recommended that a high quality frying oil be used in the open fryer. Some low grade oils have a high moisture content and cause foaming and boiling over.
2. **Oil Capacity: 65 lbs/vat**
All vats have 2 level indicator lines inscribed on the rear wall of the vat. The upper-most line shows the oil at the proper level when heated. Figure 1.
3. Place basket support inside of vat and fill vat with cold oil to the lower indicator. Figure 2.

3-6. FILLING OIL RESERVOIR



Figure 1

Fill Line

1. During morning start-up procedures, or when control displays “E-1” and an alarm sounds, fill the auto-fill oil reservoir.
2. Open door, pull reservoir forward and open reservoir cover.
3. Pour oil into reservoir up to fill lines and then close cover and push reservoir back into position. Figure 2.

NOTICE

The JIB (oil reservoir) for the 2-well fryer (model CFE-420) rests on a cradle behind the right door. See below. The reservoir can be filled like the single-well as shown in Figure 1.



Figure 2

Removing/Cleaning Reservoir

1. Open door and pull reservoir forward.
2. Lift-up on reservoir, disengaging the reservoir from the slotted key-way. Figure 2.
3. Clean reservoir at a sink with soap and water.

NOTICE



Before placing the reservoir back into position, lubricate the o-rings (below) on the filter tube with cold oil. Check o-rings for tears or nicks and replace if necessary. To replace o-ring, use a small, flat-bladed screwdriver, pry up on the o-ring and pull off of end of tube. See below.



Figure 3



3-7. BASIC OPERATIONS

1. Make sure basket support is in vat and vat is filled with oil to the proper level. See Section 3-5.
2. Fill the oil reservoir. See Section 3-6.
3. Turn the POWER switch to ON. Upon initial start-up “**CLOCK SET**” shows in display. Set the clock to your time, following prompts on the display, or see Section 3-2 for help. Then display asks if the shortening is “**NEW**” or “**OLD**”. The controls automatically adjust the shortening temperature to the age of the shortening. Use   to set the number of days of old shortening.



Unit automatically goes into the Melt Cycle until the oil temperature reaches 230°F (110°C), the controls go into the Heat Cycle and the shortening heats to a preset temperature.

NOTICE

Once melted shortening reaches the proper level in the vat, the Melt Cycle can be bypassed by pressing and holding one of the product buttons.

CAUTION

Do not leave fryer unattended and do not bypass the Melt Cycle unless enough oil has melted to completely cover all of the elements. If the Melt Cycle is bypassed before the elements are covered, excessive smoking of oil, or a fire will result.

4. Stir the shortening as it heats up from a cold start. Be sure to stir down into the bottom of the vat.
5. Once out of the Melt Cycle,  flashes until 5° before setpoint temperature (plus any offset temperature).  then lights and the selected product shows on display.

NOTICE

The heat cycles on and off about 4 degrees before the setpoint temperature to help prevent overshooting the setpoint temperature (proportional control).

6. If the shortening was not filtered the night before at shutdown, filter the shortening now. Refer to Filtering Instructions Section.

3-7. BASIC OPERATION
(Continued)



7. Follow the steps in Chick-fil-A's training materials to load the product.

NOTICE



Before loading product, make certain **READY**  is lit, indicating the shortening is at the correct cooking temperature for the type of product being cooked. The actual temperature may vary 20 degrees or more depending shortening age, product weights, product temperature, and other operational variables.

8. Press the desired product button to start a Cook Cycle (left or right side). The display counts down the cooking time on the side the product button was pressed.

NOTICE

To check the shortening temperature press **INFO** . To stop a Cook Cycle, press .

The cook times may vary, compensating for shortening age, product weights, product temperature, and other operational variables.

9. At the end of the Cook Cycle, an alarm sounds, and the display flashes **"DONE"**. Press  to stop the alarm.
10. Follow the steps in Chick-fil-A's training materials to unload the product and check for doneness.
11. Before frying next load, allow for the shortening to reheat and **READY** lights.









3-8. AUTO TOP-OFF

During normal operation, the control automatically monitors vat oil level. If the control senses oil level is too low, unit automatically pumps oil from JIB (oil reservoir) into vat to keep oil at proper level.

The JIB (oil reservoir) must be filled at least once a day, preferably in the mornings. This helps prevent an “E-1” error code. See Section 3-6

Manual Top-Off

If oil level is a little low, oil can be added to vat at any time from JIB (oil reservoir) to raise oil level to proper level by following steps below. This procedure is NOT to be used to fill an empty vat.

1. Press and hold  (either one-full vat) until display shows “*FILTER MENU*” followed by “1.EXPRESS FILTER”.
2. Press  5 times until “6.FILL FROM JIB” shows in display.
3. Press  button; “FILL” & “DONE” is displayed.
4. Press and hold left  button; display shows “FILLING” and oil is pumped from the oil reservoir to the vat.
5. Once vat is full, release  button; “FILL” & “DONE” displays. Press right  button and then  for normal operation.

**3-9. CARE OF THE
SHORTENING**

** DANGER
OVERFLOW RISK**

FOLLOW THE INSTRUCTIONS BELOW TO AVOID SHORTENING OVERFLOWING THE FRYPOT, WHICH COULD RESULT IN SERIOUS BURNS, PERSONAL INJURY, FIRE, AND/OR PROPERTY DAMAGE.

1. To protect the shortening when the fryer is not in immediate use, the fryer should be put into the Idle Mode.
2. Frying breaded products requires filtering to keep the shortening clean. Shortening should be skimmed frequently throughout the day and filtered thoroughly once a day. Refer Filtering Instructions Section.
3. Discard shortening if display shows “CHANGE OIL SOON” or if shortening shows signs of excessive foaming or smoking.
4. Maintain the shortening at the proper cooking level. Add fresh shortening as needed.
5. Do not overload the baskets with product, or place product with extreme moisture content into baskets.

** DANGER
FIRE HAZARD**

WITH PROLONGED USE, THE FLASHPOINT OF SHORTENING IS REDUCED. DISCARD SHORTENING IF IT SHOWS SIGNS OF EXCESSIVE SMOKING OR FOAMING. SERIOUS BURNS, PERSONAL INJURY, FIRE, AND/OR PROPERTY DAMAGE COULD RESULT.

3-10. QUICK FILTER





Figure 1



Figure 2



Figure 3

1. During normal operation and after 36 cook cycles, the Filter Light illuminates on the front of the fryer (Figure 1), and “FILTER LOCKOUT”/”YOU *MUST* FILTER NOW”, shows in the display. The control refuses further cook cycles until the vat is filtered.
2. **Check Filter Pan:** If the filter drain pan or cover is not in place, the display shows “CHK PAN”. Make sure that the filter pipe is tightly connected, and that the filter drain pan is as far back under fryer as it will go and the filter pan cover is in place.
3. Press  button and display shows *SKIM VAT* followed by “CONFIRM” “YES NO”. Skim vat, press  and display shows “OPEN DRAIN”. Pull drain knob (Figure 2) out, display shows “DRAINING” and oil drains from the vat.



To avoid overfilling the drain pan, drain only 1 vat at a time. The drain pan holds 1 vat of oil. Overfilling the drain pan may cause slippery floors which may result in personal injury.



If filtering is NOT desired, turn off power switch and the display shows “STOPPED” followed by “CONTINUE FILTER” “YES NO”. Press  button, display shows



“QUIT FILTER” “YES NO”, press  button; SmartFilter is cancelled, the blue light goes out, and controls return to normal operation. Controls will suggest filtering after several more cook cycles.

If the drain is clogged, the display shows “VAT EMPTY”, followed by “YES NO”. Use straight white brush to clear drain, press the  button, and display shows

“DRAINING”. Controls will proceed with filtering process.

4. At end of drain cycle, “VAT EMPTY” followed by “YES NO” is displayed. Visually check vat is empty and press  button, “WASHING” is displayed. Once filter process is complete, display shows “CLOSE DRAIN”. Push-in on drain knob to close drain (Figure 3). Display shows “FILLING” and vat re-fills with oil.

3-10. QUICK FILTER
(Continued)

5. Once vat is filled, display shows “IS POT FILLED?” “YES NO”. Make sure vat is full and then press  button and the control returns to normal operation.
6. If the oil has not pumped back to the proper level in the vat during the Quick Filter process, press  button and pump runs for another 30 seconds.

Then the display shows “IS POT FILLED?” “YES NO”. Make sure vat is full, press  button and the control returns to normal operation.

You can try to fill the vat 3 times.

Filter Error

8. After trying to fill the vat 3 times without success, the display shows “*CHANGE* *FILTER* *PAD* CLOGGED?”. Press  button and controls turn OFF.

Change filter envelope following procedures in Changing the Filter Envelope Section.

If filter envelope is not changed, the “CHANGE FILTER PAD?” reminder will display every 4 minutes until envelope is changed.

9. During the next Quick Filter with a new filter envelope, if the vat is not filled after 3 tries, the display shows “FILTER SERVICE REQUIRED-SEE TROUBLE-SHOOTING GUIDE” followed by “YES”. Press  button and controls turn unit OFF.

NOTICE

To help ensure vat fills completely, clean the filter pan at least once a day, change the filter envelope at least once a day, and make sure JIB (oil reservoir) is full and that “O” rings on the filter pan are in good condition. If your store operates 24 hours a day, clean the filter pan and change the filter envelope twice a day.

3-11. DAILY FILTERING

This filtering procedure allows for a more thorough cleaning of the vat and should be done once a day. The vat can be filtered during any non-frying times.



To avoid burns from hot oil, use approved safety equipment including, apron, face shield and gloves before starting filtering procedure.

Also, to avoid overfilling the drain pan, drain only 1 vat at a time. The drain pan holds 1 full vat of oil. Overfilling the drain pan may cause slippery floors, which may result in personal injury.



Figure 1

1. **Check Filter Pan:** A new filter envelope should be used on the first filter of each day, but the same filter envelope can be used the rest of the day.

Make sure that filter pan cover is in place, filter drain tube is secured, and filter drain pan is pushed into place. If filter drain pan and cover are not latched into place, the display shows “CHK PAN”.

2. Press and hold **F** until display shows “1.EXPRESS FILTER?”
3. Press **▽** button and display shows “2.DAILY FILTER?”
4. Press **1** button and display shows “CONFIRM”, followed by “YES NO”.
5. Press **1** button for YES; display shows “OPEN DRAIN”. Pull-out on the drain knob (Figure 1), the display shows “DRAINING” and the oil drains from the vat, **or** press **3** button and controls return to normal operation.
6. Once oil has drained from vat, remove basket support from vat. Figure 2.



Figure 2



Use protective cloth or gloves when lifting the basket support. Support may be hot and burns could result.

**3-11. DAILY FILTERING
(Continued)**



Figure 3



Figure 4

8. Scrape or brush the sides and the bottom of the vat. Be careful not to damage the sensing probes.

CAUTION

Do not use steel wool, other abrasive cleaners or cleaners/ sanitizers containing chlorine, bromine, iodine or ammonia chemicals, as these will deteriorate the stainless steel material and shorten the life of the unit.

Do not use a water jet (pressure sprayer) to clean the unit, or component damage could result.

9. Once the vat is clean and the display shows “SCRUB VAT COMPLETE?” “YES NO”. Press button and the display shows “WASH VAT” “YES NO”.
10. Press button, display shows “WASHING” and oil circulates through vat for several minutes. When wash cycle is complete, display shows “WASH AGAIN?” “YES NO”.
11. Press button if another wash is needed, otherwise press button and the display shows “CLOSE DRAIN”. Push-in on drain knob to close drain (Figure 3), the display shows “RINSING” and vat fills with oil.
12. Once the vat is filled, “OPEN DRAIN” shows in display. Pull-out on drain knob to open the drain (Figure 4) and display shows “RINSING”. When rinsing is complete, display shows “RINSE AGAIN?” “YES NO”.
13. Press button if another rinse is needed, otherwise press button. Display shows “POLISH?” “YES”.
14. Press button for YES and oil is “polished” by circulating it through the filtering system. The display shows “5:00 NO=STOP”. If desired, press button to stop the polishing, otherwise the oil is polished for 5 minutes.
15. Once the oil is polished, the display shows “FILL VAT?” “YES”. Press button and display shows “CLOSE DRAIN”. Push-in on drain knob to close drain (Figure 3), display shows “FILLING” and vat then re-fills with oil.



3-11. DAILY FILTERING
(Continued)

16. Once full, display shows “IS POT FILLED?” “YES NO”.

Press  button; fryer returns to normal operation.

If  button is pressed, display shows “FILLING”. You can try to fill vat 4 times and then control shows “ADD QUIT”.

Press left  button and JIB pump runs 60 seconds, filling vat

from oil reservoir. When vat is full, press right  button and display shows “IS POT FILLED? “YES NO”. Press  button and fryer returns to normal operation.

3-12. FILTER MENU

Along with Express Filter and Daily Filter, here is a listing of all the Filter Menu items available.

Press and hold  button;

1.EXPRESS FILTER

2.DAILY FILTER

3.DISPOSE

4.DRAIN TO PAN

5.FILL FROM PAN

6.FILL FROM JIB (oil reservoir)

7.EXIT

**3-13. DISCARDING OIL
FROM VAT USING
OPTIONAL OIL SHUTTLE**



Figure 1



Figure 2

NOTICE

“BULK OIL DISPOSE?” in the Special Program Mode or Set-Up Mode, must to set to “FRONT” for the Front Dispose System to operate.

1. Locate disposal shuttle and attach to fryer. Figures 1 & 2.
2. Press and hold **F** until display shows “*FILTER MENU*”, along with “1.EXPRESS FILTER?”.
3. Press and release **▽** button twice until display shows “3.DISPOSE?”. Press **1** button; display shows “DISPOSE?” “YES NO”.
4. Press **1** button; “DRAIN VAT? YES NO” shows in display.
Press **3** button if draining the vat is not desired and skip to step 9.
5. Press **1** button and Filter Light flashes & display shows “OPEN DRAIN”. Pull-out on blacke drain knob to open drain and display shows “DRAINING”. Figure 2.
6. Oil drains from vat into drain pan and then display shows “VAT EMTY” “YES NO”. Verify that vat is empty, and press **1** button.
7. Display shows “CLEAR OLD OIL FROM OIL LINES” “DISPOSE” “DONE”. Press and hold left **⌚** button for a few seconds to clear old oil. Once cleared, press right **⌚** button.
8. Display shows “CLN VAT COMPLETE” “YES NO”. Once vat is clean, press **1** button.

**3-13. DISCARDING OIL
FROM VAT USING
OPTIONAL OIL SHUTTLE
(Continued)**



9. Press  button and display shows “DISPOSE” “DONE”
Press & hold left  button and oil pumps into shuttle.

NOTICE

The dispose switch will not run the pump motor until this step in the Oil Dispose Mode.

**WARNING
BURN RISK**

Use care to prevent burns caused hot surfaces and by splashing of hot oil.

10. Once oil is no longer pumping from drain pan, press right  button. Blue Filter Light flashes and display shows “CLOSE DRAIN” and push-in the black drain knob to close drain.
11. Display shows “MANUAL FILL VAT”, followed by “IS POT FILLED?”, along with “YES NO”. Fill the vat to the lower indicator line on the rear of the vat. See Filling or Adding Oil instructions from Section 3-5.
- Press  button and fryer returns to normal operation.

3-14. CHANGING THE FILTER ENVELOPE

In order to assure good oil pumping performance, the filter envelope should be changed at least once per day. However, in stores open 24 hours a day, the envelope should be changed twice a day.

NOTICE

If filter envelope has not been changed, a reminder “CHANGE PAD” shows on the display. Press  button to cancel the message, but it reappears every 4 minutes until the filter envelope has been changed.



Figure 1



Figure 2



Figure 3



Figure 4

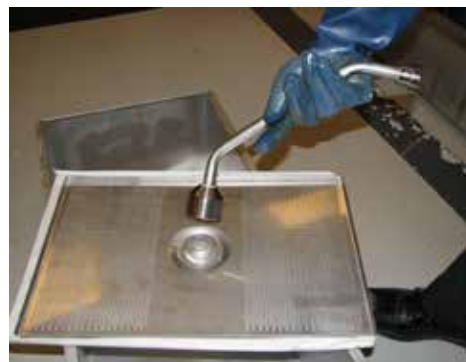

Figure 5

1. Make sure the main power switch is in the ON position.
2. Open the door, push down on the drain pan stop and pull-out the drain pan assembly, using the handle on the drain pan. Figures 1 & 2.

WARNING

BURN RISK

This pan could be hot! Use protective cloth or glove, or severe burns could result.

If the filter pan is moved while full of oil, use care to prevent splashing, or burns could result.

3. Lift the pan cover from the drain pan. Figure 3.
4. Unscrew the filter union nut from the standpipe. Figure 4.
5. Pull stand pipe and screens from drain pan, and unscrew standpipe assembly from the screens. Figure 5.

3-14. CHANGING THE FILTER ENVELOPE (Continued)

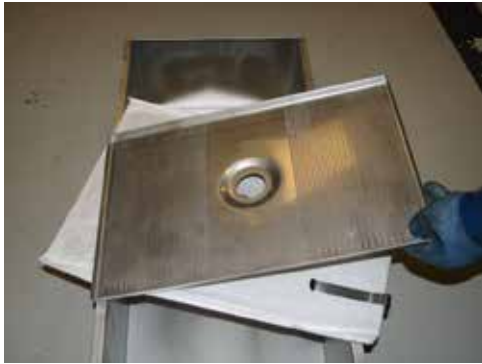

Figure 6



Figure 7



Figure 8

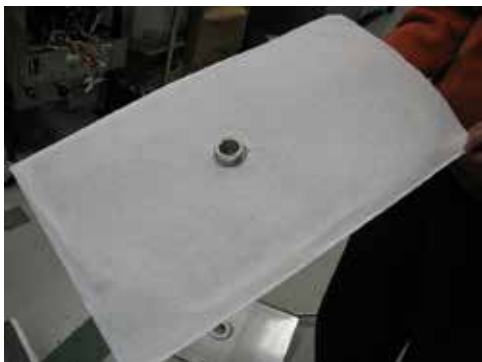

Figure 9

6. Lift the crumb catcher from the filter assembly, and wipe oil and crumbs from the crumb catcher. Clean the crumb catcher with soap and water, then thoroughly rinse with hot water. Figure 6.

7. Pull retaining clips from envelope, pull envelope from bottom screen and discard envelope. Figure 7.

Clean filter screen thoroughly with soap and water, and rinse thoroughly with hot water.

8. Wipe the oil and crumbs from the drain pan. Clean the drain pan with soap and water, then thoroughly rinse with hot water. Figure 8.

NOTICE

Be sure that drain pan, bottom screen, crumb catcher, and the retaining clips are thoroughly dry before placing filter envelope into pan as water dissolves the filter envelope.

9. Slide a new filter envelope over the bottom filter screen, aligning the hole in the envelope with the fitting on the bottom of the screen. Figure 8.

10. Fold the corners in and then double fold the open end. Secure with sealer bar. Figures 9 & 10.

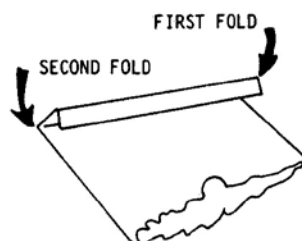
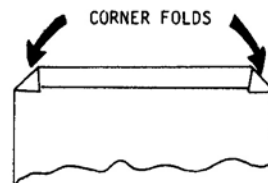

Figure 9



Figure 10

3-14. CHANGING THE FILTER ENVELOPE (Continued)

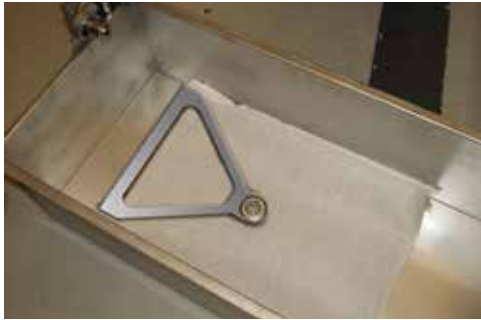

Figure 11

11. Place filter screen assembly into pan. Figure 11.



Figure 12

12. Place crumb catcher onto assembly with the threads in the center hole. Figure 12.



Figure 13

13. Hand tighten the standpipe onto the filter screen assembly. Figure 13.

14. After it is tight, align to the standpipe to the filter union on pan, and hand-tighten ONLY to prevent damage or over-tightening. Figure 14.



Figure 14

15. Place drain pan lid onto pan. Figure 15.



Figure 15

3-14. CHANGING THE FILTER ENVELOPE (Continued)



Figure 15

16. Push the filter pan assembly back underneath the fryer, making sure the filter tube on the pan makes a good connection with the fitting underneath the fryer. Figure 9.

Fryer is now ready for normal operation.



To avoid burns when pouring hot solution, wear gloves and protective gear and take care to avoid splashing.

3-15. CLEAN-OUT MODE



1. Turn the power switch to OFF.
2. Cover adjoining vats to avoid accidentally contaminating oil with fryer cleaning solution.



Do not cook product in adjoining vat when clean-out mode is in progress to avoid contaminating oil and/or product.

3. If hot shortening is present in the frypot, pull-out black drain knob and drain oil into drain pan. (Or, pump oil into disposal shuttle.) Refer to Section 3-13 for discarding oil.
4. After oil has been drained, close the drain by pushing in the black knob and proceed with normal oil discard procedure. An “E-15” will appear on the control display indicating the drain is open.
5. After allowing the drain pan to cool, remove the filter pan. Remove the filter screen and discard the old filter pad. Replace filter screen.
6. Place filter pan assembly back under unit



The filter drain pan must be as far back under fryer as it will go, and the cover in place. Be sure the filter drain pan is latched into place and the hole in the cover lines up with the drain before opening the drain.

Failure to follow these instructions causes splashing of shortening and could result in personal injury.

Moving the fryer or filter drain pan while containing hot shortening is not recommended. Hot shortening can splash out and severe burns could result.

Always wear chemical splash goggles or face shield and protective rubber gloves when cleaning the frypot as the cleaning solution is high in alkaline. Avoid splashing or other contact of the solution with your eyes or skins. Severe burns may result. Carefully read the instructions on the cleaner. If the solution comes in contact with your eyes rinse thoroughly with cool water and see a physician immediately.

Also, to avoid overfilling the drain pan, drain only 1 vat at a time. The drain pan holds 1 full vat of oil. Overfilling the drain pan may cause slippery floors which may result in personal injury.

3-15. CLEAN-OUT MODE
(Continued)

7. Follow the directions in Chick-fil-A's training materials and fill the frypot to the level indicator line with cleaning solution.



CAUTION



Do not scrape the electric fryer elements, or use scouring pads on elements. This produces scratches on the surface of the element causing breading to stick and burn.

Do not use steel wool, other abrasive cleaners, or cleaners/sanitizers containing chlorine, bromine, iodine, or ammonia chemicals as these will deteriorate the stainless steel material and shorten the life of the unit.

Do not use a water jet (pressure sprayer) to clean unit or component damage could result.



8. Turn the POWER switch to ON and immediately press **PROG** then . "CLEAN OUT ?" then "1=YES 3=NO" shows in display. Press  to start Clean-Out Mode.

The fryer displays "*CLEAN-OUT MODE*" and heats up to a pre-programmed temperature, then automatically begins a 15-minute timed countdown. Use   if necessary, to adjust the temperature and keep the cleaning solution from boiling over.

CAUTION

If the cleaning solution in the frypot starts to foam and boil over, immediately turn the POWER switch to OFF, or damage to components could result.

9. Using the fryer brush (Henny Penny part number 12105), scrub the inside of the frypot, and around the counter-top of the fryer. Never use steel wool or green scrub pad to scrub the fryer. Place basket in frypot with cleaning solution and scrub basket.
10. After the cleaning mode has completed, turn the POWER switch to OFF. Pull-out drain handle and drain the cleaning solution from the frypot and discard. An "E-15" code will appear indicating the drain is open. Take drain pan and basket support to sink to be cleaned.

3-15. CLEAN-OUT MODE
(Continued)

11. Close drain and refill the frypot with 7-8.5 gallons of cold water.
12. Add approximately 8 ounces of distilled vinegar and re-start the Clean-Out Mode as described in step 8.

NOTICE

After completing a Clean-Out Mode, the controls assume fresh shortening is now in the frypot and adjust the temperature accordingly. If the Clean-Out Mode was aborted before starting the 15 minute cycle or if fresh shortening is not in the frypot, set the controls to “NEW” or “USED” shortening per Manually Setting New or Used Shortening Function Section

13. Using a clean brush, scrub the interior of the frypot to neutralize the alkaline left by the cleaning compound.
14. Drain the vinegar rinse water into the drain pan by pulling the drain handle. Close the drain after pot has emptied.

Remove the drain pan with the water/ vinegar solution and discard down the drain. Place the drain pan assembly back under the fryer

15. Perform a final rinse of the frypot. Drain the water into the drain pan by pulling the drain handle. After the rinse water has drained. close the drain valve, remove the drain pan assembly and discard rinse water.
16. Dry the drain pan and frypot thoroughly. Install the basket support.

NOTICE

Make sure the inside of the frypot, the drain valve opening, and all parts that come in contact with the new shortening are as dry as possible.

3-15. CLEAN-OUT MODE
(Continued)

CAUTION

Make sure the inside of the vat, the drain valve opening, and all the parts that come in contact with the new oil are as dry as possible.

17. Make sure drain is closed and return filter pan assembly, with new filter envelope, to the fryer. Fill the vat with oil following **Filling or Adding Oil** instructions from Section 3-5.

3-16. CHECK/REPLACE FILTER
DRAIN PAN O-RINGS

To prevent oil leaking, and to keep filtering process operating properly, the filter drain pan o-rings should be inspected for nicks and tears at least every 3 months. Figure 1



Figure 1

3-16. CHECK/REPLACE FILTER DRAIN PAN O-RINGS
(Continued)



Figure 2



Figure 3

1. Open the door, push down on the drain pan stop and pull-out the drain pan assembly, using the handle on the drain pan. Figures 2 & 3.













This pan could be hot! Use protective cloth or glove, or severe burns could result.

2. Visually check the 3 o-rings on the tube of the filter drain pan for any cracks or breaks and replace if necessary.
3. To replace o-ring, use a small, flat-bladed screwdriver, pry up on o-ring and pull off of end of tube. Roll new o-ring into notch on tube. Lubricate o-rings on filter tube with fresh, cold oil & push filter drain pan into position. Figure 4



Figure 4

3-17. MANUALLY SETTING NEW OR USED SHORTENING

1. Turn the POWER switch to OFF.
2. Press and hold  while turning the POWER switch to ON, until “IS OIL NEW OR USED?” shows in the display.
3. Press  for new shortening, or  for used shortening.
4. If  was pressed, “OIL IS NEW?” shows in the display.
Press  for YES, and “THANK YOU” shows in the display, and controls resume normal operation.
5. If  was pressed, “OIL IS USED?” shows in the display.
6. Press  for YES, and “HOW OLD IS OIL?” shows in display.
7. Press   to set the age of the shortening.
8. Press  . “THANK YOU” shows in the display and controls resume normal operation.

3-18. INFO BUTTON STATS

Actual Oil Temperature

1. Press  and the actual oil temperature shows in the display, ^{INFO} for each vat.

Set-point Temperature

2. Press  twice and SP shows in the display, along with the set-point (preset) temperature of each vat.

Recovery Information for each Vat

3. Press  3 times and display shows:
 - a. No. of remaining cook cycles before Filter Lockout
 - b. Average cook temperature
 - c. Current temp. probe reading and rate of temp. rise
 - d. Today's date
 - e. P=Protection Probe temperature
L=Level Probe temperature
Main Probe temperature

NOTICE

If no buttons are pressed within 5 seconds in any of stats modes, the controls revert back to normal operation.

As in all food service equipment, the Henny Penny open fryer does require care and proper maintenance. The table below provides a summary of scheduled maintenance procedures to be performed by the operator.

**3-19. PREVENTIVE
MAINTENANCE
SCHEDULE**

<u>Procedure</u>	<u>Frequency</u>
Filtering of shortening	Daily
Changing the filter envelope	Daily
Lubricate filter pan o-rings	Every filter envelope change
Lubricate JIB (oil reservoir) o-rings	When reservoir is removed
Changing of oil	When oil smokes, foams up violently, or tastes bad
Cleaning the vat	Every change of oil
Inspect filter pan o-rings	Quarterly
Inspect oil reservoir o-rings (Section 3-10)	Quarterly

SECTION 4. INFORMATION MODE

This historic information can be recorded and used for operational and technical help and allows you to view the following:



- | | |
|---|--|
| <ul style="list-style-type: none"> • 1. E-LOG • 2. P-LOG • 3. HEAT UPS • 4. LEFT COOK DATA • 5. RIGHT COOK DATA • 6. TODAY'S DATA • 7. PREV DAY - SUN • 8. 7-DAY TOTALS • 9. OIL DATA • 10. PREV OIL DATA | <ul style="list-style-type: none"> • 11. INPUT INFO • 12. OUTPUT INFO • 13. POT TMP • 14. LVL TMP • 15. PRO TMP • 16. SSR TMP • 17. CPU TMP • 18. ANALOG INFO • 19. AC VOLTS • 20. AMPS INFO |
|---|--|

NOTICE

Not all Information Mode functions are discussed in this section. To ensure proper operation of fryer, please consult Henny Penny Corp. before changing any of these settings. For more information on these functions, contact Technical Support at 1-800-417- 8405, or 1-937-456-8405.

4-1. INFORMATION MODE DETAILS

1. E-LOG (error code log)

Press  and  buttons at the same time and “*INFO MODE*” shows in the display, followed by “1. E-LOG”.

NOTICE

Press  and  to exit Information Mode at any time.

Press  and “A. (date & time) *NOW* show in displays. This is the present date and time.

Press  and if an error was recorded, “B. (date, time, and error code information)” shows in display. This is the latest error code that the controls recorded. Sometimes the characters “L:” and “R:” appear in front of the error code on the display which refers to the left or right vat of a split vat.

Press  and the next latest error code information is seen.

Up to 10 error codes (B to K) can be stored in the E-LOG section.

Press  to continue to P-Log.

4-1. INFORMATION MODE
DETAILS (Continued)

2. P-LOG (power-up log)

Press **▼** and “2A. (date & time) *NOW* shows in display. This is the present date and time.

Press **▼** and the latest power-up is shown, “2B. (date, time,) PWR-UP”.

Press **▼** and the next latest power-up date is shown. Up to 10 power-ups (2B to 2K) can be stored in P-LOG section.

Press **Ⓟ** to continue onto the heat-up log.
PROG

3. HEAT-UP'S

Press **▼** and “3A. (date & time) *NOW* shows in display. This is the present date and time.

Press **▼** and the latest heat-up is shown, along with the heat-up rate, ex: “3B. MAY-22, 8:37A 1.25”. The heat rate is the maximum rate (degrees/second) the controller recorded during the shown time frame.

Press **▼** and the next latest heat-up is shown. Up to 10 heat-ups (3B to 3K) can be stored in the Heat-Up Log.

Press **Ⓟ** to continue onto the COOK DATA.
PROG

4. LEFT COOK DATA

Press **▼** to step through the following data:

FUNCTION	DISPLAY EXAMPLE
Time of last Cook Cycle started	4A. STARTED 10.25A
Product (last product cooked)	4B. PRODUCT -1-
Ready? (fryer ready before start?)	4C. READY? YES
Drop detect status	4D. DETECT X NO
Drop adjust (real time seconds)	4E. DROP ADJ T-14
Cook time adj (clock adjust)	4F. CK TM ADJ -13
Actual elapsed cook time (seconds)	4G. ACT TIME 2:23
Stopped: Time remaining, or secs past done	4H. STOP DONE+1
“Slow cook” for this cycle?	4I. SLOW? NO
Overloaded? (Bad batch)	4J. OVRLD? NO
Avg Temp during Cook Cycle	4K. AVG TMP 343°F
Max voltage during Cook Cycle	4L. MAX VOLT 99%
Min voltage during Cook Cycle	4M. MIN VOLT 97%
Max amps during Cook Cycle	4N. MAX AMPS 33
Min amps during Cook Cycle	4O. MIN AMPS 33

Press **Ⓟ** to continue onto the RIGHT COOK DATA.
PROG

**4-1. INFORMATION MODE
DETAILS (Continued)**

5. RIGHT COOK DATA

Press  button to start viewing the cook data.

FUNCTION	DISPLAY EXAMPLE
Time of last Cook Cycle started	5A. STARTED 10.25A
Product (last product cooked)	5B. PRODUCT -1-
Ready? (fryer ready before start?)	5C. READY? YES
Drop detect status	5D. DETECT X NO
Drop adjust (real time seconds)	5E. DROP ADJ T-10
Cook time adj (clock adjust)	5F. CK TM ADJ -13
Actual elapsed cook time (seconds)	5G. ACT TIME 2:23
Stopped: Time remaining, or secs past done	5H. STOP DONE+1
“Slow cook” for this cycle?	5I. SLOW? NO
Overloaded? (Bad batch)	5J. OVRLD? NO
Avg Temp during Cook Cycle	5K. AVG TMP 343°F
Max voltage during Cook Cycle	5L. MAX VOLT 99%
Min voltage during Cook Cycle	5M. MIN VOLT 97%
Max amps during Cook Cycle	5N. MAX AMPS 33
Min amps during Cook Cycle	5O. MIN AMPS 33

Press  to continue onto the TODAY'S DATA.

6. TODAY'S DATA (automatically resets each day)

Press  to step through the following data:



FUNCTION	DISPLAY EXAMPLE
Today's Date	6A. DATE APR-12
Time of day last heat-up was completed	6B. LAST HEAT 9:45A
Peak heat-up rate(°F/Sec)for last heat-up	6C. LAST RATE 0.82
Was last heat-up acceptable?	6D. LAST OK? YES
Heat Cap. status (based on last 4 ht-ups)	6E. HEAT CAP GOOD
Number of monitored heat-ups today	6F. HEAT-UPS 2
Number of slow heat-ups	6G. SLOW HT'S 0
Max time to heat 270°F to 310°F today	6H. MAX HT TM 1:17
Lowest “peak rate” for today's heat-ups	6I. MIN RATE 0.82
Maximum voltage today (when fryer on)	6J. MAX VOLT 99%
Minimum voltage today (when fryer on)	6K. MIN VOLT 95%
No.of “low voltage” warnings generated	6L. LO VOLT'S 0
Maximum amp draw today	6M. MAX AMPS 35
Minimum amp draw today	6N. MIN AMPS 33
Number of “low amps” warnings today	6O. LO AMP'S 0
Non-cooking time (hh:mm) fryer was on	6P. IDLE HRS 1:23
Oil Wear accumulated so far today	6Q. OIL WEAR 3
Total number of Cook Cycles today	6R. TOT CK'S 11
Number of cycles started before Ready	6S. NOT RDY'S 2
No. cycles quit early, 0:11 or more rem.	6T. QUIT 11+ 0
No. cycles beeped *DONE *21 sec or more	6U. DONE 21+ 1
Individual product cook counts	6V. Px CK CT 2
Individual product “not detected” counts	6W. Px NO DET 0
Individual product “slow cook” counts	6X. Px SLO CT 0
Ind. product “frozen or overloaded”	6Y. Px FRZ/OV 0

(During steps 6V through 6Y, press the product buttons (or Manual Prog) to see data on individual product items)

**4-1. INFORMATION MODE
DETAILS (Continued)**

Press  to continue onto PREV-DAY-SUN log.

7. PREV DAY - SUN

Press  to step through the following data. During each step, press  to choose the day of the week, of the past 7 days.

FUNCTION	DISPLAY EXAMPLE
Day this data was recorded for	7A. DATE APR-8
Time of day last heat-up was completed	7B. LAST HEAT 8:15P
Peak heat-up rate (°F/Sec) - last heat-up	7C. LAST RATE 0.88
Was that day's last heat-up acceptable?	7D. LAST OK? YES
Heat cap. status (based on last 4 ht-ups)	7E. HEAT CAP GOOD
Number of monitored heat-ups that day	7F. HEAT-UPS 7
Number of slow heat-ups	7G. SLOW HT'S 0
Max heat time 270°F to 310°F that day	7H. MAX HT TM 1:11
Lowest "peak rate" - that day's heat-ups	7I. MIN RATE 0.67
Max voltage that day (when fryer on)	7J. MAX VOLT 102%
Min voltage that day (when fryer on)	7K. MIN VOLT 98%
No. of "low voltage" warnings generated	7L. LO VOLT'S 0
Maximum amp draw that day	7M. MAX AMPS 35
Minimum amp draw that day	7N. MIN AMPS 34
No. of "low amps" warnings that day	7O. LO AMP'S 0
Non-cooking time (hh:mm) fryer was on	7P. IDLE HRS 7:09
Oil wear accumulated that day	7Q. OIL WEAR 39
Total number of Cook Cycles that day	7R. TOT CK'S 18
Number of cycles started before ready	7S. NOT RDY'S 2
No. cycles quit early, (0:11 or more remaining)	7T. QUIT 11+ 1
No. cycles beeped *DONE* 21 sec or more	7U. DONE 21+ 3
Individual product cook counts	7V. Px CK CT 12
Individual product "not detected" counts	7W. Px NO DET 1
Individual product "slow cook" counts	7X. Px SLO CT 0
Individual product "frozen or overloaded"	7Y. Px FRZ/OV 1

(During steps 7V through 7Y, press the product buttons (or Manual Prog) to see data on individual product items.)

Press  to continue onto 7-DAY TOTALS log.

**4-1. INFORMATION MODE
DETAILS (Continued)**

8. 7-DAY TOTALS

Press  to step through the following data:

FUNCTION	DISPLAY EXAMPLE
Oldest day in the “previous days” history	8A. SINCE APR-5
Number of days with data included in totals	8B. DAYS CNT 6
Number of monitored heat-ups	8C. HEAT-UPS 30
Number of slow heat-ups	8D. SLOW HT’S 1
Max time to heat 270°F to 310°F	8E. MAX HT TM 3:25
Lowest “peak rate” of all heat-ups	8F. MIN RATE 0.47
Maximum voltage	8G. MAX VOLT 102%
Minimum voltage	8H. MIN VOLT 91%
No. of “low voltage” warnings generated	8I. LO VOLT’S 0
Maximum amp draw	8J. MAX AMPS 35
Minimum amp draw	8K. MIN AMPS 32
Number of “low amps” warnings	8L. LO AMP’S 0
Non-cooking time (hrs) while fryer was on	8M. IDLE HRS 43
Total oil wear accumulated	8N. TOT WEAR 278
Total number of Cook Cycles	8O. TOT CK’S 125
Number of cycles started before ready	8P. NOT RDY’S 7
No. cycles quit early, (0:11 or more remaining)	8Q. QUIT 11+ 1
No. cycles beeped *DONE* 21 sec or more	8R. DONE 21+ 3
Individual product cook counts	8S. Px CK CT 77
Individual product “not detected” counts	8T. Px NO DET 3
Individual product “slow cook” counts	8U. Px SLO CT 0
Individual product “frozen or overloaded”	8V. Px FRZ/OV 1

(During steps 8S through 8V, press the product buttons (or Manual Prog) to see data on individual product items.)

Press  to continue onto OIL DATA log.

4-1. INFORMATION MODE
DETAILS (Continued)

9. OIL DATA (current batch; resets by Clean-Out Mode)
Press  to step through the following data:

FUNCTION	DISPLAY EXAMPLE
The day current batch of oil was started	9A. SINCE APR-1
No. of days with data included in totals	9B. DAYS CNT 10
Number of monitored heat-ups	9C. HEAT-UPS 75
Number of slow heat-ups	9D. SLOW HT'S 2
Max time to heat 270°F to 310°F	9E. MAX HT TM 3:25
Lowest "peak rate" of all heat-ups	9F. MIN RATE 0.43
Maximum voltage	9G. MAX VOLT 102%
Minimum voltage	9H. MIN VOLT 91%
No. of "low voltage" warnings generated	9I. LO VOLT'S 0
Maximum amp draw	9J. MAX AMPS 35
Minimum amp draw	9K. MIN AMPS 32
No. of "low amps" warnings	9L. LO AMP'S 0
Non-cooking time (hrs) while fryer was on	9M. IDLE HRS 43
Total oil wear accumulated	9N. TOT WEAR 278
Total number of Cook Cycles	9O. TOT CK'S 125
Number of cycles started before ready	9P. NOT RDY'S 7
No. cycles quit early, (0:11 or more remaining)	9Q. QUIT 11+ 1
No. cycles beeped *DONE* 21 sec or more	9R. DONE 21+ 3
Individual product cook counts	9S. Px CK CT 77
Individual product "not detected" counts	9T. Px NO DET 3
Individual product "slow cook" counts	9U. Px SLO CT 0
Individual product "frozen or overloaded"	9V. Px FRZ/OV 1

(During steps 9S through 9V, press the product buttons (or Manual Prog) to see data on individual product items.)

Press  to continue onto PREV OIL DATA log.

4-1. INFORMATION MODE
DETAILS (Continued)

10. PREV OIL DATA (moved here from Oil Data log;
assumes new shortening)

Press **▽** to step through the following data:

FUNCTION	DISPLAY EXAMPLE
The day previous batch of oil was started	10A. BEGAN MAR-9
No. of days with data included in totals	10B. DAYS CNT 18
Number of monitored heat-ups	10C. HEAT-UPS 98
Number of slow heat-ups	10D. SLOW HT'S 0
Max time to heat 270°F to 310°F	10E. MAX HT TM 1:31
Lowest "peak rate" of all heat-ups	10F. MIN RATE 0.57
Maximum voltage	10G. MAX VOLT 101%
Minimum voltage	10H. MIN VOLT 96%
Number of "low voltage" warnings generated	10I. LO VOLT'S 0
Maximum amp draw	10J. MAX AMPS 35
Minimum amp draw	10K. MIN AMPS 33
Number of "low amps" warnings	10L. LO AMP'S 0
Non-cooking time (hours) while fryer was on	10M. IDLE HRS 62
Total oil wear accumulated	10N. TOT WEAR 1523
Total number of Cook Cycles	10O. TOT CK'S 653
Number of cycles started before Ready	10P. NOT RDY'S 25
Num. cycles quit early, with 0:11 or more rem	10Q. QUIT 11+ 3
Num. cycles beeped *DONE* 21 sec or more	10R. DONE 21+ 13
Individual product cook counts	10S. Px CK CT 466
Individual product "not detected" counts	10T. Px NO DET 31
Individual product "slow cook" counts	10U. Px SLO CT 0
Individual product "frozen or overloaded"	10V. Px FRZ/OV 5

(During steps 10S through 10V, press the product buttons (or Manual Prog) to see data on individual product items.)



Press **PROG** to continue onto INP A_VHDSF_M check.

4-1. INFORMATION MODE
DETAILS (Continued)

11. INP A_VHDSF_M

This mode displays the status of components and inputs. If the input signal is detected, an identifying letter is displayed (see below). If the signal is not detected, “_” is displayed.

With the POWER switch turned to ON, and all inputs detected, “H_P_A_VHDSF_M” shows in the display. See below for “definition” of codes.

- A = POWER Switch turned to ON
- V = Volts - 24 VAC detected
- H = High Limit - If “H” is present, the high limit is good; if “H” is missing, the high limit is tripped (overheated) or faulty
- D = DRAIN SWITCH - If “D” is present, the drain handle is closed; if “D” is missing, the drain is open or faulty
- S = POWER switch “on” interlock circuit: if “S” is present, the POWER switch is in the ON position; if the “S” is missing, the POWER switch is either off, failed, or wired incorrectly
- F = FAN
- M = MV - Detects 24 V jumper to MV terminal

Press  to view the specific status of each input. An underscore (“_”) indicates the input is not presently detected. A Checkmark (“√”) indicates the signal is detecting a normal input. A blinking (“X”) indicates the signal is presently detected, but is detected as a half-wave (partially failed) input.

NOTICE

The V, H, D, S, F, and M signals below are wired in series. The first signal missing out of this sequence will generally cause all signals to the right of it to be missing as well.

Press  to continue onto OUTP H* check.4
PROG

4-1. INFORMATION MODE
DETAILS (Continued)

12. OUTPUT*

This mode displays the status of components and outputs. If the output signal is detected, an identifying letter is displayed (see below), followed by an “*”. If the output is off, “_” is displayed.

H = Heat output

If heat is on, “H*” shows in display. If heat is off, “H_” shows in display. If controls senses a problem with the heat output, “H*” shows in display, with the “*” flashing.

Press  to view the “amps” status of output.

“H√” in the display means the amps are good. A flashing “X” behind the H means a problem exists.

Press  to view the No Connect/Ground (“NC/GD”) status of the output. This monitors a possible problem with the relays on the output PC board.

“H√” in the display means everything on the output PC board is good. A flashing “X” behind the H means a problem exists.

Press  to view the outputs and inputs (see step 10) together.

Press  to continue onto the POT TMP reading.
PROG

13. POT TMP

This step shows the present shortening temperature. The display shows “13. POT TMP (temp.)”.

Press  to continue onto the CPU TMP reading.
PROG

14. CPU TMP

This step shows the present PC board temperature.

Press  to continue onto the ANALOG reading.
PROG

4-1. INFORMATION MODE
DETAILS (Continued)

15. ANALOG <1> 2344

This step displays the present status of any channel of the controller's a to d converter. This feature may be useful to a technician troubleshooting the fryer or controller.

The displayed value can be toggled between volts and bits by pressing  . If the displayed value has a decimal point,

it is voltage (0 to 5 VDC). If no decimal point is shown, the value is a-to-d bits (0 - 4095).

Press  to continue onto AC VOLTS reading.

16. AC VOLTS 98%

This item displays the present status of the line voltage supply to the fryer. The displayed value is averaged over a 10-second period, so brief dips or fluctuations in the voltage might not show up in this display.

The voltage is normally displayed as a “percent of nominal” value, where 100% would indicate that voltage is right on the nominal value (i.e. 208 volts for a 208v fryer). The display can be toggled to an actual voltage value by pressing  .

Press  to continue onto AMPS reading.

17. AMPS 33 33 33

For electric fryers, this display shows the present readings from the fryer's amps sensors, which monitor the electrical current supplied to the heaters.

On open fryers, these values indicate the current through each individual heater coil. On 208 or 240 volt units, this value should be close to the value on the data plate. On 480 volt fryers, this value should be the value on the data plate multiplied by 1.76.

The “amps” values should normally cycle on and off with the HEAT ON light, and all three values should be about the same.

NOTICE

Press and hold  to exit Information Mode at any time, or after 2 minutes, controls automatically exit back to normal operation.

SECTION 5. TROUBLESHOOTING

5-1. INTRODUCTION

This section provides troubleshooting information in the form of an easy to read table.

If a problem occurs during the first operation of a new fryer, recheck the installation and operation sections of this manual.

5-1. TROUBLESHOOTING

To isolate a malfunction, proceed as follows:

1. Clearly define the problem (or symptom) and when it occurs.
2. Locate the problem in the Troubleshooting table.
3. Review all possible causes. Then, one-at-a-time work through the list of corrections until the problem is solved.
4. Use the Diagnostic Mode to identify the problem and make possible adjustments.

NOTICE

If a problem keeps reoccurring, have a qualified service technician check the fryer for other causes.

5-3. TROUBLE SHOOTING GUIDE

COOKING SECTION

Problem	Cause	Correction
Product color not correct: Too dark (some batches)	<ul style="list-style-type: none"> • Temperature programmed too hot • Breeding product too far ahead • Done alarm ignored for more than 20 seconds • Wrong product button pressed 	<ul style="list-style-type: none"> • See Diagnostic Mode D 10; if temperature settings have been changed, have the controls reinitialized • Bread product just before frying • If the fryer hasn't been used since the problem batch, see Information Modes 4 H and 5 H; for more information on this problem, see Information Modes 6 U, 7 U, 8 R, 9 R, or 10 R • Be sure to press the correct product button; if the fryer hasn't been used since the problem batch, see Information Modes 4 B and 5 B, to see what product was selected
Too dark (all batches)	<ul style="list-style-type: none"> • Temperature probe out of calibration • Shortening too old • Shortening too dark • Faulty probe; "E6" 	<ul style="list-style-type: none"> • See Diagnostic Mode D 1 to adjust color of product • Check temperature probe calibration; see Checking Temperature Probe Calibration Section; if less than 15 degrees off, have probe calibrated; if more than 15 degrees off, replace probe • If shortening is smoking or has burnt taste, change shortening • See Diagnostic Mode D 2; change shortening if controls indicate it should be changed • Filter shortening • Change shortening • If probe can't be recalibrated, have probe replaced does not reset, high limit must be replaced

COOKING SECTION (Continued)

Problem	Cause	Correction
Too light (all batches)	<ul style="list-style-type: none"> • Temperature probe out of calibration • Slow fryer heat-up/recovery • Oil usage wasn't set for new shortening 	<ul style="list-style-type: none"> • See Diagnostic Mode D 1 to adjust color of product • Check temperature probe calibration; see Checking Temperature Probe Calibration Section; if less than 15 degrees off, have probe calibrated; if more than 15 degrees off, replace probe • See Diagnostic Mode D 4, for present day's performance; or see Information Modes 5, 6, 7, 8, 9, and 10 for more information on this problem • Low voltage; see Diagnostic Mode D 3 for present day's voltage performance; for more information see Information Modes 4, 5, 6, 7, 8, 9, 10 & 16 • See Diagnostic Mode D 2 for the age of the oil; see Basic Operations Section for setting the age of the oil
Too light (some batches)	<ul style="list-style-type: none"> • Temperature programmed too low • Product placed in shortening before proper temperature • Wrong cook button pushed • Cook Cycle aborted before alarm and "DONE" flashes • Too large of a product batch 	<ul style="list-style-type: none"> • See Diagnostic Mode D 10 if temperature settings have been changed without authorization, have the controls reinitialized • If fryer hasn't been used since problem batch, see Information Mode 4 C and 5 C; for more information see Information Modes 6 S, 7 S, 8 P, 9 P, and 10 P • If fryer hasn't been used since problem batch, see Information Modes 4 B and 5 B to see what product was selected probe replaced does not reset, high limit must be replaced • No more than 15 lb of product perbatch; see Diagnostic Mode D 5 to see if the controls sensed any overloaded batches

COOKING SECTION (Continued)

Problem	Cause	Correction
Dryness of product	<ul style="list-style-type: none"> • Moisture loss prior to cooking • • Over-cooking the product • • Time of cook cycle set too long • • Wrong product button pushed 	<ul style="list-style-type: none"> • Use fresh product • Cover product with plastic wrap, reducing evaporation • Done alarm ignored for more than 20 seconds if the fryer hasn't been used since the problem batch, see Information Modes 4 H and 5 H; for more information on this problem, see Information Modes 6 U, 7 U, 8 R, 9 R, or 10 R • See Diagnostic Mode D 2 for the age of the oil; see Basic Operations Section for setting the age of the oil • See Diagnostic Mode D 10; if time settings have been changed, have the controls reinitialized • If fryer hasn't been used since problem batch, see Information Modes 4 B and 5 B to see what product was selected
Burned taste	<ul style="list-style-type: none"> • Burned shortening flavor • Shortening needs filtering • Frypot not properly cleaned 	<ul style="list-style-type: none"> • Replace shortening • Filter shortening more often • Drain and clean frypot

COOKING SECTION (Continued)

Problem	Cause	Correction
<p>Product not done</p>	<ul style="list-style-type: none"> • Cook Cycle aborted before alarm and “DONE” flashes • Too large of a product batch • Wrong cook button pushed • Temperature programmed too low or not programmed properly • Temperature probe out of calibration • Slow fryer heat-up/recovery 	<ul style="list-style-type: none"> • See Diagnostic Mode D 7 to see how many times the Cook Cycle was stopped before the end of the cycle • No more than 15 lb of product per batch; see Diagnostic Mode D 5 to see if the controls sensed any overloaded batches • If fryer hasn’t been used since problem batch, see Information Modes 4 B and 5 B to see what product was selected • See Diagnostic Mode D 10; if temperature settings have been changed, have the controls reinitialized • Check temperature probe calibration; see Checking Temperature Probe Calibration Section; <ul style="list-style-type: none"> a. If less than 5° off, see Diagnostic Mode D 1 b. If between 5 and 15 degrees off, calibrate probe; if more than 15 degrees off, replace probe • See Diagnostic Mode D 4, for present day’s performance; or see Information Modes 5, 6, 7, 8, 9, and 10 for more information on this problem • Low voltage; see Diagnostic Mode D 3 for present day’s voltage performance; for more information see Information Modes 4, 5, 6, 7, 8, 9, 10 & 16

POWER SECTION

Problem	Cause	Correction
With POWER switch in ON position, fryer is completely without power	<ul style="list-style-type: none"> • Open circuit 	<ul style="list-style-type: none"> • Check to see if fryer is plugged in • Check wall circuit breaker or fuse • Have a qualified service technician check power supply and POWER switch

FILTER SYSTEM SECTION

Filter motor runs but pumps shortening slowly	<ul style="list-style-type: none"> • Pump clogged • Filter line connection loose • Solidified shortening in lines 	<ul style="list-style-type: none"> • Have pump cleaned • Tighten all filter line loose connections • Clear all filter lines of solidified shortening
FILTER PUMP switch on, motor does not run	<ul style="list-style-type: none"> • Defective FILTER PUMP switch • Defective motor • Motor thermal protector tripped 	<ul style="list-style-type: none"> • Have switch checked • Have motor checked • Reset thermal protector per Filter Pump Motor Filter Protector Section
Motor hums but will not pump	<ul style="list-style-type: none"> • Clogged lines or pump removed 	<ul style="list-style-type: none"> • Have pump and lines and cleaned • Have pump seal, rotor and rollers replaced
Slow pumping oil or air in filtration lines	<ul style="list-style-type: none"> • Plug-in-play not properly seated. • O-rings not properly seated. 	<ul style="list-style-type: none"> • Inspect plug-in-play to ensure all o-rings are present and properly seated. • Connect plug-in-play and verify it is properly seated.

HEATING OF SHORTENING SECTION

Problem	Cause	Correction
Shortening will not heat	<ul style="list-style-type: none"> Blown fuse or tripped circuit breaker at supply box Faulty cord and plug Faulty PC board Faulty or tripped high limit; “E10” Drain valve open; “E15” Possible faulty probe; “E6” Possible faulty contactor 	<ul style="list-style-type: none"> Reset breaker or replace fuse Check cord and plug and check power at wall receptacle Have control panel checked Reset high limit per Operating Components Section; if high limit doesn’t reset, have it checked Close drain valve Have temperature probe checked See Diagnostic Modes D 4; if “CHECK COILS, CONTACTORS AND WIRING” shows on display, have contactors and wiring checked
	<ul style="list-style-type: none"> Faulty POWER switch Faulty drain switch; “E15” 	<ul style="list-style-type: none"> See Information Mode 11 and check to see if the input code is present; if not, have fryer checked by a certified service technician
Shortening heating slowly	<ul style="list-style-type: none"> Low or improper amps 	<ul style="list-style-type: none"> See Information Mode 17 for present amperage; or see Information Modes 4, 5, 6, 7, 8, 9, and 10 for more information on this problem. Diagnostic Mode D 4 gives present day’s heating performance

HEATING OF SHORTENING SECTION (Continued)

Problem	Cause	Correction
Shortening heating slowly (continued)	<ul style="list-style-type: none"> • Low or improper voltage • Wire(s) loose • Faulty PC board 	<ul style="list-style-type: none"> • See Diagnostic Modes D 3 & D 4 for present day's voltage and heating performance; or see Information Modes 4, 5, 6, 7, 8, 9, 10 and 15 for more information on this problem • Have wires tightened • Have control panel checked
	<ul style="list-style-type: none"> • Weak or burnt out elements (elec. model) • Burnt or charred connectors • Faulty contactor 	<ul style="list-style-type: none"> • See Diagnostic Modes D 4; see if "CHECK COILS, CONTACTORS AND WIRING" shows on display; if so, have fryer checked by a certified service technician



5-4. DIAGNOSTIC MODE
DETAILS

The Chick-fil-A fryer controllers provide Diagnostic functions that let an Operator review operating and performance data for the fryer.

The information provided by Diagnostic Mode can be used to monitor procedural errors, such as, not waiting for the READY light before starting a Cook Cycle, canceling cycles early, etc.





In addition, Diagnostic Mode allows slight adjustment to product color, reports the age and accumulated wear of the oil, and reports information about the performance of the line voltage supply.

Accessing Diagnostic Mode



To activate Diagnostic Mode, press  **PROG**, then press  **4** .
The controller displays the following message:

“*DIAGNOSTIC*”
“*REPORT*”

When this introduction message is finished, the controller displays Diagnostic step D 1 (see below).

 **DOWN**  **UP** are used to step through the report items. Press  to step forward to the next item. Press  to step backward through the report items.

The report information is grouped into sections, D 1 through D 10. Most sections have several related items.



To toggle between English and Spanish Display Mode, press  **PROG** then press  **6** .

To exit Diagnostic Report Mode at any point, press  **CANCEL** **2** .

5-4. DIAGNOSTIC MODE
DETAILS (Continued)



D 1: Color Adjustment

This step lets the user make slight adjustments to the product color. The first step of this item asks “**IS PRODUCT COLOR OK?**”

If product color is okay and no change is desired press  or  to move on to the next item, or press  to exit Diagnostic Mode.

If a change is desired, press  (i.e. color is not okay). The controller shows “**ADJUST DARKNESS**”, then displays the darkness control slider:

“ **LT** - - - - - + - - - - - **DK** ”

A blinking asterisk (*) indicates the current position. and  are used to adjust the darkness setting. 

To make the product darker, press  to move the blinking “ * “ toward the **DK** (darker) side.

To make the product lighter, press  to move the blinking “ * “ toward the **LT** (lighter) side.

When done adjusting, press  to exit and return to normal operating mode.

Any temperature adjustment activated by the Color Adjustment feature will be reflected in the normal setpoint display as part of the offset from the basic product cook temperature. To view the present regulating temperature, press  twice.

In the example, “**SETPT = 315°F + 6**” the product cook temperature is 315°F and has an additional offset of 6°F to compensate for the age of the oil, how long the fryer sits idle, and any color adjustments.

5-4. DIAGNOSTIC MODE
DETAILS (Continued)

D 2: Oil Wear Report

This section displays information about the age of the present batch of shortening.

The first step shows how many days of use this oil has:

“D2: THIS OIL IS”
“D2: 4 DAYS OLD”



The controller only counts days in which the fryer is in use.

Press ▼ to move on to the second step. This step shows the age of the shortening by percentage of its expected lifetime. The shortening's present, accumulated wear is compared to the wear setting at which the controller will prompt for the shortening to be changed.

“D2: THIS OIL IS”
“D2: 16% USED”

This information can be used as the oil nears the end of its life (i.e. 95%), to plan ahead for when a clean-out will be required.

Press ▼ to move on to the next section.

5-4. DIAGNOSTIC MODE
DETAILS (Continued)

D 3: Line Voltage Performance Report

This section displays information about how good the line voltage supply has been for the present day and for the present batch of oil.

The controller continually monitors the line voltage supplied to the fryer (when the fryer is on). If the line voltage drops below [90%] of its nominal value, the controller signals a “**LOW VOLTAGE**” alarm. This alarm sounds at the end of each cook cycle for which low voltage has been detected. While not cooking, the low voltage alarm can sound as frequently as every 30 minutes.

NOTICE

“[]” around a value, such as [90%], means this value is programmable and might change with later software versions.

Voltage Report for Today

If no low voltage warnings have been detected for the present day, the controller shows, “**D3: VOLTAGE OK, D3: TODAY**”

If one or more low voltage warnings have been detected for the present day, the following sequence example could be displayed:

“**D3: YOU HAD 3**”
“**D3: LOW VOLTAGE**”
“**D3: WARNINGS**”
“**D3: TODAY**”

(Press ▾)

“**D3: MIN VOLTAGE**”
“**D3: TODAY = 83%**”

(Press ▾)

“**D3: MAX VOLTAGE**”
“**D3: TODAY = 101%**”

(Press ▾)

5-4. DIAGNOSTIC MODE
DETAILS (Continued)

If one or more low voltage warnings have been detected before today, the following sequence is displayed:

“D3: BEFORE TODAY”
“D3: 27 LOW VOLT”
“D3: WARNINGS”
“D3: ON THIS OIL”

(Press ▼)

“D3: MIN VOLTAGE”
“D3: BEFORE TODAY”
“D3: = 85%”

(Press ▼)

“D3: MAX VOLTAGE”
“D3: BEFORE TODAY”
“D3: = 105%”

Press ▼ to advance to the next section.

D 4: Heating Capacity Report

This section reports the present status of the heating system.

The controller examines a history of heat-up data and determines whether or not the heating system is operating normally. The “heat capacity” is said to be bad only if the most recent heat-up failed to meet the expected heat-up rate and three of the last four heat-ups also failed to achieve the expected rate. That is, a single slow heat-up will not trigger a “slow heat” warning. The slow heat warning is activated only after repeated low-rate heat-ups is observed.

The controller can’t assess the integrity of the heating system if the fryer has been experiencing voltage problems. Low heat rates observed in this situation might be due to voltage problems rather than heater problems.

5-4. DIAGNOSTIC MODE
DETAILS (Continued)

If the fryer has witnessed two or more low voltage warnings today, today, the following report is displayed:

“D4: CAN’T TEST”
“D4: HEAT CAPACITY”
“D4: DUE TO”
“D4: VOLTAGE”
“D4: PROBLEMS”

Otherwise, if the assessed heat capacity rating is presently “good” and at most only one heat-up today that failed to achieve the expected rate, the following report is displayed:

“D4: HEATING”
“D4: CAPACITY”
“D4: IS FINE”

Otherwise, if the heat capacity is presently assessed as “bad”, or presently assessed as “good” but two or more heat-ups today have not reached the expected heat-up rate, the following report sequence is generated:

“D4: YOU HAD 75%”
“D4: SLOW HEATS”
“D4: TODAY”

(Press )

“D4: HAVE 20%”
“D4: SLOW HEATS”
“D4: THIS OIL”

(Press )

“D4: HAD 0%”
“D4: SLOW HEATS”
“D4: LAST OIL”

(Press )

If the heat capacity is assessed as bad (low heat-up rate on last heat-up, and on three of the last four heat-ups), then the heating coils are suspect and the following is displayed:

“D4: CHECK COILS,”
“D4: CONTACTORS,”
“D4: AND WIRING”

5-4. DIAGNOSTIC MODE
DETAILS (Continued)

Otherwise, the heating coils are presumed to be good and the following messages appear:

“D4: HEATER COILS”

“D4: APPEAR OK”

(Press )

“D4: CHECK”

“D4: CONTACTORS,”

“D4: CONNECTIONS,”

“D4: AND WIRING”

D 5: Cook Times (Slow Cooks) Report

This summarizes the “slow cooking” status for each product.

Actual cook times for Cook Cycles can vary from the programmed cook time setting, due to the load compensation feature. Load compensation slows the cook timer down when the actual shortening temperature is below a reference value, and speeds up the cook timer countdown when shortening temperature is above the reference.

When the shortening temperature is lower than expected during a Cook Cycle, the overall cook time will be longer than normal. If the actual cook time stretches beyond a programmed limit, the controller counts a “**SLOW COOK**” event and sounds an alarm at the end of the Cook Cycle.

If low voltage or low amps are detected during the Cook Cycle, the warning message indicates “**LOW VOLTAGE**” or “**LOW AMPS**”, but the cycle will still count as a “slow cook”. If the voltage and amps have been fine during the cook cycle but the cycle was started before the Ready light came on, then the warning message indicates “**SLOW COOK — WAIT FOR READY LIGHT**”. Otherwise, the slow cooking problem will be attributed to a “bad batch” of product: cooking too much in one load, or cooking product that is too cold.

If none of the products has more than 5% slow Cook Cycles today, the following report is made:

“D5: COOK TIMES”

“D5: LOOK OK”

“D5: TODAY”

5-4. DIAGNOSTIC MODE
DETAILS (Continued)

Otherwise, if one or more cook products have generated a “slow cook” warning more than 5% of the time, but four or more low voltage or slow heat-up warnings (any combination) have been generated today, then the report is as follows:

“D5: SOME SLOW”
“D5: COOKS TODAY”
“D5: MAYBE DUE TO”
“D5: VOLTAGE OR”
“D5: COIL PROBLEMS”

Such a report is saying the slow cooking may be the result of low voltage (which significantly reduces heat capacity) or the result of other problems with the heating system. In this case, the slow cook problems might not have anything to do with user error.

Otherwise, the slow cooking is generally attributed to user error: cooking too much product in one load, cooking frozen product (in the pressure fryer) when it should be fresh, or cooking before the Ready light illuminates, etc.

An individual **“XXXXX IS COOKING SLOWLY TODAY”** report item is generated for each product that has had more than 5% slow cook warnings today. This report item is triggered based solely on the number of slow cooks for that product, whether those slow cooks are due to voltage or heating problems, or due to cooking before ready, cooking too much, or cooking frozen product.

“D5: “FILET” (← Product Name)
“D5: COOKING SLOW”
“D5: TODAY”

(Press ▾)

If any of the slow cooks for this product are suspected as being due user error, a second, “bad batch” report is generated for the product.

“D5: “NUG-STRP” (← Product Name)
“D5: COOKING SLOW”
“D5: TODAY”

(Press ▾)

5-4. DIAGNOSTIC MODE
DETAILS (Continued)

“D5: POSSIBLE”
“D5: OVERSIZED”
“D5: OR FROZEN”
“D5: BATCH OF”
“D5: “NUG-STRP” (← Product Name)
“D5: DETECTED”
“D5: 3 TIMES”
“D5: TODAY”

(Press ▼)

“D5: POSSIBLE”
“D5: OVERSIZED”
“D5: BATCH OF”
“D5: “FRIES”
“D5: DETECTED”
“D5: 5 TIMES”
“D5: TODAY”

D 6: “Cooked Before Ready” Report

This section shows how many Cook Cycles were started before the READY light was on. This is strictly a user error.

If the fryer was in the ready range when the user begins to load product, but is out of the ready range by the time the cook cycle is started, the control will not give you an alarm.

If the fryer wasn't ready before loading, an alarm sounds and **“WAS NOT READY”** warning is generated. The number of times this has happened today is indicated by the following report item:

“D6: COOKED”
“D6: BEFORE READY”
“D6: 11 TIMES”
“D6: TODAY”

(Press ▼)

The number of **“WAS NOT READY”** warnings for this batch of shortening is also reported. Note that this value does not yet include the not ready warnings generated today.

5-4. DIAGNOSTIC MODE
DETAILS (Continued)

“D6: BEFORE TODAY,”
“D6: COOKED”
“D6: BEFORE READY”
“D6: 8 TIMES”
“D6: ON THIS OIL”

(Press )

Finally, the controller identifies how many times the not ready warning was generated for the previous batch of shortening:

“D6: LAST OIL,”
“D6: COOKED”
“D6: BEFORE READY”
“D6: 24 TIMES”

D 7: “Stopped Too Soon” Report

This section shows how many Cook Cycles were stopped early by the user, before the cook timer had counted down to “0:00” and the “*DONE*” was displayed. This is a user error.

Cycles that are canceled after cooking for less than 30 seconds are not counted here. For example, if a cycle is accidentally started, and the Cook Cycle is canceled after just a few seconds, this cycle will not be counted as a “Stopped Too Soon” Cycle.

Also, some allowance is given for stopping a cycle a little early. The user can cancel the cycle up to 10 seconds early without penalty.

Otherwise, however, any cycle that was stopped with more than 10 seconds remaining (**0:10**) on the cook clock will be counted as a “**STOPPED TOO SOON**” Cycle.

The first item displays what percent of cycles today were stopped with more than 0:10 remaining. All products are grouped into one count.

“D7: 8% OF LOADS”
“D7: WERE STOPPED”
“D7: TOO SOON”
“D7: TODAY”

(Press )

5-4. DIAGNOSTIC MODE
DETAILS (Continued)

The number of Stopped Too Soon Cycles for this batch of shortening is reported next. Note that this value does not yet include the Cook Cycles from today.

“D7: BEFORE TODAY “
“D7: 3% OF LOADS”
“D7: WERE STOPPED”
“D7: TOO SOON”
“D7: ON THIS OIL”

(Press )

Finally, the controller identifies percentage of Stopped Too Soon Cycles for the previous batch of shortening:

“D7: LAST OIL”
“D7: 5% OF LOADS”
“D7: WERE STOPPED”
“D7: TOO SOON”

D 8: “Beeped *DONE* Too Long” Report

Diagnostic Report section 8 reveals how many Cook Cycles beeped “*DONE*” for more than 20 seconds before the user pressed the Timer button to stop the cycle. This is strictly a user error.

The controller cannot detect when the product is actually removed from the fryer. It only identifies how long the controller beeped “*DONE*” before the user pressed  to stop the alarm.

The first item displays the percent of today’s Cook Cycles that beeped “*DONE*” for more than 20 seconds before the user pressed  to stop it. All products are grouped into one count.

“D8: 10% OF LOADS”
“D8: BEEPED ‘DONE’”
“D8: TOO LONG”
“D8: TODAY”

(Press )

5-4. DIAGNOSTIC MODE
DETAILS (Continued)

The number of Beeped 'DONE' Too Long Cycles for this batch of shortening is reported next. Note that this value does not yet include the cook cycles from today.

“D8: BEFORE TODAY “
“D8: 7% OF LOADS”
“D8: BEEPED ‘DONE’”
“D8: TOO LONG”
“D8: ON THIS OIL”

(Press ▼)

Finally, the controller identifies percentage of Beeped 'DONE' Too Long Cycles for the previous batch of shortening:

“D8: LAST OIL”
“D8: 6% OF LOADS”
“D8: BEEPED ‘DONE’”
“D8: TOO LONG”

D 9: Irregular Loading Report

For most Cook Cycles, the controller determines when the product was placed into the shortening. This report identifies the percentage of cycles for which this determination was not successful.

This “drop detection” detects most loads, but can fail for several reasons. Anytime the detection routine fails to find the true drop point, the controller logs an “irregular loading” count.

Examples of failed “drop detection” might be: the Operator takes too long to load the product to the time he presses the start button, or the Operator cooks a very light product load, one or two filets, for example.

In these instances, no drop point will be found and that Cook Cycle counts as an Irregular Loading Cycle. Only products that have more than 5% of loads with missed detection's are reported.

5-4. DIAGNOSTIC MODE
DETAILS (Continued)

Loading Report for Today

If no products have a “failed to detect” rate of more than 5%, the controller shows:

“D9: LOADING”
“D9: LOOKS OK”
“D9: TODAY”

Otherwise, for each product that has more than 5% of loads in which the controller failed to detect the drop point, the following message is displayed:

“D9: IRREGULAR”
“D9: LOADING”
“D9: FOR 8% OF”
“D9: “FILET” (← Product Name)
“D9: TODAY”

Loading Report for Present Batch of Shortening

The data for this batch of shortening does not yet include Cook Cycles from today.

If no products have a “failed to detect” rate of more than 5%, the controller shows:

“D9: LOADING”
“D9: LOOKS OK”
“D9: THIS OIL”

Otherwise, for each product that has more than 5% of loads in which the controller failed to detect the drop point, the following message is displayed:

“D9: FOR THIS OIL,”
“D9: IRREGULAR”
“D9: LOADING”
“D9: FOR 12% OF”
“D9: “NUG-STRP” (← Product Name)

5-4. DIAGNOSTIC MODE
DETAILS (Continued)

Loading Report for Previous Batch of Shortening

If no products have a “failed to detect” rate of more than 5%, the controller shows:

“D9: LOADING”
“D9: LOOKED OK”
“D9: PREVIOUS OIL”

Otherwise, for each product that has more than 5% of loads in which the controller failed to detect the drop point, the following message is displayed:

“D9: PREVIOUS OIL,”
“D9: IRREGULAR”
“D9: LOADING”
“D9: FOR 6% OF”
“D9: “BRK-FIL” (← Product Name)

D 10: Non-Standard Program Items Report

The last section in the Diagnostic Report identifies how many programmable settings have been altered from their original, factory default settings.

For each of the various program modes, the controller either reports that “all settings match original values” or reports “N items do not match original values”. This report makes it easy to see if any cook parameters or other settings have been changed from CFA settings.

Some programming items may have been changed from original values under the direction of CFA corporate headquarters. In some cases, a controller should have values that don’t match original values. A report that “all items match original values” could actually be an indication that something isn’t set right.

Keep in mind also that the number of such “approved” alterations might be different for different versions of software.

If all product cook settings match the original, factory default values, the controller displays the following message:

“10: ALL PROD’S”
“10: MATCH”
“10: ORIG. VALUES”

5-4. DIAGNOSTIC MODE
DETAILS (Continued)

If any of the product settings do not match original values, the following message is displayed (with one or more of the product numbers blinking):

“10: PROD’S 123456”
“10: DO NOT MATCH”
“10: ORIG. VALUES”

In this case, the blinking numbers indicate which products do not match original settings. If the numbers 3 and 5 are the only numbers blinking, then product #3 and product #5 each have at least one setting changed from their factory preset values. Products 1, 2, 4, and 6 are confirmed to exactly match their original settings.

The second item in section 10 identifies how many items in CFA Programming Mode have been changed from their original values. These Chick-fil-A settings mainly deal with special Chick-fil-A controller features like Oil Wear, Heat-up Monitoring, New Oil Compensation, Oil Idle Compensation, Drop Detection, Clean-out Mode, and Amps and Voltage alarms.

If all items in CFA Prog. Mode match their original, factory preset values, the following report is made:

“10: ALL CFA ITEMS”
“10: MATCH”
“10: ORIG. VALUES”

If any of the items in CFA Prog. Mode do not match their original values, the following message is displayed (with the actual number of changed items):

“10: 2 CFA ITEMS”
“10: DO NOT MATCH”
“10: ORIG. VALUES”

A similar report is made for Special Program Mode. Special Program (SP) Mode settings deal with °F/°C display, speaker tone and volume, Melt and Idle Modes, and how the product buttons function (start cook or merely select product).

“10: ALL SP ITEMS”	“10: 1 SP ITEMS”
“10: MATCH”	“10: DO NOT MATCH”
“10: ORIG. VALUES”	“10: ORIG. VALUES”

5-4. DIAGNOSTIC MODE
DETAILS (Continued)

The final item in section 10 identifies if any changes have been made to the heat control settings. These settings affect the fryer's heating algorithms, and include the PC factors, rate-of-rise compensations, and heat pulse cycle time, etc.

"10: ALL HC ITEMS"

"10: MATCH"

"10: ORIG. VALUES"

"10: 3 HC ITEMS"

"10: DO NOT MATCH"

"10: ORIG. VALUES"



Henny Penny Corporation
P.O.Box 60
Eaton, OH 45320

1-937-456-8400
1-937-456-8402 Fax

Toll free in USA
1-800-417-8417
1-800-417-8434 Fax

www.hennypenny.com

* FM05 - 075 - E Henny Penny Corp., Eaton, Ohio 45320, Revised 4-20-2017