

**HENNY PENNY®**

Engineered to Last

**Henny Penny  
Evolution Elite®**

**Reduced Oil Capacity Open Fryers  
(Split Vat & Full Vat– Electric)**

**Wendy's  
Model EEE-153  
Model EEE-154**

**TECHNICAL MANUAL**



**TABLE OF CONTENTS**

<b>Section</b>	<b>Page</b>
Section 1. TROUBLESHOOTING.....	1-1
1-1 Introduction .....	1-1
1-2 Safety .....	1-1
1-3 Troubleshooting.....	1-2
1-4 Error Code Table .....	1-7
Section 2. INFO & FILTER BUTTON STATS.....	2-1
2-1 INFO Button Stats .....	2-1
2-2 FILTER Button Stats .....	2-1
Section 3. INFORMATION MODE.....	3-1
3-1 Information Mode Details .....	3-1
Section 4. Product Program Mode .....	4-1
4-1 Modifying Product Settings.....	4-1
Section 5. LEVEL 2 PROGRAMMING .....	5-1
5-1 Special Program Mode .....	5-1
5-2 Do Not Disburb .....	5-10
5-3 Clock Set .....	5-11
5-4 Data Logging, Heat Control, Tech, Stat & Filter Control Modes .....	5-11
5-5 Tech Mode .....	5-12
5-6 Stats Mode.....	5-18
Section 6. MAINTENANCE SECTION.....	6-1
6-1 Intoduction.....	6-1
6-2 Maintenance Hints.....	6-1
6-3 Preventive Maintenance .....	6-1
6-4 Control Panel and Menu Card Replacement .....	6-2
6-5 High Temperature Limit Control.....	6-3
6-6 Breakers.....	6-7
6-7 Main Power switch.....	6-8

**TABLE OF CONTENTS**

<b>Section</b>	<b>Page</b>
Section 6. MAINTENANCE SECTION (Continued)	
6-8 Temperature Probe Replacement.....	6-8
6-9 Oil Channel Clean-Out.....	6-10
6-10 Element Safety Switch .....	6-11
6-11 Contactors.....	6-12
6-12 Solenoid Valves .....	6-14
6-13 Filter Pump & Motor .....	6-16
6-14 JIB Pump .....	6-19
6-15 Express Filter PC Board .....	6-19
6-16 Transformers.....	6-20
6-17 Filter Motor Relay .....	6-21
6-18 Drain Pan Switch.....	6-22
6-19 Filter Beacon® .....	6-23
6-20 Oil Level Probes.....	6-24
6-21 Drain Rod Switch .....	6-26
6-22 Time-Delay-Relays.....	6-27
Wiring Diagrams - 208/240V .....	6-29
Section 7. PARTS SECTION	
7-1 Introduction .....	7-1
7-2 Genuine Parts .....	7-1
7-3 How To Order.....	7-1
7-4 Prices .....	7-1
7-5 Delivery .....	7-1
7-6 Warranty .....	7-1
Spare Parts Lists	

## SECTION 1. TROUBLESHOOTING

### 1-1. INTRODUCTION

This section provides troubleshooting information in the form of an easy to read table.

If a problem occurs during the first operation of a new fryer, recheck the installation per the Installation Section of this manual.

Before troubleshooting, always recheck the operation procedures per Section 3 of this manual.

### 1-2. SAFETY

Where information is of particular importance or safety related, the words DANGER, WARNING, CAUTION, and NOTICE are used. Their usage is described below.



SAFETY ALERT SYMBOL is used with DANGER, WARNING, or CAUTION which indicates a personal injury type hazard.



NOTICE is used to highlight especially important information.



*CAUTION used without the safety alert symbol indicates a potentially hazardous situation which, if not avoided, may result in property damage.*



*CAUTION indicates a potentially hazardous situation which, if not avoided, may result in minor or moderate injury.*



**WARNING indicates a potentially hazardous situation which, if not avoided, could result in death or serious injury.**



**DANGER INDICATES AN IMMINENTLY HAZARDOUS SITUATION WHICH, IF NOT AVOIDED, WILL RESULT IN DEATH OR SERIOUS INJURY.**

### **1-3. TROUBLESHOOTING**

To isolate a malfunction, proceed as follows:

1. Clearly define the problem (or symptom) and when it occurs.
2. Locate the problem in the Troubleshooting table.
3. Review all possible causes. Then, one-at-a-time work through the list of corrections until the problem is solved.
4. Refer to the maintenance procedures in the Maintenance Section to safely and properly make the checkout and repair needed.



**If maintenance procedures are not followed correctly, injuries and/or property damage could result.**

Problem	Cause	Correction
<b>POWER SECTION</b>		
<p>With power switch in ON position, the fryer is completely inoperative</p> <p>(NO POWER)</p>	<ul style="list-style-type: none"> <li>• Open circuit</li> </ul>	<ul style="list-style-type: none"> <li>• Check to see that unit is plugged in</li> <li>• Check the breaker or fuse at supply box</li> <li>• Check voltage at wall receptacle</li> <li>• Check MAIN POWER switch; replace if defective</li> <li>• Check cord and plug</li> <li>• Check circuit breakers in fryer</li> </ul>
<b>HEATING OF SHORTENING SECTION</b>		
<p>Oil will not heat</p>	<ul style="list-style-type: none"> <li>• Blown fuse or tripped</li> <li>• Faulty power switch.</li> <li>• Faulty cord and plug</li> <li>• Faulty drain switch</li> <li>• Faulty PC Board</li> <li>• High limit control switch tripped</li> </ul>	<ul style="list-style-type: none"> <li>• Reset breaker or replace fuse circuit breaker at supply box or control panel</li> <li>• Check power switch per maintenance section on the power switch</li> <li>• Check cord and plug</li> <li>• Check power at receptacle</li> <li>• Check drain switch per maintenance section on drain switches</li> <li>• Remove and replace control panel</li> <li>• Reset the high limit by using a small screwdriver or Allen wrench, gently pushing it into the hole in the heating element hinge; if high limit does not reset, high limit must be replaced</li> </ul>



Problem	Cause	Correction
<b>HEATING OF SHORTENING SECTION (Continued)</b>		
Oil will not heat (Continued)	<ul style="list-style-type: none"> <li>• Drain valve open</li> <li>• Possible faulty temperature probe</li> <li>• Faulty contactor</li> <li>• Breaker on fryer tripped</li> </ul>	<ul style="list-style-type: none"> <li>• Close drain valve</li> <li>• Replace temperature probe</li> <li>• Check contactor per maintenance section on contactors</li> <li>• Check breakers on fryer per maintenance section on breakers</li> </ul>
Oil heating too slow	<ul style="list-style-type: none"> <li>• Low or improper voltage</li> <li>• Weak or burnt out element(s)</li> <li>• Points in contactor bad</li> <li>• Wire(s) loose</li> <li>• Burnt or charred wire connection</li> </ul>	<ul style="list-style-type: none"> <li>• Use a meter and check the receptacle against data plate</li> <li>• Check heating element(s) per Element Replacement Section</li> <li>• Check contactor per Contactor Replacement Section</li> <li>• Tighten</li> <li>• Replace wire and clean connectors</li> </ul>
Oil overheating	<ul style="list-style-type: none"> <li>• Programming wrong</li> <li>• Faulty PC board</li> <li>• Faulty temperature probe</li> <li>• Check contactor for not opening</li> </ul>	<ul style="list-style-type: none"> <li>• Check temperature setting in the program mode</li> <li>• Replace control board if heat indicator stays on past ready temperature</li> <li>• Check probe calibration and replace if temperature is off <math>\pm 5</math> degrees</li> <li>• Check faulty contactor per Contactor Replacement Section</li> </ul>

Problem	Cause	Correction
<b>OIL LEVEL SECTION</b>		
Oil foaming or boiling over vat	<ul style="list-style-type: none"> <li>• Water in oil</li> <li>• Improper or bad oil</li> <li>• Improper filtering</li> <li>• Bottom of vat full of crumbs</li> <li>• Improper rinsing after cleaning the fryer</li> </ul>	<ul style="list-style-type: none"> <li>• At end of a Cook Cycle, drain vat and clean vat; add fresh oil</li> <li>• Use recommended oil</li> <li>• Refer to the procedure covering filtering the oil</li> <li>• Filter oil</li> <li>• Rinse the vat thoroughly to remove any cleaning agent in the vat</li> </ul>
Oil will not drain from vat	<ul style="list-style-type: none"> <li>• Drain valve clogged with crumbs</li> <li>• Oil channel clogged</li> </ul>	<ul style="list-style-type: none"> <li>• Open valve, force cleaning brush through drain</li> <li>• Access the clean-out plug on the sides of the unit (see Oil Channel Clean-out Section)</li> </ul>
Oil leaking through drain valve	<ul style="list-style-type: none"> <li>• Obstruction in drain</li> <li>• Faulty drain valve</li> </ul>	<ul style="list-style-type: none"> <li>• Remove obstruction</li> <li>• Replace drain valve</li> </ul>
Vat is under-filled	<ul style="list-style-type: none"> <li>• JIB is low or empty</li> <li>• JIB oil line is clogged or collapsed</li> <li>• Filter pan needs cleaned</li> </ul>	<ul style="list-style-type: none"> <li>• Fill the JIB</li> <li>• Check JIB line</li> <li>• Clean filter pan and change pad</li> </ul>
Bubbles in oil during entire filtering process	<ul style="list-style-type: none"> <li>• Filter pan not completely engaged</li> <li>• Filter pan clogged</li> <li>• Damaged o-ring on filter line tube on fryer</li> </ul>	<ul style="list-style-type: none"> <li>• Make sure filter pan return line is pushed completely into the receiver on the fryer</li> <li>• Clean pan and change pad</li> <li>• Change O-ring</li> </ul>

Problem	Cause	Correction
<b>FILTER MOTOR SECTION</b>		
Filter motor runs but pumps oil slowly	<ul style="list-style-type: none"> <li>• Filter line connections loose</li> <li>• Filter paper or pad clogged</li> </ul>	<ul style="list-style-type: none"> <li>• Tighten all filter line connections</li> <li>• Change filter paper or pad</li> </ul>
Filter motor will not run	<ul style="list-style-type: none"> <li>• the thermal reset button on the rear of the pump motor is tripped</li> </ul>	<ul style="list-style-type: none"> <li>• Allow time for the motor to cool and then, using a screw driver, press hard against the button until it clicks</li> </ul> <div data-bbox="1052 659 1403 1062" style="text-align: center;"> </div>
<b>DISPLAYED PROMPT SECTION</b>		
“IS POT FILLED” filter error prompt	<ul style="list-style-type: none"> <li>• All oil did not completely return after a filter cycle</li> <li>• Filter pad clogged</li> </ul>	<ul style="list-style-type: none"> <li>• Have manager follow prompts</li> <li>• Is JIB full? If not, fill JIB</li> <li>• Replace filter pad/clean pan.</li> </ul>
“CHECK PAN” prompt	<ul style="list-style-type: none"> <li>• Filter pan not completely engaged</li> </ul>	<ul style="list-style-type: none"> <li>• Adjust filter pan</li> </ul>
“FILTER PAN MISSING” prompt appears	<ul style="list-style-type: none"> <li>• Filter pan missing</li> <li>• Filter pan interlock not engaged</li> </ul>	<ul style="list-style-type: none"> <li>• Find pan and replace</li> <li>• Adjust filter pan to engage interlock</li> </ul>
“CHANGE FILTER PAD” prompt appears	<ul style="list-style-type: none"> <li>• Filter pad has not been changed within a 24hr time period; Main power switch was turned off during filter pad change</li> <li>• Drain pan microswitch stuck</li> </ul>	<ul style="list-style-type: none"> <li>• Replace old filter pad with NEW filter pad with main power switch turned on. *NOTE* 24/7 store replace filter twice a day.</li> <li>• Check microswitch</li> </ul>

**1-4. ERROR CODES**

In the event of a control system failure, the digital display shows an error message. The message codes are shown in the DISPLAY column below. A constant tone is heard when an error code is displayed, and to silence this tone, press any button.

<u>DISPLAY</u>	<u>CAUSE</u>	<u>CORRECTION</u>
"E-4"	Control board overheating	Turn switch to OFF position, then turn switch back to ON; if display shows "E-4", the control board is getting too hot; check the louvers on each side of the unit for obstructions
"E-5"	Oil overheating	Turn switch to OFF position, then turn switch back to ON; if display shows "E-5", the heating circuits and temperature probe should be checked
"E-6A"	Temperature probe open	Turn switch to OFF position, then turn switch back to ON; if display shows "E-6A", the temperature probe should be checked
"E-6B"	Temperature probe shorted	Turn switch to OFF position, then turn switch back to ON; if display shows "E-6B", the temperature probe should be checked
"E-10"	High limit	Let unit cool down (15-20 minutes), using the high limit tool on the inside of the LH door and gently pushing it into the hole in the heating element hinge; if high limit does not reset, high limit must be replaced  
"E-15"	Drain switch	Make sure drain knob is completely pushed-in; if E-15 persists, have drain switch checked
"E-18-A" "E-18-B" "E-18-C"	Left level sensor open Right level sensor open Both level sensors open	Turn switch to OFF position, then turn switch back to ON; if display still indicates a failed sensor, have the connections checked the control board; have sensor checked & replaced if necessary

**1-4. ERROR CODES (Continued)**

<b><u>DISPLAY</u></b>	<b><u>CAUSE</u></b>	<b><u>CORRECTION</u></b>
"E-21"	Slow heat recovery	Have a certified service technician check the fryer for correct voltage to the unit; have heat circuit checked; have unit checked for loose or burnt wire
"E-22" "NO HEAT" "CHECK PWR CORD AND BREAKER"	Elements not	Have power cord and heat circuit checked heating
"E-31"	Elements are up	Lower elements completely back into the vat
"E-41", "E-46"	Programming	Press power button to vat off and back on again, if any failure of the error codes, have the controls reinitialized; if error code persists, have the control board replaced
"E-47"	Analog converter chip or 12 volt supply failure	Press power button to vat off and back on again, if "E-47" persists, have the I/O board, or the PC board replaced; if speaker tones are quiet, probably I/O board failure; have the I/O board replaced
"E-48"	Input system error	Have PC board replaced
"E-54C"	Temperature input	Turn switch to OFF, then back to ON; have control PC error board replaced if "E-54C" persists
"E-60"	AIF PC board not communicating with control PC board	Press power button to turn vat off, wait 15 seconds, and turn back on again. If "E-60" persists, have connector between the PC boards checked; replace AIF PC board or control PC board, if necessary
"E-93-A" "24 VDC SUPPLY TRIPPED"	Autolift motor malfunction or failure	If AutoLift feature is not operating, have each of the Autolift motors checked

## SECTION 2. INFO & FILTER BUTTON STATS

### 2-1. INFO BUTTON STATS

#### Actual Oil Temperature

1. Press  and the actual oil temperature shows in the display, for each vat.

#### Set-point Temperature

2. Press  twice and SP shows in the display, along with the set-point (preset) temperature of each vat.

#### Recovery Information for each Vat

1. Press  3 times and REC shows in the left display and the recovery time that oil temperature went from 250°F (121°C) to 300°F (149°C) shows in the right display. For example, 

REC	5:30
-----	------

 means it took 5 minutes and 30 seconds for the oil temperature to recover to 300°F (149°C) from 250°F (121°C).

### NOTICE

If no buttons are pressed within 5 seconds in any of stats modes, the controls revert back to normal operation.

### 2-2. FILTER BUTTON STATS

#### Cook Cycles Remaining before Filtering

1. Press and release either  button and the left display shows “COOKS REMAINING” and the right display shows the number of cook cycles before the next auto filter. For example, 

REMA	INING	3	6
------	-------	---	---

 means after 3 more cook cycles on the left vat, the controls asks the operator if they are ready to filter or not. But, 6 more cook cycles remain on the right vat.

#### Time and Date

2. Press either  twice and ‘FILTERED’ shows in the displays, along with the time-of-day and date of the last filter.

## SECTION 3. INFORMATION MODE

This historic information can be recorded and used for operational and technical help and allows you to view the following:



- 1. E-LOG
- 2. LAST LOAD
- 3. DAILY STATS
- 4. OIL STATS
- 5. REVIEW USAGE
- 6. INPUTS
- 7. OUTPUTS
- 8. OIL TEMP
- 9. CPU TEMP
- 10. COMMUNICATION INFO
- 11. ANALOG INFO
- 12. ACTIVITY LOG
- 13. OIL LEVELS
- 14. PUMP VALVE INFO
- 15. AIF INFO

### NOTICE

Not all Information Mode functions are discussed in this section. To ensure proper operation of fryer, please consult Henny Penny Corp. before changing any of these settings. For more information on these functions, contact Technical Support at 1-800-417- 8405, or 1-937-456-8405.

### 3-1. INFORMATION MODE DETAILS

#### 1. E-LOG (error code log)

Press  and  buttons at the same time and “\*INFO MODE\*” shows in the display, followed by “1. E-LOG”.

### NOTICE

Press  and  to exit Information Mode at any time.

Press  and “A. (date & time) \*NOW\* show in displays. This is the present date and time.

Press  and if a error was recorded, “B. (date, time, and error code information)” shows in display. This is the latest error code that the controls recorded.



Press  and the next latest error code information can be seen.

Up to 10 error codes (B to K) can be stored in the E-LOG section.

**3-1. INFORMATION MODE**  
**DETAILS (Continued)**

**2. LAST LOAD** (Information on recent cook cycles)

Press  and “2. LAST LOAD” show in displays.

Press a timer button  or  for the product you want to view the cook data and the LED flashes.

Press  button to start viewing the cook data.

For example, if the left  LED is flashing, “PRODUCT FRY L1” show in displays.

If the right  LED is flashing, “PRODUCT FRY R2” show in displays.

Press  button to start viewing the cook data.

**FUNCTION**

**DISPLAY EX:**

Product (Last product cooked)	PRODUCT	FRY L1
Time of day the last Cook Cycle was started	STARTED	FEB 4 2:25P
Actual Elapsed cook Time (Real seconds)	ACTUAL TIME	1:06
Programmed cook Time	PROG TIME	1:00
Max Temp during Cook Cycle	MAX TEMP	350°F
Min Temp during Cook Cycle	MIN TEMP	313°F
Avg Temp during Cook Cycle	AVG TEMP	322°F
Heat On (percentage) during Cook Cycle	HEAT ON	45%
Ready? (Was fryer Ready before start?)	READY?	YES
When Cook Cycle was stopped: Early	QUIT AT	0:10 REM
		OR
After complete Cook Cycle	*DONE*	+6 SEC
Difference (%) between actual and programmed cook time	ACT/PROG	1%

**3-1. INFORMATION MODE**  
**DETAILS (Continued)**

**3. DAILY STATS** (Operational info of fryer for last 7 days)

Press  and “3. DAILY STATS” show in displays.

Press  button to start viewing the cook data.

Press the right  to view data for other days of week.

**FUNCTION**

**DISPLAY EX:**

Day this data was recorded for	APR-30	TUE*
Number of Hours:Minutes the fryer was on	(L/R) ON HRS	TUE* 3:45
Number of times filtered	(L/R) FILTERED	TUE* 4
Number of times filter skipped	(L/R) SKIPPED	TUE* 4
Number of times oil added	(L/R) ADD OIL	TUE* 4
Number of times oil discarded	(L/R) DISPOSE	TUE* 0
Oil temperature recovery time	(L/R) RECOVERY	TUE*1:45
Total number of cook cycles that day	(L/R) TOT CK	TUE* 38
Number of cycles stopped before *DONE*	QUIT CK	TUE* 2
Cook Cycles for Product #1	TUE* COOK -1-	17
Cook Cycles for Product #2	TUE* COOK -2-	9
Cook Cycles for Product #3	TUE* COOK -3-	5
Cook Cycles for Product #4	TUE* COOK -4-	0
Cook Cycles for Product #5	TUE* COOK -5-	0
Cook Cycles for Product #6	TUE* COOK -6-	6
Cook Cycles for Product #7	TUE* COOK -7-	0
Cook Cycles for Product #8	TUE* COOK -8-	0
Cook Cycles for Product #9	TUE* COOK -9-	1
Cook Cycles for Product #0	TUE* COOK -0-	0

**3-1. INFORMATION MODE**  
**DETAILS (Continued)**

**4. OIL STATS** (info of current oil and avg. of last 4 batches of oil)

Press  and “4. OIL STATS” show in displays.

Press  button to start viewing the cook data.

**FUNCTION**

**DISPLAY EX:**

Start date of new oil	NEW OIL	MAR-23
Number of days oil in use	(L/R) OIL USE	4 DAYS
Number of filters on this oil	(L/R) FILTERED	4
Number of times filter skipped	(L/R) SKIPPED	0
Number of cook cycles on this oil	(L/R) TOT CK	38
Average number of days per oil change	(L/R) AVG DAYS PER OIL CHANGE	13.8 DAYS
Average number cook cycles per oil change	(L/R) AVG CKS PER OIL CHANGE	388 CKS

Press and hold a product button (1 to 4) to view the data from one of the previous 4 batches of oil used.

Press  to view oldest oil data: Ex: OIL-4 14 DAYS

Press  to view 3rd oldest oil data: Ex: OIL-3 12 DAYS

Press  to view 2nd oldest oil data: Ex: OIL-2 15 DAYS

Press  to view previous batch of oil: Ex: OIL-1 13 DAYS

**NOTICE**

To obtain the most accurate oil information, use the “3.DISPOSE” step in the Filter Menu (press and hold ) to drain the oil from the vat.

**3-1. INFORMATION MODE**  
**DETAILS (Continued)**

**5. REVIEW USAGE**(accumulated info since the data was reset)

Press  and “5. REVIEW USAGE” show in displays.

Press  button to start viewing the cook data.

**FUNCTION**

**DISPLAY EX:**

Day the usage data was previously reset	SINCE	APR-19 3:00P
Number of Hours the fryer was on	(L/R) ON HRS	4
Number of times filtered	(L/R) FILTERED	4
Number of times filter skipped	(L/R) SKIPPED	0
Number of times oil added	(L/R) ADD OIL	4
Number of times oil discarded	(L/R) DISPOSE	1
Total number of cook cycles	(L/R) TOT CK	38
Number of cycles stopped before *DONE*	QUIT CK	2
Cook Cycles for Product #1	COOK -1-	17
Cook Cycles for Product #2	COOK -2-	9
Cook Cycles for Product #3	COOK -3-	5
Cook Cycles for Product #4	COOK -4-	0
Cook Cycles for Product #5	COOK -5-	0
Cook Cycles for Product #6	COOK -6-	6
Cook Cycles for Product #7	COOK -7-	0
Cook Cycles for Product #8	COOK -8-	0
Cook Cycles for Product #9	COOK -9-	1
Cook Cycles for Product #0	COOK -0-	0
<b>Reset usage data:</b> Enter the Usage Code - 1, 2, 3 on this step to zero out all the usage information	RESET USAGE / ENTER CODE	-----

**3-1. INFORMATION MODE**  
**DETAILS (Continued)**

**6. INPUTS**

Press  and “6. INPTS” and “HDE” show in displays.

H = HIGH LIMIT - If “H” is present, the high limit is good. If “-” shows then the high limit is tripped out (overheated) or disconnected.

D = DRAIN SWITCH - If “D” is present, the drain handle (when applicable) is closed. If “-” shows then the drain is open or the switch is faulty.

E = ELEMENT SWITCH - If “E” is present, the element switch is good. If “-” shows in the display, the element is in the upright position, or the switch is faulty.

Press  button and an underscore (“\_”) indicates the input is not presently detected. A Checkmark (“√”) indicates the signal is detecting a normal input. A blinking (“X”) indicates the signal is presently detected, but is detected as a half-wave (partially failed) input.

**NOTICE**



The H, D, E signals above are wired in series. The first signal missing out of this sequence generally causes all signals to the right of it to be missing as well.

**7. OUTPUTS**

Press  and “7. OUPTS” and “S-H-” show in displays.

S = SAFETY CONTACTOR - Press  to turn off and on the safety (primary) contactor

H = HEAT CONTACTOR - Press  to turn off and on the heat contactor.

( turns off and on the safety (primary) contactor for the left vat of a split vat fryer, and  turns off and on the heat contactor.)

**8. OIL TEMPERATURE**

Press  and “8.OIL TMP” shows in the left display and the oil temperature shows in the right display.

**9. CPU TEMPERATURE**

Press  and “9.CPU TMP” shows in the left display and the current PC board temperature shows in the right display.



## SECTION 4. PRODUCT PROGRAM MODE

This mode allows you to program the following:

- |                       |                                    |
|-----------------------|------------------------------------|
| • Change Product Name | • Include in Filter Count (Global) |
| • Assign Button       | • Filter at X no. of loads (Mixed) |
| • Change Times & Temp | • Load Compensation                |
| • Change Cook ID      | • Load Compensation Reference      |
| • Alarms              | • Full Heat                        |
| • Quality Timers      | • PC Factor                        |

### 4-1. MODIFYING PRODUCT SETTINGS

1. Press and hold **P** button until “PROG” shows in the display, followed by “ENTER CODE”.
2. Enter code 1, 2, 3 (first 3 product buttons). “PRODUCT” and “PROGRAM” show in the displays, followed by “SELECT PRODUCT” and “-P 1-” (ex: NUG).

#### **Change Product Names**

3. Use the ▲ and ▼ buttons to scroll through the 40 products, or press the desired product button.
4. Press ► button and “NAME” shows in the left display and the product (ex: NUGGETS) shows in the right display.
5. Press √ button and the first letter in the name flashes. Press a product button and the flashing letter changes to the first letter under the product button that was pressed. For example, if  is pressed, the flashing letter changes to an “A”.

Press the same button again and the flashing letter changes to a “B”. Press it again and the flashing letter changes to a “C”. Once the desired letter shows in the display, press ► button to continue to the next letter and repeat the procedure.





Press and hold the right X button to exit Program Mode, or press ► button to continue on to “COOK TIME”.



#### **Assign Button**

6. Press ► button until “ASSIGN BTN” shows in the display, along with the product (ex: NUGGETS). If this product already has a product button assigned to it, that LED will be lit. To assign other product buttons to that product, press and hold the product button for 3 seconds and that LED stays lit. To remove a product from a button, press and hold the product button with a lit LED and the LED goes out.



## **4-1. MODIFYING PRODUCT SETTINGS (Continued)**

### **To Change Times and Temperatures**



7. Press  button until “COOK TIME” shows in the display, and then use the product buttons, or the  and  buttons, to change the time in minutes and seconds, to a maximum of 59:59.
8. Press  button and “TEMP” shows in the display, along with the preset temperature on the right side of the display.

Press the product buttons, or the  and  buttons, to change the temperature. The temperature range is 190°F (88°C) to 375°F (191°C).

### **Cook ID Change**

9. Press  button until “COOK ID” shows in the display along with the product ID. For example, NUG would be the ID for nuggets. Use the product buttons, or the  and  buttons, to change the ID.



### **Alarms (1 & 2)**

11. Press  button until “ALRM 1” shows in the left display, and an alarm time in the right display. Press the product buttons, or the  and  buttons, to set an alarm.

Ex., If a Cook Cycle was set at 3 minutes, and an alarm was to go off after 30 seconds into the Cook Cycle, “2:30” would be set in the display at this time. When the timer counts down to 2:30 the alarm sounds.



After the alarm time is set, press  button and “ALRM 2” shows in the display, and a second alarm can be programmed.

### **Quality Timer (hold time)**

12. Press  button until “QUAL TMR” shows in the display along with the preset holding time. Press the product buttons, or the  and  buttons, to adjust holding time, up to 59:59.

### **Global Filter Tracking**



#### **Include in Filter Count**

- 13a. Press  button until “INCL IN FLTR CNT” flashes in the display along with “YES” or “NO”. Using  and  buttons, change the display to “YES” if that product’s Cook Cycles are to be counted as part of the recommended filter process. Set to “NO” if it is not to be included.

**4-1. MODIFYING PRODUCT SETTINGS (Continued)**



Mixed Filter Tracking



**Filter After X Number of Loads**



13b. Press  button until “FILTER AFTER...” flashes in the left display along, and the number of cook cycles between filters shows in the right display. Press the product buttons, or the  and  buttons, to change this value of 0 to 99 loads. This needs set for each product.



**>Load Compensation, Load Compensation Reference, Full Heat, PC Factor<**

14. Press  button until “LD COMP” shows in the display, along with the load compensation value. This automatically adjusts the time to account for the size and temperature of the cooking load.



Press the product buttons, or the  and  buttons, to change this value of 0 to 20.

15. Press  button until “LCMP REF” shows in the display along with the load compensation average temperature. (if load compensation is set to “OFF”, then “\_ \_ \_” shows in display and setting cannot be programmed) This is the average cooking temperature for each product. The timer speeds up at temperatures above this setting and slows down at temperatures below this setting. Press the product button, or the  and  buttons, to change this value.

16. Press  button until “FULL HT” shows in the display along with the full heat value in seconds, which means the heat is on as soon as a timer button is pressed, for the programmed length of time. Press the product buttons, or the  and  buttons, to change this value of 0 to 90 seconds.

17. Press  button until “PC FACTR” shows in the display along with the proportional temperature, which helps to keep the oil from over-shooting the setpoint temperature. Press the product buttons, or the  and  buttons, to change this value of 0 to 50 degrees.

**NOTICE**

- Use  button to go back to previous menu items.
- Press  button when finished with the current product, to return to the “SELECT PRODUCT” step.
- Press and hold  button to exit PRODUCT PROGRAM Mode.

## SECTION 5. LEVEL 2 PROGRAMMING

- Used to access the following:
- Special Program Mode
  - Clock Set
  - Data Communication
  - Heat Control
  - Tech Mode
  - Stats
  - Filter Control

### 5-1. SPECIAL PROGRAM MODE

The Special Program Mode is used to set more detailed programming, such as:

- SP-1** • Degrees Fahrenheit or Celsius
- SP-2** • Language: English, Russian, Swedish (SVENSKT), German (DEUTSCHE), Portuguese, Spanish (ESPANOL) and French (FRANCAIS)
- SP-3** • System Initialization (Factory Presets)
- SP-4** • Audio Volume
- SP-5** • Audio Tone
- SP-6** • Melt Cycle Select - 1.LIQUID; 2.SOLID
- SP-7** • Idle Mode Enabled - YES or NO
- SP-7A** • Use “0” for IDLE
- SP-7B** • Auto Idle Minutes
- SP-7C** • Idle Set-point Temperature
- SP-8** • Filter Tracking Mode - 1.MIXED or 2.GLOBAL
- SP-8A** • Suggest Filter At... - 75% to 100% (**MIXED**)
- SP-8B** • Filter Lockout Enabled? - YES or NO (**MIXED**)
- SP-8A** • Left Vat Filter Cycles - 0 to 99 (**GLOBAL**)
- SP-8B** • Right Vat Filter Cycles - 0 to 99 (**GLOBAL**)
- SP-8C** • Filter Lockout Enabled? - YES or NO (**GLOBAL**)
- SP-9** • Polish Duration - X:XX M:SS
- SP-10** • Change Pad Reminder Time - XX HRS
- SP-11** • Clean-Out Time - XX MIN
- SP-12** • Clean-Out Temperature - XXX °F or °C
- SP-13** • Cooking User IO - After Cook Cycle, display shows previous menu item or “----”
- SP-14** • Number of Baskets - 2-BASKETS or 4 BASKETS
- SP-15** • Show Cooking Indicator - YES or NO
- SP-16** • 2nd Language: English, Russian, Swedish (SVENSKT), German (DEUTSCHE), Portuguese, Spanish (ESPANOL) and French (FRANCAIS)
- SP-17** • 2nd AudioVolume
- SP-18** • Energy Save Enabled? - YES or NO
- SP-19** • Fryer Type - GAS or ELECTRIC
- SP-20** • Vat Type - SPLIT or FULL
- SP-21** • Autolift Enabled? - NO LIFT or YES LIFT
- SP-22** • Bulk Oil Supply? - YES or NO
- SP-23** • Bulk Oil Dispose? - YES or NO
- SP-24** • Serial No. of Fryer
- SP-25** • Change Mgr. Code- 1 = YES
- SP-26** • Change Usage Code - 1 = YES
- SP-27** • Dispose Requires Code ? - YES or NO
- SP-28** • Longer Fill Time Enabled - YES or NO
- SP-29** • Let User Exit Fill? - YES or NO
- SP-30** • Skip ‘SKIM’ Prompt? - YES or NO
- SP-31** • 2-Stage Wash Enabled? - YES or NO

## **5-1. SPECIAL PROGRAM MODE (Continued)**

Press and hold the **P** button for 5 seconds until “LEVEL 2” followed by, “SP PROG” and “ENTER CODE” show in the display.

Enter code 1,2,3, and “SP-1”, “TEMP”, “FORMAT” show in the displays.

### **NOTICE**

If a bad code is entered, a tone sounds and “BAD CODE” shows on the display. Wait a few seconds, the controls revert back to the cook mode, and repeat the above steps.

To exit from the Special Program Mode at any time, press and hold **P** button for 2 seconds.

### **Degrees Fahrenheit or Celsius (SP-1)**

The left display flashes “SP-1” and “TEMP”, “FORMAT”. Press the ▲ or ▼ buttons to choose °F or °C.

### **NOTICE**

- Use ◀ button to go back to previous menu items
- Press ▶ button when finished with the current Level 2 step

### **Language (SP-2)**

Press ▶ button and “SP-2” and “LANGUAGE” flash on the left display. Press the ▲ or ▼ buttons to select the desired language.

### **System Initialization (SP-3)**



Press ▶ button and “SP-3” and “DO SYSTEM INIT” flash in the display, along with “INIT” on the right display. To reset the controls to factory default settings, press and hold √ button and control counts down “IN 3”, “IN 2”, “IN 1”. Once display shows “-INIT-” & \*DONE\* the controls are reset to factory defaults.

### **Audio Volume (SP-4)**

Press ▶ button and “SP-4” and “VOLUME” flash in the left display. Press the ▲ or ▼, or use product buttons, to adjust the volume of the speaker, 10 being the maximum value and 1 the minimum.



**5-1. SPECIAL PROGRAM  
MODE (Continued)**

**Audio Tone (SP-5)**

Press  button and “SP-5” and “TONE” flash in the left display. Press the  or , or use product buttons, to adjust the tone of the speaker, 2000 being the maximum value and 50 the minimum.



**Liquid or Solid Cooking Oil Used (SP-6)**





Press  button until “SP-6 MELT CYCLE SELECT” scrolls in the left display. Unless solid oil is being used in the vats the right display should show “1.LIQUID”.



If solid oil is used, the unit **MUST BE** equipped to handle solid oil. Use the  and  buttons to change the right display to “2.SOLID”

**Idle Mode Enabled (SP-7)**



An Idle Mode allows the oil temperature to drop to a lower temperature when not in use. This saves on oil and utilities.

Press  button and “SP-7” and “IDLE MODE ENABLED?” flash in the left display. Press the  or  buttons to choose “YES” or “NO”.

With “YES” in the display, press  button and “SP-7A” and “USE ‘0’ FOR IDLE” flash on the left display. Press the  or  buttons to select “YES” or “NO”. If “YES” is selected, an Idle Mode can be programmed in product button .

Press  button and “SP-7B” and “AUTOIDLE MINUTES” flash in the left display. Press the  or  or use product buttons, to set the time (0 to 60 minutes) fryer stays idle before the auto-idle is enabled.

Ex., “30” means, if product is not cooked in that vat for 30 minutes, the control automatically cools the oil down to the idle setpoint temperature

Press  button and “SP-7C” and “IDLE SETPT” flash in the left display. Press the  or , or use product buttons, to set the idle temperature 200° to 375 °F (93 to 191 °C).

**5-1. SPECIAL PROGRAM  
MODE (Continued)**

Product	No. Cook Cycles	Cycle Count
Fish	2	1/2
French Fries	8	1/8
Chicken	4	1/4

**Filter Tracking Mode (SP-8)**

Filter Tracking signals the operator when the oil needs filtering by counting the number Cook Cycles between filters.

Press **▶** button and “SP-8” and “FILTER TRACKING MODE” show in the display. Use the **▲** and **▼** buttons to choose either “1.MIXED” filter tracking or “2.GLOBAL”.

**NOTICE**

GLOBAL means all the products have the same number of cook cycles between filters.

MIXED means each product may be set with different number of cook cycles between filters. The controls adds the cycle counts (see example at left) and when the counts equal 1 or greater, filtering is suggested. Ex: 1 load of fish, 2 loads of french fries, a load of chicken equals 1.  
 $1/2 + 1/8 + 1/8 + 1/4 = 1.$

**MIXED**

If MIXED is selected, press **▶** button and “SP-8A” and “SUGGEST FILTER AT ...” shows in the left display, and a value between 75% and 100% shows on the right display. Press the **▲** and **▼** buttons to change this value.

The lower the value, the sooner the control recommends to filter. Ex: If set to 75%, the control suggest filtering after 3/4 of the programmed cook cycles is met, whereas at 100%, all the cook cycles must be completed before the control suggest filtering.

Press **▶** and “SP-8B” and “LOCKOUT ENABLED?” shows in the left display. Press the **▲** and **▼** buttons to choose YES or NO.

If set to YES, when the controls suggest filtering, “FILTER LOCKOUT”/”YOU \*MUST\* FILTER NOW”, shows in the display, and it refuses further cook cycles until the vat is filtered.

Press **▶** and “SP-8C” and “LOCKOUT AT...” shows in the left display and a value between 100% and 250% shows on the right display. Press the **▲** and **▼** buttons to change this value. The lower the value, the sooner the “lockout” occurs.

Ex: If set at 100%, “lockout” occurs when the cycle counts reaches 1 or greater. Set at 200%, twice as many cycles are counted before “lockout” occurs. See example above.

**5-1. SPECIAL PROGRAM  
MODE (Continued)**

**Filter Tracking Mode (SP-8) (Continued)**

**GLOBAL**

If GLOBAL is selected, press ► button.

**Split Vat**

If unit is a split vat, “SP-8A” and “LEFT VAT FILTER CYCLES” shows in the left display, and the number of cook cycles between filters shows on the right display (0 to 99). Use ▲ and ▼ to change this number.

Press ► button and “SP-8B” and “RIGHT VAT FILTER CYCLES” shows in the left display, and the number of cook cycles between filters shows on the right display (0 to 99).

Press ► button and “SP-8C” and “LOCKOUT ENABLED?” shows in the left display. Press the ▲ and ▼ buttons to choose YES or NO.

If set to YES, when the controls suggest filtering, “FILTER LOCKOUT?”/“YOU \*MUST\* FILTER NOW”, shows in the display, and it refuses further cook cycles until the vat is filtered.

**Full Vat**

If unit is a full vat, “SP-8A” and “FULL VAT FILTER CYCLES” shows in the left display, and the number of cook cycles between filters shows on the right display (0 to 99). Use ▲ and ▼ to change this number.

Press ► button and “SP-8C” and “LOCKOUT ENABLED?” shows in the left display. Press the ▲ and ▼ buttons to choose YES or NO.

If set to YES, when the controls suggest filtering, “FILTER LOCKOUT?”/“YOU \*MUST\* FILTER NOW”, shows in the display, and it refuses further cook cycles until the vat is filtered.

**5-1. SPECIAL PROGRAM**  
**MODE (Continued)**

**Polish Duration (SP-9)**

Press ► button and “SP-9 POLISH TIME” flashes in the left display. Press the ▲ or ▼ , or use product buttons, to change polish time, from 0 to 10 minutes.

**Change Filter Pad Reminder Time (SP-10)**

Press ► button and “SP-10 CHANGE PAD REMINDER” flashes in the left display. Press the ▲ or ▼ , or use product buttons, to change the time from 0 to 100 hours.

**Clean-Out Time (SP-11)**

Press ► button and “SP-11 CLEAN-OUT TIME” flashes in left display. Press the ▲ or ▼ , or use product buttons, to change the time from 0 to 99 minutes.

**Clean-Out Temperature (SP-12)**

Press ► button and “SP-12 CLEAN-OUT TEMP” flashes in the left display. Press the ▲ or ▼ , or use product buttons, to change the temperature from 0 to 195° F (90° C).

**Cooking User IO (SP-13)**

Press ► button and “SP-13 COOKING USER IO” flashes in the display. Press the ▲ or ▼ buttons to choose “SHOWPREV” or “SHOW----”.

Setting SP-13 to SHOWPREV means after a cook cycle the display shows the last menu item cooked. SHOW---- means after a cook cycle “----” shows in the display and a menu item needs selected before starting the next cook cycle.

**Number of Baskets (SP-14)**



Press ► button and “SP-14 NUMBER OF BASKETS” flashes in the left display. Press the ▲ or ▼ buttons to choose 2 or 4 baskets per well.

**Cooking Indicator (SP-15)**

Press ► button and “SP-15 SHOW COOKING INDICATOR” flashes in the left display. Press the ▲ or ▼ buttons to choose YES, and during a cook cycle, “\*” shows which timer is counting-down. Choose NO and “\*” will not show during a cook cycle.

## **5-1. SPECIAL PROGRAM MODE (Continued)**



### **2nd Language (SP-16)**

Press  button and “SP-16 2ND LANGUAGE” flashes on the left display. Press the  or  buttons to select the desired 2nd language.

By setting a 2nd language in the controls, 2 languages can now be chosen by pressing  button during normal operation.

One language shows in the left display and the second language shows in the right display. Pressing the  button selects the language in the displays.



### **2nd Volume (SP-17)**

Press  button and “SP-17 2ND VOLUME” flashes on the left display. Press the  or  buttons, or the product buttons to select the desired 2nd volume.

By setting a 2nd volume in the controls, 2 volumes can now be chosen by pressing  button twice during normal operation.



One volume setting shows in the left display (NONE to 10; 10 being the loudest) and the second volume shows in the right display. To select the volume, press the  button under the desired volume .

### **Engery Save Mode (SP-18)**



Press  button and “SP-18 ENERGY SAVE EN-ABLED?” flashes in the left display. Press the  or  buttons to choose “YES” or “NO”.

If set to YES, during times of non-use the fryer automatically starts an Energy Save Mode, which turns-off the blowers. Then once a product is selected to start a cook cycle, the blowers and heat come back on. If set to NO, the blowers are on constantly.

### **Fryer Type (SP-19)**



Press  button and “SP-19 FRYER TYPE” flashes in the left display. Press the  or  buttons to choose “GAS” or “ELEC”.

### **Vat Type (SP-20)**

Press  button and “SP-20 VAT TYPE” flashes in the left display. Press the  or  buttons to choose “SPLIT” or “FULL”.



## **5-1. SPECIAL PROGRAM MODE (Continued)**

### **Autolift Enabled (SP-21)**

Press  button and “SP-21 AUTOLIFT ENABLED?” flashes in the left display. Press the  or  buttons to choose “YES LIFT” or “NO LIFT”.



If fryer is fitted with the auto-lift option, SP-21 must be set to “YES LIFT”, otherwise, set SP-21 to “NO LIFT”.

### **Bulk Oil Supply (SP-22)**

Press  button and “SP-22 BULK OIL SUPPLY?” flashes in the left display. Press the  or  buttons to choose “YES SUPL” or “NO SUPL”.

Set to YES if the oil is pumped into the vats from an outside oil reservoir. Otherwise, set SP-22 to NO.

### **Bulk Oil Disposal (SP-23)**

Press  button and “SP-23 BULK OIL DISPOSE?” flashes in the left display. Press the  or  buttons to choose “YES DISP” or “NO DISP”.



Set to “YES DISP” if the oil is pumped from the vats to an outside oil reservoir when disarding the oil. Otherwise, set SP-23 to “NO DISP”.

### **Serial Number Log (SP-24)**

Press  button and “SP-24 S/N ✓ EDIT” flashes in the displays, along with the serial number of the unit. THIS SERIAL NUMBER SHOULD MATCH THE SERIAL NUMBER ON THE DATA PLATE, ON THE DOORS. IF NOT, IT CAN BE RECORDED.

### **Program Code Change (SP-25)**

This allows the operator to change the program code (factory set at 1, 2, 3) used to access Product Programming and Level 2 Program Mode.

Press  button and “SP-25 CHANGE MGR CODE? 1=YES” flash in the display. Press  and “ENTER NEW CODE, P=DONE, I=QUIT” show scrolls through the display. Press the product buttons for new code.

If satisfied with code, press  and “REPEAT NEW CODE, P=DONE, I=QUIT, shows in display. Press same code buttons.

## **5-1. SPECIAL PROGRAM MODE (Continued)**

### **Program Code Change (SP-25) (Continued)**

If satisfied with code, press **P** and “\*CODE CHANGED\*” shows in display.

If not satisfied with code, press **i** and “\*CANCEL” shows in display, then reverts back to “SP-25” and “CHANGE, MGR CODE? 1=YES”. Now the above steps can be repeated.

### **Usage Code Change (SP-26)**

This allows the operator to change the reset usage code (factory set at 1, 2, 3) to reset the usage amounts of each product. See Review Usage step in Information Mode.

Press **▶** button and “SP-26 CHANGE USAGE CODE? 1=YES” flashes in the display. Press **1** and “ENTER NEW CODE, P=DONE, I=QUIT show scrolls through display. Press product buttons for new code.

If satisfied with code, press **P** and “REPEAT NEW CODE, P=DONE, I=QUIT, shows in display. Press same code buttons.

If satisfied with code, press **P** “\*CODE CHANGED\*” shows in display.

If not satisfied with code, press **i** and “\*CANCEL” shows in display, then reverts back to “SP-26” and “CHANGE, USAGE CODE? 1=YES”. Now the above steps can be repeated.

### **Dispose Requires Code ? (SP-27)**

Press **▶** button and “SP-27 DISPOSE REQUIRES CODE ?” flashes in the left display. Press the **▲** or **▼** buttons to choose YES or NO. If set to YES, code 1, 2, 3 must be entered to discard the oil from the vat, using the Dispose Mode.

### **Longer Fill Time (SP-28)**



Press **▶** button and “SP-28 LONGER FILLTIME ENABLED?” flashes in the left display. Press the **▲** or **▼** buttons to choose YES or NO.

### **Let User Exit Fill (SP-29)**



Press **▶** button and “SP-29 LET USER EXIT FILL” flashes in the left display. Press the **▲** or **▼** buttons to choose YES or NO. If YES is chosen, the user can exit the Express Filter™ fill operation.

**5-1. SPECIAL PROGRAM  
MODE (Continued)**

**Skip 'SKIM' Prompt (SP-30)**













Press  button and "SP-30 SKIP 'SKIM' PROMPT?" flashes in the left display. Press the  or  buttons to choose YES or NO.

**2-Stage Wash Enabled (SP-31)**

Press  button; "SP-31 2-STAGE WASH ENABLED?" flashes in the left display. Press the  or  buttons to choose YES or NO.

**5-2. DO NOT DISTURB**

Time periods of peak operations during which the "FILTER NOW?" message will not appear, may be programmed into the fryer. There are three groupings of days - Monday thru Friday (M-F), Saturday (SAT), and Sunday (SUN). Within each day grouping, up to 4 time periods (M-F 1 thru M-F 4, SAT 1 thru SAT 4, and SUN 1 thru SUN 4) may be programmed. A time period may be anywhere from 1 to 180 minutes in length.

1. Press and hold the  button for 5 seconds until "LEVEL 2", followed by, "SP PROG" and "ENTER CODE" show in the display.
2. Press  button once more and "DO NOT DISTURB" and "ENTER CODE" flash in the left display.
3. Enter code 1, 2, 3 (first 3 product buttons).
4. "DO NOT DISTURB ENABLED?" flashes in the left display and YES or NO appears in the right display. Press the  or  buttons to choose YES or NO.
5. Press  button and "M-F 1" shows in the left display and the time flashes in the right display. Press the  or , or use product buttons, to change the time.
6. Press  button and "M-F 1" shows in the left display and "A" or "P" flashes in the right display. Use the  or  buttons to choose AM or PM.
7. Press  button and "M-F 1" shows in left display and far right character display flashes. Press product buttons to enter amount of time (up to 180 minutes) during which filtering will be inhibited, after time entered in step 5.
8. Press  button to move to the next timer period, M-F 2.
9. Repeat steps 5, 6, 7, and 8 for other desired time periods.

**5-3. CLOCK SET**

1. Press and hold the **P** button for 5 seconds until “LEVEL 2”, followed by, “SP PROG” and “ENTER CODE” show in the display.
2. Press the **P** button again and “CLK SET” and “ENTER CODE” flash in the left display.
3. Enter code 1, 2, 3 (first 3 product buttons).
4. “CS-1 ENTER DATE MM-DD-YY” flashes in the left display. Use the product buttons to set the date in the right display.
5. Press **▶** button and “CS-2 ENTER TIME” flashes in the left display and the time flashes in the right display. Press the **▲** or **▼**, or use product buttons, to change the time.
6. Press **▶** button and “CS-2 ENTER TIME” flashes in the left display and “AM” or “PM” flashes in the right display. Use the **▲** or **▼** buttons to choose AM or PM.
7. Press **▶** button and “CS-3 TIME FORMAT” flashes in the left display and “12-HR” or “24-HR” shows in the right display. Use the **▲** or **▼** buttons to choose a 12 hour time format or a 24 hour time format.
8. Press **▶** button and “CS-4 DAYLIGHT SAVING TIME” flashes in the left display. Use the **▲** or **▼** buttons to choose daylight saving time for your area: 1.OFF; 2.US (2007 & after); 3.EURO; or 4.FSA (US before 2007).

**5-4. DATA LOGGING, HEAT CONTROL, TECH, STAT, AND FILTER CONTROL MODES**

The Data Logging, Heat Control, Tech, Stat and Filter Control Modes are advanced diagnostic and program modes, mainly for Henny Penny use only. For more information on these modes, contact the Service Department at 1-800-417- 8405 or 1-937-456-8405.

## **5-5. TECH MODE**

The TECH Mode has self-diagnostic information, which can be used by certified technicians for troubleshooting purposes, such as:

- T-1** • Software
- T-2** • Fryer Type (Gas or Elec.)
- T-3** • Push Button Test
- T-4** • All On Display Test
- T-5** • Display Segment Test
- T-6** • Display Digits Test
- T-7** • Display Decimal Point Test
- T-8** • LED's Test
- T-9** • Left Temp. Probe Calibration & Offset
- T-10** • Left Level 1 Probe Calibration & Offset
- T-11** • Left Level 2 Probe Calibration & Offset
- T-12** • Right Temp. Probe Calibration & Offset
- T-13** • Right Level 1 Probe Calibration & Offset
- T-14** • Right Level 2 Probe Calibration & Offset
- T-15** • CPU Control Temp. Calibration/Offset/Highest
- T-16** • View A - D Channel
- T-17** • Digital Inputs
- T-18** • AIF Info
- T-19** • Outputs Test
- T-20** • Pumps & Valves Test
- T-21** • Recovery Test Limit
- T-22** • Drain Light Stay On?
- T-23** • Heat Err Enabled?
- T-24** • Change Tech Code?
- T-25** • Total Initialization

### **NOTICE**

Not all Tech Mode functions are discussed in this section. To ensure proper operation of fryer, please consult Henny Penny Corp. before changing any of these settings. For more information on these functions, contact the Service Department at 1-800-417- 8405, or 1-937-456-8405.

**5-5. TECH MODE (Continued)**



1. Press and hold the **P** button for 5 seconds until “LEVEL 2”, followed by, “SP PROG” and “ENTER CODE” show in the display.
2. Press the **P** button 4 times and “TECH” and “ENTER CODE” flash in the left display.
3. Enter code 1, 1, 2, 2, 1, 1, 2, 2 (first 2 product buttons).
4. “T-1 SOFTWARE” flashes in the left display and “EV-ELITE” shows in the right display. Use the ◀ and ▶ buttons to select the steps.

**NOTICE**

If a bad code is entered, a tone sounds and “BAD CODE” shows on the display. Wait a few seconds, the controls revert back to the cook mode, and repeat the above steps.

Press and hold **P** button at anytime to return to normal operation.

**T-1 - SOFTWARE**

- Press  to view HP Part No. of eeprom
- Press  to view software ID
- Press  to view software version

**T-2 - FRYER TYPE - GAS or ELEC**

**T-3 - PUSH-BUTTON TEST**

Press any of the control buttons to test operation. You should hear a beep, and the LED should light and/or a display.

**T-4 - ALL ON DISPLAY TEST**

Press any of the product buttons and all the LEDs and display segments should light.

**T-5 - SEGMENTS TEST**

Press  button to view the different segments of the display characters.

**T-6 - DIGITS TEST**

Press  button to view all segments of each digit across the displays.

**5-5. TECH MODE (Continued)**

**T-7 - DECIMAL PTS TEST**

Press  button to view all decimal points across the displays.

**T-8 - LED'S TEST**

Press  buttons to view each LED across the control panel.

**T-17 - DIGITAL INPUTS - HDE**

H = HIGH LIMIT - If "H" is present, the high limit is good. If "-" shows then the high limit is tripped out (overheated) or disconnected.

D = DRAIN SWITCH - If "D" is present, the drain handle (when applicable) is closed. If "-" shows then the drain is open or the switch is faulty.

E = ELEMENT SWITCH - If "E" is present, the element switch is good. If "-" shows in the display, the element is in the upright position, or the switch is faulty.

Press  button and an underscore ("\_") indicates the input is not presently detected. A Checkmark ("✓") indicates the signal is detecting a normal input. A blinking ("X") indicates the signal is presently detected, but is detected as a half-wave (partially failed) input.

**NOTICE**

The H, D, E signals above are wired in series. The first signal missing out of this sequence generally causes all signals to the right of it to be missing as well.



**T-18 - AIF INFO (AIF PCB communicating with control PCB?)**

An "AIF ✓" means normal communications between the AIF PCB and the control PCB. "AIF X" means a problem with the communications between the PCBs.

**T-19 - OUTPUTS**

S = SAFETY CONTACTOR - Press  to turn off and on the safety (primary) contactor



H = HEAT CONTACTOR - Press  to turn off and on the heat contactor.

( turns off and on the safety (primary) contactor for the left vat of a split vat fryer, and  turns off and on the heat contactor.)

**5-5. TECH MODE (Continued)**

**T-20 - PUMPS & VALVES**

Press ▼ button and “LIGHTS” “DLT\_” shows in displays.

Press  and left Filter Beacon® lights (split vats) and press  button and right Filter Beacon® lights (display shows “DLTo” when on)

Press ▼ button and “VALVES” “DcRc” shows in displays.

Press  to open and close the return valve.

“DcRc” means valve is closed, “DcRo” means valve is open.  
(Driven by the control board)

Press ▼ button and “DISCARDc” and “JIBFILLc” shows in the displays. (Driven by the AIF board)

Press  to open and close the RTI discard valve (display shows “DISCARD0” when open)

Press  to open and close the RTI JIB fill valve (display shows “JIBFILL0” when open)

Press ▼ button and “PUMP FP\_” and “JP\_ NP\_” shows in the displays. (Driven by the AIF board)

Press  to turn off and on the filter pump (display shows “FP\*” when on)

Press  to turn off and on the JIB pump (display shows “JP\*” when on)

Press  to turn off and on the new oil pump (if available - display shows “NP\*” when on)

**5-5. TECH MODE (Continued)**

Press ▼ button and “AIF REQ” and “RQ=Y OK=Y” shows in the displays.

“REQ=Y” means that this particular control is currently requesting control of the AIF Board outputs.

“OK=Y” means that the AIF Board has granted this control the authority to control the AIF Board outputs.

Press ▼ button and “FILR IN” and “USE BY 1(ex)” shows in the displays. These displays shows which controls are using the filtering system.

“USE = 0” = not in use

“USE = 7” = used by AIF

“USE = 1 to 5” = used by control PCB

Press ▼ button and “CPU POSN” and “1 OF 3(ex)” shows in the displays. These displays shows which controls are plugged into which port on the AIF board.

For example, the left control should be plugged into port 1, and on a 3 control fryer, shows “1 OF 3” on the display.

If the right control is unplugged, then the left control would show “1 OF 2” instead of “1 OF 3”.

Press ▼ button and “INP E\_P\_” and “JL\_Rx DF\_” shows in the displays.

AIF Board Inputs:

E = Stop button

P = Drain Pan

JL = JIB

R = RTI

DT = Discard Tank

Ex = E-Stop pressed.

Px = drain pan is missing.

Jx = JIB oil level is low.

Rx = RTI System NOT Detected

DTx = tank full

**5-5. TECH MODE (Continued)**

Press ▼ button and “OUT F\_J\_” and “N\_DI\_oJF\_” shows in the displays.

AIF Board Outputs:

Current outputs status from AIF board.

F = Filter Pump. (Fx = Filter pump is on)

J = JIB Pump. (Jx = JIB pump is on)

N = New Oil Pump. (Nx = RTI new oil pump on)  
(if present)

DI = Discard Valve. (DIo = Disc. valve open/DIc=closed)  
(if present)

JF = JIB Fill Valve. (JFo = JIB fill valve open/JFc=closed)

Press ▼ button and “REQ F\_J\_” and “N\_DI\_JF\_” shows in the displays.

AIF Board Outputs Requested by the Control Board:

Current outputs status from AIF board.

F = Filter Pump. (Fx = Filter pump is on)

J = JIB Pump. (Jx = JIB pump is on)

N = New Oil Pump. (Nx = New oil pump on)  
(if present)

DI = Discard Valve. (DIo = Disc. valve open/DIc=closed)  
(if present)

JF = JIB Fill Valve. (JFo = RTI JIB fill valve open/  
JFc=closed)

**5-6. STATS MODE**

This mode allows a technician to view advanced information on the operation of the fryer and controls.

1. Press and hold the **P** button for 5 seconds until “LEVEL 2”, followed by, “SP PROG” and “ENTER CODE” show in the display.
2. Press the **P** button 5 times and “STATS” and “ENTER CODE” flash in the left display.
3. Enter code 1, 1, 2, 2, 1, 1, 2, 2 (first 2 product buttons).
4. “ST-1 STATS LAST RESET ON...” flashes in the left display and the date shows in the right display. Use the ◀ and ▶ buttons to select the steps.

**NOTICE**

If a bad code is entered, a tone sounds and “BAD CODE” shows on the display. Wait a few seconds, the controls revert back to the cook mode, and repeat the above steps.

Press and hold **P** button at anytime to return to normal operation.

- ST-1** • Stats Last Reset Date
- ST-2** • Fryer Total Running Hours
- ST-3** • Left Vat Melt Cycle Hours
- ST-4** • Left Vat Cook Cycle Hours
- ST-5** • Left Vat Idle Hours
- ST-6** • Right Vat Melt Cycle Hours
- ST-7** • Right Vat Cook Cycle Hours
- ST-8** • Right Vat Idle Hours
- ST-9** • Power-Ups Count
- ST-10** • Error Counts
- ST-11** • Left Vat Heat On Hours
- ST-12** • Right Vat Heat On Hours
- ST-13** • Highest Left Vat Oil Temperature
- ST-14** • Highest Right Vat Oil Temperature
- ST-15** • Highest CPU Temperature

- ST-16** • System RAM Fade Count
- ST-17** • Cook RAM Fade Count
- ST-18** • Product RAM Fade Count
- ST-19** • Stat RAM Fade Count
- ST-20** • RAM Data Error Count
- ST-21** • Data Total Loss Count
- ST-22** • User Initialization Count
- ST-23** • Automatic Initialization Count
- ST-24** • Cooks Count per Product
- ST-25** • Cook Cycle Stop Counts
  - “A” = number of stops in first 30 seconds
  - “B” = 0
  - “C” = 0
  - “D” = complete cook cycles counted
- ST-26** • Reset All Stats

**SECTION 6. MAINTENANCE**

**6-1. INTRODUCTION**

This section provides checkout and replacement procedures, for various parts of the fryer. Before replacing any parts, refer to the Troubleshooting Section to aid you in finding the cause of the malfunction.

**6-2. MAINTENANCE HINTS**

1. A multimeter will help you to check the electric components.
2. When the manual refers to the circuit being closed, the multimeter should read zero unless otherwise noted.
3. When the manual refers to the circuit being open, the multimeter should read infinity.



**Do not move the fryer with hot oil in the vat or filter pan. Severe burns can result from splashing hot oil.**

**6-3. PREVENTIVE MAINTENANCE**

To ensure a long life of the fryers and their components, regular maintenance should be performed. Refer to the chart below.

<b>Frequency</b>	<b>Action</b>
Daily	Filter the oil (See Daily Filtering Instructions Section in Operator's Manual)
Daily	Change Filter Pad (See Changing Filter Pad Section in Operator's Manual)
Every filter pad change	Lubricate filter pan o-rings
Quarterly	Inspect/Change Filter Pan O-Rings (See Check/Replace Filter Drain Pan O-Ring Section)
When oil smokes, foams-upviolently, or tastes bad	Change oil
Every change of oil	Clean Vat (See Clean-Out Mode Section in Operator's Manual)

**6-4. CONTROL PANEL &  
MENU CARD  
REPLACEMENT**



Should the control panel become inoperative, or the menu card needs changed, follow these instructions:

1. Remove electrical power supplied to the vat.



**To avoid electrical shock or property damage, move the power switch to OFF and disconnect main circuit breaker, or unplug cord at wall receptacle.**

2. Remove the two screws securing the control panel.



3. Pull the top of the panel down, allowing the panel to be supported by the 2 brackets in the slots in the control shroud. (If changing control panel, continue onto step 5.)

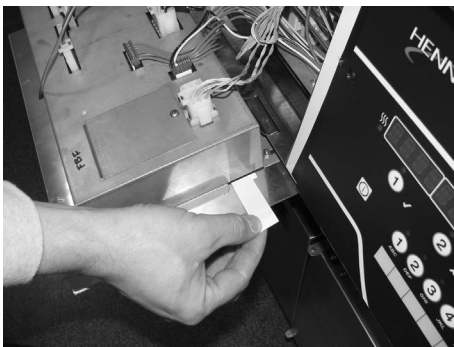

4. If changing the menu card, loosen the tape securing the menu card at the bottom, side of the control panel and pull menu card from panel. Carefully, slide changed menu card back into slot in panel and secure with tape.

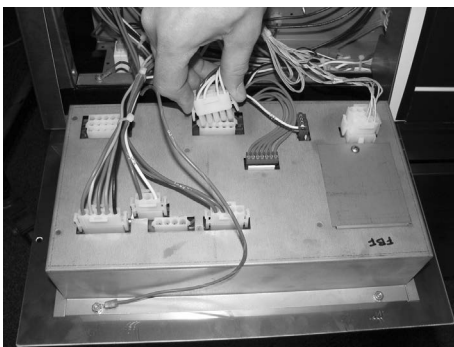

5. Unplug the connectors going to the control board.

6. Install a new control panel in reverse order.

**6-5. HIGH TEMPERATURE  
LIMIT CONTROL**



This is a safety, manual reset control, which senses the temperature of the oil. If the oil temperature exceeds 425°F (218°C), this switch opens and shuts off the heat to the vat. When the temperature of the oil drops to a safe operation limit, manually reset the control by pressing the reset button.

The reset button is located in the hinge of the element. Use a small screwdriver or Allen wrench, gently push it into the hole in the heating element hinge; if high limit does not reset, high limit must be replaced. If high limit resets, the oil starts heating.

**NOTICE**

**Checkout:**

The oil temperature must be below 380°F (193°C) to accurately perform this check.



**To avoid electrical shock or property damage, move the power switch to OFF and disconnect main circuit breaker, or unplug cord at wall receptacle.**

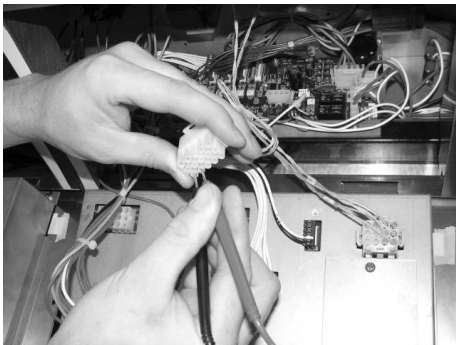

1. Remove control panel and hinge it down.
2. Referring to the decal on the rear of the control panel, locate P9 connector (left vat-split vat) or P10 connector (full or right vat).
3. Attempt to reset the high limit and then pull the connector from the board and check for continuity between the 2 appropriate pins. If the circuit is open then continue replacement procedure. (If the circuit is closed, the high limit is not defective.

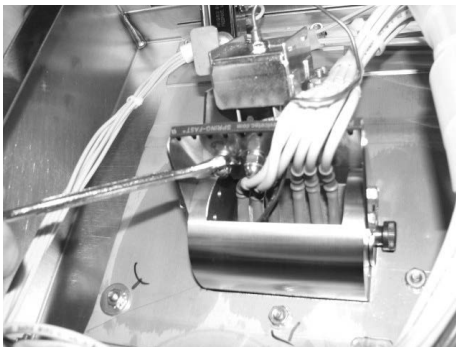

**Replacement**

If the tube is broken or cracked, the control opens, shutting off electrical power. The control cannot be reset.

1. Using a Phillip's-head screwdriver, or screw gun, remove the rear panel (9 screws).
2. Using 3/8" wrench or socket, remove the 2 acorn nuts securing bracket to unit.
3. Using a Phillip's-head screwdriver, remove the 2 screws securing the high limit to the bracket.



**6-5. HIGH TEMPERATURE  
LIMIT CONTROL  
(Continued)**



**Replacement (continued)**

4. Use the lift tool and lift the hinged element from the vat.

**CAUTION**

*Avoid putting the lift tool in the center of the elements, at the same area as the high limit bulb, or damage to the high limit could result.*

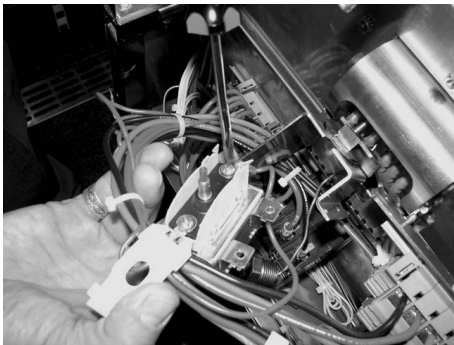

5. Pull the high limit from the bracket, pull back the cardboard protector, and remove the two electrical wires from the high limit control.



6. Pull-out on the drain valve knob and drain the oil from the vat.



7. While holding the top-side capillary bracket, use a Phillip's-head screwdriver and remove the screws securing the capillary bulb to the lower element bracket. Remove both front and rear capillary brackets.

**6-5. HIGH TEMPERATURE  
LIMIT CONTROL  
(Continued)**

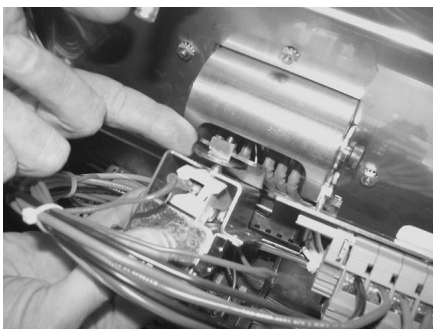

**Replacement (continued)**

8. Using a Phillip's-head screwdriver, remove the screws securing the capillary bulb to the upper element brackets.
9. Remove high limit bulb from element and carefully straighten the capillary tube and pull the high limit control from the rear of the unit.

*It's important not to damage the capillary bulb when removing or installing the high limit from the unit. Undamaged high limits returned for warranty can be evaluated for cause of failure.*

*Capillary bulbs or tubes damaged during installation causes high limit to fail prematurely. See damaged capillary bulb below.*

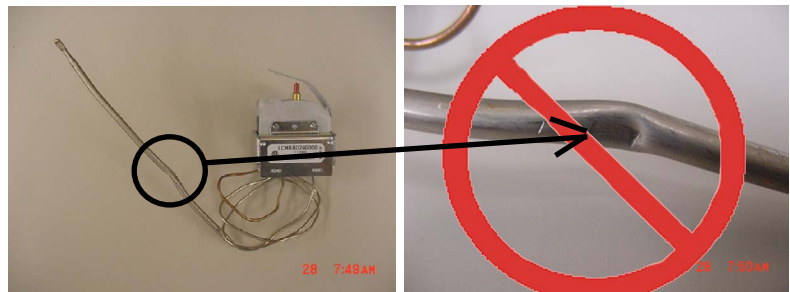

10. Insert new high limit capillary through hole in rear of fryer and slide high limit into bracket and then secure with the 2 screws.
11. Slide bracket and high limit assembly into place, making sure a 1/8" (2-3mm) gap remains between the red high limit button and the reset place, and then secure with the 2 acorn nuts removed in step 3.
12. Carefully slide capillary bulb up through the element, from the rear of the elements.

**6-5. HIGH TEMPERATURE  
LIMIT CONTROL  
(Continued)**

**Replacement (continued)**

- Using the capillary brackets removed in step 3 (see below), attach the capillary to the lower brackets, aligning the capillary so it does NOT touch the element. (See side-view drawing for proper installation)



**Left-Front/Right-Rear**

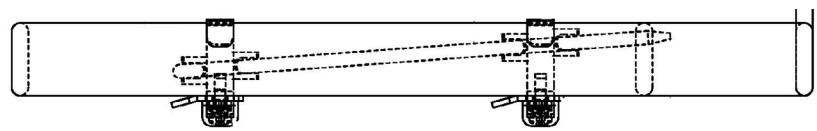

**Element Side View**



- Secure the capillary to the upper brackets.
- Replace rear cover and reconnect power to vat.
- Lower element back into vat and close drain. Fill vat by pressing and holding **F** button until \*FILTER\*\*MENU\* shows in the display. Then once "1.EXPRESS FILTER" shows in the display, press **▶** 4 times until "5.FILL FROM PAN" shows in the display. Press **√** button and "PUMP" "EXIT" shows in the display. Press **√** button again, and oil fills vat. Once vat is full, press **X** twice to return to normal operation.

## 6-6. BREAKERS

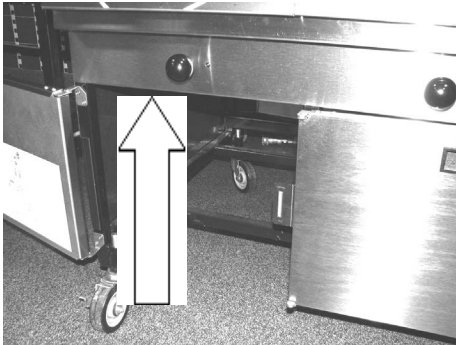

There are 4 breaker on the electric fryers. To reset the breaker, open the left door and and locate breakers behind drain knob plate. Push on the plunger on the breaker to reset.



To avoid electrical shock or property damage, move the power switch to OFF and disconnect main circuit breaker, or unplug cord at wall receptacle.

### Checking Procedure for Breaker

Remove the left control panel and pull the wires from the breaker. Using a multimeter or continuity light, check across the terminals. The circuit should be closed. If not, replace the breaker (HP# [EF02-125](#)).

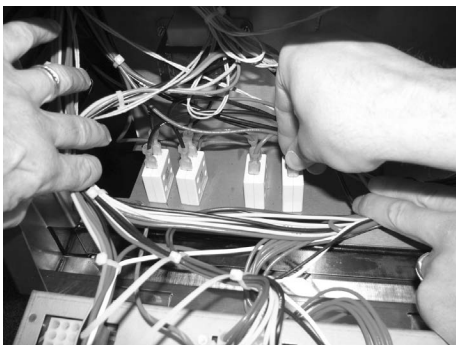

To replace breaker, remove left control panel and pull wires from breaker.

Use a 9/16" wrench and loosen the nut securing the breaker from underneath and then pull the breaker from the control panel area.

**6-7. MAIN POWER SWITCH**

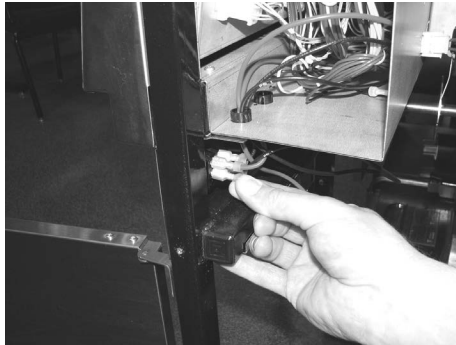

This is a covered rocker switch, which in the ON position, sends power to all the controls and filter motor.



**To avoid electrical shock or property damage, move the power switch to OFF and disconnect main circuit breaker, or unplug cord at wall receptacle.**

1. Remove right side panel.
2. Label and remove wires from the switch.
3. From the inside of the control area, squeeze in on the tabs on the back of the switch and push the switch out the front of the control area.

**Checkout**

4. Check across the two sets of terminals of the switch for continuity. With the switch in the ON position, the circuit should be closed. With the switch in the OFF position, the circuit should be open.

If the switch is found to be defective, replace it by connecting the wires to it (as labeled) and push new switch into place.

**6-8. TEMPERATURE PROBE REPLACEMENT**

Temp. F	Temp. C	Resistance Ohms	Temp. F	Temp. C	Resistance Ohms
50	10.00	1039.02	250	121.11	1464.79
60	15.56	1060.65	260	126.67	1485.71
70	21.11	1082.24	270	132.22	1506.58
80	26.67	1103.80	280	137.78	1527.43
90	32.22	1125.32	290	143.33	1548.23
100	37.78	1146.81	300	148.89	1569.00
110	43.33	1168.26	310	154.44	1589.73
120	48.89	1189.67	320	160.00	1610.43
130	54.44	1211.05	325	162.78	1620.77
140	60.00	1232.39	330	165.56	1631.09
150	65.56	1253.70	340	171.11	1651.72
160	71.11	1274.97	350	176.67	1672.31
170	76.67	1296.20	360	182.22	1692.86
180	82.22	1317.40	365	185.00	1703.13
185	85.00	1327.99	370	187.78	1713.38
190	87.78	1338.57	380	193.33	1733.87
200	93.33	1359.69	390	198.89	1754.31
210	98.89	1380.79	400	204.44	1774.72
212	100.00	1385.00	410	210.00	1795.10
220	104.44	1401.84	420	215.56	1815.44
230	110.00	1422.86	430	221.11	1835.74
240	115.56	1443.85	440	226.67	1856.01

The temperature probe relays the actual shortening temperature to the control. If it becomes disabled, “E-6” shows in the display. Also, if the temperature is out of calibration more than 10°F, or 10°C, the temperature probe should be replaced. (See Section 5-4. TECH MODE for probe calibration steps.)

An Ohm check can be performed also. See chart at left and Checkout instructions on next page.

**6-8. TEMPERATURE PROBE  
REPLACEMENT  
(Continued)**

Checkout:



To avoid electrical shock or property damage, move the power switch to OFF and disconnect main circuit breaker, or unplug cord at wall receptacle.

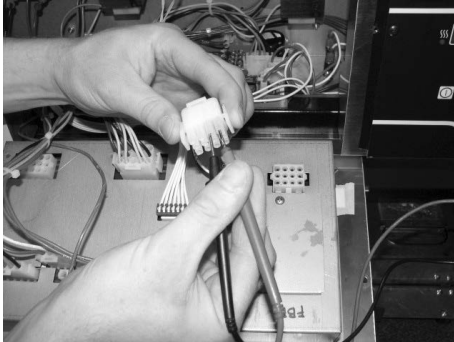

1. Remove control panel and hinge it down.
2. Referring to the decal on the rear of the control panel, locate the 12-pin probe connector in the upper, right-hand corner. (An ohm chart is also shown on the decal.)
3. Pull the connector from the panel and using a multimeter, take an ohm reading on the appropriate Oil Temp pins. If ohm reading is significantly different than the chart, continue with replacement instructions.



**Replacement:**



1. Pull-out on the drain valve knob and drain the oil from the vat.



2. Remove the rear panel (9 screws).
3. Using a 1/2" wrench, remove the nut on the compression fitting, and remove the temperature probe from the vat.
4. Follow the probe wires and disconnect the 2 probe connectors. (These may be found behind the control panel or behind the side panels, depending upon which vat is being serviced.)

**6-8. TEMPERATURE PROBE  
REPLACEMENT  
(Continued)**

5. Follow probe installation instructions below:

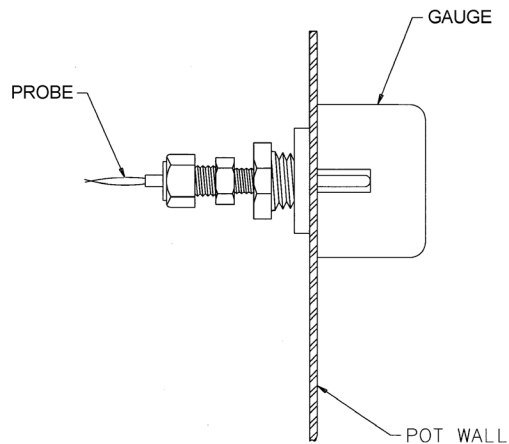

- NOTE:  
1.) LOCATE TEMPERATURE PROBE THRU POT WALL.  
2.) PLACE GAUGE AGAINST POT WALL AS SHOWN.  
3.) PUSH TEMPERATURE PROBE THRU UNTIL IT MAKES CONTACT WITH GAUGE.  
4.) TIGHTEN TEMPERATURE PROBE IN PLACE.

**CAUTION**

*Excess force will damage temperature probe. Hand-tighten nut and then 1/2 turn with a wrench.*

6. Connect new temperature probe to the 2 fryer connections.
7. Replace rear cover and reconnect power to vat.
8. Lower element back into vat and close drain. Fill vat by pressing and holding **F** button until \*FILTER\* \*MENU\* shows in the display. Then once "1.EXPRESS FILTER" shows in the display, press **▶** 4 times until "5.FILL FROM PAN" shows in the display. Press **√** button and "PUMP" "EXIT" shows in the display. Press **√** button again, and oil fills vat. Once vat is full, press **X** twice to return to normal operation.

**6-9. OIL CHANNEL  
CLEAN-OUT**



Should the drain channel, under the vats, become clogged, access to a clean-out plug is available by removing the right or left side panels.

## **6-10. ELEMENT SAFETY SWITCH**

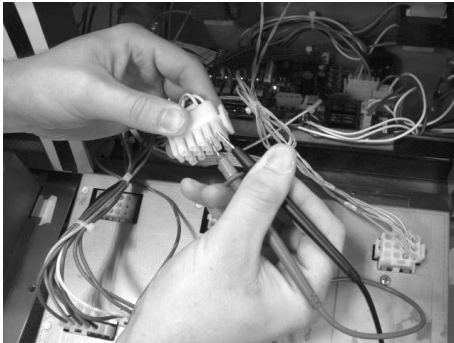

This switch cuts power to the element when the element is raised.

If a constant “E-31” “HEATING ELEMENTS ARE UP”, is shown on the display, when the elements are lowered into the vat, check the element safety switch.



**To avoid electrical shock or property damage, move the power switch to OFF and disconnect main circuit breaker, or unplug cord at wall receptacle.**

### **Checkout:**

1. Remove control panel and hinge it down.
2. Referring to the decal on the rear of the control panel, locate P9 connector (left vat-split vat) or P10 connector (full or right vat).
3. Pull the connector from the panel and using a multimeter, check for continuity between the 2 appropriate pins (labeled HEAT SWITCH). With the plunger on the safety switch pushed in (element lowered), the circuit should be closed. With the element raised, the circuit is should be open. If the switch proves to be faulty, continue with replacement instructions.



### **Replacement:**

1. Remove the rear panel (9 screws).
2. Pull the wires from the switch.
3. Use Phillip's-head screwdriver and remove the 2 screws securing the switch.
4. Reassemble with new switch, making sure the plate pushes-in the switch plunger, activating the switch, and then reconnect power to the fryer.



**6-11. CONTACTORS**

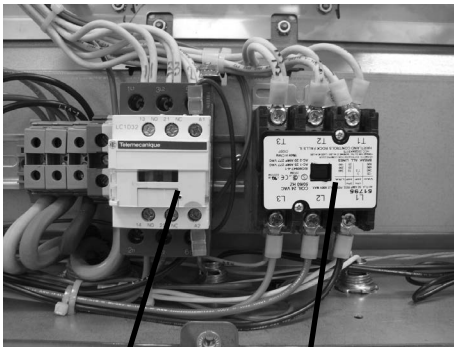

Heat

Safety

The Evolution Elite® fryer requires two switching, 24V contactors per vat: a primary and a heat contactor. The primary contactor energizes (contacts close) any time the main power switch is in the ON position, and the temperature of the shortening is below 420° F ( 215° C). The high limit cuts power at the primary contactor if the temperature of the shortening is above 420° F ( 215° C). The primary contactor supplies power to one side of the heat contactor.

The heat contactor is controlled by the computer controller. When the  button is pressed and the controller calls for heat, the heat contactor applies power to one side of the heating elements. When the heat contactor and primary contactor are energized (contacts closed) the electric heating elements heat the shortening.

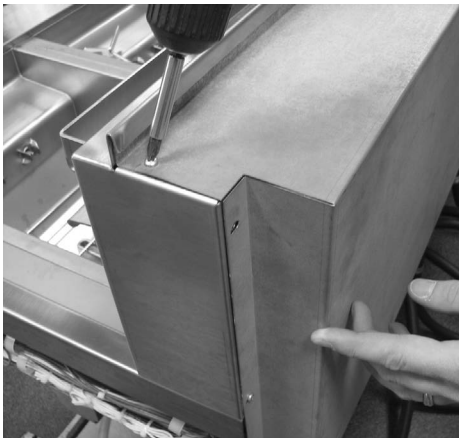

**Checkout**

1. Remove electrical power supplied to the fryer.



**To avoid electrical shock or property damage, move the power switch to OFF and disconnect main circuit breaker, or unplug cord at wall receptacle.**

2. Remove the top, rear panel.

3. Label and remove wires from contactors and perform a check on both contactors as follows:

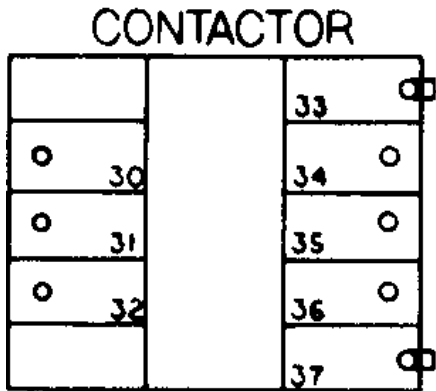

<u>Test Points</u>	<u>Results</u>
From 30 to 34	open circuit
From 31 to 35	open circuit
From 32 to 36	open circuit
From 33 to 37 (coil)	ohm reading 5 to 6



**To avoid electrical shock, make connections before applying power, take reading, and remove power before removing meter leads. The following checks are performed with the wall circuit breaker closed and the main power switch in the ON position.**

## **6-11. CONTACTORS** **(Continued)**



4. With power reappplied and in a heat-up mode, check the power going to both contactor coils. Power should be going to both contactors.

If no voltage is found going into the primary contactor coil, check wiring, high limit, and element switch.

If no voltage at heat contactor coil check wiring and connections at PC board.

### **Replacement**

If either contactor proves defective, replace as follows:



**To avoid electrical shock or property damage, move the power switch to OFF and disconnect main circuit breaker, or unplug cord at wall receptacle.**

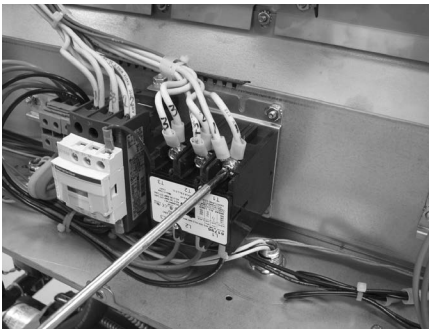

1. Label and remove only those wires directly connected to the contactor being replaced.
2. Using a 3/8" wrench or socket, remove the 2 mounting nuts on the base plate of the contactor being replaced and remove contactor.
3. When replacing the heat contactor, slide it from the mounting rail.
4. Install new contactor in reverse order.
5. Replace rear panel and reconnect power to the fryer and test for proper operation.

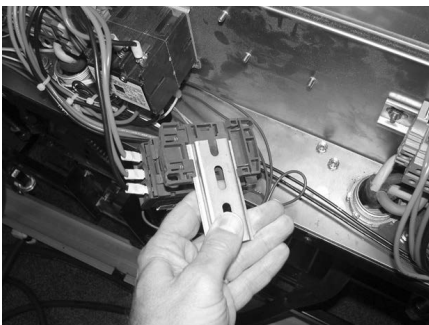
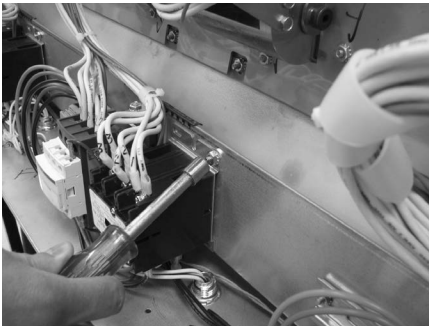

## **6-12. SOLENOID VALVES**

Each vat has a solenoid plumbed-into the oil return lines. They are normally closed, but open when power is supplied, such as, the controls are filling the vats.



**To avoid electrical shock or property damage, move the power switch to OFF and disconnect main circuit breaker, or unplug cord at wall receptacle.**

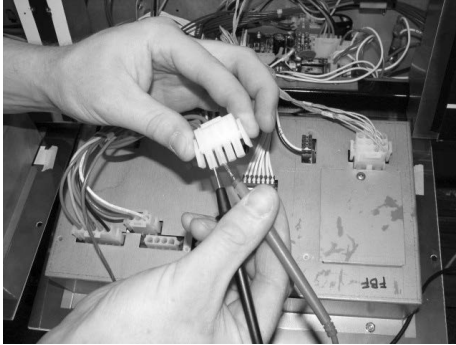

1. Remove control panel and hinge it down.
2. Referring to the decal on the rear of the control panel, locate P3 connector (left vat-split vat) or P4 connector (full or right vat).
3. Pull the connector from the panel and using a multimeter, take an ohm reading on the appropriate pins. If ohm reading is significantly different than the chart below, continue with replacement instructions.

120Volts-60Hertz	50 Ohms
220-240Volts-50Hertz	230 Ohms

### **Replacement**

1. Remove the rear panel (9 screws).
2. Remove the plastic retaining clip on top of the coil housing.
3. Push-down and then lift-up on name-plate and remove the name-plate, cover and coil housing from solenoid stem.
4. Using a 1" wrench, loosen the fitting on the right side of the solenoid.

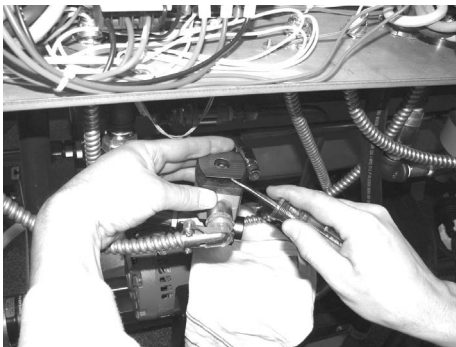
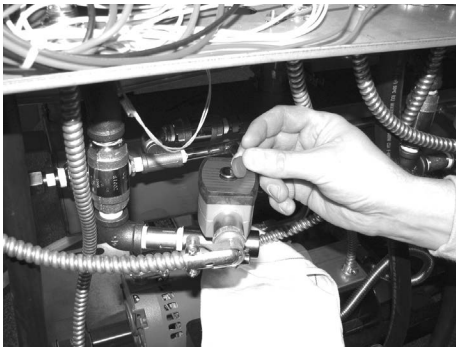

**6-12. SOLENOID VALVES**  
**(Continued)**

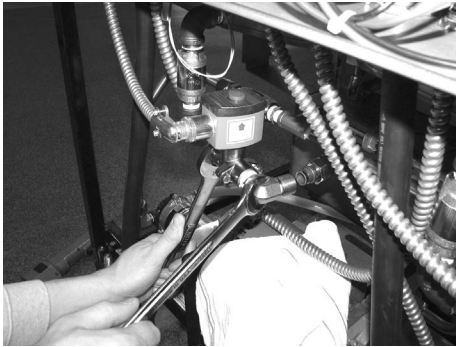

5. Pull the elbow away from the 1" nut, and using a 1-1/16" wrench or adjustable wrench, hold the solenoid in place while using another wrench to remove the elbow from the solenoid. Attach elbow to new solenoid, using pipe sealant on the threads.



6. Pull the coil housing from the solenoid stem. Hold the pipe nipple in place with a pipe wrench and using a 1-1/16" wrench or adjustable wrench, remove the solenoid from the nipple.



7. Remove the conduit from the fryer and pull the coil assembly from the fryer.

8. Disconnect conduit at coil.

9. Thread the wires of the new solenoid through the conduit and reattach the conduit to the fryer.



10. Wire nut the solenoid wires onto the fryer wires, and then, attach the solenoid assembly onto the fittings of the fryer.

11. Replace rear cover and reconnect power to the fryer.

### **6-13. FILTER PUMP & MOTOR**



The 2 most common causes for a fryer not to pump oil are that the pump is clogged, or the thermal overload switch has been tripped on the motor. The pump and motor is located on the rear of the fryer.

To remove debris from pump:

1. Loosen the four Allen head screws on the end of pump and remove the cover. (Removing the bottom rear panel may help in accessing the set screws.)
2. The inside is now exposed leaving a rotor and five teflon rollers. Clean the rotor and rollers.
3. To reassemble, place rotor on drive shaft, and place roller into rotor.

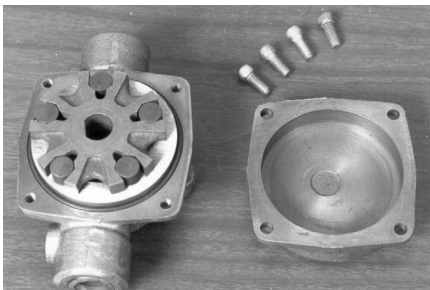

### **NOTICE**

A small amount of grease might be needed to hold the bottom roller into place until cover plate is put on. Make sure O-ring is in proper position on plate.

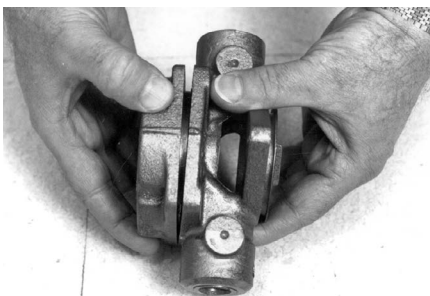

### **CAUTION**

*There is an indicator on the side of the two halves of the pump, this mark must be together*



To reset the thermal overload switch:

1. Locate the pump and motor in the rear of the fryer and if the motor is hot, allow it to cool for about 5 minutes.
2. Since it takes some effort to reset the switch, use a tool, such as a Phillip's-head screwdriver, to press against the reset button until a "click" is heard.

**6-13. FILTER PUMP & MOTOR**  
**(Continued)**



To avoid electrical shock or property damage, move the power switch to OFF and disconnect main circuit breaker, or unplug cord at wall receptacle.

**Motor Removal:**

1. Remove JIB from fryer.



2. Remove the rear panel and the right side panel.

3. Using a 7/8" wrench, loosen the front, flexible line fitting, on the pump.



4. Using a 1" wrench, loosen the rear pump fitting.

5. Using Phillip's-head screwdriver, remove the rear cover from motor, exposing the wires.

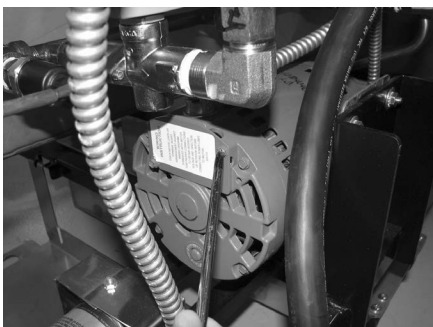

6. Loosen the conduit clamp and pull the wires through the conduit clamp.

**6-13. FILTER PUMP & MOTOR**  
**(Continued)**

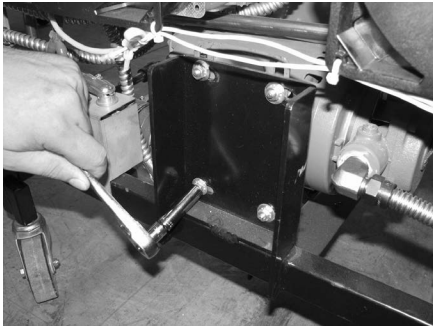

7. Using a 7/16 in. wrench, remove the 4 bolts securing the motor to the motor bracket and pull the pump and motor assembly from fryer.
8. Pull pump and motor out, from front of fryer, across the JIB shelf.

**To replace pump on motor:**

1. Using a 1/2 in. wrench, remove the 2 bolts securing the pump to the motor and pull the pump from the motor.
2. Install a new seal kit (part no. [17476](#)) onto shaft of motor.
3. Align the shaft of the motor with the rotor on the inside of the pump and push pump onto shaft of motor.
4. Secure the pump onto the motor with the 2 bolts.

**6-14. JIB PUMP**

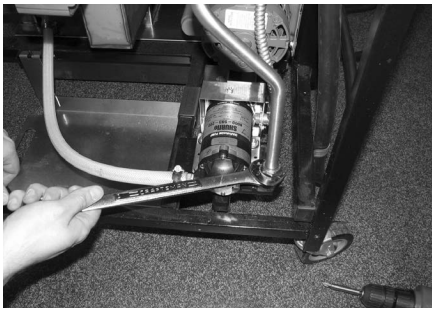

**6-15. EXPRESS FILTER PC BOARD**

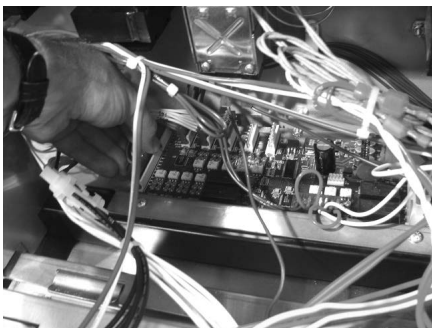

This pump keeps the vats filled and is used in the Oil Guardian™ process.

**Replacement**



**To avoid electrical shock or property damage, move the power switch to OFF and disconnect main circuit breaker, or unplug cord at wall receptacle.**

1. Remove the right side panel.
2. Using a 1” wrench, loosen fitting on right side of pump.
3. Remove the hose from the pump.
4. Remove the 4 bolts securing the bottom of pump.
5. Disconnect the wires in the rear of the pump and pull assembly from fryer.
6. Pull fittings from faulty pump and attach the fittings to the new pump, in the same orientation.
7. Install new pump assembly in fryer, in reverse order and then reconnect power to fryer.

This electronic board controls the Automatic Intermittant Filtering process.

**Replacement**



**To avoid electrical shock or property damage, move the power switch to OFF and disconnect main circuit breaker, or unplug cord at wall receptacle.**

1. Hinge-down the center control panel (right panel on 2 vat units).
2. Pull connectors from PC board, located behind control panel.
3. Using a 5/16” socket, remove the 6 nuts securing the board and remove it from the fryer.
4. Install in reverse order. The control connectors are colored-coded; Left-Red; Middle-White; Right-Blue.

**6-16. TRANSFORMERS**

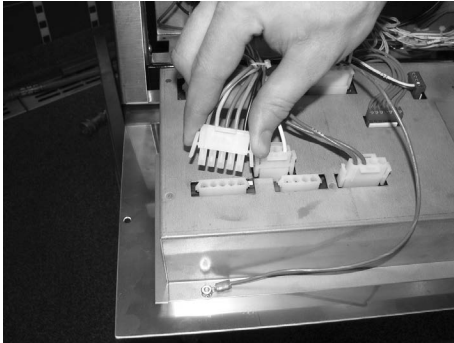

**Control Transformer Connector**

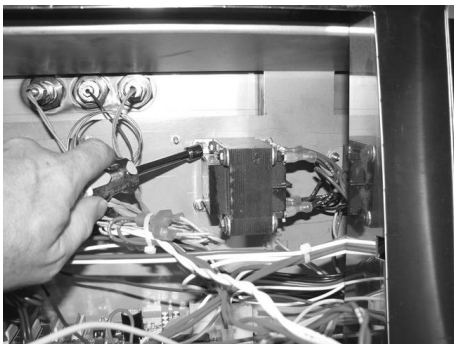
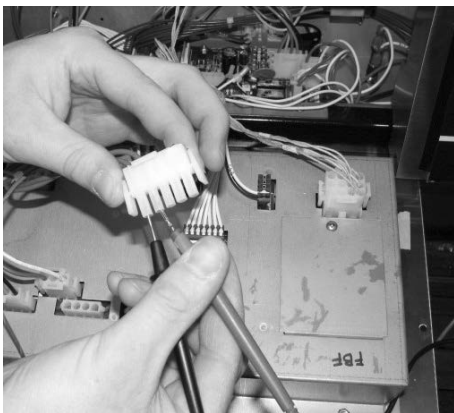

**Express Filter Transformer**

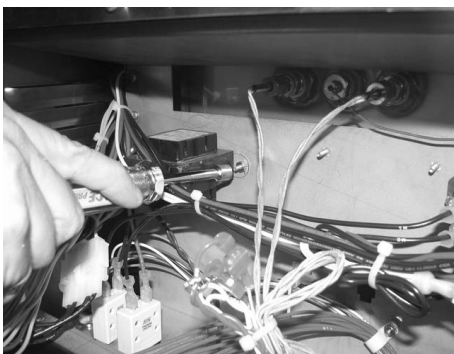

**Control Transformer**

Both the Express Filter transformer and the control transformer are the same part number. These components drop the line voltage to low voltage components such as, control board, Express Filter board and contactors.

**Checkout:**



**To avoid electrical shock or property damage, move the power switch to OFF and disconnect main circuit breaker, or unplug cord at wall receptacle.**

1. Hinge-down the control panel to access the desired transformer.
2. Pull the appropriate white connector, either from the Express Filter PC board or from the control PC board.



**To avoid electrical shock, use care when checking the transformer. The following checks are performed with the wall circuit breaker closed and the main power switch in the ON position.**

3. With the power on, take a voltage reading on the appropriate pins, using the chart and drawing below. If transformer proves faulty, continue with replacement instructions.

Pin 1-2 = 24 VAC  
Pin 4-5 = 240 VAC  
Pin 3-5 = 208 VAC

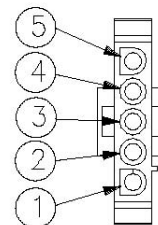

**Replacement**

1. Disconnect power and using a 5/16" socket, remove the nuts securing the transformer and pull the transformer from unit.
2. Replace transformer in reverse order.

### **6-17. FILTER MOTOR RELAY**

This component is located behind the left control panel and regulates voltage to the filter motor.

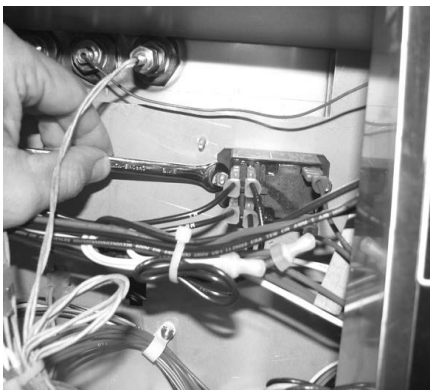
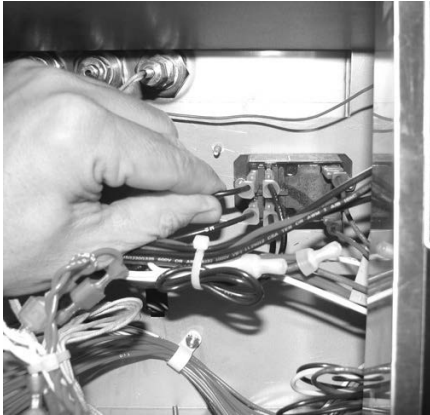

#### **Replacement:**



**To avoid electrical shock or property damage, move the power switch to OFF and disconnect main circuit breaker, or unplug cord at wall receptacle.**

1. Hinge-down the left control panel.
2. Label and remove wires from relay.
3. Using a 5/16" wrench, remove the nuts securing the relay and remove relay from fryer.
4. Install new relay in reverse order.

**6-18. DRAIN PAN SWITCH**

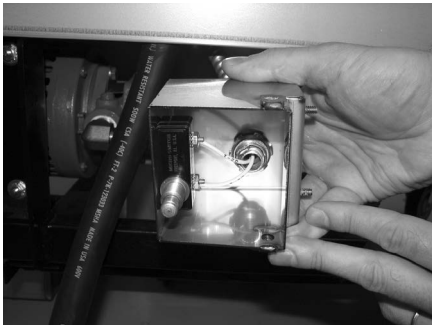
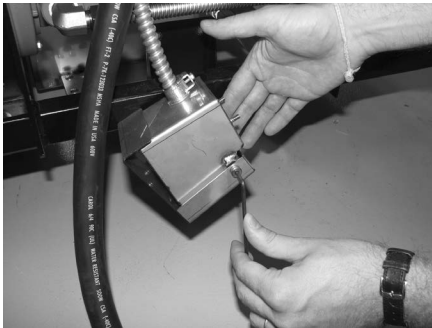
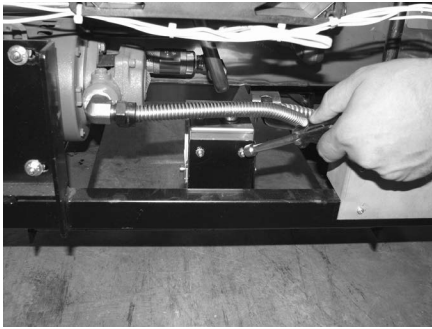

This switch closes when the drain pan is pushed properly in place under the fryer. If the drain pan is not properly in place, or the drain switch is faulty, display prompts such as, “CHECK PAN”; “FILTER PAN MISSING”; “CHANGE FILTER PAD” shows in the display.



**To avoid electrical shock or property damage, move the power switch to OFF and disconnect main circuit breaker, or unplug cord at wall receptacle.**

1. Remove control panel and hinge it down.
2. Locate the 8-pin connector on the Express Filter PC board and pull the connector from the board.
3. Check for normally open circuit between the pins with wires labeled D1 & D2. If the circuit shows closed, continue with the replacement instructions below.

**Replacement:**

1. Drain pan switch is located on the rear of the fryer. Using a 3/8” socket or nut driver, remove the nuts securing the drain switch bracket to the fryer.
2. Using a 1/8” Allen wrench, remove the shoulder bolt securing the cover and remove cover.
3. Using a Phillips-Head screwdriver, remove the screws securing the switch to the bracket and remove switch from bracket.
4. Label and remove wires from switch
5. Replace faulty switch, placing wires on new switch on the normally open and common terminals.

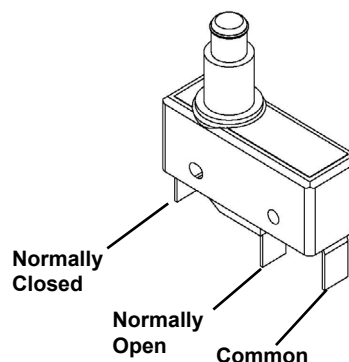

**6-19. FILTER BEACON®**

**Replacement**



**To avoid electrical shock or property damage, move the power switch to OFF and disconnect main circuit breaker, or unplug cord at wall receptacle.**

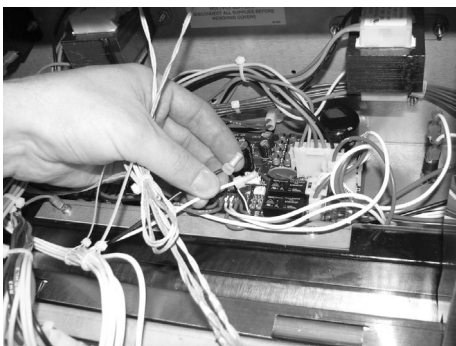
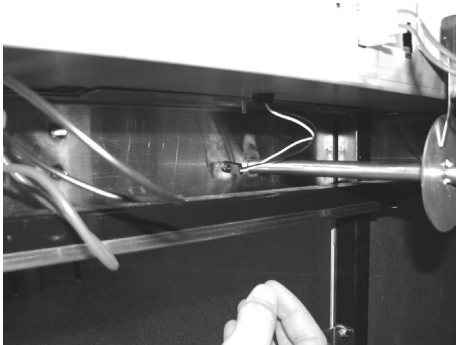

1. Remove right or left side panel for end vats, or hinge-down the control panel for center vats.

2. Pull apart the light by pulling on the rear of the light and removing the front part of the light from the front of the fryer.

3. Locate and cut the light wires and pull the light from unit.

4. Connect new light wires, using wirenuts and install light in reverse order.

5. Restore power to the unit.

**6-20. OIL LEVEL PROBES**



Oil level probes

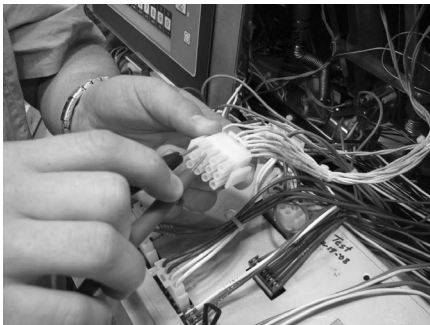

The oil level probes (left & right-see photo at left) monitor the oil level by temperature differences. If they becomes disabled, the display shows: “E-18A”= left probe; “E18-B”= right probe; “E18C”= both.

Also, if any of the probes are out of calibration more than 10°F, or 10°C, the temperature probe should be replaced. (See Section 5-4. TECH MODE for probe calibration steps.) An Ohm check can be performed also. See chart below.

Checkout:



To avoid electrical shock or property damage, move the power switch to OFF and disconnect main circuit breaker, or unplug cord at wall receptacle.

1. Remove control panel and hinge it down.
2. Referring to the decal on the rear of the control panel, locate the 12-pin probe connector in the upper, right-hand corner. (An ohm chart is also shown on the decal.)
3. Pull the connector from the panel and using a multimeter, take an ohm reading on the appropriate Level Probe pins. If ohm reading is significantly different than the chart, continue with replacement instructions on next page.

Temp. F	Temp. C	Resistance Ohms	Temp. F	Temp. C	Resistance Ohms
50	10.00	1039.02	250	121.11	1464.79
60	15.56	1060.65	260	126.67	1485.71
70	21.11	1082.24	270	132.22	1506.58
80	26.67	1103.80	280	137.78	1527.43
90	32.22	1125.32	290	143.33	1548.23
100	37.78	1146.81	300	148.89	1569.00
110	43.33	1168.26	310	154.44	1589.73
120	48.89	1189.67	320	160.00	1610.43
130	54.44	1211.05	325	162.78	1620.77
140	60.00	1232.39	330	165.56	1631.09
150	65.56	1253.70	340	171.11	1651.72
160	71.11	1274.97	350	176.67	1672.31
170	76.67	1296.20	360	182.22	1692.86
180	82.22	1317.40	365	185.00	1703.13
185	85.00	1327.99	370	187.78	1713.38
190	87.78	1338.57	380	193.33	1733.87
200	93.33	1359.69	390	198.89	1754.31
210	98.89	1380.79	400	204.44	1774.72
212	100.00	1385.00	410	210.00	1795.10
220	104.44	1401.84	420	215.56	1815.44
230	110.00	1422.86	430	221.11	1835.74
240	115.56	1443.85	440	226.67	1856.01

**6-20. OIL LEVEL PROBES**  
**(Continued)**

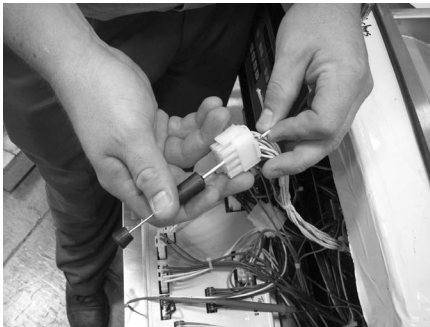

**Replacement:**

1. Pull-out on the drain knob and drain oil from vat.
2. Using a 1/2" wrench, remove the nut on the compression fitting, and remove the temperature probe from the vat.
3. Using a terminal extractor, remove the probe terminals from the connector and pull remove probe from unit.
4. Place the nut and new ferrule on the new temperature probe and insert the temperature probe into the compression fitting.

Follow probe installation instructions below:

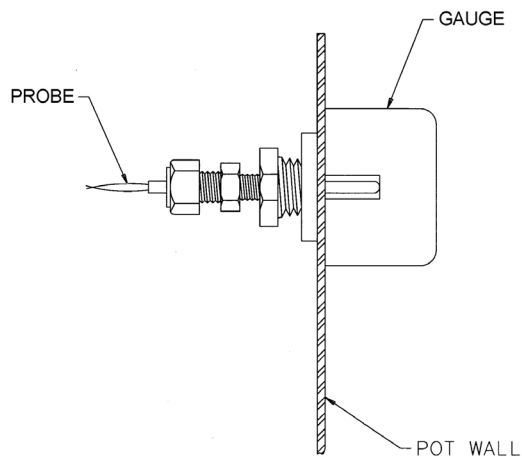

- NOTE:
- 1.) LOCATE TEMPERATURE PROBE THRU POT WALL.
  - 2.) PLACE GAUGE AGAINST POT WALL AS SHOWN.
  - 3.) PUSH TEMPERATURE PROBE THRU UNTIL IT MAKES CONTACT WITH GAUGE.
  - 4.) TIGHTEN TEMPERATURE PROBE IN PLACE.

**CAUTION**

*Excess force will damage temperature probe. Hand-tighten nut and then 1/2 turn with a wrench.*

**6-20. OIL LEVEL PROBES**  
**(Continued)**

5. Connect new temperature probe to the connector and fasten connector onto control panel.
6. Replace control panel and reconnect power to vat.
7. Fill vat by pressing and holding **F** button until \*FILTER\* \*MENU\* shows in the display. Then once "1.EXPRESS FILTER" shows in the display, press **▶** 4 times until "5.FILL FROM PAN" shows in the display. Press **√** button and "PUMP" "EXIT" shows in the display. Press **√** button again, and oil fills vat. Once vat is full, press **X** twice to return to normal operation.

This component prevents the elements from heating while the drain is open by disrupting the power to the heat contactor.

**6-21. DRAIN ROD**  
**MICROSWITCH**

Checkout:



**To avoid electrical shock or property damage, move the power switch to OFF and disconnect main circuit breaker, or unplug cord at wall receptacle.**

1. Remove control panel and hinge it down.
2. Referring to the decal on the rear of the control panel, locate P9 connector (left vat-split vat) or P10 connector (full or right vat).
3. Check for normally open circuit between the 2 appropriate pins. If the circuit shows closed, continue with the replacement instructions below.

**Replacement:**

1. Remove right or left side panel, depending upon what side the faulty switch is on.
2. Pull connector from behind control panel area.
3. Using Phillip's-head screwdriver and a 5/16" socket, remove the nut and screw securing the switch and remove switch from unit.
4. Remove wires from switch and place on new switch, placing them on the normally open and common terminals.
5. Install new switch in reverse order.

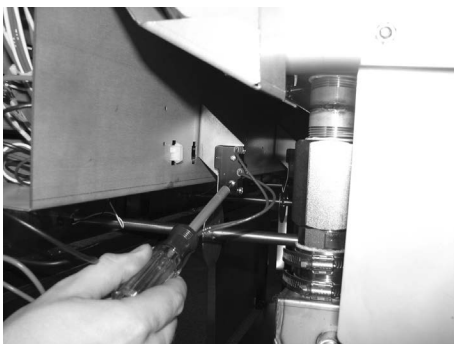
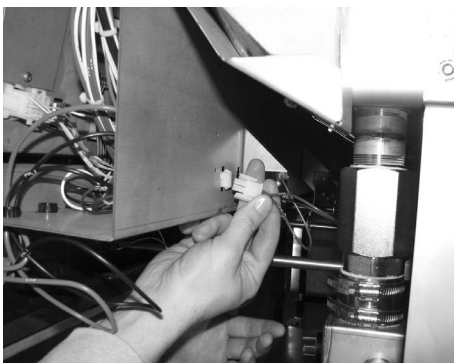

**6-22. TIME-DELAY-RELAYS**  
**(EEE-153 & EEE154)**

This relay is located behind the left control panel and transfers electrical power to the control to the right, if power is lost in the left vat.

**Replacement**



**To avoid electrical shock or property damage, move the power switch to OFF and disconnect main circuit breaker, or unplug cord at wall receptacle.**

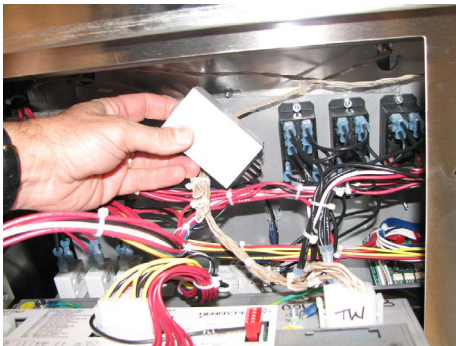

1. Hinge-down the left control panel.
2. Pull straight up on the delay timer to disengage it from the base.
3. Replace in reverse order

The legend below helps in identifying the components of the wiring diagrams on the following wiring diagrams.

LEGEND	
ABBREV	DEFINITION
CB	CIRCUIT BREAKER
CP	CONTROL POWER
D	DRAIN
DISV	OIL DISPOSAL VALVE
DS	DRAIN SWITCH
FL	FILTER LIGHT
G	GROUND
J	JUMPER
JM	JIB MOTOR
JMF	JIB MOTOR FUSE
JP	JUMPER POWER
L1	LINE 1
L2	LINE 2

LEGEND	
ABBREV	DEFINITION
L3	LINE 3
LDS	LEFT DRAIN SWITCH
LH	LEFT HEAT
LHL	LEFT HIGH LIMIT
LRV	LEFT RETURN VALVE
LS	LEFT SAFETY
LTS	LEFT TILT SWITCH
M	MOTOR
PB	PROBE
PS	POWER SWITCH
R	RELAY
RDS	RIGHT DRAIN SWITCH
RH	RIGHT HEAT

LEGEND	
ABBREV	DEFINITION
RHL	RIGHT HIGH LIMIT
N	NEUTRAL
RRV	RIGHT RETURN VALVE
RS	RIGHT SAFETY
RTS	RIGHT TILT SWITCH
TR	TRANSFORMER
-	EXT. OF THE SAME SIGNAL
LAL	LEFT AUTOLIFT
RAL	RIGHT AUTOLIFT

# 208/240 VOLT WIRING DIAGRAMS

# Wendy's

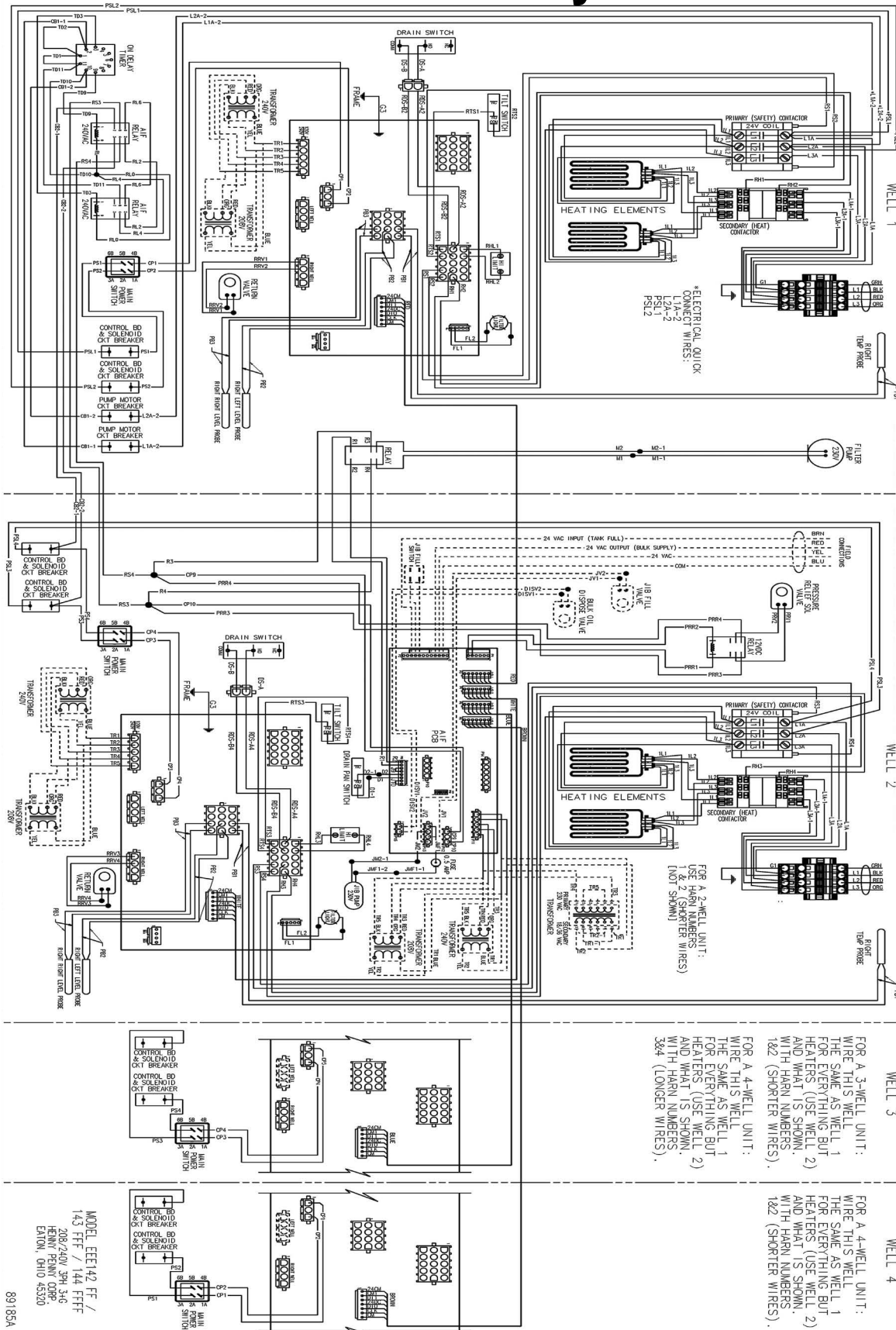

MODEL EEE147 FF /  
143 FFF / 144 FFFF  
H200 / 200V 3PH 3LG  
H200 / 200V 3PH 3LG  
EATON, OHIO 45320

89185A



## **SECTION 7. PARTS INFORMATION**

### **7-1. INTRODUCTION**

This section lists the replaceable parts of the Henny Penny Evolution Elite® fryer.

### **7-2. GENUINE PARTS**

Use only genuine Henny Penny parts in your fryer. Using a part of lesser quality or substitute design may result in damage to the unit or personal injury.

### **7-3. WHEN ORDERING PARTS**

Once the parts that you want to order have been found in the parts list, write down the following information:

Item Number	<u>2</u>	Example:
Part Number	<u>60241</u>	
Description	<u>High Limit</u>	

From the data plate, list the following information:

Product Number	<u>01100</u>	Example:
Serial Number	<u>0001</u>	
Voltage	<u>208</u>	

### **7-4. PRICES**

Your distributor has a price parts list and will be glad to inform you of the cost of your parts order.

### **7-5. DELIVERY**

Commonly replaced items are stocked by your distributor and will be sent out when your order is received. Other parts will be ordered, by your distributor, from Henny Penny Corporation. Normally, these will be sent to your distributor within three working days.

### **7-6. WARRANTY**

All replacement parts (except lamps and fuses) are warranted for 90 days against manufacturing defects and workmanship. If damage occurs during shipping, notify the carrier at once so that a claim may be properly filed. Refer to warranty in the front of this manual for other rights and limitations.

### **7-7. RECOMMENDED SPARE PARTS FOR DISTRIBUTORS**

Recommended replacement parts are indicated with A or B in the parts lists:

A = parts to be stocked on service vans or trucks

B = parts to be stocked at the distributor/KES location.

Inventory on all other parts not identified, should be based upon usage in the territory. Please use care when ordering recommended parts, because all voltages and variations are marked. Distributors should order parts based upon common voltages and equipment sold in their territory.

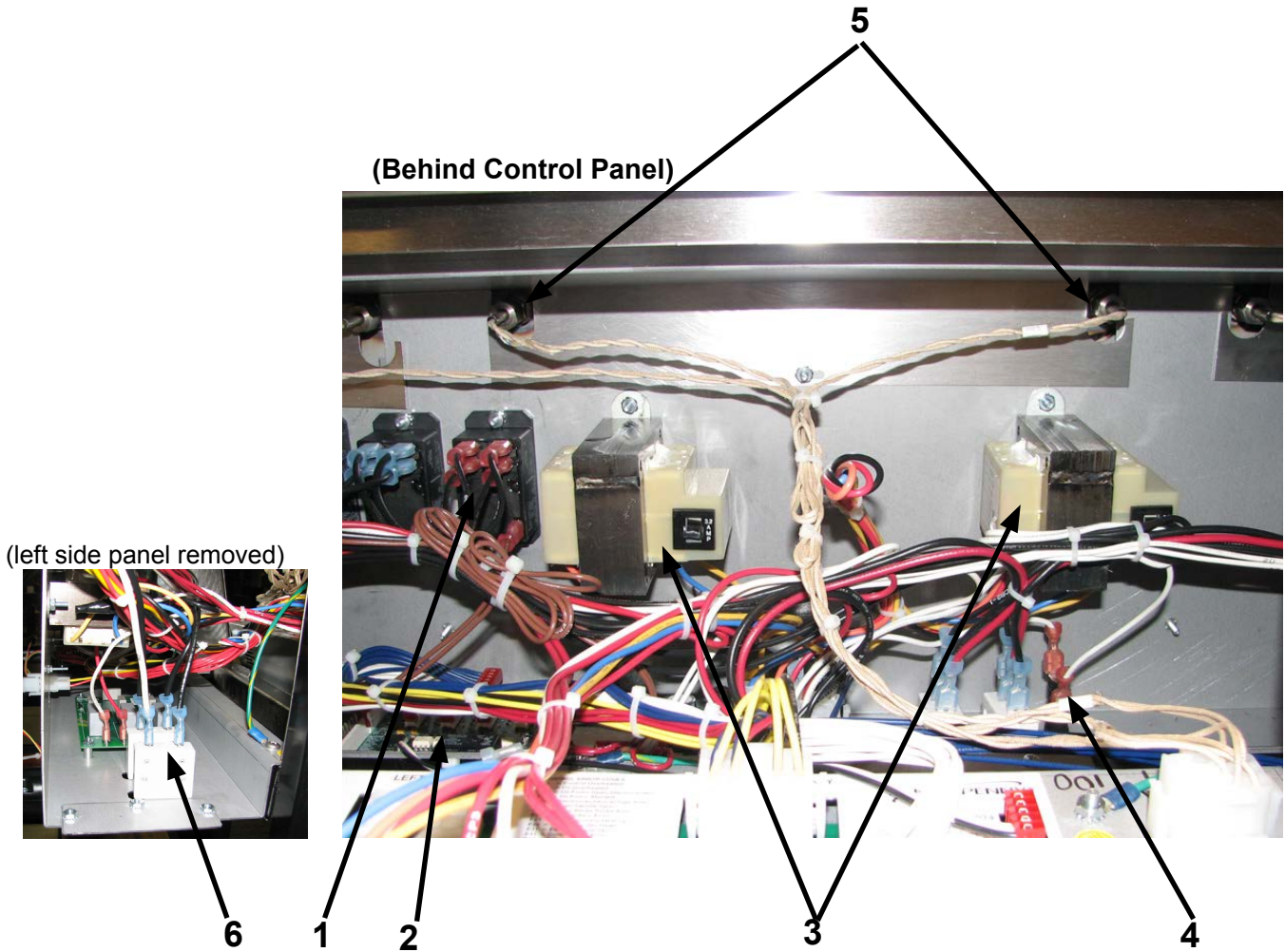

**Electrical Components**

Item No.	Part No.	Description	Quantity
B 1	ME90-008	RELAY - PUMP MOTOR- 12 VDC - 30 AMP .....	AR
B 2	84454RB	PC BOARD - EXPRESS FILTER .....	1
A 3	84134	TRANSFORMER-120V/75VA.....	1/vat**
A 4	EF02-104	FUSE HOLDER - 20A-250V .....	1
A	FA52-005	FUSE - .5 AMP (208/240V FRYERS).....	1
B 5	14974	LEVEL SENSOR - PROBES - 2.5 in.....	2/vat
A 6	EF02-125	BREAKER-PUSH BUTTON RESET - 15 AMP .....	AR

Recommend Parts: A=Truck Stock/B=Dist. Stock / \*not shown

AR=As Required

\*\*Only wells with the Express Filter PC board behind the control panel (as shown) has 2 transformers

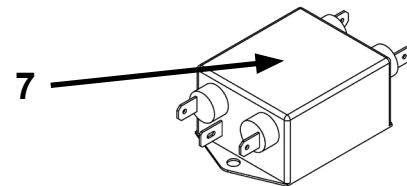
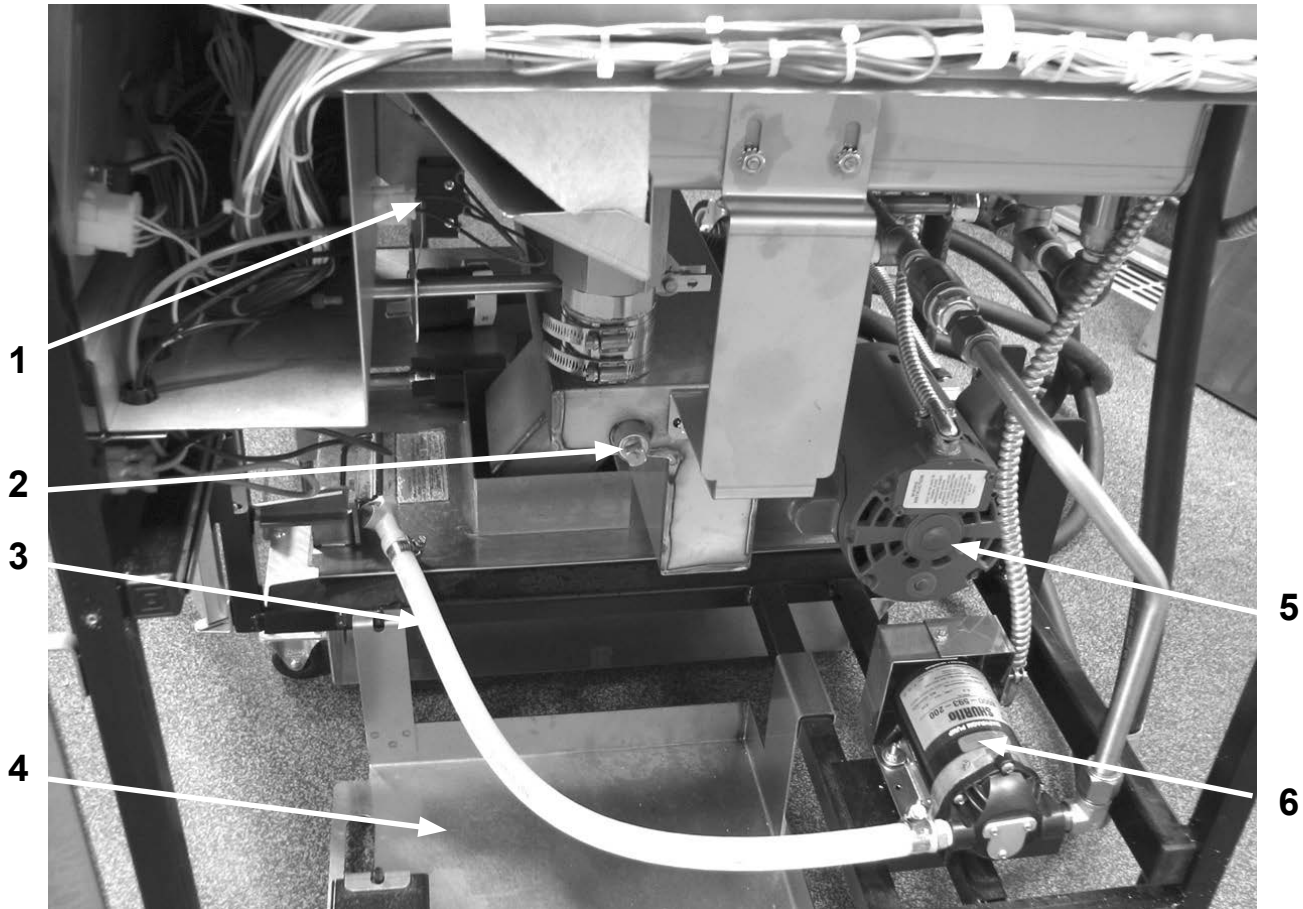

Recommend Parts: A=Truck Stock/B=Dist. Stock

### Right Side Panel Removed

Item No.	Part No.	Description	Quantity
1	81027	ASSY - LEVER SWITCH & BRACKET .....	1/vat
A	50764	MICROSWITCH - RIGID LEVER.....	1/vat
	81017	HARNES LEVER SWITCH .....	1/vat
	81495	BRACKET - LEVER SWITCH MOUNTING.....	1/vat
2	FP01-099	PLUG-PIPE 3/8 NPT SS .....	1
B 3	81513	ASSY - HOSE.....	1
4	85966	WELD ASSY - JIB SHELF .....	1
5	69356	PUMP & MOTOR ASSY. - 8GPM.....	1
A	67583	MOTOR - 1/2 HORSE.....	1
B	64218	PUMP - FILTER - 8 GPM .....	1
A	17476	SEAL KIT .....	1
B 6	74583	PUMP - OIL TOP OFF - 230V .....	1

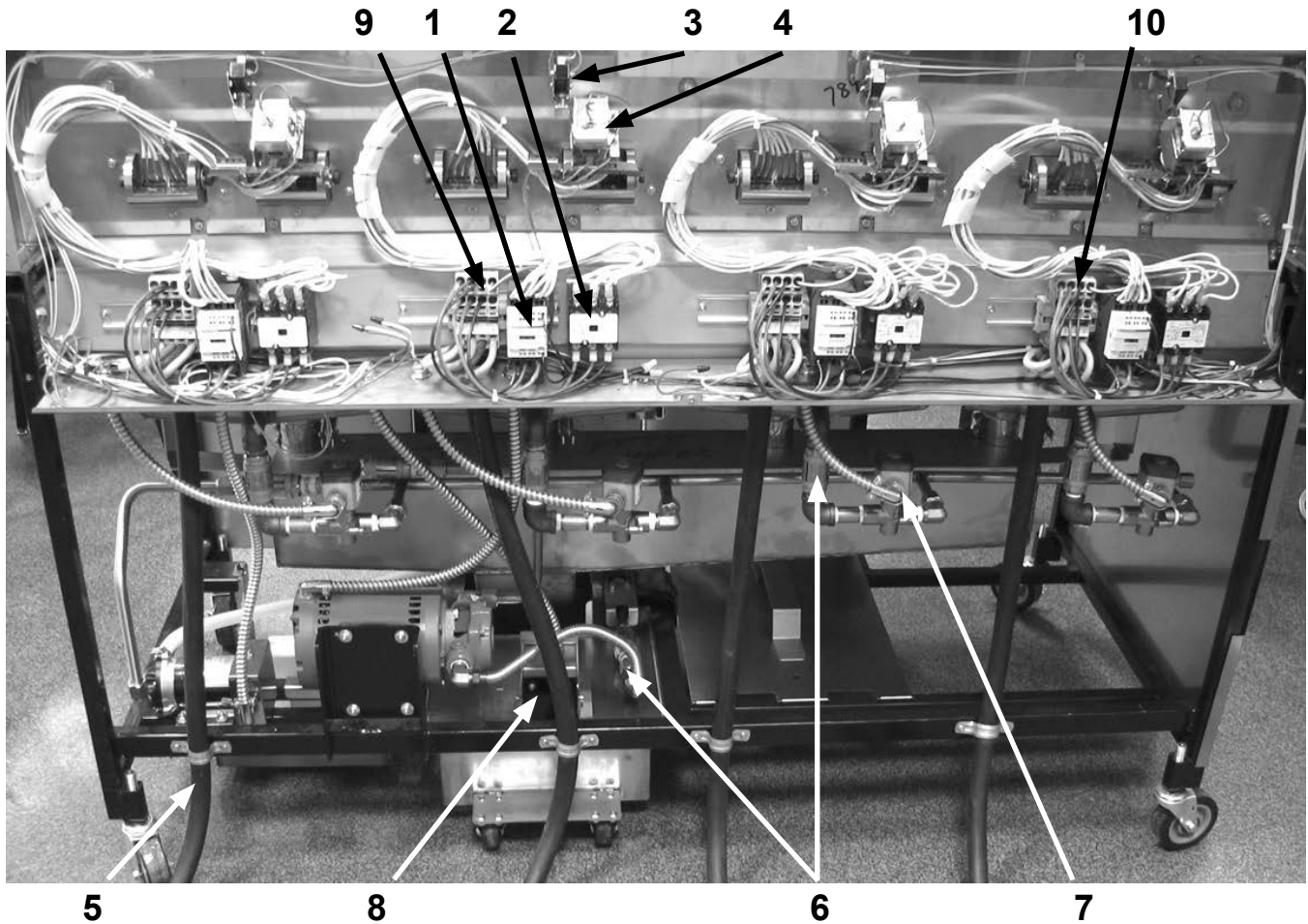

**Rear View**

Item No.	Part No.	Description	Quantity
A 1	78753	CONTACTOR - 24V COIL (Heat Contactor).....	1/vat
A 2	29509	CONTACTOR - 24V COIL (Primary Contactor) .....	1/vat
A 3	18227	SWITCH - ELEMENT LIFT .....	1/vat
A 4	140253	KIT - HIGH LIMIT - 425 F .....	1/vat
5	75381	ASSY - POWER CORD - 208-240V-60 AMP.....	1/vat
5	91786	ASSY - POWER CORD - 208-240V-60 AMP.....	1/vat
5	82087	ASSY - POWER CORD - 208-240V-50 AMP.....	1/vat
5	91787	ASSY - POWER CORD - 208-240V-50 AMP.....	1/vat
A 6	74469	VALVE - CHECK - 1/2" (Vat Fill).....	1/vat
A 7	74582	VALVE - SOLENOID 220-240V - 1/2N (Vat Fill Solenoids).....	1/vat
	140229	KIT-SOLENOID REPAIR.....	A/R
A 8	80148	ASSY-DRAIN SWITCH W/BOOT .....	1
B 9	78702	ASSY - TERMINAL BLOCK - DOM.....	1/vat
B 10	87033	ASSY-TERMINAL BLOCK-DOM (LEFT VAT ONLY-July 2010 & after)	1

Recommend Parts: A=Truck Stock/B=Dist. Stock

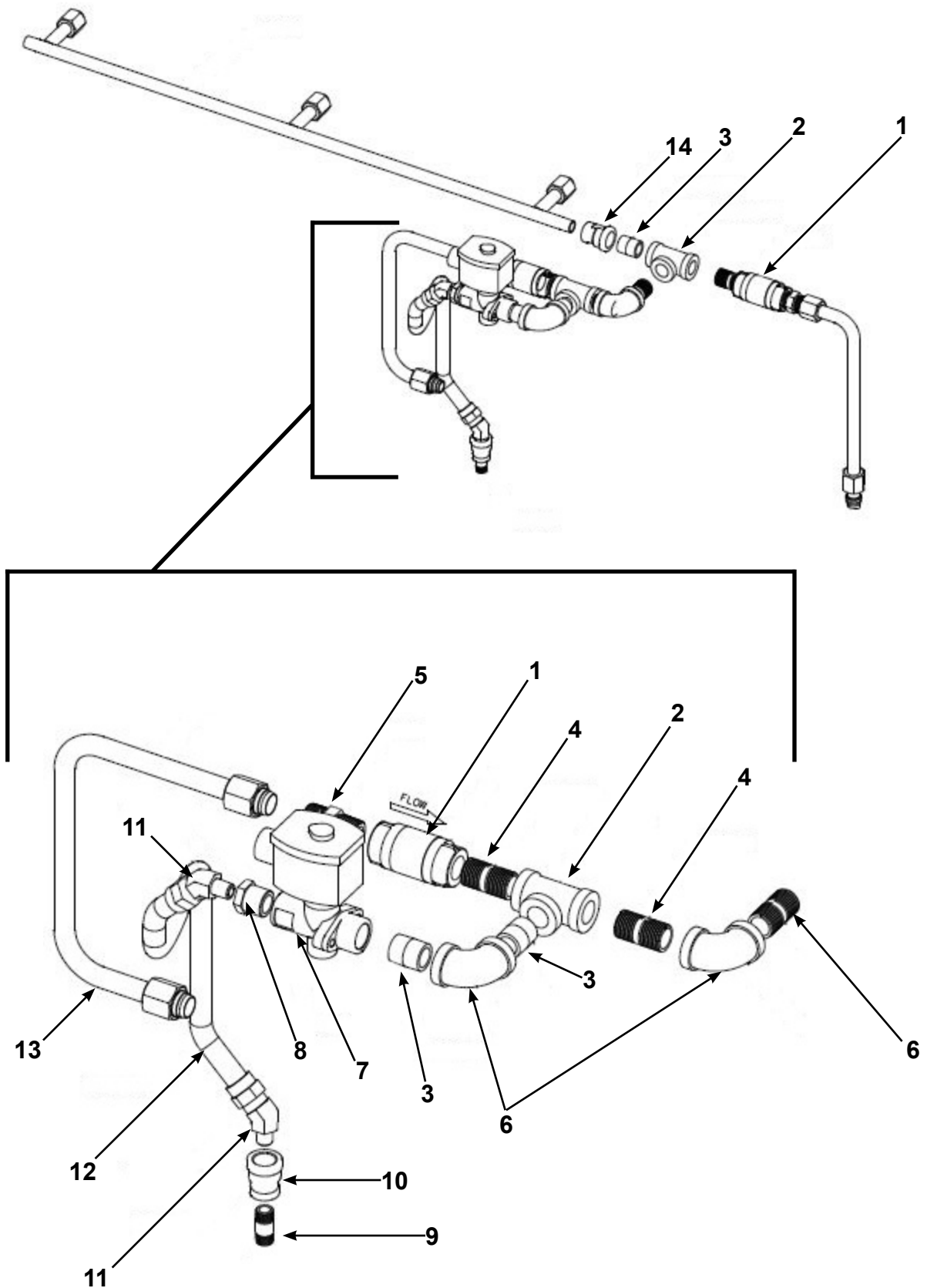

Item No.	Part No.	Description	Quantity
A 1	74469	VALVE - CHECK - 1/2" (Vat Fill).....	2
2	FP01-112	1/2 NPT FEMALE PIPE TEE BI.....	2
3	FP01-035	NIPPLE 1/2 NPT SS - 1 1/2 L.....	4
4	FP01-028	NIPPLE, CLOSE 1/2 NPT SS 1 LG.....	2
5	16807	FITTING CONNECTOR MALE.....	1
6	FP01-096	ELBOW-1/2 X 1/2 FEMALE SS.....	2
A 7	74582	VALVE-1/2 CHECK.....	1
8	FP01-029	REDUCER 1/2NPT M-3/8NPT F SS.....	1
9	56636	PIPE NIPPLE - 1/4NPT X 1.125.....	1
10	FP01-234	REDUCER-3/8 F TO 1/4 F B.I.....	1
11	FP01-240	ELBOW-45 DEG 3/8 NPT 45 FLARE.....	2
12	77523-011	TUBE-SUCTION DORMONT 10.000.....	1
13	80758	ASSY-LVE103 RETURN TUBE.....	1
14	FP01-122	REDUCER 3/8 TO 1/2 B.I.....	1

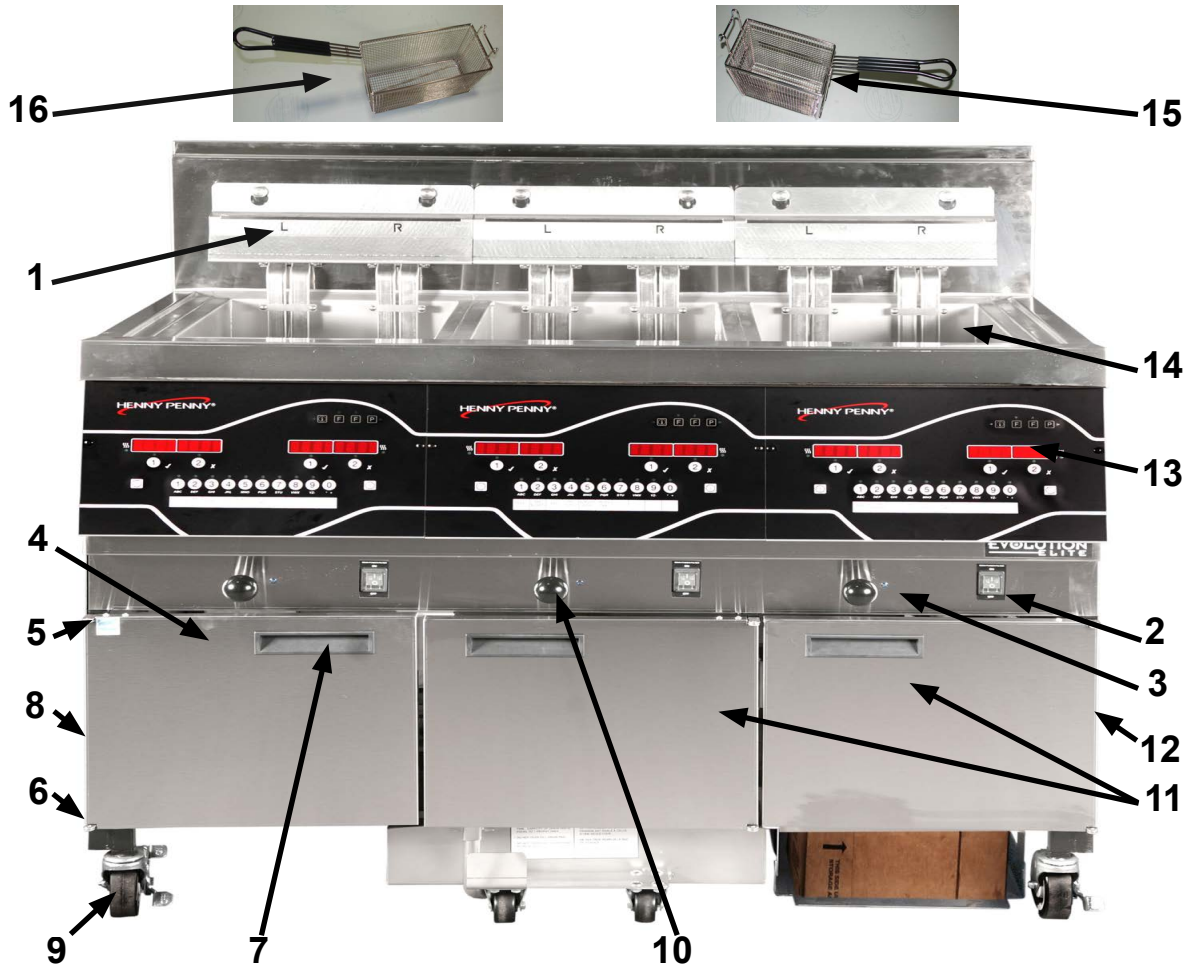

**Front View**

Item No.	Part No.	Description	Quantity
B 1	151171	HANGER-BASKET - EEE-15X .....	1/vat
A 2	52224	SWITCH - POWER.....	1/vat
B 3	81980	LED - 5 mm BLUE.....	1/vat
4	81185	ASSY-LH DOOR .....	1
4	81847	ASSY-LH DOOR - EEE-154 ONLY (not shown) .....	1
5	17618	TOP HINGE ASSY.....	1
6	17620	BOTTOM HINGE ASSY .....	1
7	41836	DOOR HANDLE.....	1
8	90668	PANEL - LH SIDE - EEE-15X.....	1
9	77575	CASTER - 4" - W/BRAKE .....	2
10	16101	KNOB - SPINDLE - BLACK.....	1/vat
11	81190	ASSY - RH DOOR .....	2
12	90669	PANEL - RH SIDE - EEE-15X.....	1
B 13	90785RB	ASSY - EEE15X CONTROL.....	1/vat
14	03624	WELD ASSY - COVER - FULL VAT .....	1/vat
15	83677	BASKET-SHORT - 1/2 SIZE - EEE-15X .....	2/vat
16	90582	BASKET-1/2 SIZE - EEE-15X.....	2/vat
17	77679	CASTER - 4" (not shown).....	2

Recommend Parts: A=Truck Stock/B=Dist. Stock

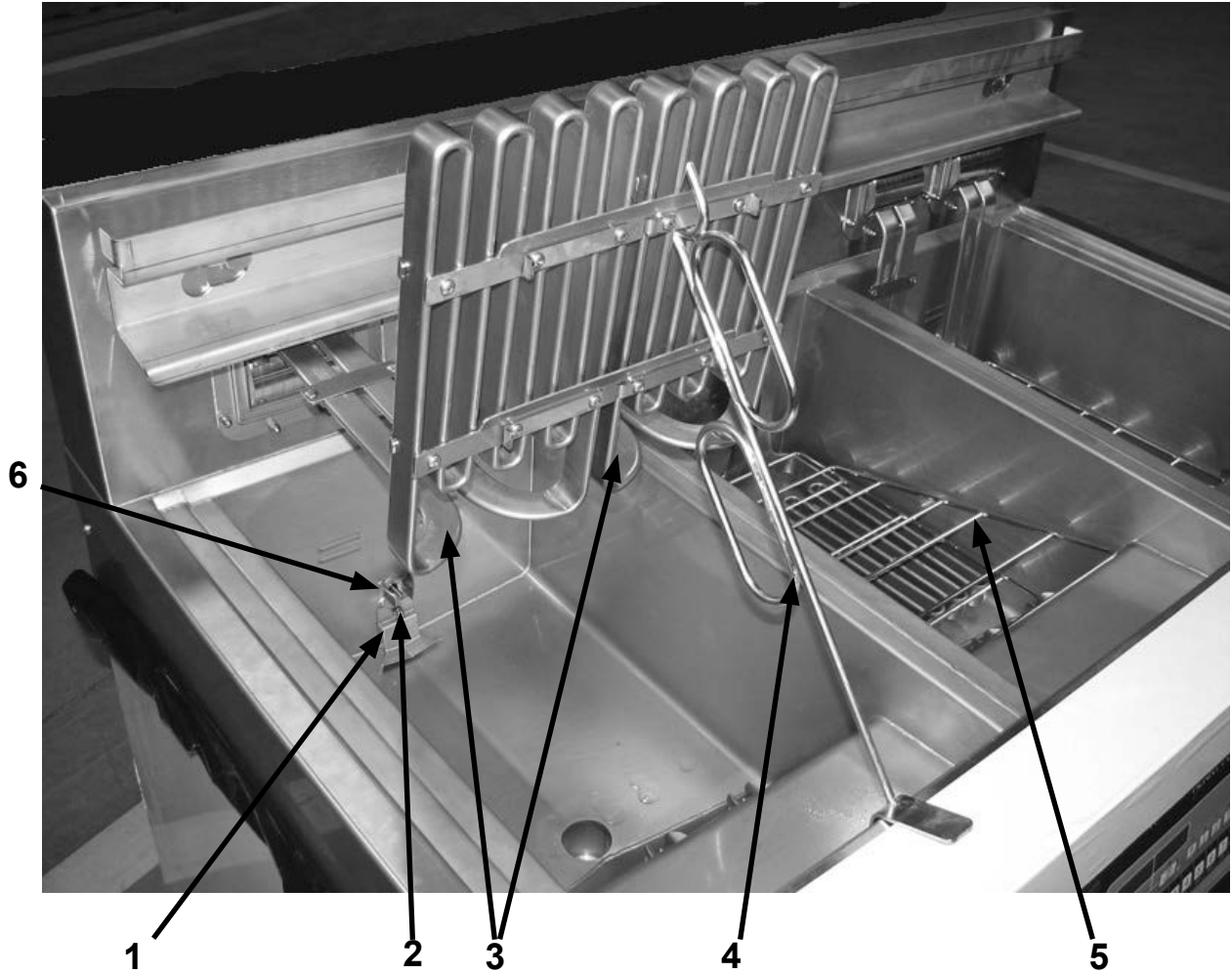

**Top View**

Item No.	Part No.	Description	Quantity
1	86010	WELD ASSY- OIL DIVERTER .....	1/vat
2	NS03-044	NUT - ACORN - #10-24 - SS.....	1/vat
B 3	78484-001	ELEMENT-HEATING - 7 KW-208V .....	2/vat
B 3	78484-006	ELEMENT-HEATING - 7 KW-240V .....	2/vat
B 4	74725	HANDLE - ELEMENT LIFT.....	1
B 5	74916	RACK - FULL VAT .....	1/vat
A 6	14984	PROBE - TEMPERATURE.....	1/vat
7	84921	DIVERTER - OIL FRONT (not shown) .....	2/vat

Recommend Parts: A=Truck Stock/B=Dist. Stock

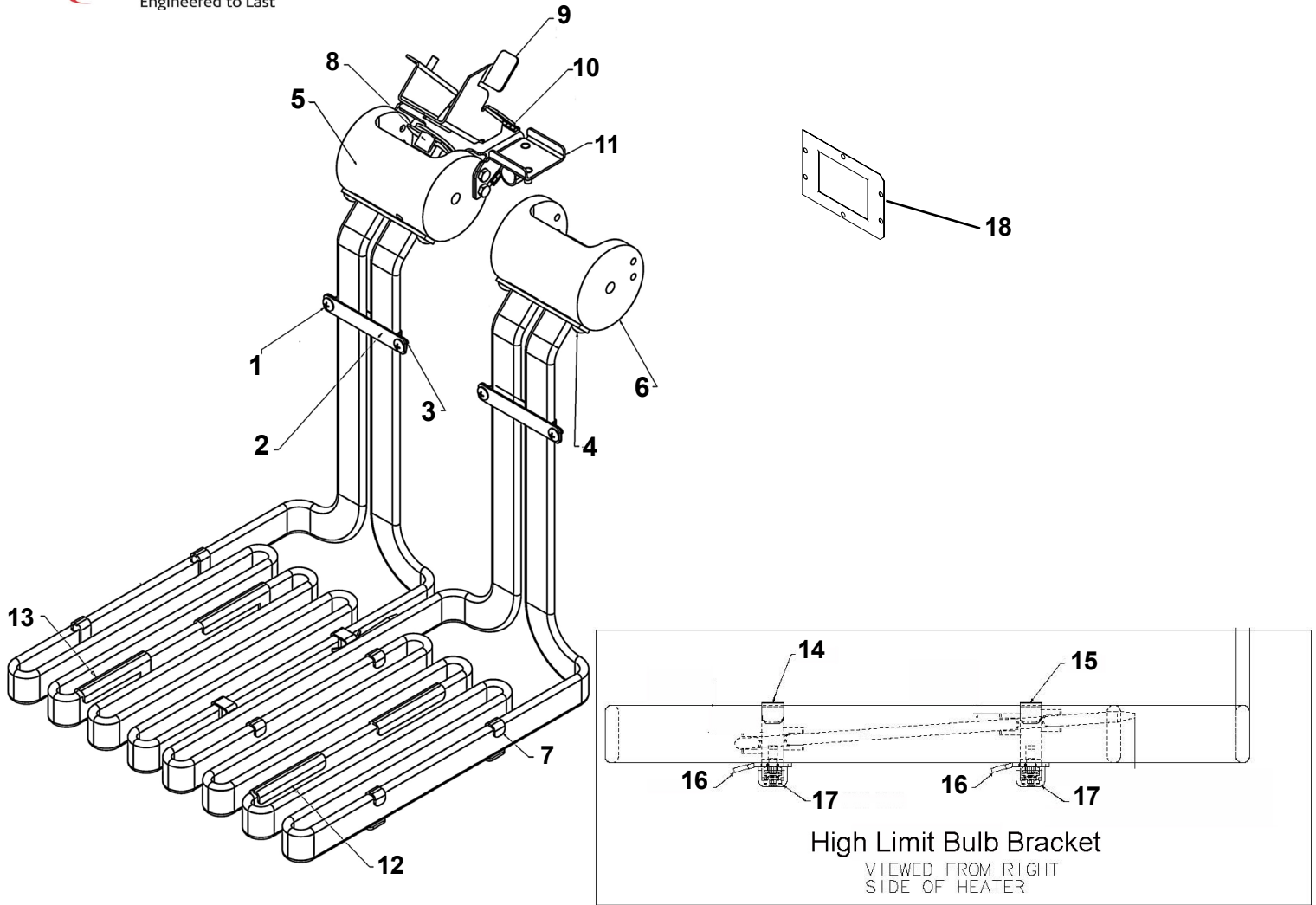

Item No.	Part No.	Description	Quantity
1	SC01-076	SCREW #8-32 X 1/4 PH THD S.....	2/vat
2	75819	PLATE - FRONT CAPILLARY.....	1/vat
3	75818	PLATE - REAR CAPILLARY.....	1/vat
4	SC01-074	SCREW #10-32 X 1/2 PH THD S.....	4/vat
5	74209	HOUSING - ELEMENT PIVOT.....	1/vat
6	82459	HOUSING - ELEMENT PIVOT - RH FULL.....	1/vat
7	78499	STRAP - SPREADER.....	6/vat
8	73713	WELD ASSY - HI LIMIT RESET PIN.....	1/vat
9	77147	WELD ASSY - PIVOT HI LIMIT BRACKET.....	1/vat
10	78780	BRACKET - HI LIMIT MOUNTING.....	1/vat
11	78896	STUD ASSY - GRND & WIRE MOUNTING.....	1/vat
12	85735	STRAP - SPREADER RH-EEE 14X-SN:BK0912003 & after.....	2/vat
13	85736	STRAP - SPREADER LH-EEE 14X-SN:BK0912003 & after.....	2/vat
14	78614	GUARD - FULL FRONT HI LIMIT.....	1/vat
15	78615	GUARD - FULL REAR HI LIMIT.....	1/vat
16	78494	WELD ASSY - SPREADER - FULL.....	2/vat
17	SC04-003	SCREW #8-32 X 3/8 PH PHD S.....	12/vat
B 18	76964	GASKET - PIVOT HUB.....	2/vat
A 19	OR01-004	O-RING (Fits on element against items #5 & 6) (not shown).....	2/element

Recommend Parts: A=Truck Stock/B=Dist. Stock

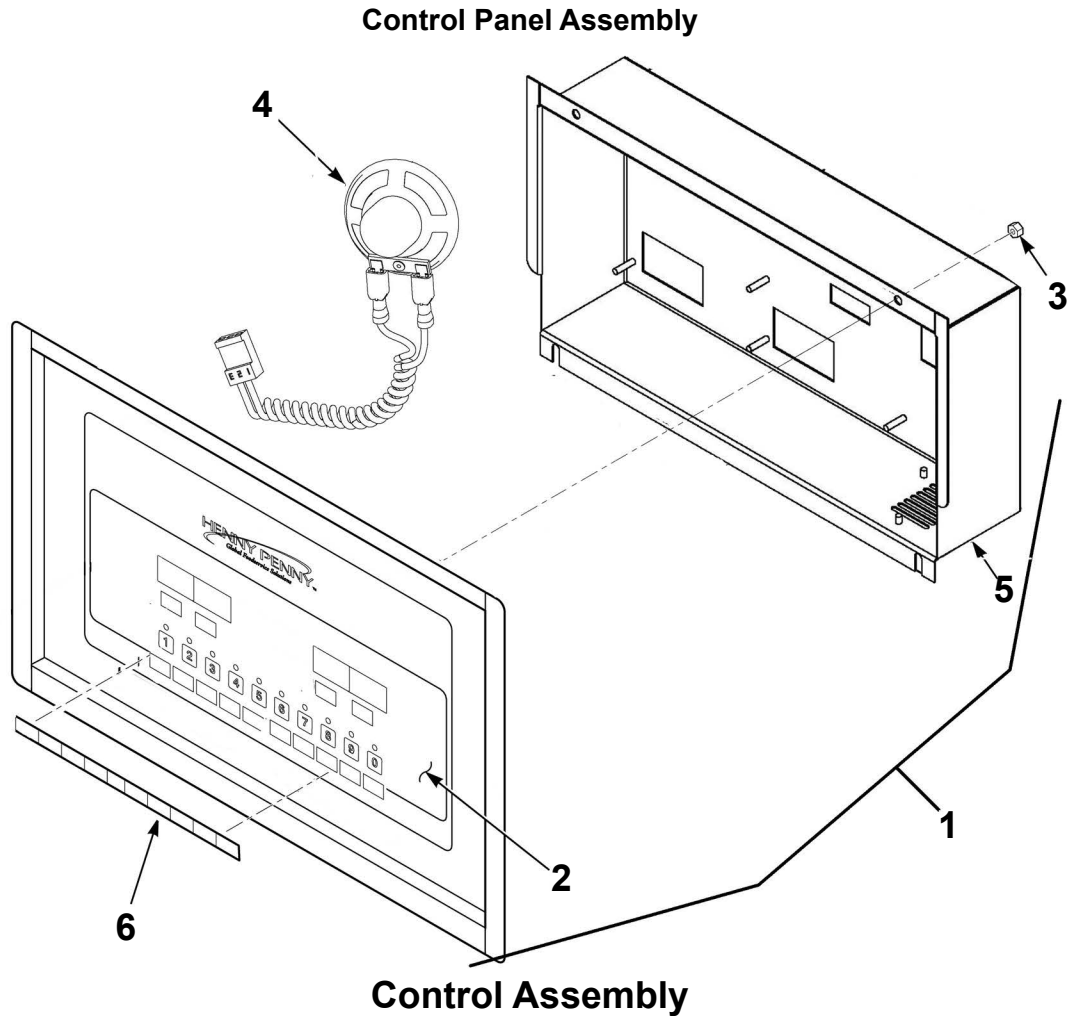

Item No.	Part No.	Description	Quantity
B 1	90785RB	ASSY - EEE15X CONTROL.....	1/vat
2	81354	DECAL - EVOLUTION ELITE® CONTROL.....	1/control
2	83206	DECAL - EE AUTO-LIFT CONTROL.....	1/control
3	NS02-005	NUT - HEX KEPS #6-32 C.....	23/control
B 4	26974	ASSY - SPEAKER.....	1/control
5	82085	STUD ASSY - CONTROL PANEL COVER.....	1/control
6	86293	MENU CARD - EVOLUTION - WENDY'S.....	1/control
6	81613	MENU CARD - BLANK - EVOLUTION.....	1/control
A 7	MS01-571	TOOL - TERMINAL EXTRACTOR (not shown).....	1
8	84910	ASSY - MMC/SD EVENT LOGGER (not shown).....	1

Recommend Parts: A=Truck Stock/B=Dist. Stock

# Wendy's

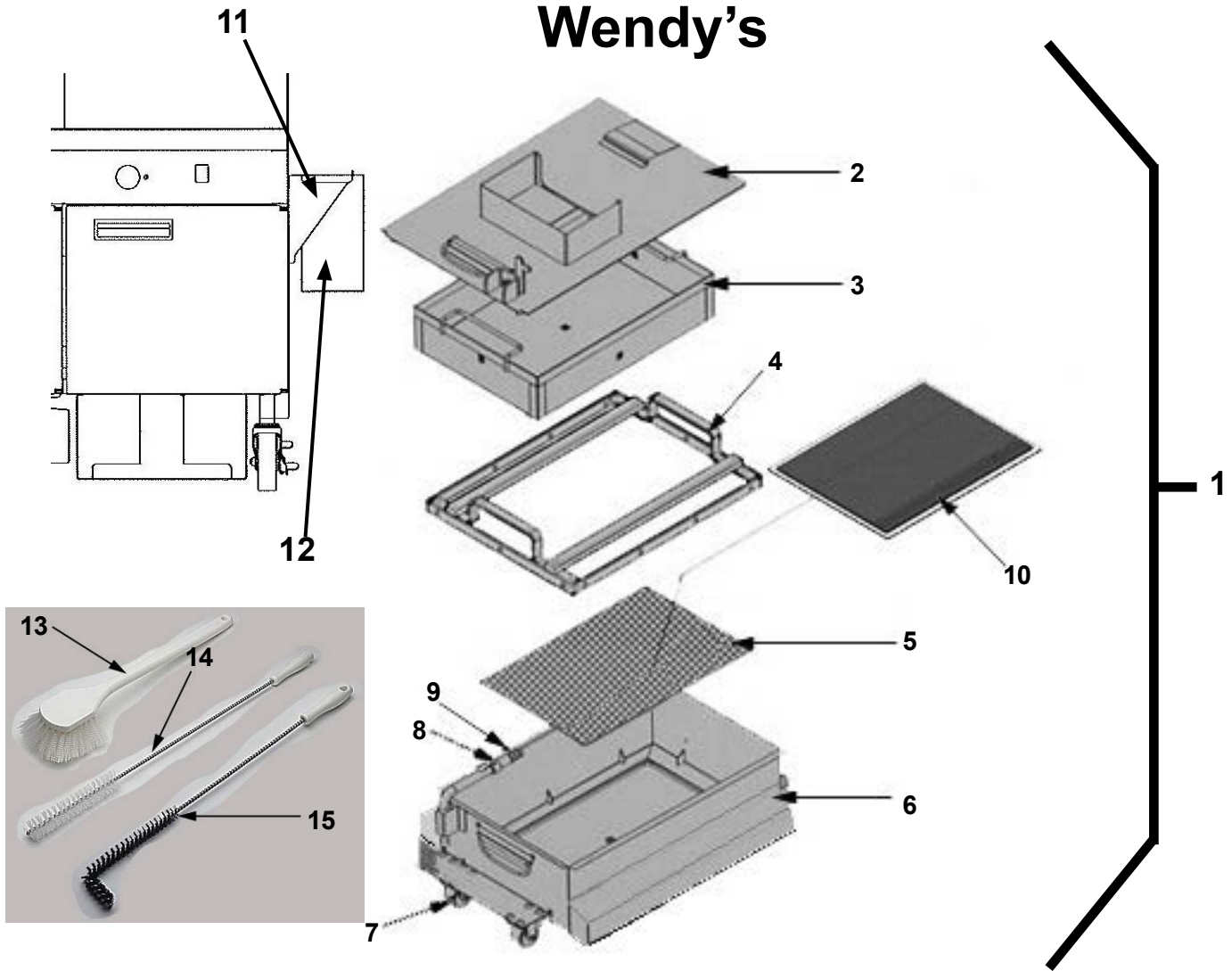

## EEE-15X Filter Pan Assembly, Brushes & Accessory Holder

Item No.	Part No.	Description	Quantity
1	91130	ASSY - WIDE DRAIN PAN .....	1
2	82673	ASSY-DRAIN PAN COVER.....	1
3	76259	WELD ASSY-CRUMB CATCHER .....	1
4	89416	WELD ASSY-FILTER WEIGHT .....	1
5	89420	FILTER-SECTION .....	1
6	89014	WELD ASSY-WIDE DRAIN PAN .....	1
7	52487	CASTER - FILTER PAN .....	4
8	85397	ADAPTOR - PUMP TO PICKUP TUBE.....	1
A 9	85401	O-RING-PICKUP TUBE.....	3
10	**	SPECIAL PLEATED FILTER .....	1
		** (Ordered through Wendy's supplier)	
11	83790	Bracket - Accessory Holder .....	1
12	83791	Holder - Accessory.....	1
B 13	12116	BRUSH - FRYER - LONG HANDLE .....	1
B 14	12112	BRUSH - STRAIGHT WHITE .....	1
B 15	12126	BRUSH - BLACK L.....	1

Recommend Parts: A=Truck Stock/B=Dist. Stock

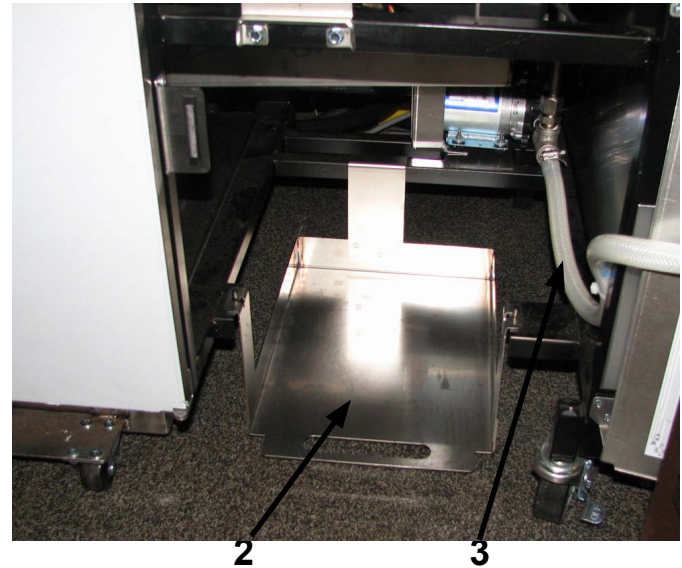

**BIB System**

Item No.	Part No.	Description	Quantity
B 1	86295	ASSY-BIB TUBE & QUICK DISC .....	1
2	85966	WELD ASSY - JIB SHELF .....	1
B 3	81513	ASSY - HOSE .....	1

Recommend Parts: A=Truck Stock/B=Dist. Stock

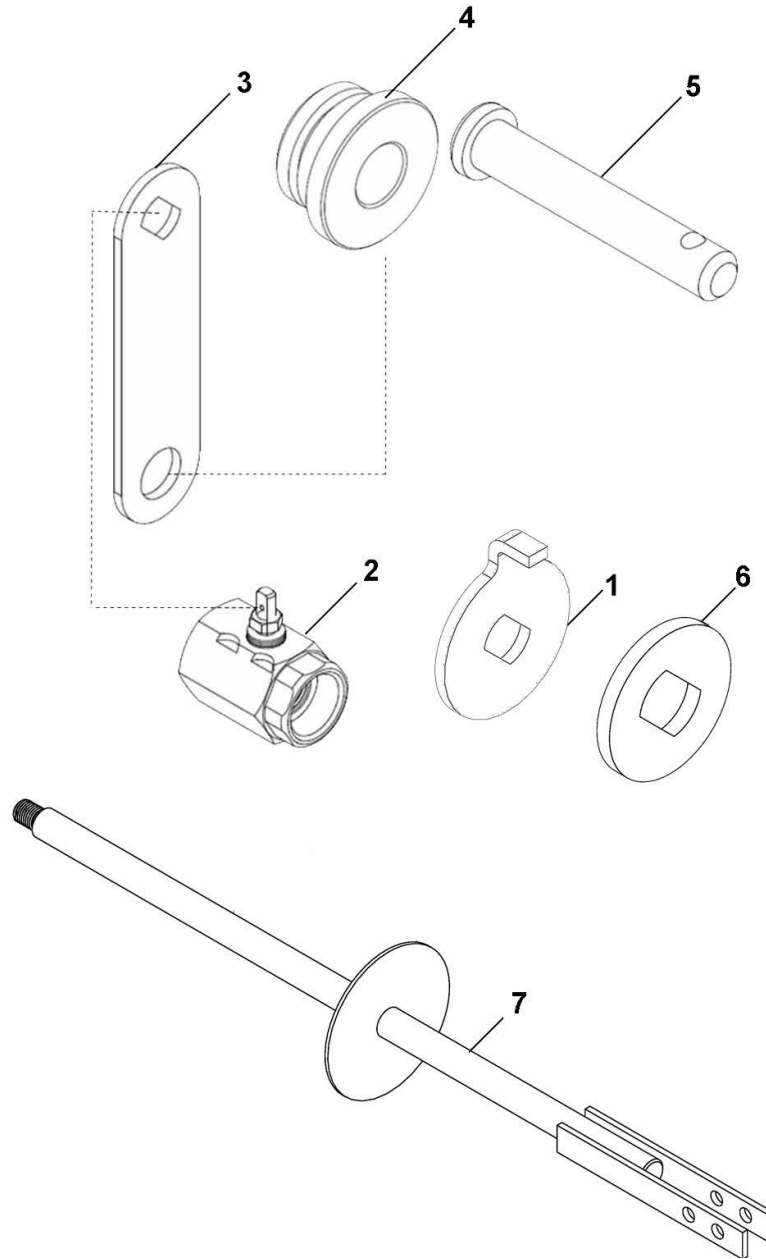

**Drain Valve Linkage Parts**

Item No.	Part No.	Description	Quantity
1	74626	STOP - PIVOT LINKAGE.....	1/vat
B 2	79590	VALVE-DRAIN 1.250 PORT W/O HDL .....	1/vat
A 3	73994	HANDLE - PIVOT - DRAIN.....	1/vat
4	74568	PIVOT - BUSHING - ACTUATOR.....	1/vat
B 5	PN01-012	PIN - CLEVIS - 1/4 x 1 IN SS.....	1/vat
6	74571	SPACER - PIVOT DRAIN HANDLE.....	1/vat
7	81183	ASSY - DRAIN EXTENSION ROD.....	1/vat
8	PN01-001	PIN - COTTER (not shown).....	1/vat

Recommend Parts: A=Truck Stock/B=Dist. Stock

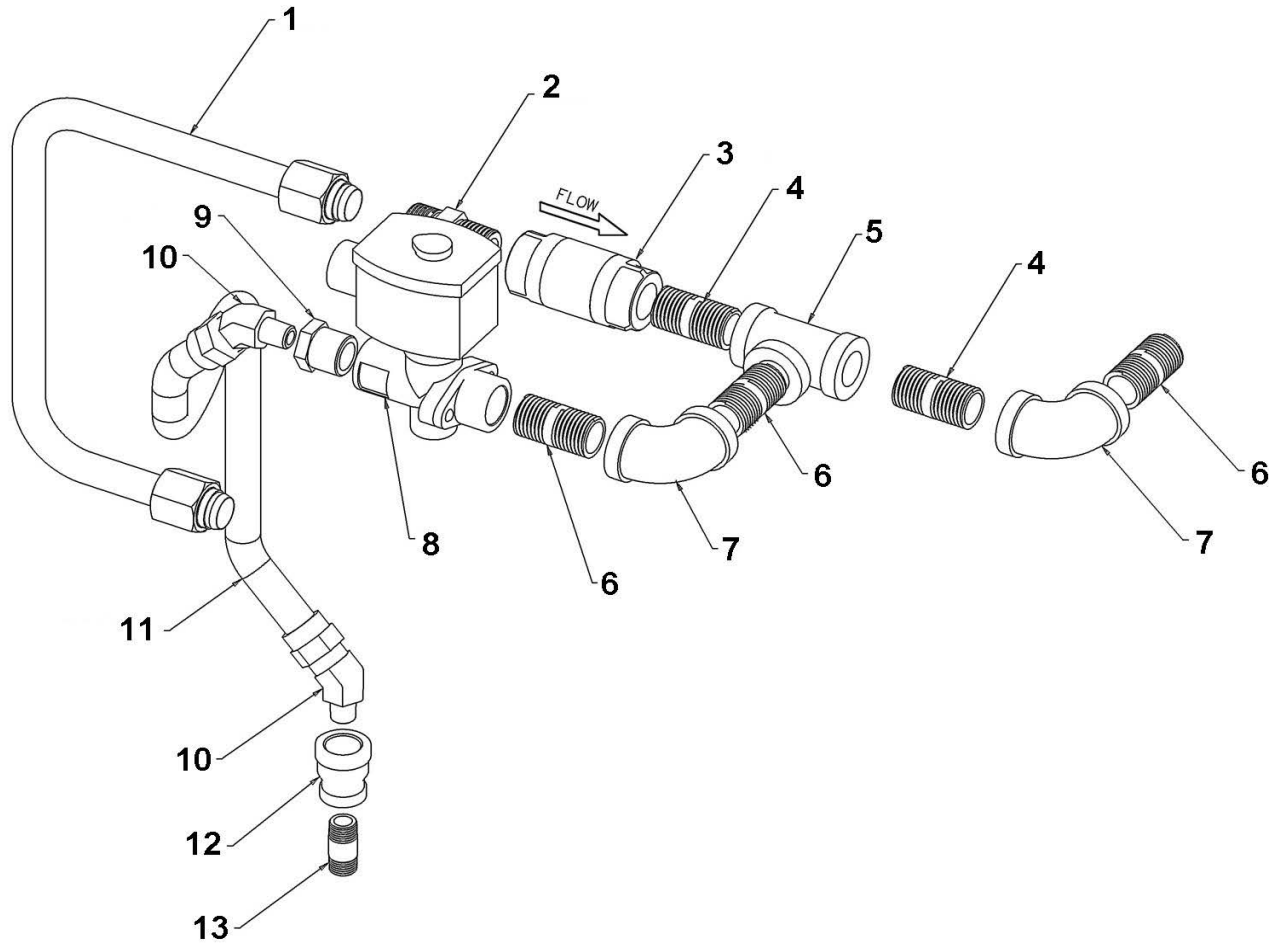

### Filter Return Line Assembly

Item No.	Part No.	Description	Quantity
1	80758	ASSY - RETURN LINE .....	1
2	16807	FITTING - CONNECTOR MALE .....	1
A 3	74469	VALVE - 1/2 CHECK .....	1
4	FP01-028	NIPPLE - CLOSE - 1/2 NPT - SS - 1 LG .....	2
5	FP01-112	1/2 NPT FEMALE PIPE TEE BI .....	1
6	FP01-035	NIPPLE -1/2 NPT - SS - 1-1/2 LG .....	3
7	FP01-096	ELBOW - 1/2 X 1/2 FEMALE SS .....	2
A 8	74582	VALVE - SOLENOID 220-240V - 1/2N .....	1
9	FP01-029	REDUCER - 1/2 NPT M-3/8 NPT F SS .....	1
10	FP01-240	ELBOW - 45 DEG 3/8 NPT 45 FLARE .....	2
11	77523-011	TUBE-SUCTION DORMONT 10.00 .....	1
12	FP01-234	REDUCER - 3/8 F TO 1/4 F BI .....	1
13	56636	PIPE NIPPLE - 1/4 NPT X 1.125 .....	1

Recommend Parts: A=Truck Stock/B=Dist. Stock

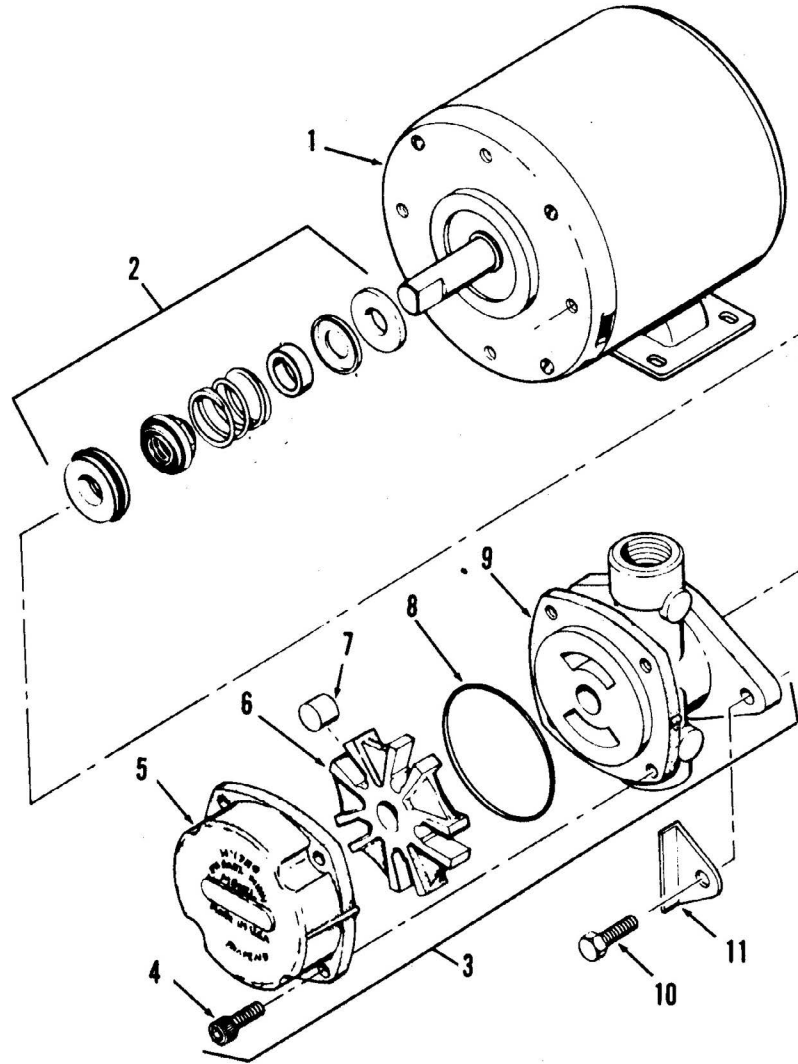

**Filter Motor and Pump**

Item No.	Part No.	Description	Quantity
A 1	67583	MOTOR, 1/2 HP - 50/60 Hz .....	1
A 2	17476	SEAL KIT .....	1
B 3	64218	PUMP - FILTER - 8 GPM .....	1
4	SC01-132	SCREW, Pump Cover .....	1
5	23470	CAP - 8 GPM PUMP .....	1
B 6	23468	ROTOR - 8 GPM PUMP .....	1
A 7	23469	ROLLER - 8 GPM PUMP .....	5
A 8	17453	O-RING.....	1
9	23467	BODY - 8 GPM PUMP.....	1
10	17456	SHIELD, Pump.....	2
11	SC01-026	SCREW, Pump Shield.....	1

Recommend Parts: A=Truck Stock/B=Dist. Stock

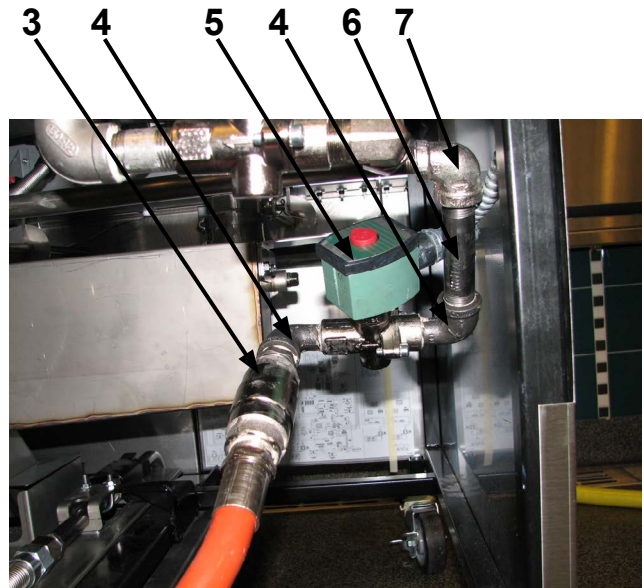
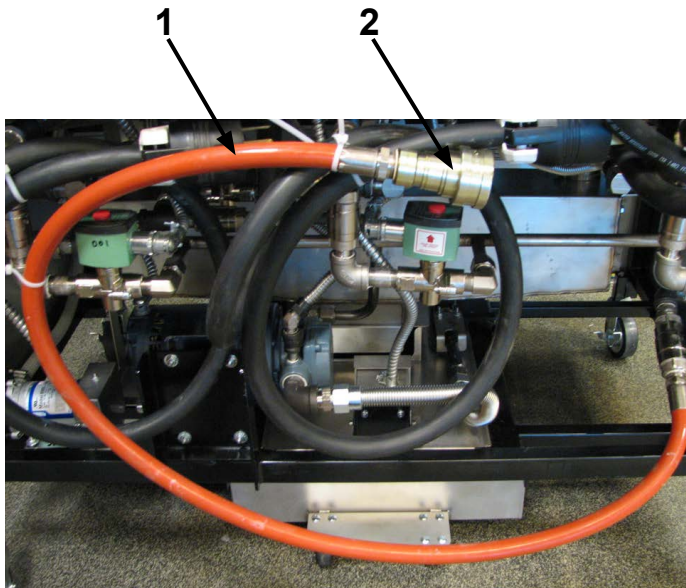

**Bulk Dispose**

Item No.	Part No.	Description	Quantity
*	140053	KIT - EEE BULK DISPOSE RETROFIT .....	1
B 1	67662	ASSY - DIRECT CONNECT HOSE .....	1
B 2	21612	DISCONNECT - FEMALE .....	1
B 3	21800	VALVE - 3/4 CHECK .....	1
4	FP01-088	ELBOW - STREET 1/2 X 90 BI .....	2
A 5	74582	VALVE - 220-240V - SOLENOID - 1/2 NPT .....	1
6	FP02-052	NIPPLE - 1/2 X 4 LG BI .....	1
7	FP01-001	ELBOW - REDUCING 1/2 TO 3/8 .....	1
B 8	21611	DISCONNECT - MALE (not shown) .....	1

Recommend Parts: A=Truck Stock/B=Dist. Stock

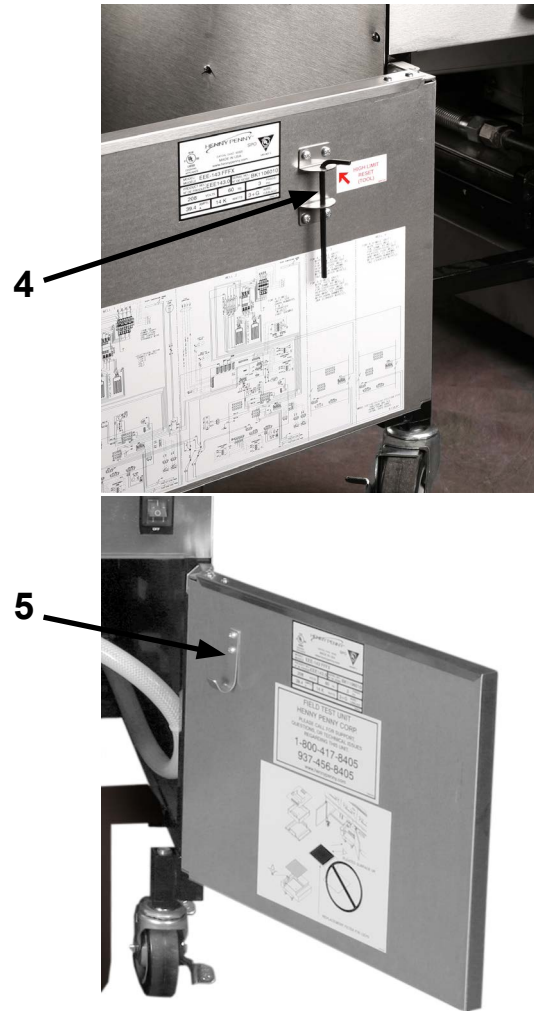
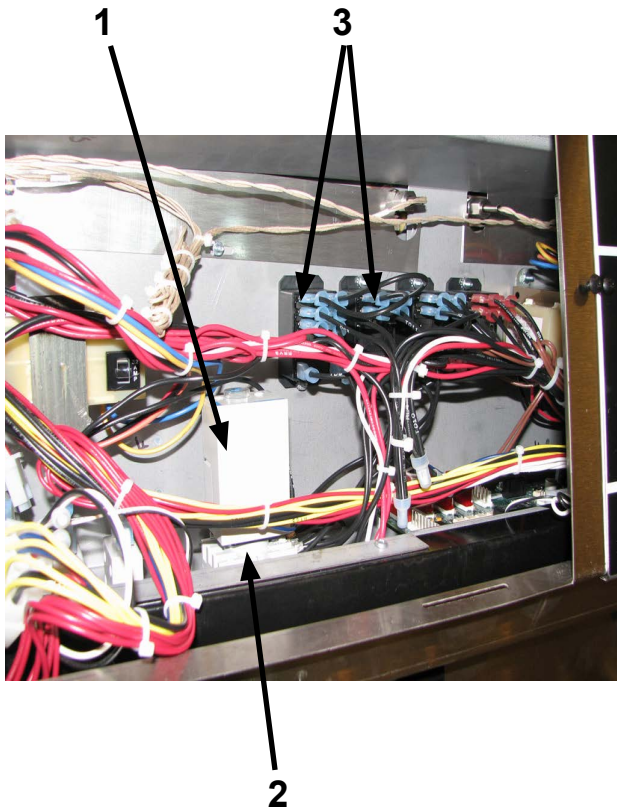

**Automatic Power Switching Components, High Limit Tool & PM Card Hook - EEE-15X**

Item No.	Part No.	Description	Quantity
B 1	92982	RELAY-DELAY TIMER 24-240VAC .....	1
2	92983	RELAY-BASE SOCKET .....	1
B 3	91727	RELAY-POWER DPDT 240VAC .....	2
A 4	12149	TOOL - HIGH LIMIT (ALLEN WRENCH-5/32) .....	1
5	91711	HOOK-CARD HOLDER WENDYS .....	1

Recommend Parts: A=Truck Stock/B=Dist. Stock