



TECHNICAL M A N U A L

Evolution Elite™

MODEL

EEG-163

EEG-164

HENNY PENNY
Engineered to Last™

REGISTER WARRANTY ONLINE AT WWW.HENNYPENNY.COM

SECTION 1: INTRODUCTION

1-1 SAFETY

The instructions in this manual have been prepared to aid you in learning the proper procedures for your equipment. Where information is of particular importance or is safety related, the words NOTICE, CAUTION, or WARNING are used. Their usage is described below.

If a problem occurs during the first operation of a new unit, recheck the Installation Section of the Operator's Manual.

Before troubleshooting, always recheck the Operation Section of the Operator's Manual.

Where information is of particular importance or is safety related, the words DANGER, WARNING, CAUTION, or NOTICE are used. Their usage is described as follows:



SAFETY ALERT SYMBOL is used with DANGER, WARNING or CAUTION which indicates a personal injury type hazard.



NOTICE is used to highlight especially important information.



CAUTION used without the safety alert symbol indicates a potentially hazardous situation which, if not avoided, may result in property damage.



CAUTION used with the safety alert symbol indicates a potentially hazardous situation which, if not avoided, could result in minor or moderate injury.



WARNING indicates a potentially hazardous situation which, if not avoided, could result in death or serious injury.



DANGER INDICATES AN IMMINENTLY HAZARDOUS SITUATION WHICH, IF NOT AVOIDED, WILL RESULT IN DEATH OR SERIOUS INJURY.

**1-2.
SAFETY
(CONT.)**



Equipotential Ground Symbol



Waste Electrical and Electronic Equipment (WEEE) Symbol

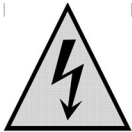

OR



Shock Hazard Symbols



OR



Hot Surface Symbols

SECTION 2: TROUBLESHOOTING

2-1. TROUBLE SHOOTING GUIDE

Problem	Cause	Correction
POWER switch ON but fryer completely inoperative	<ul style="list-style-type: none"> Open circuit 	<ul style="list-style-type: none"> Plug fryer in Check breaker or fuse at supply box
Control error code "E-10"	<ul style="list-style-type: none"> Oil temperature too high 	<ul style="list-style-type: none"> Let unit cool down (15-20 minutes), push up on metal reset button under right side of the controls; if high limit does not reset, high limit must be replaced 
Vat is under-filled	<ul style="list-style-type: none"> JIB is low or empty JIB oil line is clogged or collapsed Filter pan needs cleaned 	<ul style="list-style-type: none"> Fill the JIB Check JIB line Clean filter pan and change paper or pad

**2-1.
TROUBLE
SHOOTING GUIDE
(CONT.)**

Problem	Cause	Correction
Oil foaming or boiling over top of vat	<ul style="list-style-type: none"> • Water in oil • Improper or bad oil • Improper filtering • Improper rinsing after cleaning the vat 	<ul style="list-style-type: none"> • Drain and clean oil • Use recommended oil • Refer to filtering procedures • Clean and rinse vat and then dry thoroughly
Oil will not drain from vat	<ul style="list-style-type: none"> • Drain valve clogged with crumbs • Drain trough clogged 	<ul style="list-style-type: none"> • Open valve, force cleaning brush through drain • Remove right side panel and remove plug from end of trough and clean trough
Filter motor runs but pumps oil slowly	<ul style="list-style-type: none"> • Filter line connections loose • Filter paper or pad clogged • Filter not reassembled correctly 	<ul style="list-style-type: none"> • Tighten all filter line connections • Change filter paper or pad • Refer to assembly instructions on inside door
Bubbles in oil during entire filtering process	<ul style="list-style-type: none"> • Filter pan not completely engaged • Filter pan clogged • Damaged O-ring on filter line receiver on fryer 	<ul style="list-style-type: none"> • Make sure filter pan return line is pushed completely into the receiver on the fryer • Clean pan and change paper or pad • Change O-ring
Filter motor will not run	<ul style="list-style-type: none"> • The thermal reset button on the rear of the pump motor is tripped <div data-bbox="505 1310 875 1434" data-label="Image"> </div> <p>To prevent burns caused by splashing shortening, turn the unit's POWER switch to the OFF position before resetting the filter pump motor's manual reset protection device.</p>	<ul style="list-style-type: none"> • Remove the right side panel and allow time for the motor to cool and then, using a screwdriver, press hard against the button until it clicks <div data-bbox="940 1346 1435 1713" data-label="Image"> </div>

**2-2.
ERROR CODES**

In the event of a control system failure, the digital display shows an error message. The message codes are shown in the DISPLAY column below. A constant tone is heard when an error code is displayed, and to silence this tone, press any button.

DISPLAY	CAUSE	CORRECTION
“E-4”	<ul style="list-style-type: none"> Control board overheating 	Turn switch to OFF position, then turn switch back to ON; if display shows “E-4”, the control board is getting too hot; check the louvers on each side of the unit for obstructions
“E-5”	<ul style="list-style-type: none"> Oil overheating 	Turn switch to OFF position, then turn switch back to ON; if display shows “E-5”, the heating circuits and temperature probe should be checked
“E-6A”	<ul style="list-style-type: none"> Temperature probe open 	Turn switch to OFF position, then turn switch back to ON; if display shows “E-6A”, the temperature probe should be checked
“E-6B”	<ul style="list-style-type: none"> Temperature probe shorted 	Turn switch to OFF position, then turn switch back to ON; if display shows “E-6B”, the temperature probe should be checked
“E-10”	<ul style="list-style-type: none"> Hight limit 	<p>Let unit cool down (15-20 minutes), push up on metal reset button under right side of the controls; if high limit does not reset, high limit must be replaced</p> 
“E-15”	<ul style="list-style-type: none"> Drain switch 	Make sure drain knob is completely pushed-in; if E-15 persists, have drain switch checked
“E-18-A” “E-18-B” “E-18-C”	<ul style="list-style-type: none"> LH level sensor open RH level sensor open Both sensors open 	Turn switch to OFF position, then turn switch back to ON; if display still indicates a failed sensor, have the connectors checked at the control board; have sensor checked & replace if necessary

**2-2.
ERROR CODES
(CONT.)**

DISPLAY	CAUSE	CORRECTION
“E-20-A” “FAN SENSOR STUCK CLOSED”	<ul style="list-style-type: none"> • Pressure Switch failure • Wiring problem • I/O board failure 	<ul style="list-style-type: none"> • If fan is not running, have pressure switch checked; should be open circuit if no air pressure • If fan is running, wiring error, or relay on I/O board closed
“E-20-B” “NO DRAFT” “CHECK FAN”	<ul style="list-style-type: none"> • Pressure switch failure/ hose loose • Draft fan failure/ low voltage • Flue or hood obstruction 	<ul style="list-style-type: none"> • Press power button to vat off and back on again, if E-20-B persists, have pressure switch checked; should be open circuit if no air pressure; make sure hose is connected to fan and pressure switch • Have draft fan checked; low voltage going to fan • Check the fryer flue and hood system for obstructions
“E-20-D” IGNITION FAILURE”	<ul style="list-style-type: none"> • Failure to ignite/ no flame sense 	<ul style="list-style-type: none"> • Press power button to vat off and back on again, if E-20-D persists, check gas line connections; check gas shut-off valve; have ignition module checked; gas valve checked; flame sensor gap checked; gas valve and ignition module wiring checked
“E-21”	<ul style="list-style-type: none"> • Slow heat recovery 	<ul style="list-style-type: none"> • Have a certified service technician check the fryer for correct voltage to the unit; have heat circuit checked; have unit checked for loose or burnt wire
“E-22” “NO HEAT” “CHECK GAS VALVE”	<ul style="list-style-type: none"> • Burner not igniting 	<ul style="list-style-type: none"> • Have gas valve and heat circuit checked
“E-41 “ / “E-46”	<ul style="list-style-type: none"> • Programming failure 	<ul style="list-style-type: none"> • Press power button to vat off and back on again, if any of the error codes, have the controls re-initialized; if error code persists, have the control board replaced
“E-47”	<ul style="list-style-type: none"> • Analog converter chip or 12 volt supply failure 	<ul style="list-style-type: none"> • Press power button to vat off and back on again, if “E-47” persists, have the I/O board, or the PC board replaced; if speaker tones are quiet, probably I/O board failure; have the I/O board replaced
“E-48”	<ul style="list-style-type: none"> • Input system error 	<ul style="list-style-type: none"> • Have PC board replaced
“E-54-C”	<ul style="list-style-type: none"> • Temperature input error 	<ul style="list-style-type: none"> • Turn switch to OFF, then back to ON; have control PC board replaced if “E-54C” persists
“E-60” “FILTER IN USE”	<ul style="list-style-type: none"> • AIF PC board not communicating with control PC board 	<ul style="list-style-type: none"> • Press power button to turn vat off, wait 15 seconds, and turn back on again. If “E-60” persists, have connector between the PC boards checked; replace AIF PC board or control PC board, if necessary
“E-70C”	<ul style="list-style-type: none"> • Drain valve jumper wire missing or disconnected 	<ul style="list-style-type: none"> • Have the jumper wire checked on the PC board at drain switch interlock position
“E-83-A”	<ul style="list-style-type: none"> • Pressure too high 	<ul style="list-style-type: none"> • Check filter system in Vat #1
“E-83-B”	<ul style="list-style-type: none"> • Pressure too high 	<ul style="list-style-type: none"> • Check filter system in Vat #2

**2-2.
ERROR CODES
(CONT.)**

DISPLAY	CAUSE	CORRECTION
"E-83-C"	<ul style="list-style-type: none"> • Pressure too high 	<ul style="list-style-type: none"> • Check filter system in Vat #3
"E-83-D"	<ul style="list-style-type: none"> • Pressure too high 	<ul style="list-style-type: none"> • Check filter system in Vat #4
"E-83-E"	<ul style="list-style-type: none"> • Pressure too high 	<ul style="list-style-type: none"> • Check filter system in Vat #5
"E-83-J"	<ul style="list-style-type: none"> • Bulk JIB FILL switch ON when pressure too high 	<ul style="list-style-type: none"> • Check JIB fill valves
"E-83-R"	<ul style="list-style-type: none"> • Bulk Dispose switch ON when pressure too high 	<ul style="list-style-type: none"> • Check Bulk Dispose quick-disconnect behind fryer
"E-93-1" "24 VDC SUPPLY TRIPPED"	<ul style="list-style-type: none"> • Autolift motor malfunction or failure 	<ul style="list-style-type: none"> • If AutoLift feature is not operating, have each of the AutoLift motors checked.

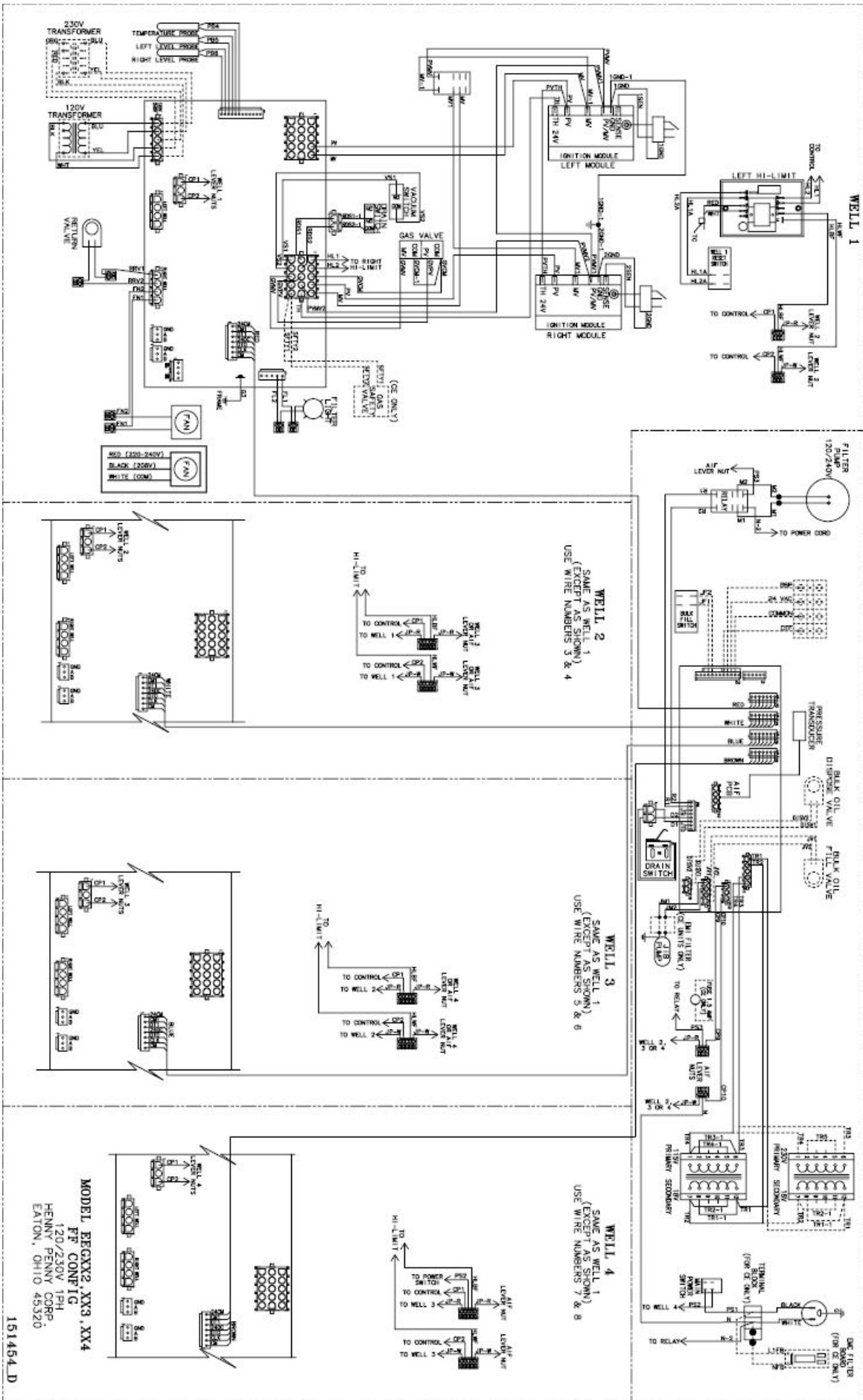

DIAG-120/230/1-BEG FF CONFIG

151454.D

MODEL EFGXX2, XX3, XX4
FF CONFIG
120/230V 1PH
HENNY PENNY CORP.
EATON, OHIO 45320

SECTION 3: PARTS

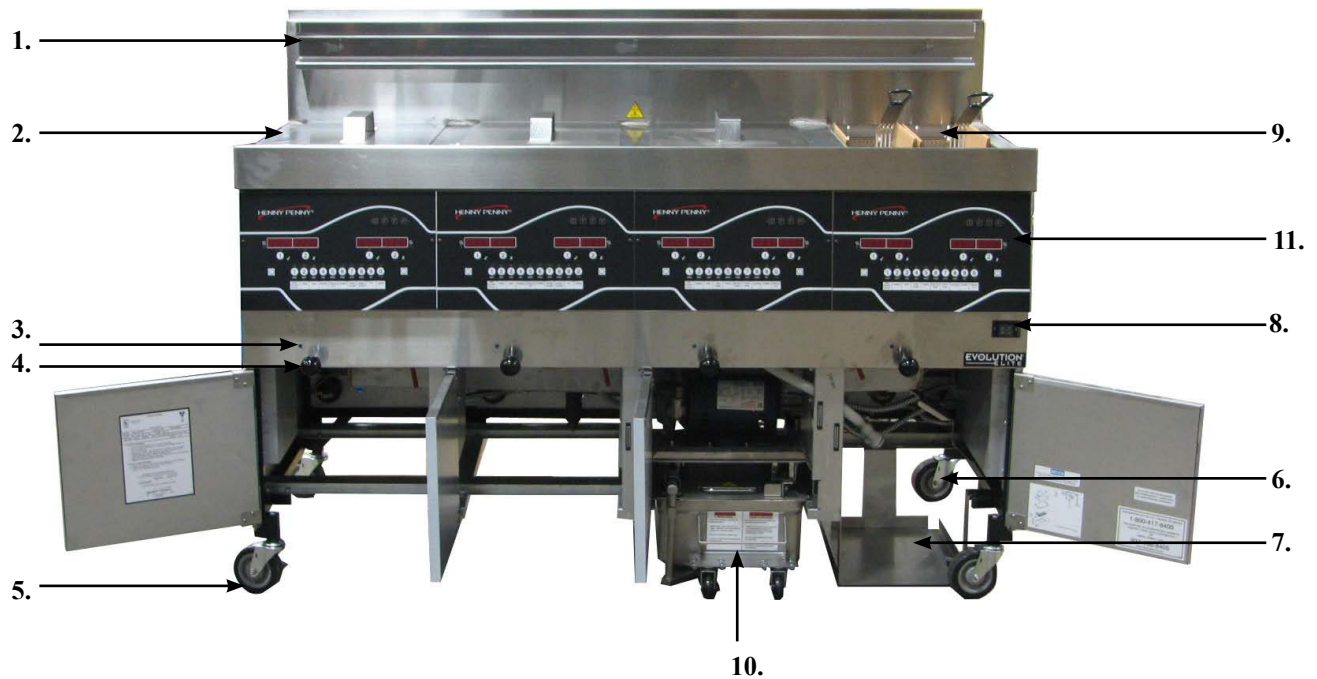

Item No.	Part No.	Description	Quantity
1	152508	HANGER-BASKET-EEGXX4	1/ 4-well
1	152793	HANGER-BASKET-EEGXX3	1/ 3-well
2	76555	WELD ASSY-COVER FULL	1/vat
3	81980	LED-5MM BLUE	1/vat
4	-----	DRAIN KNOB ASSEMBLY..... --See DRAIN KNOB drawing for breakdown	1/vat
5	77575	CASTER-SWIVEL W/ BRAKE (front).....	2
6	77679	CASTER-SWIVEL W/O BRAKE (back)	2
7	151704	STUD ASSY-JIB SHELF	1
8	52224	COVERED POWER SWITCH	1
9	81915	BASKET-1/2 SIZE BLK FRONT SUPP.....	A/R
9	85136	BASKET-FULL SIZE BLACK FR SPRT.....	A/R
10	152634	DRAIN PAN ASSY	1
11	96687	ASSY-CHILI CONTROL-EEX16X	1/well
11	96862	ASSY-MAGGIANO CONTROL-EEX16X.....	1/well

Recommend Parts: A=Truck Stock/B=Dist. Stock / *not shown/ A/R=As Required

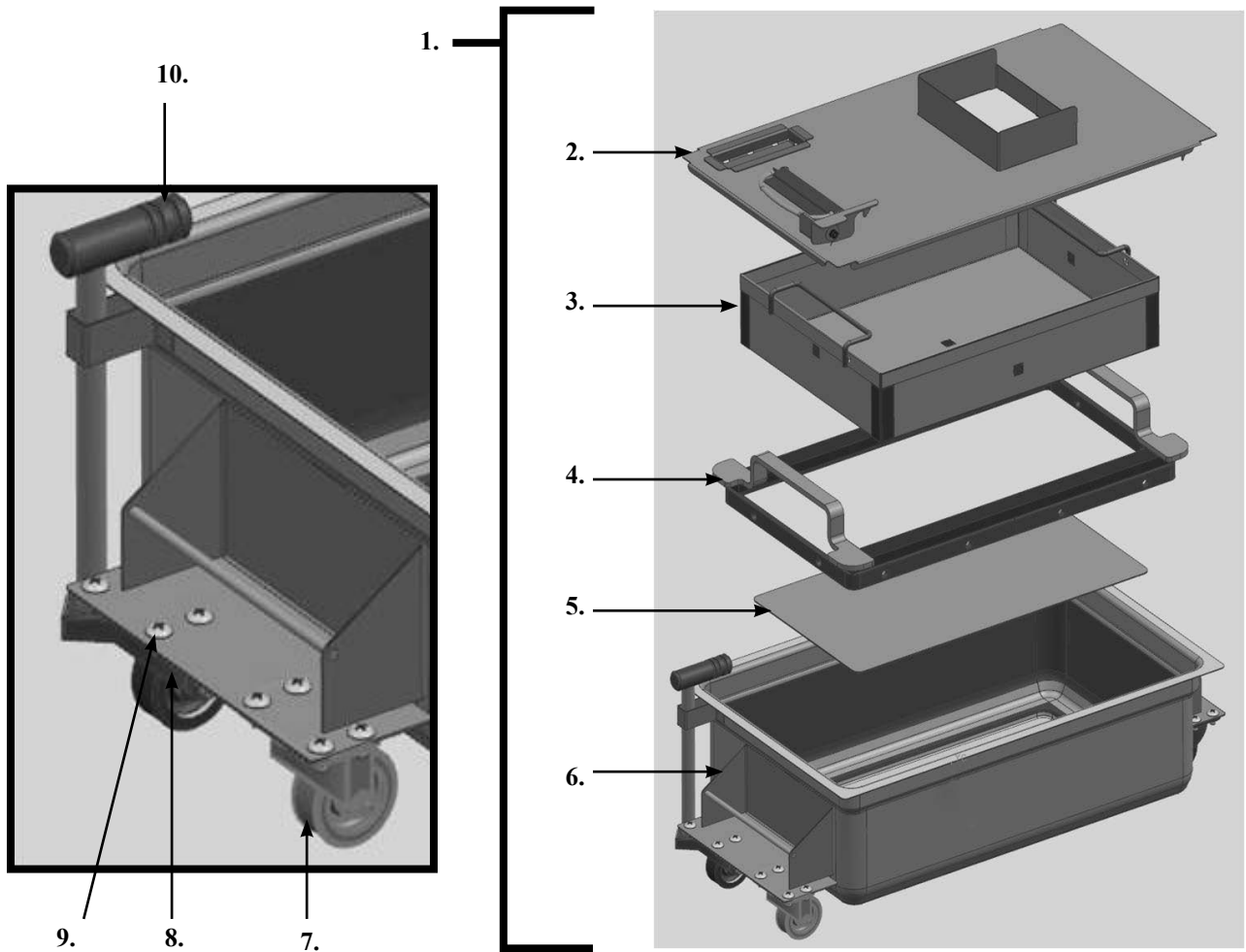

Item No.	Part No.	Description	Quantity
1	152634	ASSY-EEG-16X DRAIN PAN W/ CASTER.....	1
2	152635	--ASSY-EEG-16X DRAIN PAN COVER	1
3	85507	--WELD ASSY-CRUMB CATCHER	1
4	85503	--WELD ASSY-FILTER WEIGHT	1
5	85519	--FILTER SECTION	1
6	95842	--ASSY-DRAIN PAN	1
7	19004	----CASTER-SWIVEL 2IN	4
8	SC01-009	----SCREW 1/4-20 X 1/2 THD	4/wheel
9	NS04-005	----LOCKNUT1/4-20	4/wheel
10	86349	O-RING-116 SUCTION LINE	3

Recommend Parts: A=Truck Stock/B=Dist. Stock / *not shown/ A/R=As Required

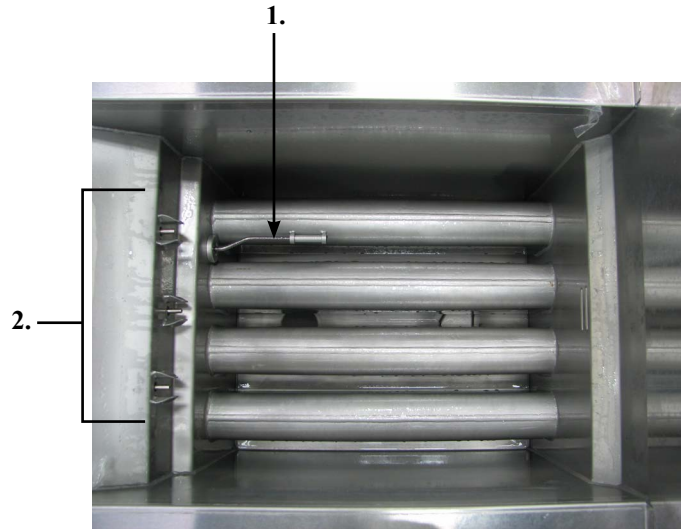

Item No.	Part No.	Description	Quantity
A 1	92717	THERMOCOUPLE- HIGH LIMIT	1/vat
2	87739	ASSY-PROBE	1/well

EEG-164 Door Break Down

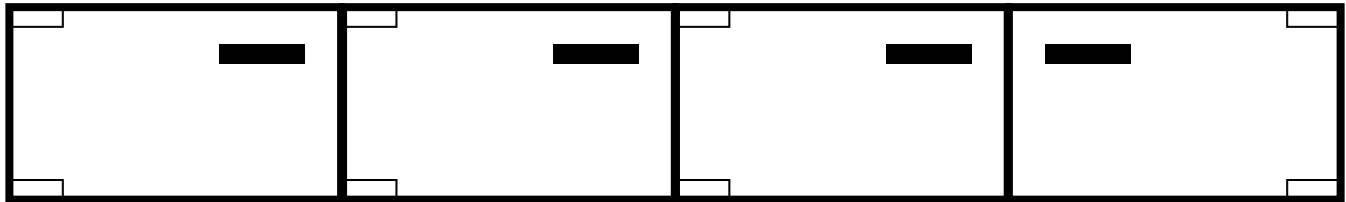

150300 ASSY-LH DOOR (long)	93355 ASSY-LH DOOR (short)	93355 ASSY-LH DOOR (short)	93356 ASSY-RH DOOR
----------------------------------	----------------------------------	----------------------------------	-----------------------

EEG-163 Door Break Down

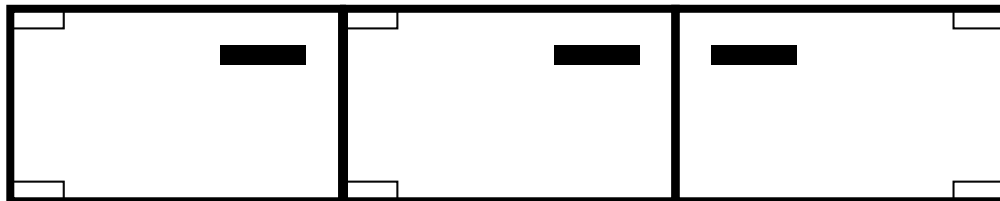

150300 ASSY-LH DOOR (long)	93355 ASSY-LH DOOR (short)	93356 ASSY-RH DOOR
----------------------------------	----------------------------------	-----------------------

Door Hinge Chart

Door	Top Hinge (Door)	Bottom Hinge (Door)	Bottom Hinge (Frame)	Bushing
150300	93370	93369	150624	39752
93355	93370	93369	85409	39752
93355	93370	93369	85409	39752
93356	93369	93370	150625	39752

Recommend Parts: A=Truck Stock/B=Dist. Stock / *not shown/ A/R=As Required

4.

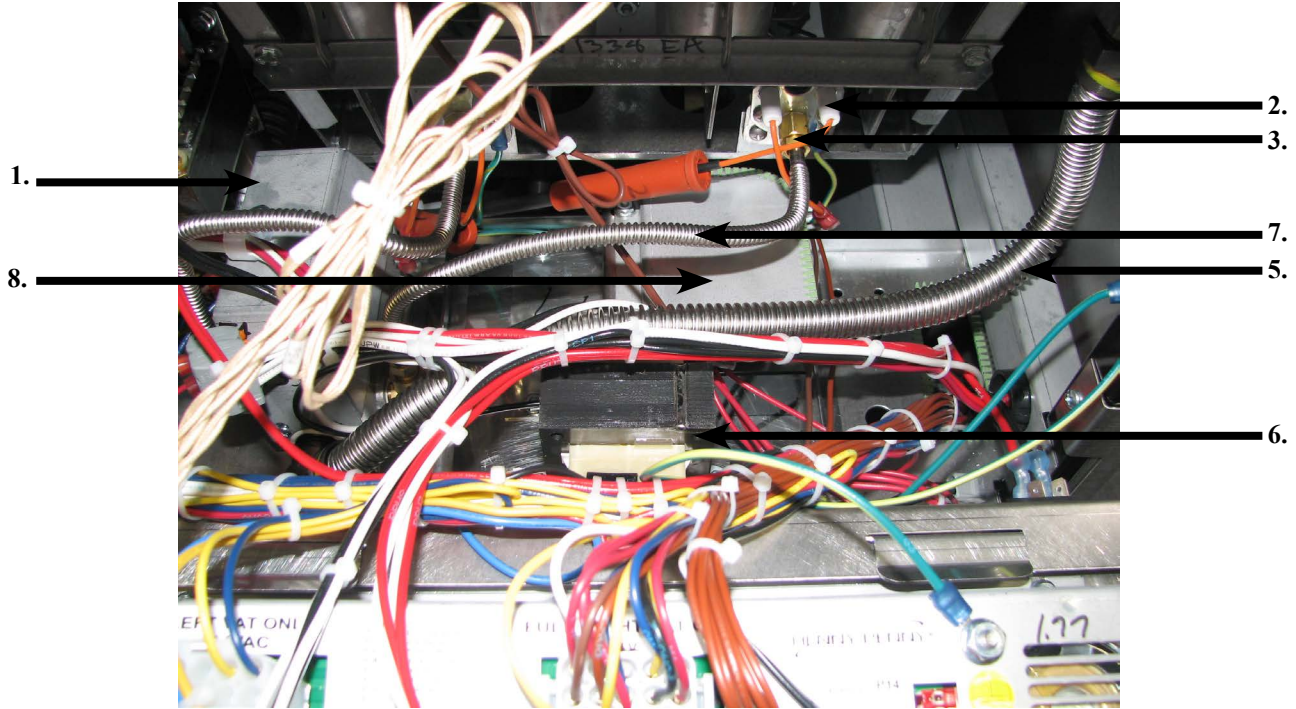

Item No.	Part No.	Description	Quantity
B 1	87648-001	ASSY-GAS VALVE FULL NAT	1/vat
B 1	87663-003	ASSY-GAS VALVE FULL LP	1/vat
2	152899	BURNER-PILOT	1/ 2-well
3		PILOT KIT (See next page for kit numbers)	
3	152747-001	--INLET-FITTING PILOT ORIFICE (NAT)	1/vat
3	152747-002	--INLET-FITTING PILOT ORIFICE (LP)	1//vat
4	76921-001	ORIFICE - BURNER (NAT).....	4/burner
4	76921-002	ORIFICE - BURNER (LP).....	4/burner
5	-----	FLEX TUBE (see flex tube chart for length/part number).....	--
6	84391	ASSY-TRANSFORMER-120V	1/well
7	82491	TUBE-1/4 X 12 FLEX SS PILOT.....	1/ 2-well
8	89624-001	CONTROL-WATLOW HL	1/vat
9*	84987	SWITCH-HL	1/well
10*	76978	SENSOR-FLAME	1/vat

Recommend Parts: A=Truck Stock/B=Dist. Stock / *not shown/ A/R=As Required

Kit Number	Description
140282	KIT-EEG16X OIL TST/BOILOUT PKT
140283	KIT-EEG16X FRYER SUPPLY (Chili's)
140289	KIT-REPL FULL POT ASSY-EEG2XX
140290	KIT-NAT TO LP F UP TO 5000 FT
140291	KIT-LP TO NAT F UP TO 5000 FT
140295	KIT-EEG16X FRYER SPLY-MAGGIANO
140296	KIT-EEG16X/2XX NAT BASO PILOT
140297	KIT-EEG16X/2XX LP BASO PILOT
140307	KIT-EEG16X BULK DISPOSE/FILL

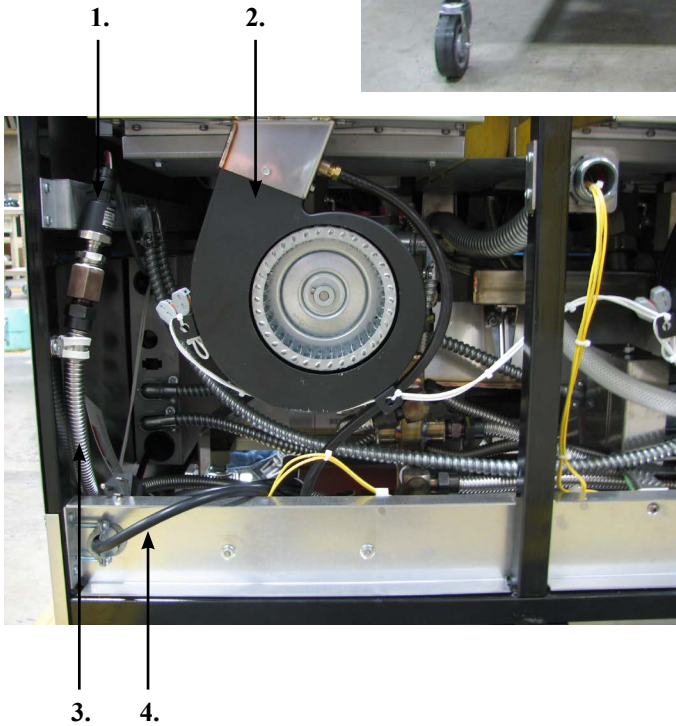

Item No.	Part No.	Description	Quantity
1	79213	TRANSDUCER-PRESSURE 30 PSI.....	1
2	92963-001	BLOWER MOTOR-FLUE EXHAUST 115V	1/well
3	-----	FLEX TUBE (see flex tube chart for length/part number).....	--
4	152902-001	CORD-POWER.....	1
5	151744	VALVE-120V SOLENOID 1/2NPT.....	1/vat
6*	151725	ASSY-POT CHECK VALVE	1/vat
7*	73473	PUMP-OIL TOP OFF 120V.....	1

Recommend Parts: A=Truck Stock/B=Dist. Stock / *not shown/ A/R=As Required

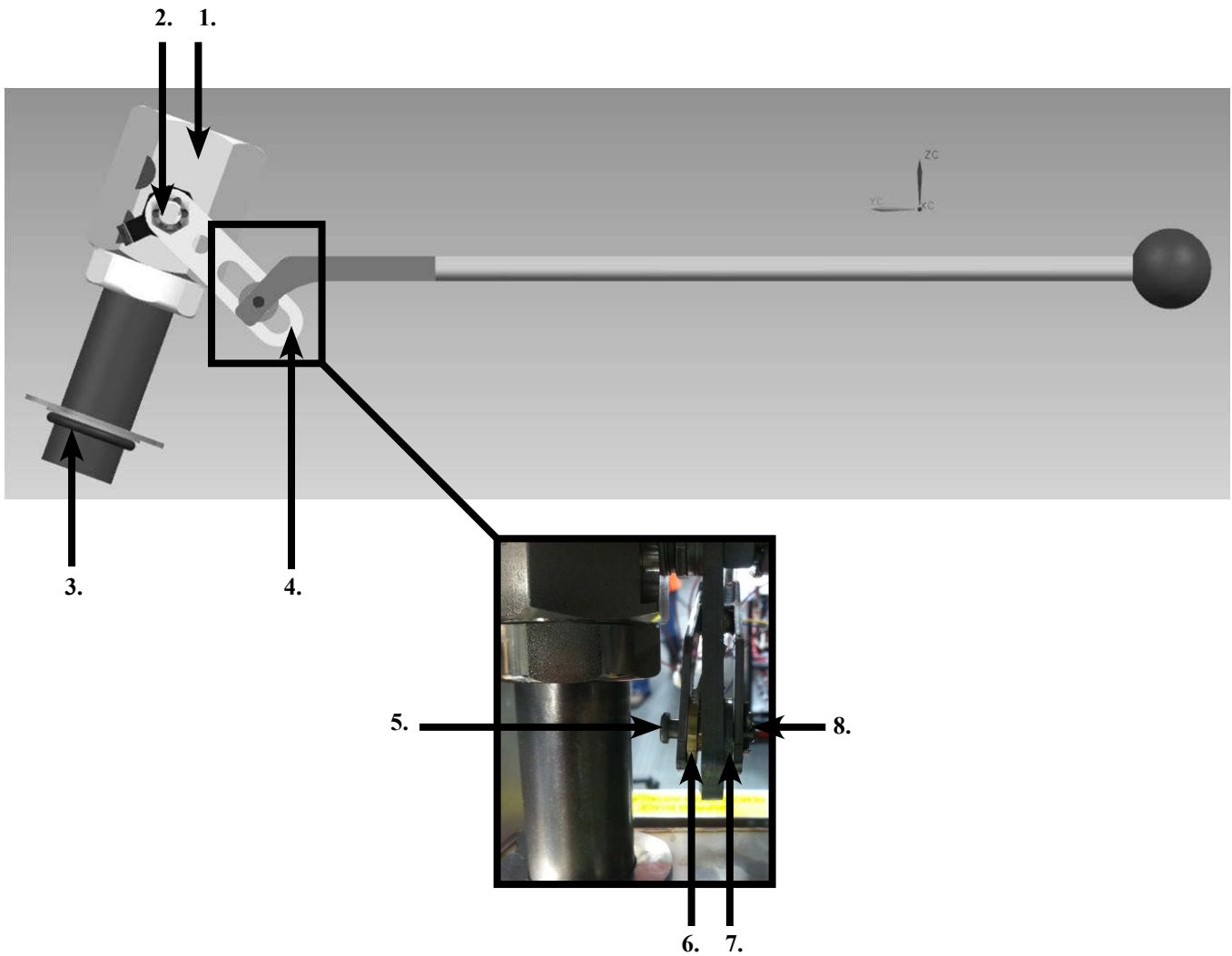

Item No.	Part No.	Description	Quantity
1	151727	VALVE-DRAIN 1 1/2 NPT & CAM LOCK.....	1/vat
2	NS03-103	NUT-CASTLE 1/2-20 18-8 STEEL	1/vat
	17255	--PIN-COTTER.....	1/vat
3	76948	O-RING -325.....	1/vat
4	151106	ARM-PIVOT	1/vat
5	PN01-012	CLEVIS PIN 1/4 X 1 IN. SS	1/vat
6	151156	PIVOT BUSHING ROD LINKAGE	1/vat
7	150181	SPACER-DRAIN ROD LINKAGE	1/vat
8	PN01-039	PIN-COTTER.....	1/vat
9*	50764	MICROSWITCH-RIGID LEVER	1/var

Recommend Parts: A=Truck Stock/B=Dist. Stock / *not shown/ A/R=As Required

FLEX TUBE NUMBERS	
Part Number	Flex Tube Length (in.)
77523-001	12.0
77523-002	18.0
77523-003	24.0
77523-004	30.0
77523-005	36.0
77523-006	42.0
77523-007	48.0
77523-008	7.0
77523-009	13.0
77523-010	54.0
77523-011	10.0
77523-012	13.0
77523-013	14.0
77523-014	28.0
77523-015	32.0
77523-016	16.0

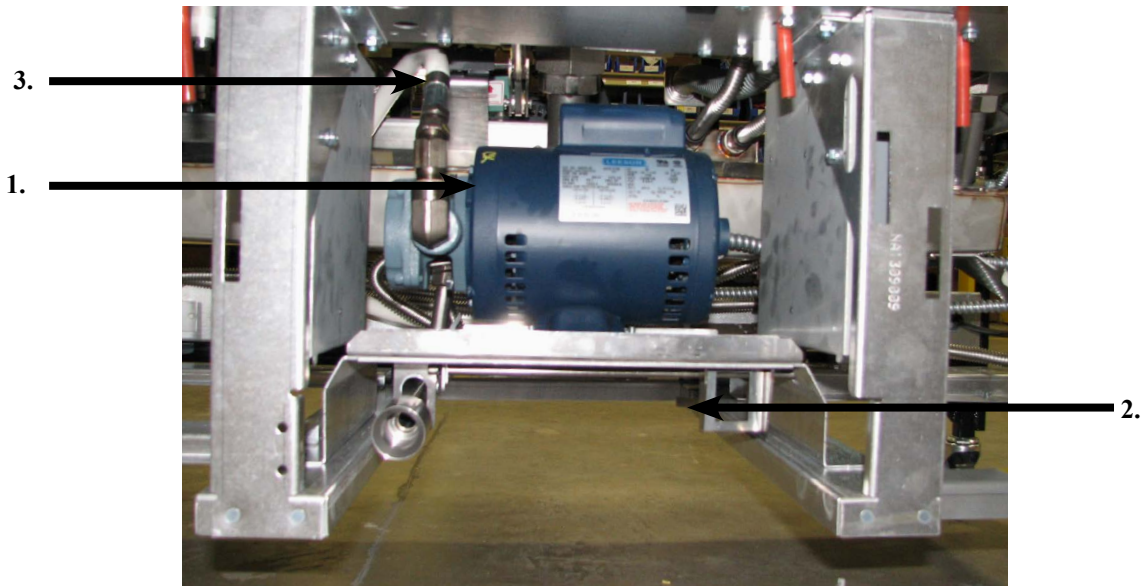

Item No.	Part No.	Description	Quantity
1	151534-001	ASSY-FILTER PUMP MOTOR EEG16X 60HZ.....	1
	67583	--MOTOR-1/2 HP FILTER PUMP.....	1
	17437	--ASSY-SUB PUMP 5 GPM.....	1
	17476	--SEAL KIT.....	1
2	87511	SWITCH-DRAIN PAN.....	1
3	151686-002	HOSE-OIL DISPOSE (34in).....	1
4*	90506-001	VALVE-CHECK SAE 12-3PSI.....	A/R
5*	FP01-256	FTG-12 SAE 1/2 NPT.....	A/R
6*	FP01-283	FTG-12 SAE 8 45 DEG FLARE SWVL.....	A/R

Recommend Parts: A=Truck Stock/B=Dist. Stock / *not shown/ A/R=As Required

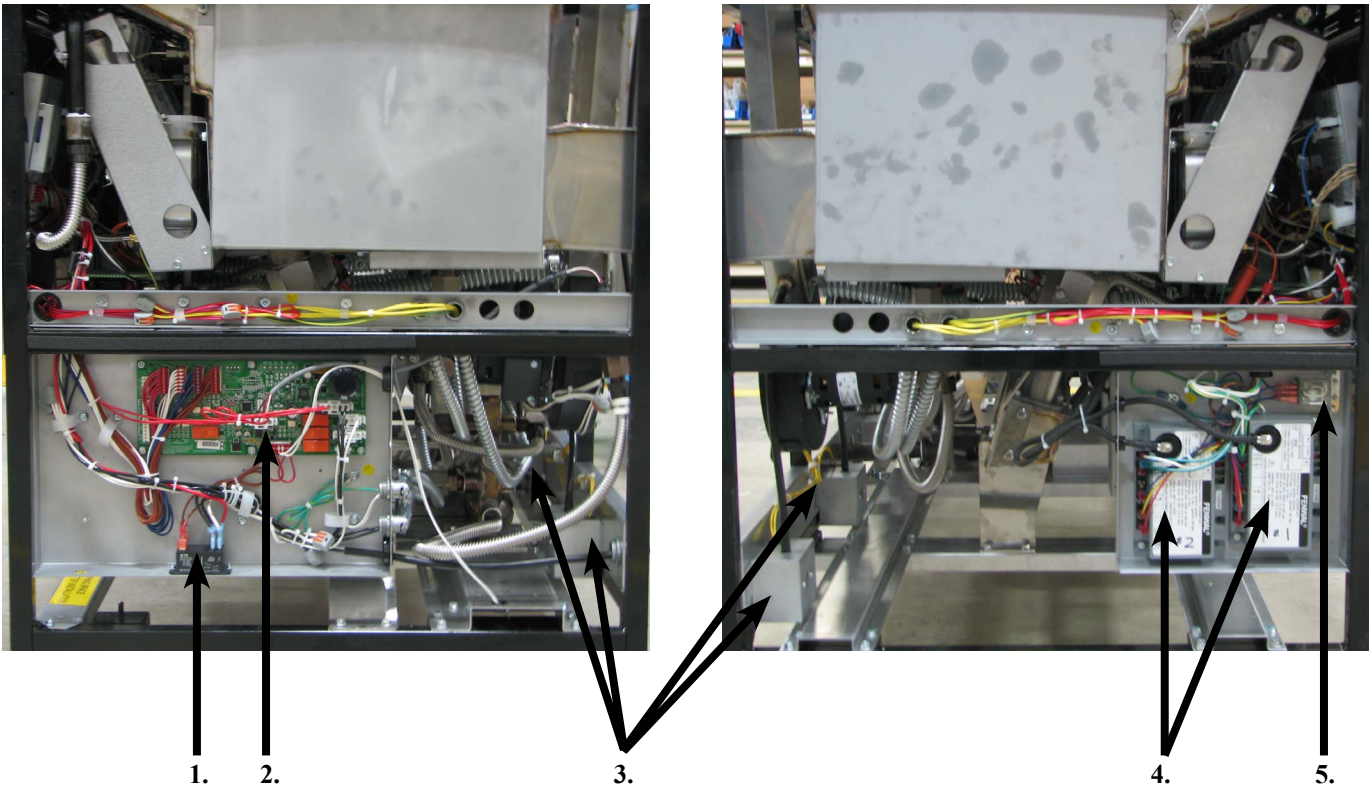

Item No.	Part No.	Description	Quantity
1	ME90-008	P&B T92 RELAY 12VDC COIL 30AMP.....	1
2	84454	ASSY-EVOLUTION ELITE AIF PCB	1
3	77992	SWITCH-PRESSURE 0.80.....	1/vat
4	77839	MODULE-IGNITION NON CE.....	2/well
5	60818	RELAY - 24VAC COIL.....	1/well

Recommend Parts: A=Truck Stock/B=Dist. Stock / *not shown/ A/R=As Required