



Henny Penny

Humidified Holding Cabinets

Model HHC-990

Model HHC-992

Model HHC-993

Model HHC-996

Model HHC-997

Model HHC-998

TECHNICAL MANUAL

LIMITED WARRANTY FOR HENNY PENNY APPLIANCES

Subject to the following conditions, Henny Penny Corporation makes the following limited warranties to the original purchaser only for Henny Penny appliances and replacement parts:

NEW EQUIPMENT: Any part of a new appliance, except lamps and fuses, which proves to be defective in material or workmanship within two (2) years from date of original installation, will be repaired or replaced without charge F.O.B. factory, Eaton, Ohio, or F.O.B. authorized distributor. To validate this warranty, the registration card for the appliance must be mailed to Henny Penny within ten (10) days after installation.

REPLACEMENT PARTS: Any appliance replacement part, except lamps and fuses, which proves to be defective in material or workmanship within ninety (90) days from date of original installation will be repaired or replaced without charge F.O.B. factory, Eaton, Ohio, or F.O.B. authorized distributor.

The warranty for new equipment and replacement parts covers only the repair or replacement of the defective part and does not include any labor charges for the removal and installation of any parts, travel or other expenses incidental to the repair or replacement of a part.

EXTENDED FRYPOT WARRANTY: Henny Penny will replace any frypot that fails due to manufacturing or workmanship issues for a period of up to seven (7) years from date of manufacture. This warranty shall not cover any frypot that fails due to any misuse or abuse, such as heating of the frypot without shortening.

0 TO 3 YEARS: During this time, any frypot that fails due to manufacturing or workmanship issues will be replaced at no charge for parts, labor, or freight. Henny Penny will either install a new frypot at no cost or provide a new or reconditioned replacement fryer at no cost.

3 TO 7 YEARS: During this time, any frypot that fails due to manufacturing or workmanship issues will be replaced at no charge for the frypot only. Any freight charges and labor costs to install the new frypot as well as the cost of any other parts replaced, such as insulation, thermal sensors, high limits, fittings, and hardware, will be the responsibility of the owner.

Any claim must be presented to either Henny Penny or the distributor from whom the appliance was purchased. No allowance will be granted for repairs made by anyone else without Henny Penny's written consent. If damage occurs during shipping, notify the sender at once so that a claim may be filed.

THE ABOVE LIMITED WARRANTY SETS FORTH THE SOLE REMEDY AGAINST HENNY PENNY FOR ANY BREACH OF WARRANTY OR OTHER TERM. BUYER AGREES THAT NO OTHER REMEDY (INCLUDING CLAIMS FOR ANY INCIDENTAL OR CONSEQUENTIAL DAMAGES) SHALL BE AVAILABLE.

The above limited warranty does not apply (a) to damage resulting from accident, alteration, misuse, or abuse; (b) if the equipment's serial number is removed or defaced; or (c) for lamps and fuses. **THE ABOVE LIMITED WARRANTY IS EXPRESSLY IN LIEU OF ALL OTHER WARRANTIES, EXPRESS OR IMPLIED, INCLUDING MERCHANTABILITY AND FITNESS, AND ALL OTHER WARRANTIES ARE EXCLUDED. HENNY PENNY NEITHER ASSUMES NOR AUTHORIZES ANY PERSON TO ASSUME FOR IT ANY OTHER OBLIGATION OR LIABILITY.**

TABLE OF CONTENTS

Section	Page
Section 1. TROUBLESHOOTING	
1-1. Introduction	1-1
1-1. Safety	1-1
1-3. Troubleshooting	1-1
1-4. Error Codes and Warnings	1-5
1-5. Info Mode	1-8
Section 2. LEVEL 2 PROGRAMMING	
2-1. Introduction	2-1
2-2. Tech Mode	2-1
2-3. Stats Mode	2-5
2-4. Data Logging and Manufacturing Mode	2-8
Section 3. MAINTENANCE	
3-1. Introduction	3-1
3-2. Maintenance Hints	3-1
3-3. Humidity Sensor Calibration and Replacement	3-1
3-4. Fuse and Fuse Holder Assembly	3-4
3-5. Power Switch Replacement	3-5
3-6. Air Temperature Probe Replacement	3-6
3-7. Transformer Replacement	3-8
3-8. Food Probe Receptacle Replacement	3-8
3-9. Relay Replacement	3-9
3-10. Module Top Removal	3-10
3-11. Cooling Fan Replacement	3-11
3-12. High Limit - Air Heater Replacement	3-11
3-13. Blower Motor Replacement	3-12
3-14. Air Heater Replacement	3-13
3-15. Speaker Replacement	3-13
3-16. Complete Panel or PC Board Replacement	3-14
3-17. Float Switch Replacement	3-15
3-18. High Limit - Water Heater Replacement	3-16
3-19. Water Heater Replacement	3-17
3-20. Drain Valve Replacement	3-18
3-21. Door Gasket Replacement	3-19
3-22. Vent Motor Replacement	3-19
3-23. Vent Motor Microswitch Replacement	3-20
Wiring Diagrams	3-21
Section 4. PARTS INFORMATION	
4-1. Introduction	4-1
4-2. Genuine Parts	4-1
4-3. When Ordering Parts	4-1
4-4. Prices	4-1
4-5. Delivery	4-1
4-6. Warranty	4-1
4-7. Recommended Spare Parts for Distributors	4-1
Parts List	4-2

SECTION 1. TROUBLESHOOTING

1-1. INTRODUCTION

This section provides troubleshooting information in the form of an easy to read table.

If a problem occurs during the first operation of a cabinet, recheck the installation per the Installation Section of the Operator’s Manual

Before troubleshooting, always recheck the operation procedures in the Operator’s Manual.

1-2. SAFETY

Where information is of particular importance or is safety related, the words NOTICE, CAUTION, or WARNING are used. Their usage is described below.



SAFETY ALERT SYMBOL is used with DANGER, WARNING, or CAUTION which indicates a personal injury type hazard.

NOTICE is used to highlight especially important information.

CAUTION used without the safety alert symbol indicates a potentially hazardous situation which, if not avoided, may result in property damage.

CAUTION used with the safety alert symbol indicates a potentially hazardous situation which, if not avoided, may result in minor or moderate injury.

WARNING indicates a potentially hazardous situation which, if not avoided, could result in death or serious injury.

1-3. TROUBLESHOOTING

To isolate a malfunction, proceed as follows:

1. Clearly define the problem or symptom and when it occurs.
2. Locate the problem in the troubleshooting table.
3. Review all possible causes. Then, one at a time work through the list of corrections until problem is solved.



If maintenance procedures are not followed correctly, injuries and/or property damage could result.

1-3. TROUBLESHOOTING (continued)

Problem	Cause	Correction
OPERATION		
<p>A. Product not holding temperature</p>	<ul style="list-style-type: none"> • Doors left open • Product held too long • Control temperature set too low • Bad air heater • Blower not working • Bad air heater, or blower relays • Bad high limit • Low or improper voltage • Door gasket torn or worn • Air probe faulty, open (“E-6A”), or shorted (“E-6B”) 	<ul style="list-style-type: none"> • Keep doors closed except to load and serve product • Hold product only for recommended times • Increase air temperature setpoint (SP-3) in Special Program Mode • Check heaters and replace if bad See Tech Mode items 10 and 18 • Check blower and replace if bad See Tech Mode item 20 • Replace relay See Tech Mode items 10 and 18 • Check high limit and replace if bad • Compare receptacle voltage to data plate voltage • Replace bad door gaskets • Ohm out the probe and replace if necessary
<p>B. Cabinet steaming or product soggy</p>	<ul style="list-style-type: none"> • Humidity setpoint too high • Water heater probe faulty, open (“E-12A”), or closed (“E-12B”) • Bad humidity sensor (“E17”) • Relay stuck closed • Vent stuck closed (“E-80”) 	<ul style="list-style-type: none"> • Decrease humidity setpoint (SP-4) in Special Program Mode • Ohm out the probe and replace if necessary • Replace humidity sensor • Replace relay • Bad vent motor - replace • Bad vent motor relay - replace- See Tech Mode item 20 • Check alignment and condition of mechanical vent parts

1-3. TROUBLESHOOTING (continued)

Problem	Cause	Correction
OPERATION (Continued)		
C. Product dry	<ul style="list-style-type: none"> • Bad float switch (“E-18”) • Bad water heater high limit • Bad water heater • Humidity setpoint too low • No water in pan • Vent stuck open (“E-80”) 	<ul style="list-style-type: none"> • Replace float switch • Replace high limit • Check heater and replace if bad; see Tech Mode item 20 • Increase humidity setpoint (SP-4) in Special Program Mode • Pour water in water pan • Bad vent motor - replace; see Tech Mode item 20 • Bad vent motor relay - replace • Check alignment and condition of mechanical vent parts
HEATING SYSTEM		
A. Unit not heating	<ul style="list-style-type: none"> • Bad control board • Bad high limit • Bad air heater or blower relays • Bad air heater • Faulty wiring • Blown Fuse 	<ul style="list-style-type: none"> • Replace control board • Check high limit; replace if bad • Replace relay • Check heaters and replace if bad; see Tech Mode item 20 • Check for loose connections or broken wires • Change 15 amp fuse
B. Unit not reaching set temperature	<ul style="list-style-type: none"> • Blower not working. • Bad air heater • Bad air heater, or blower relays • Doors left open • Door gasket torn or worn 	<ul style="list-style-type: none"> • Check Blower and replace if bad; see Tech Mode item 20 • Check heaters and replace if bad; see Tech Mode item 20 • Replace relay • Keep doors closed except to load and serve product • Replace bad door gaskets

1-3. TROUBLESHOOTING (continued)

Problem	Cause	Correction
HEATING SYSTEM (Continued)		
C. Unit Overheating ("E-5")	<ul style="list-style-type: none"> • Blower not working • Bad control board • Relay stuck closed 	<ul style="list-style-type: none"> • Check blower and replace if bad See Tech Mode item 20 • Replace control board • Replace relay

1-4. ERROR CODES AND WARNINGS

The display shows the following error codes and warnings when a fault is detected, along with an alarm sound. Both the heat and humidity systems shut down, except when specified otherwise.

Display	Cause	Panel Board Correction
'E-4 CPU TOO HOT'	<ul style="list-style-type: none"> Control board too hot; unit overheating or louvers clogged 	<ul style="list-style-type: none"> Turn switch to OFF position, then back to ON; if display still shows "E-4", the PC board is getting too hot; clean louvers and check cooling fan; if cooling fan is not working, have it replaced; once panel cools down, the controls should return to normal; if "E-4" persists, have the PC board replaced
'E-5 AIR TEMP TOO HOT'	<ul style="list-style-type: none"> Faulty relay, PC board, or air probe 	<ul style="list-style-type: none"> Turn switch to OFF position, then back to ON; if display shows "E-5", the heating circuits and temperature probe should be checked; once the unit cools down, the controls should return to normal; if "E-5" persists, have the PC board replaced
'E-54A CPU TEMP SENSOR OPEN'	<ul style="list-style-type: none"> Faulty PC board 	<ul style="list-style-type: none"> Turn switch to OFF position, then back to ON; if display shows "E-54A", the control should be re-initialized (see Programming Section); if the error code persists, have PC board replaced
'E-54B CPU TEMP SENSOR SHORTED'	<ul style="list-style-type: none"> Faulty PC board 	<ul style="list-style-type: none"> Turn switch to OFF position, then back to ON; if display shows "E-54B", the control should be re-initialized (see Programming Section); if the error code persists, have PC board replaced
'E-6A AIR TEMP SENSOR FAILED OPEN'	<ul style="list-style-type: none"> Faulty air probe 	<ul style="list-style-type: none"> Turn switch to OFF position, then back to ON; if the display shows "E-6", the temperature probe should be checked; once the temperature probe is repaired, or replaced, the controls should return to normal; if "E-6" persists, have the PC board replaced

1-4. ERROR CODES AND WARNINGS (Continued)

Display	Cause	Panel Board Correction
"E-6B AIR TEMP SENSOR FAILED SHORTED"	<ul style="list-style-type: none"> Faulty air temperature probe 	<ul style="list-style-type: none"> Turn switch to OFF position, then back to ON; if the display shows "E-6", the temperature probe should be checked; once the temperature probe is repaired, or replaced, the controls should return to normal; if "E-6" persists, have PC board replaced
"E-12A WATER HEATER SENSOR FAILED OPEN"	<ul style="list-style-type: none"> Faulty water heater probe 	<ul style="list-style-type: none"> Turn switch to OFF position, then back to ON; if the display shows "E-12A", the water heater should be checked and repaired or replaced (the water heater probe is built into the water heater); the controls should return to normal; if "E-12A" persists, have PC board replaced
"E-12B WATER HEATER SENSOR FAILED CLOSED"	<ul style="list-style-type: none"> Faulty water heater probe 	<ul style="list-style-type: none"> Turn switch to OFF position, then back to ON; if the display shows "E-12B", the water heater should be checked and repaired or replaced (the water heater probe is built into the water heater); the controls should return to normal; if "E-12B" persists, have PC board replaced
"E-17 HUMIDITY SENSOR FAILED"	<ul style="list-style-type: none"> Faulty humidity sensor 	<ul style="list-style-type: none"> Turn switch to OFF position, then back to ON; if the display shows "E-17", the humidity sensor should be checked; once the humidity sensor is repaired, or replaced, the controls should return to normal; if "E-17" persists, have PC board replaced
"E-18 NO WATER, FLOAT SWITCH FAILED"	<ul style="list-style-type: none"> Float switch stuck or faulty; faulty relay (stuck on); water pan needs cleaned; loose or faulty water heater sensor; acorn nuts on water heater cover loose, or water heater insulation missing or damaged 	<ul style="list-style-type: none"> Turn switch to OFF position, then back to ON; if the display shows "E-18", check and clean float switch; clean water pan; have relay and water heater sensor checked and replace if necessary; tighten acorn nuts on water heater cover; make sure 2 complete pieces of insulation are under the water heater cover; if "E-18" persists, have PC board replaced

NOTICE

A humidity error only shuts down the humidity system. If a humidity error occurs, and you want to use the cabinet without humidity, turn the humidity off by following the directions for SP-4, Humidity Setpoint, in Special Programming Section of this manual. Once the setpoint is off, the alarm stops, but the error code shows in display. (Includes "E-12A", "E-12B", "E-17" and "E-18").

1-4. ERROR CODES AND WARNINGS (Continued)

Display	Cause	Panel Board Correction
"E-41 SYSTEM DATA LOST"	<ul style="list-style-type: none"> • Memory scrambled 	<ul style="list-style-type: none"> • Turn switch to OFF position, then back to ON; if the display shows "E-41", the control should be re-initialized (see Programming Section); if "E-41" persists, have PC board replaced
"E-46 DATA SAVE FAILED"	<ul style="list-style-type: none"> • Memory scrambled 	<ul style="list-style-type: none"> • Turn switch to OFF position, then back to ON; if the display shows "E-46", the control should be re-initialized (see Programming Section); if "E-46" persists, have PC board replaced
"E-80 VENT STUCK OR BAD SWITCH"	<ul style="list-style-type: none"> • Vent on rear of module stuck or faulty vent activation switch 	<ul style="list-style-type: none"> • Check vent on rear of module for obstructions, or have vent activation switch replaced
"PLEASE DE-LIME WATER PAN"	<ul style="list-style-type: none"> • Water pan needs cleaned 	<ul style="list-style-type: none"> • Follow the weekly cleaning procedures; this warning will <u>not</u> shut down the heat or humidity; if "PLEASE DE-LIME WATER PAN" persists, have PC board replaced
"WATER LEVEL LOW, PLEASE"	<ul style="list-style-type: none"> • Water pan low on water or empty 	<ul style="list-style-type: none"> • Fill water pan, in bottom of unit, to the maximum water fill mark; this warning <u>won't</u> shut down the heat or humidity

1-5. INFO MODE

This mode records historic information on the holding cabinet and operator performance, which could help in troubleshooting a problem.

This mode records historic information on the unit and operator performance. Press  and  at the same time and

“*INFO MODE*” shows on display. Press  or  to

access the steps and press  to view the statistics within each step.

Information Mode is intended for technical use, but the operator can view the following information:

1. Error Log - last 10 errors and time they occurred
2. Power Up Log - time of last 10 power-ups
3. Outputs/Inputs - shows the state of unit’s inputs and outputs
 - a. OUT V_F_W_A (vent motor, fan, water heater, air heater, relay order from left to right)
 - b. AMPS V_F_W_A_
 - c. NC/GD V_F_W_A_ (no connect/ground detection on outputs to relays)
 - d. All outputs and inputs V_F_W_A_ P_ (power switch input) E_(exhaust vent switch input) F_ (float switch input)
4. Vent - open or closed
5. CPU temperature
6. Cabinet air temperature
7. Water heater temperature
8. Food probe temperature
9. Humidity counts value
10. Humidity value
11. Analog inputs

1-5. INFO MODE (Continued)

1. E-LOG (error code log)

Press  and “1A. (date & time) *NOW*” shows in display.

This is the present date and time.

Press  and if a error was recorded, “1B. (date, time, and error code information)” shows in display. This is the latest error code that the controls recorded.

Press  and the next latest error code information can be seen. Up to 10 error codes (1B to 1K) can be stored in the E-LOG section.

Press  to continue to P-LOG.

2. P-LOG (power-up log)

Press  and “2A. (date & time) *NOW*” shows in display.

This is the present date and time.

Press  and the latest power-up is shown, “2B. (date, time,) PWR-UP”.

Press  and the next latest power-up date is shown. Up to 10 power-ups (2B to 2K) can be stored in the P-LOG section.

Press  to continue onto the Outputs/Inputs.

3. OUTPUTS/INPUTS

This mode displays the status of components and inputs. If the input or output signal is detected, an identifying letter is displayed (see below). If the signal is not detected, “_” is displayed. Press  to view the following:

- a. “V_F_W_A_” shows in the display. If the output is on, “*” shows beside the output letter. Ex: “V*”. If the control senses a problem with the output, “*” flashes.
- b. “AMPS V_F_W_A_” shows in the display. A checkmark (“√”) beside the letter indicates normal amps. A flashing “X” beside the letter means a problem exists.
- c. “NC/GD V_F_W_A_” shows in the display. This monitors a possible problem with the relays on the output PC board. A checkmark (“√”) beside the letter indicates means everything on the output PC board is good. A flashing “X” beside the letter means a problem exists.

1-5. INFO MODE (Continued)

3. OUTPUTS/INPUTS (Continued)

d. V_F_W_A_ P_E_F_ shows in the display. If the output or input signal is detected, "*" shows beside the letter. Ex: "V*". If the control senses a problem with the output, "*" flashes.

Press  to continue onto VENT.

4. VENT

This indicates whether the vent is open or closed.

Press  to continue onto CPU TMP.

5. CPU TMP

This step shows the present PC board temperature.

Press  to continue onto the Cabinet Air TMP.

6. CABINET AIR TMP

This step shows the present air temperature inside the cabinet.

Press  to continue onto the Water Heater TMP.

7. WATER HEATER TMP

This step shows the present water heater temperature.

Press  to continue to Food TMP.

8. FOOD TMP

This step shows the present food probe temperature, if used.

Press  to continue onto Humidity Counts Value.

9. HUMIDITY COUNTS VALUE

Factory use only!

Press  to continue onto the Humidity Value.

10. HUMIDITY VALUE

This step shows the present humidity level inside the cabinet.

Press  to continue onto the Analog Inputs.

1-5. INFO MODE (Continued)

11. ANALOG INPUTS (Continued)

This step displays the present status of any channel of the controller's a-to-d converter. This feature may be useful to a technician troubleshooting a problem with the controller.

The displayed value can be toggled between volts and bits by pressing . If the displayed value has a decimal point, it is

voltage (0 to 5 VDC). If no decimal point is shown, the value is a-to-d bits (0 - 4095).

SECTION 2. LEVEL 2 PROGRAMMING

2-1. INTRODUCTION

The Tech Mode and Stats Mode in the Level 2 Programming, have information that could help in troubleshooting a problem with the unit.

2-2. TECH MODE



Press **PROG** and hold until “L-2 LEVEL 2”, followed by, “CLOCK SET”, shows in display.



Press **PROG** 3 times and “TECH”, followed by, “ENTER CODE” shows in display.

Enter code, 1 1 2 2 1 1 2 2 to access the following items:

- T-1 Software
- T-2 Cabinet version
- T-3 Push button test
- T-4 All on display test
- T-5 Segments test
- T-6 Digits test
- T-7 Decimal points test
- T-8 LED test
- T-9 Air temperature - circuit calibration
- T-10 Air temperature - user calibration/offset/highest value
- T-11 Water heater temperature - circuit calibration
- T-12 Water heater temperature - user calibration/offset/highest value
- T-13 Food temperature - circuit calibration
- T-14 Food temperature - user calibration/offset/highest value
- T-15 Humidity - circuit calibration
- T-16 Humidity sensor – calibration/offset; specific value sent with each humidity sensor
- T-17 Humidity- user calibration/offset/highest value
- T-18 CPU° - control temperature - highest value
- T-19 View ADC channel
- T-20 Outputs/Inputs; on outputs steps use the following hidden buttons [1-4] to toggle on the outputs; [1] - vent motor [2] - circulation fan, [3] - water heater, [4] - air heater
- T-21 Total init – initialization of programming areas and statistics



PROG moves you forward through the above selections and moves you backwards through the selections.



INFO

2-2. TECH MODE (Continued)

T-1: Software

This section shows “PN/ID/SRL”

Press **1**. Henny Penny EPROM part number is displayed.

Press **2**. Customer ID (i.e. Wendy’s) is displayed

Press **3**. Software revision is displayed.

T-2: Cabinet Version

This section shows the model number, e.i. HHC-993.

T3: Push Button Test

Press any button on the control and a digital display feedback confirms the button is working.

T4: All On Display Test

Press any of the product buttons and every LED on the 16 digit display lights.

T5: Segments Test

Repeatedly pressing any product button lights one segments in every one of the 16 digit displays.

T6: Digits Test

Repeatedly pressing any product button lights all segments in one of the 16 digital displays. (Scrolls though all 16.)

T7: Decimal Point Test

Repeatedly pressing any product button lights a decimal point (DP) in one of the 16 digital displays. (Scrolls though all 16.)

T8: LED Test

Repeatedly pressing any product button lights individual LEDs. (Scrolls though all LEDs.)



T9: Air Temperature - Circuit Calibration

Factory use.

2-2. TECH MODE (Continued)

T10: Air Temperature - Calibration/Offset/Highest

This is a user calibration to make sure the display shows the actual air temperature.

Press and hold **1** and use   to set the display to match the actual temperature. (+/-15° F)

Press and hold **2** to change the amount of the offset.(+/-15° F)

Press and hold **3** to view the highest air temperature recorded.



Press  to reset highest temperature.

T11: Water Heater Temperature - Circuit Calibration

Factory use.

T12: Water Heater Temperature - Calibration/Offset/Highest

This is a user calibration to make sure the display shows the actual water heater temperature.

Press and hold **1** and use   to set the display to match the actual temperature. (+/-15° F)

Press and hold **2** to change the amount of the offset.(+/-15° F)

Press and hold **3** to view the highest air temperature recorded.



Press  to reset highest temperature.

T13: Food Probe Temperature - Circuit Calibration

Factory use.

T14: Food Probe Temperature - Calibration/Offset/Highest

This is a user calibration to make sure the display shows the actual food temperature, when using the food probe.

Press and hold **1** and use   to set the display to match the actual temperature. (+/-15° F)

Press and hold **2** to change the amount of the offset.(+/-15° F)

Press and hold **3** to view the highest air temperature recorded.

Press  to reset highest temperature.

2-2. TECH MODE (Continued)

T15: Humidity - Circuit Calibration



See Section 3-3 on Humidity Sensor Calibration and Replacement.

T16: Humidity Sensor - Calibration/Offset

This is a specific value that is sent with the humidity sensor, when necessary. Otherwise, this value should be 0.

T17: Humidity - Calibration/Offset/Highest

This is a user calibration to make sure the display shows the actual humidity inside the cabinet.

Press and hold **1** and use   to set the display to match the actual humidity. (0 to 100%)

Press and hold **2** to change the amount of the offset.(-0 to -99)

Press and hold **3** to view the highest humidity recorded.

Press  to reset highest humidity.

T18: CPU° - Control Temperature - Highest Value

This shows the highest temperature the control board was exposed to.

T19: View ADC Channel

Factory use.

T20: Outputs/Inputs

The following components can be tested:

1 toggles the vent motor off and on.

2 toggles the cooling fan off and on.

3 toggles the water heater off and on.

4 toggles the air heaters off and on.

T21: Total Initialization

This completely resets any accumulated information and changed settings in the controls. Contact Henny Penny before completing this step.



2-3. STATS MODE

Press  and hold until “L-2 LEVEL 2”, followed by, **PROG** “CLOCK SET”, shows in display.

Press  **PROG** 4 times and “STATS”, followed by, “ENTER CODE” shows in display.

Enter code,         to access the following items:

- ST-1 Power live hours
- ST-2 Power ‘on’ hours
- ST-3 Power-ups count
- ST-4 Errors count
- ST-5 Air heat ‘on’ hours
- ST-6 Water heater ‘on’ hours
- ST-7 Circulation fan ‘on’ hours
- ST-8 Water solenoid on hours (no usage for 99X units)
- ST-9 Solenoid cycle count (no usage for 99X units)
- ST-10 Longest solenoid on time; max.=5 minutes (no usage for 99X units)
- ST-11 Vent motor
- ST-12 Highest air temperature
- ST-13 Highest water heater temperature
- ST-14 Highest food temperature
- ST-15 Highest humidity value
- ST-16 Highest CPU temperature
- ST-17 Water heater (too hot) cycle count
- ST-18 Sys ram – fade count
- ST-19 Hold ram – fade count
- ST-20 Stat ram – fade count
- ST-21 Ram data error count
- ST-22 Data total loss count
- ST-23 User init’s count
- ST-24 Auto init’s count
- ST-25 Error log
- ST-26 Power-up log
- ST-27 Heat-up log
- ST-28 Reset all stats

 **PROG** moves you forward through the above selections and  **INFO** moves you backwards through the selections.

2-3. STATS MODE (Continued)

ST-1: Power Live Hours

This section shows the number of hours the control has been on.

ST-2: Power On Hours

This section shows the number of hours the control has been on.

ST-3: Power Ups Count

This section shows the number of times the control has been turned on.

ST-4: Errors Count

This section shows the total number of all errors (displayed on control) that have occurred with the unit.

ST-5: Air Heat On Hours

This section shows the number of hours the air heaters have been on.

ST-6: Water Heater On Hours

This section shows the number of hours the water heater has been on.

ST-7: Circulation Fan On Hours

This section shows the number of hours the cooling fan has been on.

ST-8: Water Solenoid On Hours

Shows the number of hours the solenoid has been on.

ST-9: Solenoid Cycle Count

Shows the number of times the solenoid has been turned on.

ST-10: Longest Solenoid 'On' time. Maximum 5 minutes.

Shows the longest the solenoid has been on at any one time, to a maximum of 5 minutes.

ST-11: Vent Motor On Hours

This section shows the number of hours the vent motor has been on.

ST-12: Highest Air Temperature

This section shows highest air temperature sensed by the temperature probe.

2-3. STATS MODE (Continued)

ST-13: Highest Water Heater Temperature

This section shows the highest water heater temperature, sensed by the water heater temperature sensor.

ST-14: Highest Food Temperature

This section shows the highest food temperature sensed by the food probe.

ST-15: Highest Humidity Value

This section shows the highest humidity value sensed by the humidity sensor.

ST-16: Highest CPU Temperature

This section shows the highest control board temperature sensed by the control.

ST-17: Water heater (too hot) cycle count

Shows the number of times the water heater has gotten too hot

ST-18: System Ram - Fade Count

This section shows the number of times the system memory has been lost during power up. Ex: °F or °C, or speaker volume.

ST-19: Hold Ram - Fade Count

This section shows the number of times the hold memory has been lost during a power up. May be lost at a power up, after a power loss, during a holding cycle.

ST-20: Stat Ram - Fade Count

This section shows the number of times the stats memory has been lost during power up. The information in the Stats Mode is updated every two hours, and this count lets you know that the updates were lost.

ST-21: Ram Data Error Count

This section shows the number of times the data was lost while operating, not during power up. (Should be a low number.)

ST-22: Data Total Loss Count

This section shows the number of times the data stored in the Eprom has been lost. Should see an "E-41" error code when this occurs.

ST-23: User Init's Count



This section shows the number of times the operator has initialized the controls.

2-3. STATS MODE (Continued)

ST-24: Auto Init's Count



This section shows the number of times the controls have initialized itself.

ST-25: Error Log

This section records the last 10 errors and the time they occurred. Press   to view the log.





ST-26: Power Up Log

This section records the last 10 power ups and when they occurred. Press   to view the log.



ST-27: Heat Up Log

This section records the last 10 heat ups between 250° F (121° C) to 300° F (149° C), when they occurred, and how long (seconds) it took. Press   to view the log.



ST-28: Resets All Stats

This section allows the user to reset all data stored in the Stats Mode. Press and hold  for 3 seconds.



2-4. DATA LOGGING AND MANUFACTURING MODE

The Data Logging and Manufacturing Mode are mainly for Henny Penny use only. For more information on these modes, contact the Service Department at 1-800-417- 8405, or 1-937-456-8405.

SECTION 3. MAINTENANCE

3-1. INTRODUCTION

This section provides procedures for the checkout and replacement of the various parts used within the merchandiser. Before replacing any parts, refer to the Troubleshooting Section. It will aid you in determining the cause of the malfunction.

3-2. MAINTENANCE HINTS

1. You may want to use a multimeter to check the electric components.
2. When the manual refers to the circuit being closed, the multimeter should read zero unless otherwise noted.
3. When the manual refers to the circuit being open, the multimeter reads infinity.

3-3. HUMIDITY SENSOR CALIBRATION AND REPLACEMENT

The humidity sensor relays the cabinet humidity to the controls. If it becomes faulty, “E-17”, then “HUMIDITY SENSOR FAILED” shows on the display. Replace sensor as follows:

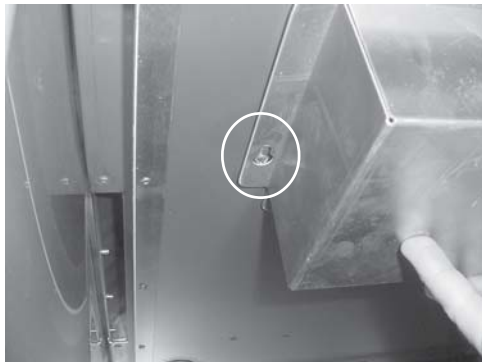

Figure 3-1



To avoid electrical shock or property damage, move the POWER switch to OFF and disconnect main circuit breaker, or unplug cord at wall receptacle.

Replacement:

1. Open top, operator side door of full-size units, or operator door of 1/2 size units.
2. Using a Phillip’s head screwdriver, remove the front screw and loosen the 2 side screws securing the sensor cover. Slide cover towards you and over loosened screws.
Figure 3-1
3. Using a Phillip’s head screwdriver, remove the 4 screws securing the sensor to the box. Figure 3-2.

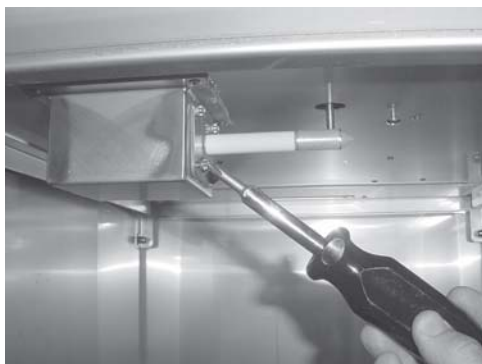

Figure 3-2

**3-3. HUMIDITY SENSOR
CALIBRATION AND
REPLACEMENT
(Continued)**

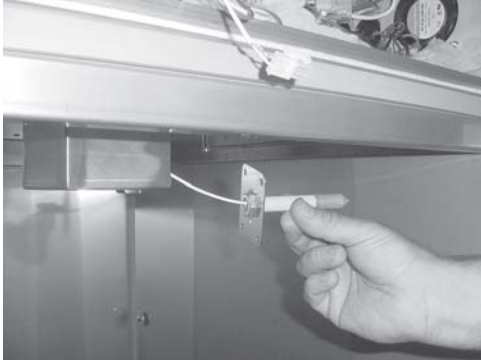

Figure 3-3

4. Pull the sensor assembly from the box and disconnect the wires. Figure 3-3.
5. Connect wires of new sensor and attach the sensor to the box. Follow the calibration instructions below before re-attaching the sensor cover.
6. Once the calibration is complete, slide the cover over the Phillip's head screws and tighten. Unit is now ready for use.

Calibration:

Calibrate the humidity sensor after a sensor or control replacement. A calibration board is supplied with each control kit and humidity sensor kit, but can also be ordered separately with part number, 14391.

1. If not already done, open the cabinet door, and remove the humidity sensor cover at top of unit. (See step 2, page 3-1.)
2. While holding the white tube, unscrew the silver cap from the humidity sensor.
3. Remove the two pronged sensor by grasping the edges. Figure 3-4.

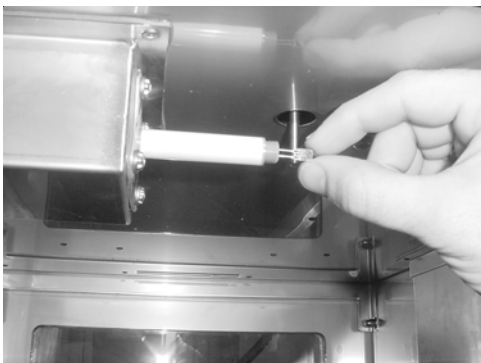



Figure 3-4

NOTICE

Use caution not to touch the flat edge, as it will throw the reading off.

4. Push and hold  until "Level 2" appears in display.
PROG
5. Press  to step through the menu until "TECH" is displayed.
PROG

**3-3. HUMIDITY SENSOR
CALIBRATION AND
REPLACEMENT
(Continued)**

- Using the timer buttons, (Figure 3-5), enter code of 11221122.



Figure 3-5



Figure 3-6

- Press **PROG** to step through menu to step 15.
- Insert the two prongs of the calibration board marked 20% into the humidity sensor. Figure 3-6.
- Press and hold **1**, then press **DOWN**. Release both buttons. 20% should then show in display.
- Reverse calibration board and insert the two prongs marked 80% into humidity sensor.
- Push and hold **2** then press **DOWN**. Release both buttons. 80% should then show in display.
- Push **PROG** to step 16.
- Find the offset number on the mounting plate of the humidity sensor.

NOTICE

When changing the control board on units with serial number IV178JB and below, no offset will be found. Leave offset at 0.

- Push and hold **2**, then press **DOWN** **UP** to enter the offset number.
- Press and hold **PROG** to exit Tech Mode.
- Reinstall two pronged sensor into humidity sensor.
- Reinstall silver cap and sensor cover, and unit is now ready for use.

3-4. FUSE AND FUSE HOLDER ASSEMBLY

If the unit (non-CE) is completely inoperative, but power exists at the wall receptacle, check the 15 amp fuse(s) and fuse holder(s) as follows:



To avoid electrical shock or property damage, move the POWER switch to OFF and disconnect main circuit breaker, or unplug cord at wall receptacle.

Checking Fuse(s)

1. Unscrew the fuse holder cap by turning it counterclockwise. (Located under the power cord.) Figure 3-7.
2. Pull the fuse from the cap and check for continuity by placing the leads of a multimeter or continuity light on opposite ends of the fuse. The fuse should show closed or read no resistance. If fuse is defective, replace it with a new one. Be sure replacement fuse is identical to the one being replaced. (208 or 240 volt units have 2 fuses and both should be checked.)



Figure 3-7

Checking Fuse Holder(s)

If fuses show good, the fuse holders may be bad. Check the fuse holders as follows:



To avoid electrical shock or property damage, move the POWER switch to OFF and disconnect main circuit breaker, or unplug cord at wall receptacle.

1. Remove the screws securing the rear access panel and pull panel down.
2. Remove the wires from the fuse holder, and check for continuity by placing the leads of a multimeter or continuity light on terminals of the fuse holder. The fuse holder should show closed or read no resistance. Figure 3-8.
3. If fuse holder shows it's defective, remove the screws securing it to the panel and replace it with a new one. Figure 3-9.
4. Reinstall the rear panel and make sure the fuse holder has a 15 amp fuse in it.
5. Restore power to the cabinet and it's now ready for use.



Figure 3-8



Figure 3-9

3-5. POWER SWITCH REPLACEMENT



To avoid electrical shock or property damage, move the POWER switch to OFF and disconnect main circuit breaker, or unplug cord at wall receptacle.

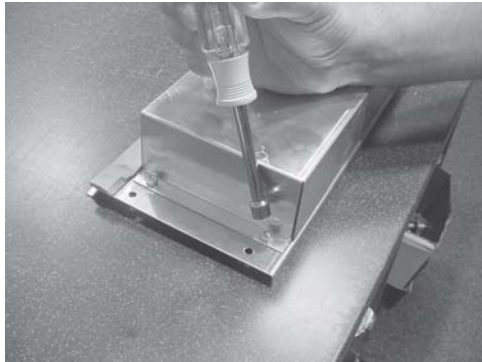

Figure 3-10

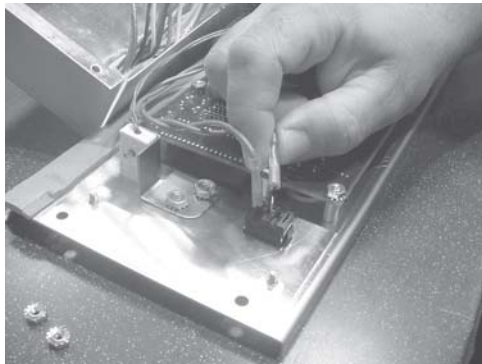

Figure 3-11

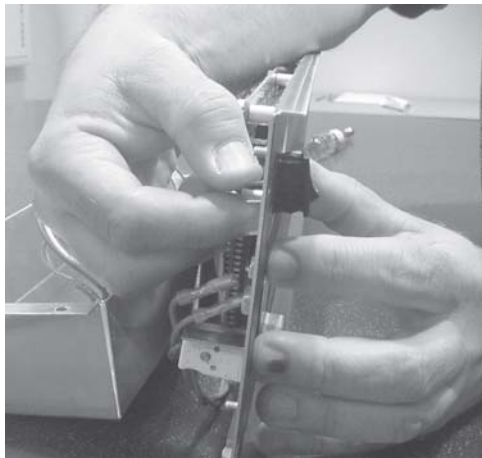

Figure 3-12

1. Using a Phillip's head screwdriver, remove the four screws securing the front panel.
2. Pull panel down, pull connectors from the back of it, and remove panel from unit.
3. Using 5/16" socket, remove the 4 nuts securing the control cover and remove cover. Figure 3-10.
4. Pull wires from switch and check across the 2 terminals for continuity. Figure 3-11. With switch in ON position, the circuit should be closed. In the OFF position, the circuit should be open. If the switch is defective, continue with step 5.
5. Pinch the tabs on the rear of the switch and pull the switch through the front of the panel. Figure 3-12.
6. Replace with new switch in reverse order and unit is now ready for use.

3-6. AIR TEMPERATURE PROBE REPLACEMENT



To avoid electrical shock or property damage, move the **POWER** switch to **OFF** and disconnect main circuit breaker, or unplug cord at wall receptacle.

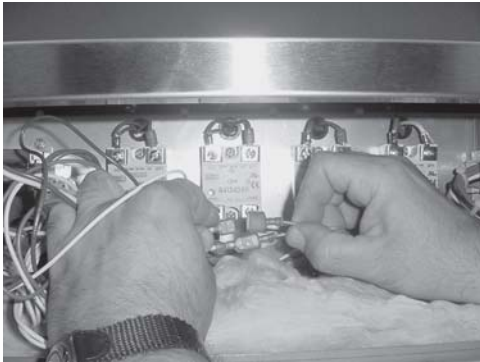

Figure 3-13

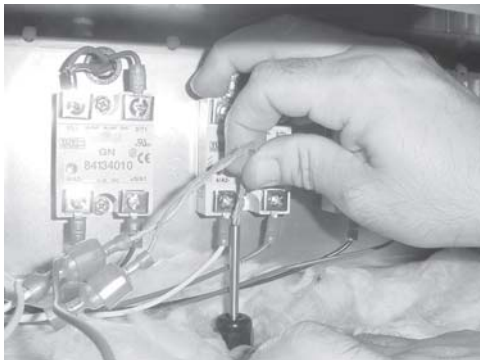

Figure 3-14



Figure 3-15

1. Using a Phillip's head screwdriver, remove the four screws securing the front panel.
2. Pull panel down, pull connectors from the back of it, and remove panel from unit.
3. Unplug the wires to the probe. Figure 3-13.
4. Using a multimeter, or ohmmeter, check across the probe terminals for the correct ohms using the RTD Resistance Chart on the following page. If the probe proves faulty, continue onto step 5.
5. Using a 3/4" wrench, loosen probe strain relief and pull the probe from the unit. Figure 3-14.
6. Slide new probe through the strain relief, extending the probe about 1" (25.4 mm) into the cabinet area. Figure 3-15.
7. Plug probe wires to the unit, tighten the strain relief, and replace front panel. Unit is now ready for use.

RTD Resistance Chart

Temp. F	Temp. C	Resistance		Temp. F	Temp. C	Resistance		Temp. F	Temp. C	Resistance		Temp. F	Temp. C	Resistance	
		Ohms	Ohms			Ohms	Ohms			Ohms	Ohms			Ohms	Ohms
32	0.00	1000.00	1095.18	120	77	48.89	1189.67	164	73.33	1283.47	1376.57	208	97.78	1376.57	1471.66
33	0.56	1002.17	1097.33	121	49.44	1191.81	1191.81	165	73.89	1285.59	1378.68	209	98.33	1378.68	1473.77
34	1.11	1004.34	1099.49	122	50.00	1193.95	1193.95	166	74.44	1287.71	1380.79	210	98.89	1380.79	1475.87
35	1.67	1006.51	1101.64	123	50.56	1196.09	1196.09	167	75.00	1289.84	1382.89	211	99.44	1382.89	1477.97
36	2.22	1008.68	1103.80	124	51.11	1198.23	1198.23	168	75.56	1291.96	1385.00	212	100.00	1385.00	1480.07
37	2.78	1010.85	1105.95	125	51.67	1200.36	1200.36	169	76.11	1294.08	1387.11	213	100.56	1387.11	1482.17
38	3.33	1013.02	1108.10	126	52.22	1202.50	1202.50	170	76.67	1296.20	1389.21	214	101.11	1389.21	1484.27
39	3.89	1015.18	1110.26	127	52.78	1204.64	1204.64	171	77.22	1298.32	1391.32	215	101.67	1391.32	1486.37
40	4.44	1017.35	1112.41	128	53.33	1206.78	1206.78	172	77.78	1300.45	1393.42	216	102.22	1393.42	1488.47
41	5.00	1019.52	1114.56	129	53.89	1208.91	1208.91	173	78.33	1302.57	1395.53	217	102.78	1395.53	1490.57
42	5.56	1021.69	1116.72	130	54.44	1211.05	1211.05	174	78.89	1304.69	1397.63	218	103.33	1397.63	1492.67
43	6.11	1023.86	1118.87	131	55.00	1213.18	1213.18	175	79.44	1306.81	1399.74	219	103.89	1399.74	1494.77
44	6.67	1026.02	1121.02	132	55.56	1215.32	1215.32	176	80.00	1308.93	1401.84	220	104.44	1401.84	1496.87
45	7.22	1028.19	1123.17	133	56.11	1217.45	1217.45	177	80.56	1311.05	1403.95	221	105.00	1403.95	1498.97
46	7.78	1030.36	1125.32	134	56.67	1219.59	1219.59	178	81.11	1313.17	1406.05	222	105.56	1406.05	1501.07
47	8.33	1032.52	1127.47	135	57.22	1221.72	1221.72	179	81.67	1315.28	1408.15	223	106.11	1408.15	1503.17
48	8.89	1034.69	1129.62	136	57.78	1223.86	1223.86	180	82.22	1317.40	1410.25	224	106.67	1410.25	1505.27
49	9.44	1036.85	1131.77	137	58.33	1225.99	1225.99	181	82.78	1319.52	1412.36	225	107.22	1412.36	1507.37
50	10.00	1039.02	1133.92	138	58.89	1228.12	1228.12	182	83.33	1321.64	1414.46	226	107.78	1414.46	1509.47
51	10.56	1041.18	1136.07	139	59.44	1230.26	1230.26	183	83.89	1323.76	1416.56	227	108.33	1416.56	1511.57
52	11.11	1043.35	1138.22	140	60.00	1232.39	1232.39	184	84.44	1325.87	1418.66	228	108.89	1418.66	1513.67
53	11.67	1045.51	1140.36	141	60.56	1234.52	1234.52	185	85.00	1327.99	1420.76	229	109.44	1420.76	1515.77
54	12.22	1047.67	1142.51	142	61.11	1236.65	1236.65	186	85.56	1330.10	1422.86	230	110.00	1422.86	1517.87
55	12.78	1049.84	1144.66	143	61.67	1238.79	1238.79	187	86.11	1332.22	1424.96	231	110.56	1424.96	1519.97
56	13.33	1052.00	1146.81	144	62.22	1240.92	1240.92	188	86.67	1334.34	1427.06	232	111.11	1427.06	1522.07
57	13.89	1054.16	1148.95	145	62.78	1243.05	1243.05	189	87.22	1336.45	1429.16	233	111.67	1429.16	1524.17
58	14.44	1056.32	1151.10	146	63.33	1245.18	1245.18	190	87.78	1338.57	1431.26	234	112.22	1431.26	1526.27
59	15.00	1058.49	1153.24	147	63.89	1247.31	1247.31	191	88.33	1340.68	1433.36	235	112.78	1433.36	1528.37
60	15.56	1060.65	1155.39	148	64.44	1249.44	1249.44	192	88.89	1342.79	1435.46	236	113.33	1435.46	1530.47
61	16.11	1062.81	1157.53	149	65.00	1251.57	1251.57	193	89.44	1344.91	1437.55	237	113.89	1437.55	1532.57
62	16.67	1064.97	1159.68	150	65.56	1253.70	1253.70	194	90.00	1347.02	1439.65	238	114.44	1439.65	1534.67
63	17.22	1067.13	1161.82	151	66.11	1255.83	1255.83	195	90.56	1349.13	1441.75	239	115.00	1441.75	1536.77
64	17.78	1069.29	1163.97	152	66.67	1257.95	1257.95	196	91.11	1351.25	1443.85	240	115.56	1443.85	1538.87
65	18.33	1071.45	1166.11	153	67.22	1260.08	1260.08	197	91.67	1353.36	1445.94	241	116.11	1445.94	1540.97
66	18.89	1073.61	1168.26	154	67.78	1262.21	1262.21	198	92.22	1355.47	1448.04	242	116.67	1448.04	1543.07
67	19.44	1075.77	1170.40	155	68.33	1264.34	1264.34	199	92.78	1357.58	1450.13	243	117.22	1450.13	1545.17
68	20.00	1077.92	1172.54	156	68.89	1266.46	1266.46	200	93.33	1359.69	1452.23	244	117.78	1452.23	1547.27
69	20.56	1080.08	1174.68	157	69.44	1268.59	1268.59	201	93.89	1361.80	1454.32	245	118.33	1454.32	1549.37
70	21.11	1082.24	1176.83	158	70.00	1270.72	1270.72	202	94.44	1363.91	1456.42	246	118.89	1456.42	1551.47
71	21.67	1084.40	1178.97	159	70.56	1272.84	1272.84	203	95.00	1366.02	1458.51	247	119.44	1458.51	1553.57
72	22.22	1086.55	1181.11	160	71.11	1274.97	1274.97	204	95.56	1368.13	1460.61	248	120.00	1460.61	1555.67
73	22.78	1088.71	1183.25	161	71.67	1277.09	1277.09	205	96.11	1370.24	1462.70	249	120.56	1462.70	1557.77
74	23.33	1090.87	1185.39	162	72.22	1279.22	1279.22	206	96.67	1372.35	1464.79	250	121.11	1464.79	1559.87
75	23.89	1093.02	1187.53	163	72.78	1281.34	1281.34	207	97.22	1374.46	1466.89	251	121.67	1466.89	1561.97

3-7. TRANSFORMER REPLACEMENT

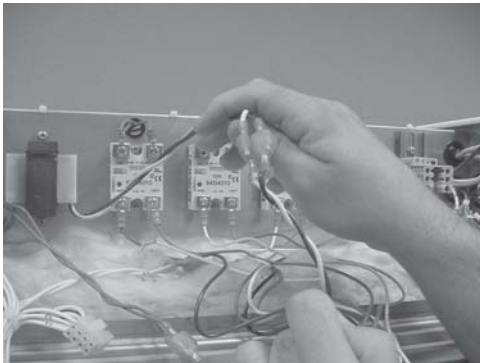

Figure 3-16



Figure 3-17

3-8. FOOD PROBE RECEPTACLE REPLACEMENT



Figure 3-18



To avoid electrical shock or property damage, move the **POWER** switch to **OFF** and disconnect main circuit breaker, or unplug cord at wall receptacle.

1. Using a Phillip's head screwdriver, remove the four screws securing the front panel.
2. Pull panel down, pull connectors from the back of it, and remove panel from unit.
3. Label wires to transformer and unplug wires to transformer. Figure 3-16.
4. Using a Phillip's head screwdriver, remove the 2 screws securing the transformer and pull transformer from unit. Figure 3-17.
5. Install new transformer in reverse order and unit is now ready for use.



To avoid electrical shock or property damage, move the **POWER** switch to **OFF** and disconnect main circuit breaker, or unplug cord at wall receptacle.

1. Using a Phillip's head screwdriver, remove the four screws securing the front panel.
2. Pull panel down, pull connectors from the back of it, and remove panel from unit.
3. Using 5/16" socket, remove the 4 nuts securing the control cover and remove cover.
4. Using a 3/8" socket, remove the nuts securing the receptacle bracket, and pull bracket from control panel.
5. Pull connector from the PC board. Figure 3-18.
5. Install new receptacle assembly in reverse order.

3-9. RELAY REPLACEMENT



To avoid electrical shock or property damage, move the POWER switch to OFF and disconnect main circuit breaker, or unplug cord at wall receptacle.

Checkout:

1. Using a Phillip's head screwdriver, remove the four screws securing the front panel.
2. Pull panel down, pull connectors from the back of it, and remove panel from unit.



The following checks are performed with the wall circuit breaker closed and the main power switch in the ON position. Extreme caution should be taken. Make connections before applying power, take reading, and remove power before removing meter leads, or electrical shock could result.

3. With power reappplied, let unit start heating up, or enter the Tech Mode in Special Program Mode and check the relays in the output test. (See T-18 in the Tech Mode Section)
4. With the component energized (example: air heaters), 0 volts should show on the output side of the relay, and 12 volts on the input side.
5. With the component not energized, 208 or 240 volts should show on the output side of relay, and 0 volts on input.
6. If voltage varies from steps 4 and 5, remove power to unit, pull input wires from relay and place leads of meter onto input wires. Reapply power to unit. When unit is running, the input wires to relay should show 12 vdc volts. If this proves true, the relay is faulty and continue onto step 7.

3-9. RELAY REPLACEMENT **(Continued)**



Figure 3-19

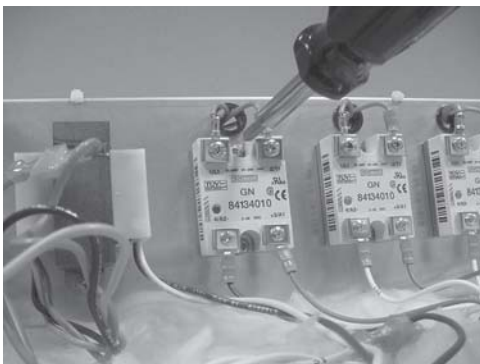

Figure 3-20

3-10. MODULE TOP **REMOVAL**



Figure 3-21



Figure 3-22

7. Label wires and then remove wires from relay using a Phillip's head screwdriver. Figure 3-19.
8. Using a Phillip's head screwdriver, remove the 2 screws securing the relay and remove relay from unit. Figure 3-20.
9. Coat the back of the relay with the thermal joint compound.

CAUTION

Failure to use the thermal joint compound will shorten the life of the relay.

10. Install new relay in reverse order and unit is now ready for use.



To avoid electrical shock or property damage, move the POWER switch to OFF and disconnect main circuit breaker, or unplug cord at wall receptacle.

1. Using a Phillip's head screwdriver, remove the module screws from the side. Figure 3-21.
2. Remove screws from front and rear panels.
3. Pull module top from module. Figure 3-22.

3-11. COOLING FAN REPLACEMENT

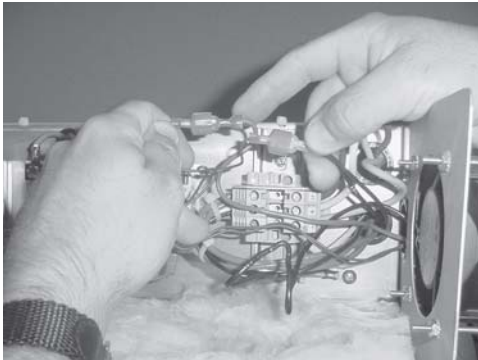

Figure 3-23

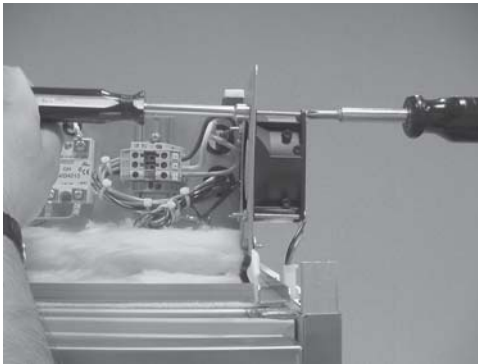

Figure 3-24

3-12. HIGH LIMIT-AIR HEATER REPLACEMENT

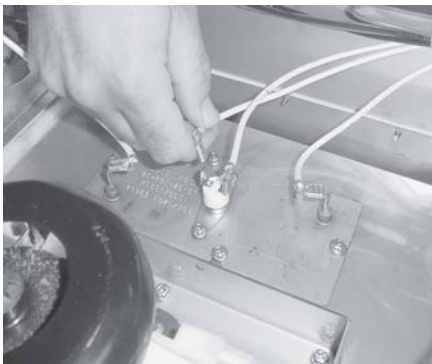

Figure 3-25



Figure 3-26



To avoid electrical shock or property damage, move the **POWER** switch to **OFF** and disconnect main circuit breaker, or unplug cord at wall receptacle.

1. Refer to section 3-10 for module top removal.
2. Unplug connectors to the cooling fan. Figure 3-23.
3. Remove screws and nuts securing the fan and remove fan from module. Figure 3-24.
4. Install new fan in reverse order and unit is now ready for use.



To avoid electrical shock or property damage, move the **POWER** switch to **OFF** and disconnect main circuit breaker, or unplug cord at wall receptacle.

1. Follow the instructions in section 3-10 on removing the module top.
2. Remove wires from high limit. Figure 3-25.
3. Check across the terminals for continuity. If the unit is not heating, the circuit should be closed, or read no resistance. If high limit is defective, continue onto step 4.
4. Remove the 2 screws securing the high limit and remove high limit. Figure 3-26.
5. Install new high limit in reverse order and unit is now ready for use.

3-13. BLOWER MOTOR REPLACEMENT



To avoid electrical shock or property damage, move the POWER switch to OFF and disconnect main circuit breaker, or unplug cord at wall receptacle.

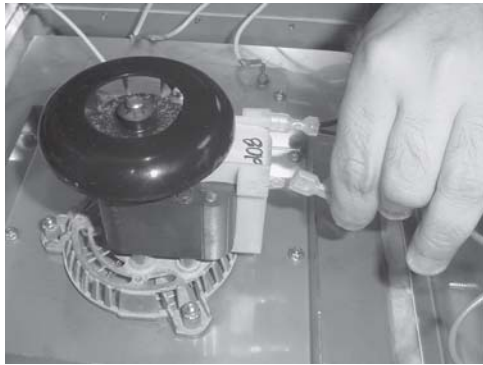

Figure 3-27



Figure 3-28



Figure 3-29

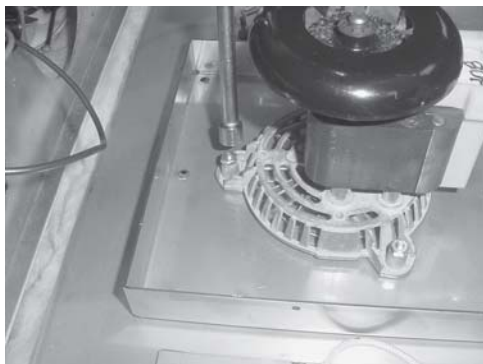

Figure 3-30

1. Follow the instructions in section 3-10 on removing the module top.
2. Unplug wires to blower motor. Figure 3-27.
3. Using a Phillip's head screwdriver, remove the screws securing the blower bracket to the module. Figure 3-28.
4. Pull bracket from module. Loosen set screw on fan blade and pull blade from blower. Figure 3-29.
5. Remove the 3 nuts securing the blower to the bracket and remove blower motor. Figure 3-30.
6. Install new blower in reverse order, and unit is now ready for use.

3-14. AIR HEATER REPLACEMENT

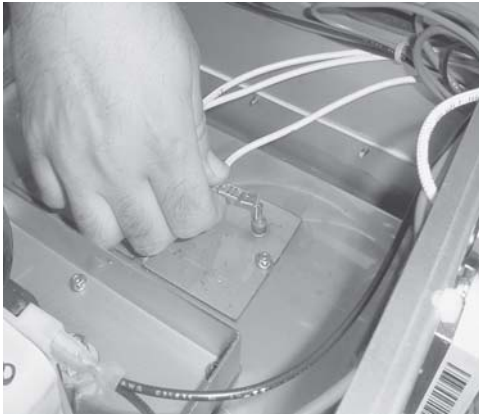

Figure 3-31

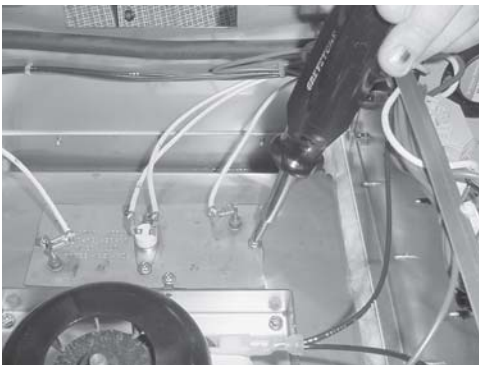

Figure 3-32

3-15. SPEAKER REPLACEMENT



Figure 3-33

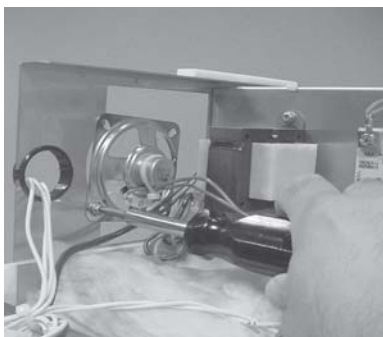

Figure 3-34



To avoid electrical shock or property damage, move the POWER switch to OFF and disconnect main circuit breaker, or unplug cord at wall receptacle.

1. Follow the instructions in Module Top Removal Section on removing the module top.
2. Unplug the wires to the heater and high limit. Figure 3-31.
3. Using a Phillip's head screwdriver, remove the 4 screws securing the heater and remove heater. Figure 3-32.
4. Install new heater in reverse order and unit is now ready for use.



To avoid electrical shock or property damage, move the POWER switch to OFF and disconnect main circuit breaker, or unplug cord at wall receptacle.

1. Remove the 4 screws securing the front panel.
2. Pull connectors from back of panel and remove panel.
3. Unplug wires to speaker. Figure 3-33.
4. Using a Phillip's head screwdriver, remove the screws securing the speaker and remove speaker. Figure 3-34.
5. Install new speaker in reverse order and unit is now ready for use.

3-16. COMPLETE PANEL OR PC BOARD REPLACEMENT

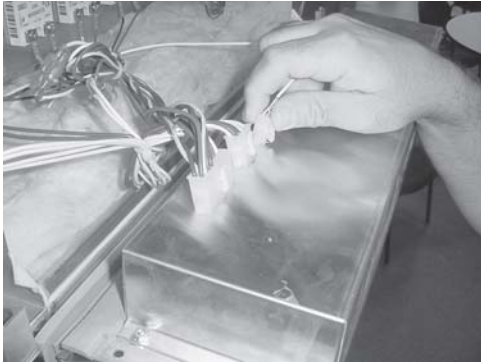

Figure 3-35

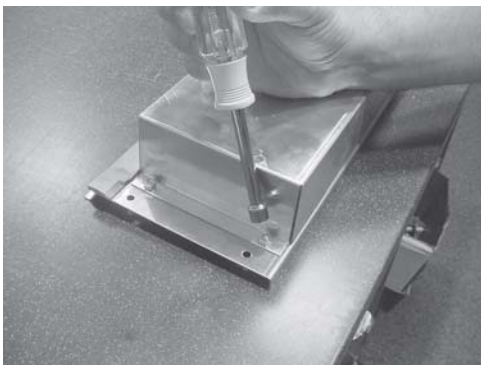

Figure 3-36

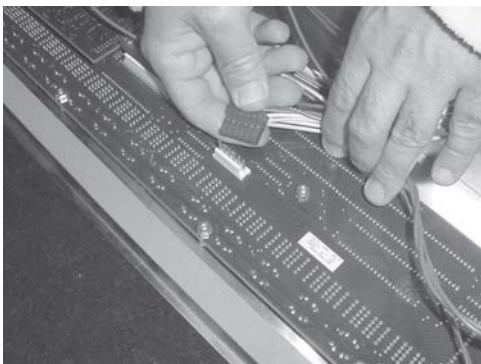

Figure 3-37

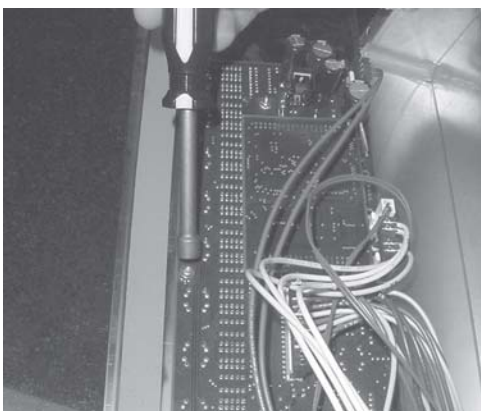

Figure 3-38



To avoid electrical shock or property damage, move the POWER switch to OFF and disconnect main circuit breaker, or unplug cord at wall receptacle.

The complete control panel assembly can be replaced, or just the PC board. Follow steps 1 & 2 for the complete panel and continue with the remaining steps for the PC Board replacement.

1. Remove the 4 screws securing the front panel.
2. Pull connectors from back of panel and remove panel. Figure 3-35. Install complete panel in reverse order. When installing the PC board, continue to step 3.
3. Using 5/16" socket, remove the 4 nuts securing the control cover and remove cover. Figure 3-36.
4. Pull the connectors from PC Board. Figure 3-37.
5. Using 5/16" socket, remove the 8 nuts securing the PC board and remove board. Figure 3-38.
6. Install new PC board in reverse order and unit is now ready for use.

3-17. FLOAT SWITCH REPLACEMENT



Figure 3-39

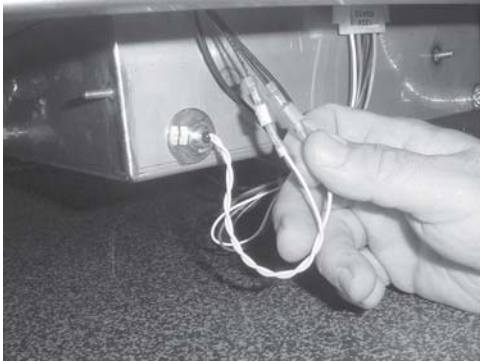

Figure 3-40



Figure 3-41



Figure 3-42



To avoid electrical shock or property damage, move the **POWER** switch to **OFF** and disconnect main circuit breaker, or unplug cord at wall receptacle.

1. Open drain valve and empty water pan into a shallow pan or floor drain. Figure 3-39.



Hot water! Do not place your hand under the drain while draining the unit. Failure to follow this warning could result in severe burns and injury.

2. Unplug wires to float switch. Figure 3-40.

3. Remove nut securing the float switch and pull float switch from unit. Figure 3-41.

4. Install new float switch in reverse order, making sure float switch is in upright position. Figure 3-42.

5. Unit is now ready for use..

3-18. HIGH LIMIT - WATER HEATER REPLACEMENT



To avoid electrical shock or property damage, move the **POWER** switch to **OFF** and disconnect main circuit breaker, or unplug cord at wall receptacle.



Figure 3-43

1. Open drain valve and empty water pan into a shallow pan or floor drain. Figure 3-43.



Hot water! Do not place your hand under the drain while draining the unit. Failure to follow this warning could result in severe burns and injury.



Figure 3-44

2. Remove all doors and racks from unit and carefully lay the unit on its back. (This step may not be necessary for units on stands.)

3. Using an 11/32” socket or wrench, remove the nuts securing the water heater cover and remove cover. Figure 3-44.



Figure 3-45

4. Remove wire from high limit. Figure 3-45.
5. Check across the terminals for continuity. If the unit is not heating, the circuit should be closed, or read no resistance. If high limit is defective, continue onto step 6.

6. Remove the 2 nuts securing the high limit and remove high limit.

7. Install new high limit in reverse order.

8. Unit is now ready for use.

3-19. WATER HEATER REPLACEMENT

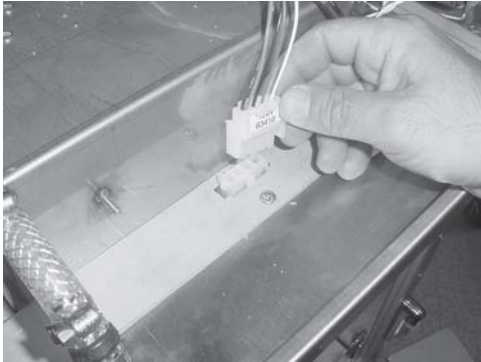

Figure 3-46



To avoid electrical shock or property damage, move the **POWER** switch to **OFF** and disconnect main circuit breaker, or unplug cord at wall receptacle.

1. Open drain valve and empty water pan into a shallow pan or floor drain. (See Figure 3-43 on page 3-16.)

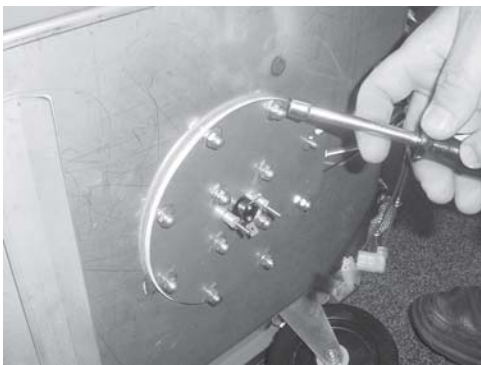

Figure 3-47



Hot water! Do not place your hand under the drain while draining the unit. Failure to follow this warning could result in severe burns and injury.

2. Remove all doors and racks from unit and carefully lay the unit on its back. (This step may not be necessary for units on stands.)

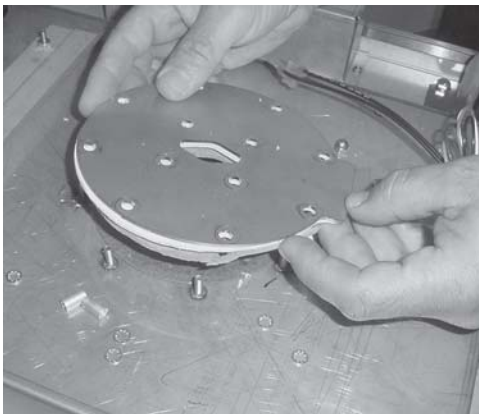

Figure 3-48

3. Using an 11/32" socket or wrench, remove the nuts securing the water heater cover and remove cover. (See Figure 3-44 on page 3-16.)

4. Unplug water heater and high limit wires. Figure 3-46.

5. Remove the nuts securing the water heater plate and high limit, and pull high limit, plate, insulation and water pan heater from the unit. Figure 3-47.

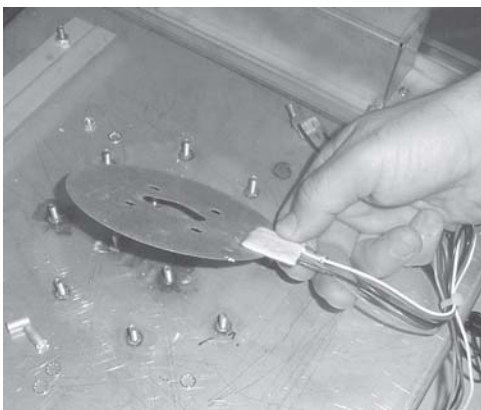

Figure 3-49

6. Pull plate and insulation from unit and discard plate and insulation. Figure 3-48.

7. Pull water heater from unit. Figure 3-49.

**3-19. WATER HEATER
REPLACEMENT
(Continued)**

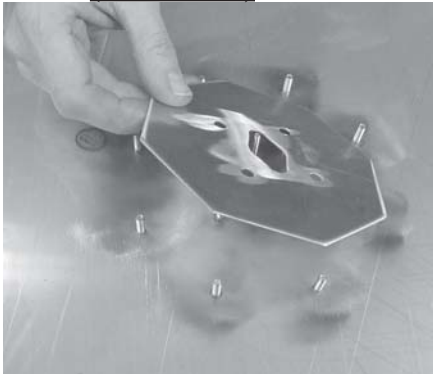

Figure 3-50



Figure 3-51

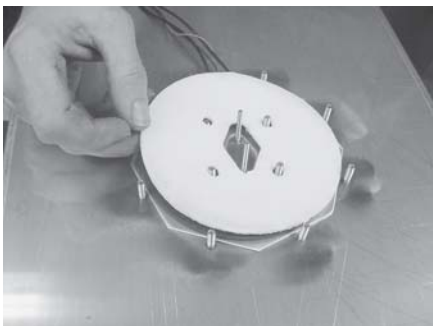

Figure 3-52

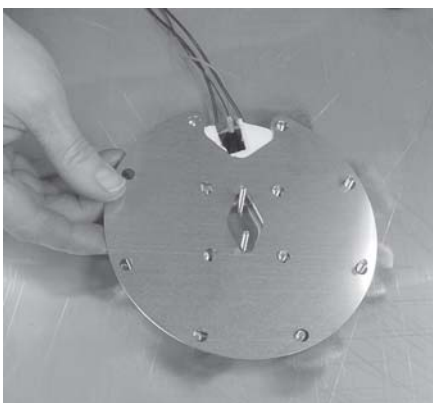

Figure 3-53

8. Locate the aluminum, octagon plate in the kit. Make sure the surface is free of debris and place the plate over the 4 long studs. Figure 3-50.

9. Install new heater, making sure the flat side is towards the plate and the soldered wires are exposed, as shown in Figure 3-51.

10. Install the new insulation from the kit, over the water pan heater. Figure 3-52.

11. Place new cover plate from the kit, over the insulation. Figure 3-53.

12. Locate the 12 keps nuts from the kit and place them over the studs and finger-tighten. Using an 11/32" socket or wrench, snug the nuts down in a cross-fashion, but **DO NOT** overtighten.

CAUTION

Overtightening the nuts could damage the coating on the heater, causing the heater to fail prematurely.

13. Reinstall high limit.

14. Reconnect high limit wires and water pan heater wires to unit.

15. Reinstall water heater cover and water supply, and unit is now ready for use.

3-20. DRAIN VALVE REPLACEMENT



To avoid electrical shock or property damage, move the **POWER** switch to **OFF** and disconnect main circuit breaker, or unplug cord at wall receptacle.

1. Open drain valve and empty water pan into a shallow pan or floor drain. (See Figure 3-43 on page 3-16.)



Hot water! Do not place your hand under the drain while draining the unit. Failure to follow this warning could result in severe burns and injury.

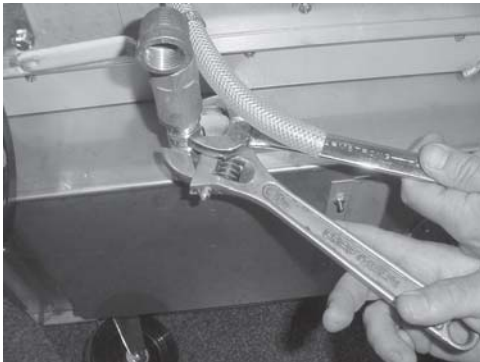

Figure 3-54

2. Remove all doors and racks from unit and carefully lay the unit on its back.
3. Loosen hose clamp on water hose and pull hose from water pan.
4. Turn drain valve handle to open position (pointed outwards).
5. Using 2 wrenches, turn drain valve counterclockwise, while holding fitting behind it. Figure 3-54. Remove drain valve assembly from unit.
6. Remove elbow from valve. (1/2-size units only)
7. Put pipe sealant on threads of elbow and install elbow in new drain valve. (1/2-size units only)
8. Put pipe sealant on threads of fitting, and install new drain valve assembly onto fitting.
9. Unit is now ready for use.

3-21. DOOR GASKET REPLACEMENT



Figure 3-55

1. Pull the gasket to the side to expose the retainer screws. Figure 3-55.
2. Loosen the screws around the outside perimeter of the gasket.
3. With all the screws loose, the gasket should slide out from under the retainers.
4. Install new gasket in reverse order and unit is now ready for use.

3-22. VENT MOTOR REPLACEMENT

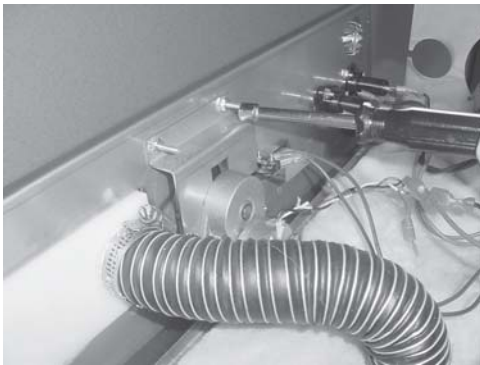

Figure 3-56



To avoid electrical shock or property damage, move the POWER switch to OFF and disconnect main circuit breaker, or unplug cord at wall receptacle.

1. Follow the instructions in Module Top Removal Section on removing the module top.
2. Using a 5/16" socket or nutdriver, remove the 4 nuts securing the bracket to the back panel. Figure 3-56.
3. Label and disconnect the wires to the vent motor.
4. Using a Phillip's-head screwdriver, remove the vent motor from the bracket. Figure 3-57.
5. Install new vent motor in reverse order.



Figure 3-57

**3-23. VENT MOTOR
MICROSWITCH
REPLACEMENT**



To avoid electrical shock or property damage, move the **POWER** switch to **OFF** and disconnect main circuit breaker, or unplug cord at wall receptacle.

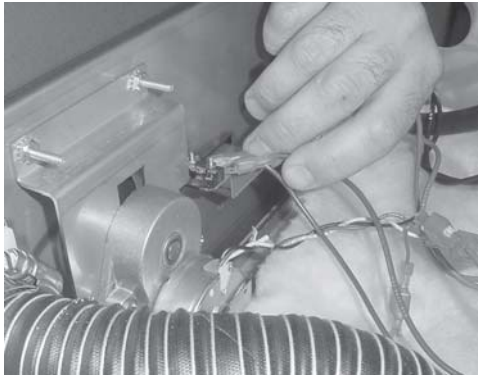

Figure 3-58

1. Follow the instructions in Module Top Removal Section on removing the module top.
2. Label and pull the wire connectors from the microswitch. Figure 3-58.
3. Using a 3/16" socket or nutdriver, remove the nuts securing the microswitch and pull microswitch from unit. Figure 5-59.
4. Install new microswitch in reverse order.

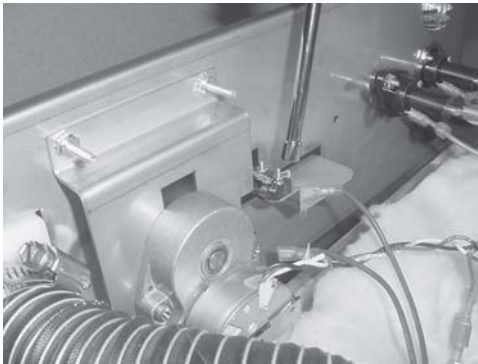
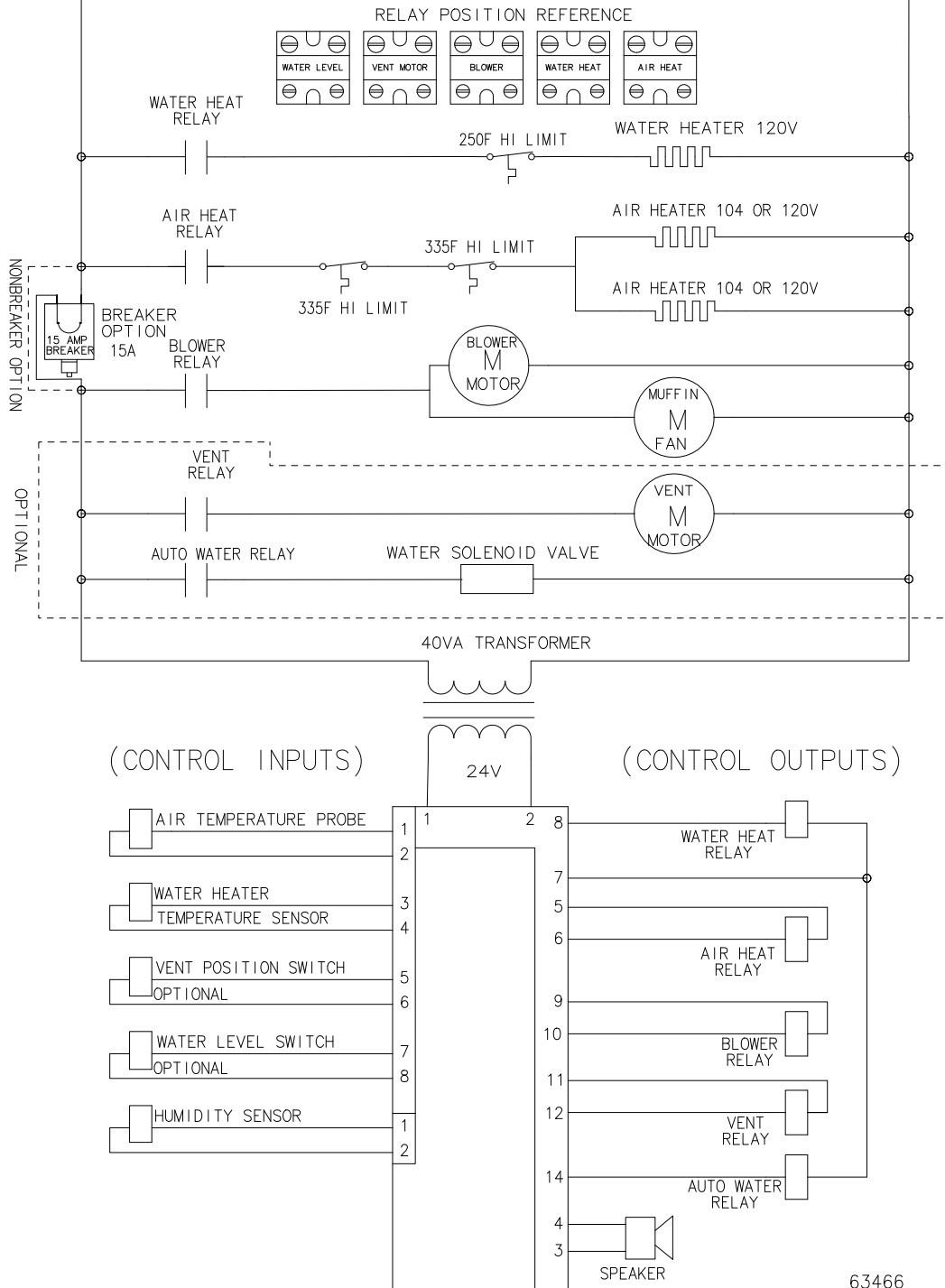
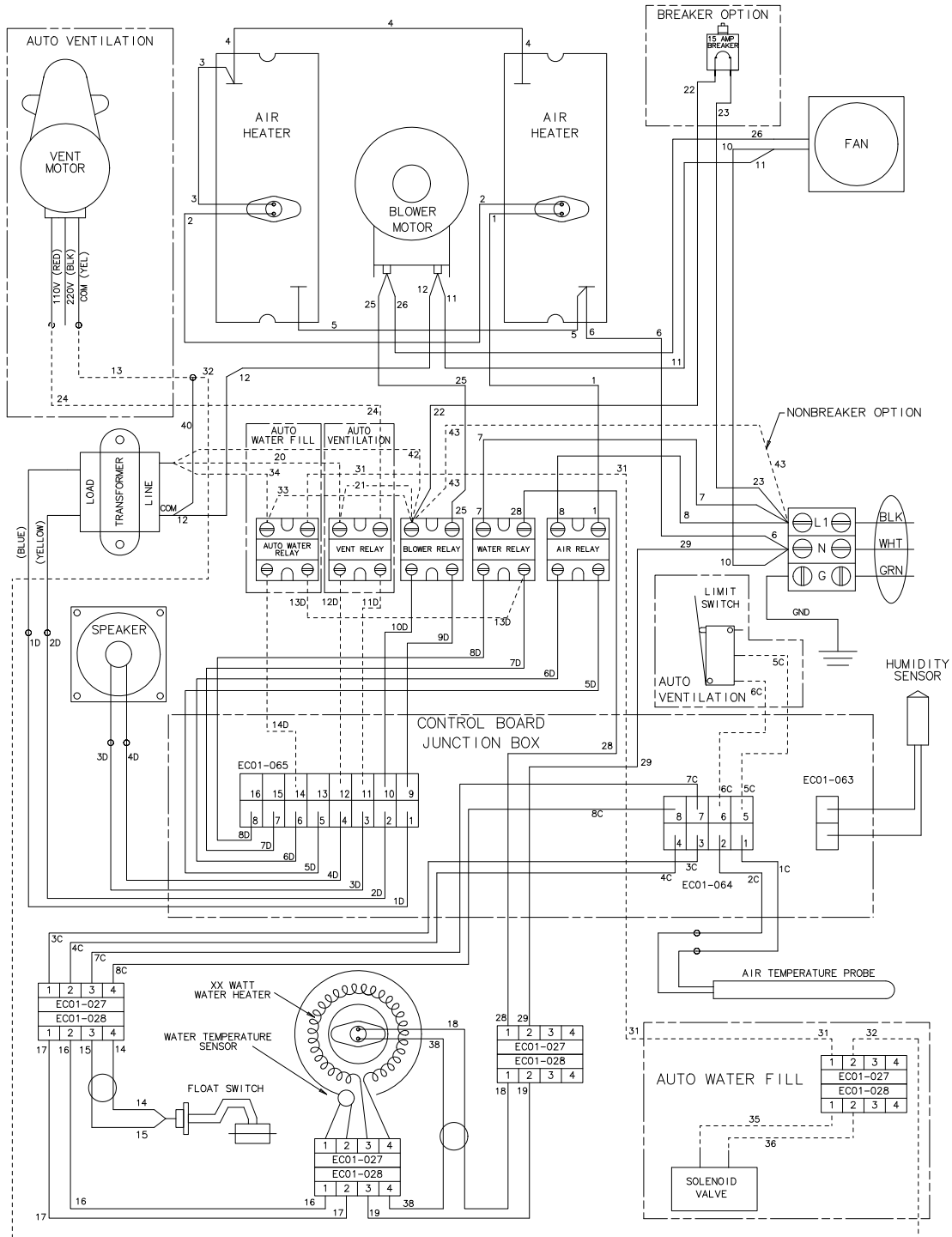

Figure 3-59



MODEL HHC99X
100/120V
50/60 Hz, 1 PH
2+G Wire





27485
120V-60hz-1ph

NOTICE

- Wiring diagram for 120V HHC-98X & HHC-99X
- Dashed lines indicate control module can be wired for either auto ventilation control or auto water fill
- Transformer: connect wire #20 (HHC-99X) or wire #34 (HHC-98X) to primary wire

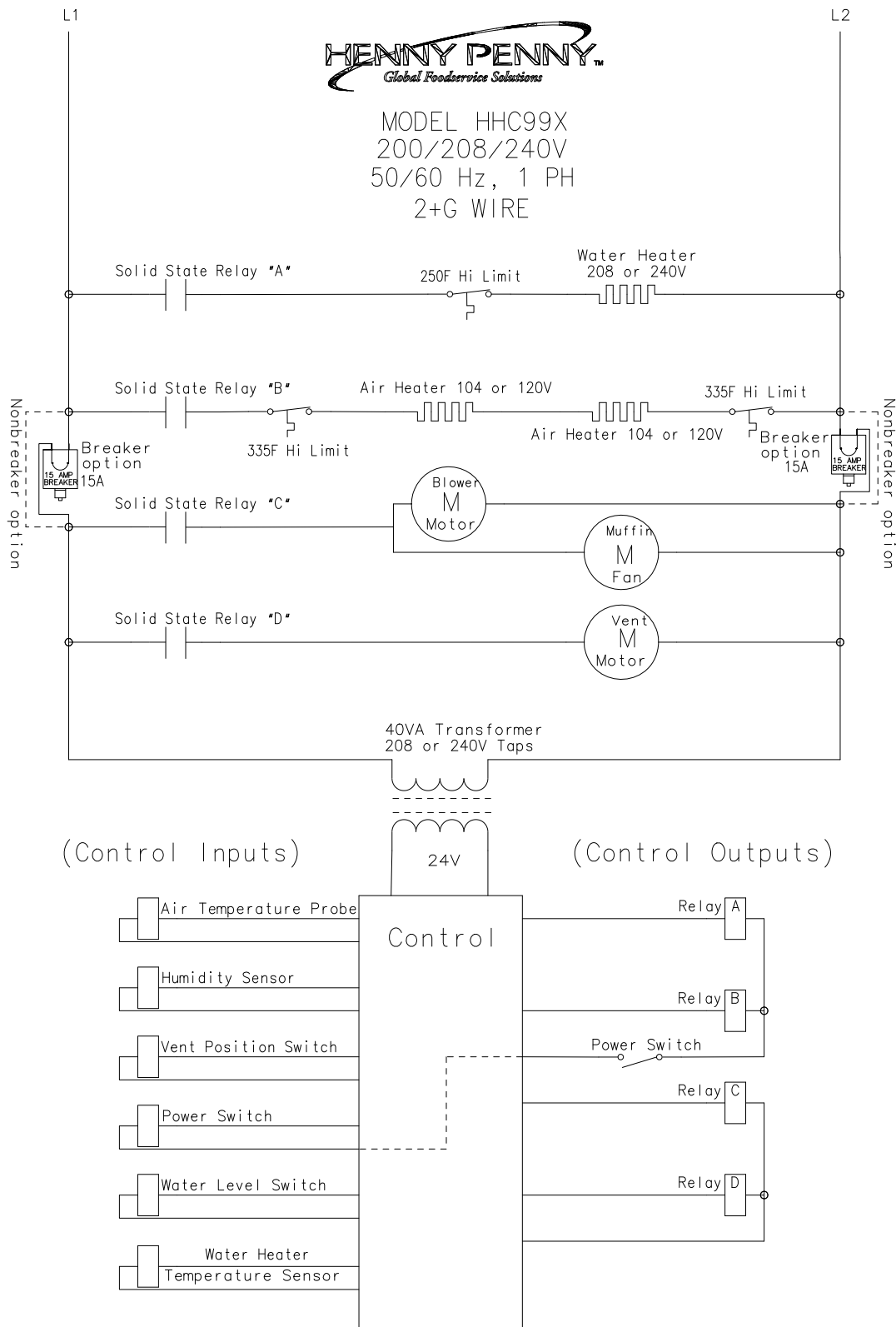

63467

63467

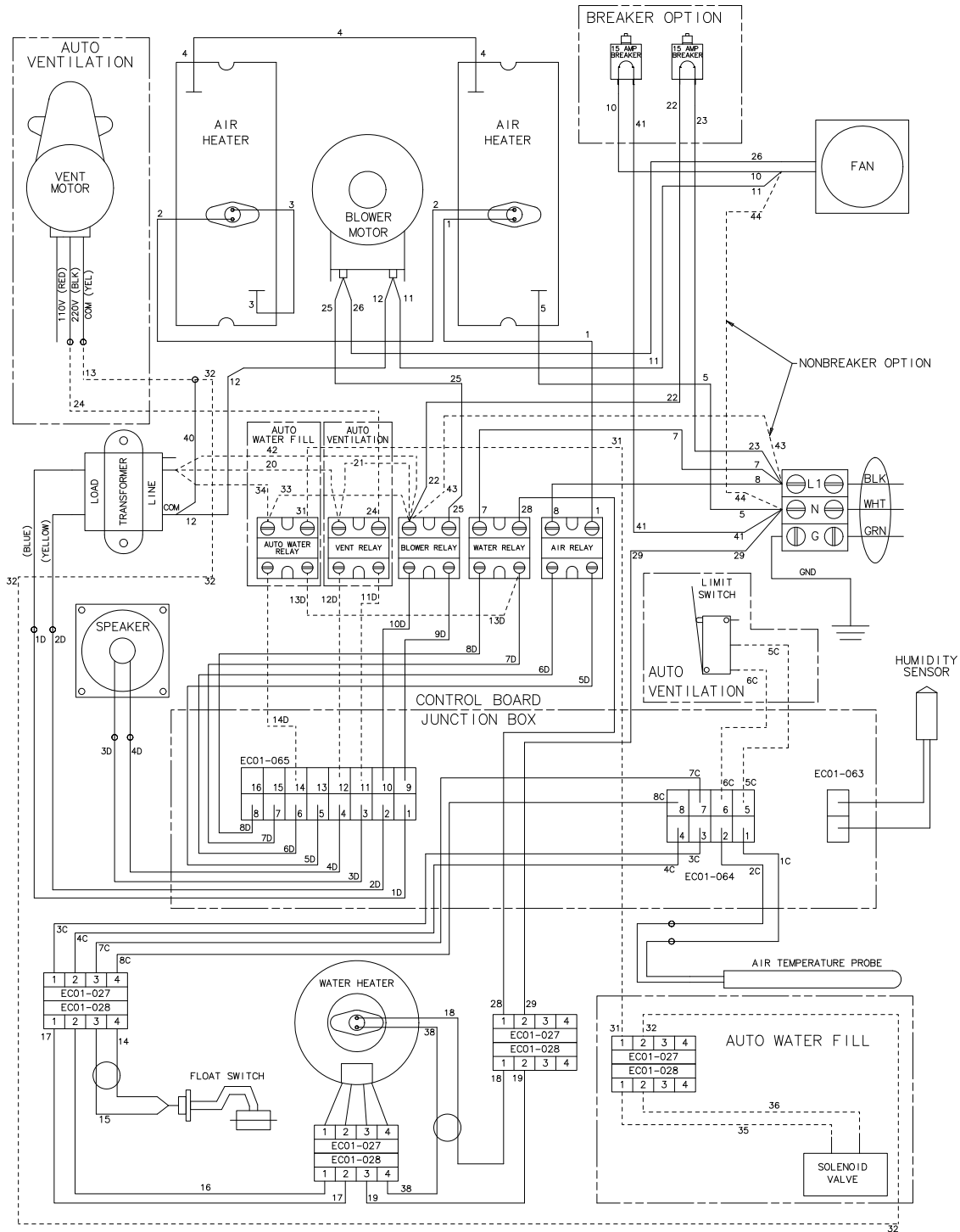

27486
208/240V-60hz-1ph

NOTICE

- Wiring diagram for 208 & 240V HHC-98X & HHC-99X
- Dashed lines indicate control module can be wired for either auto ventilation control or auto water fill
- Transformer: connect wire #20 (HHC-99X) or wire #34 (HHC-98X) to the appropriate primary wire (208 & 240V)

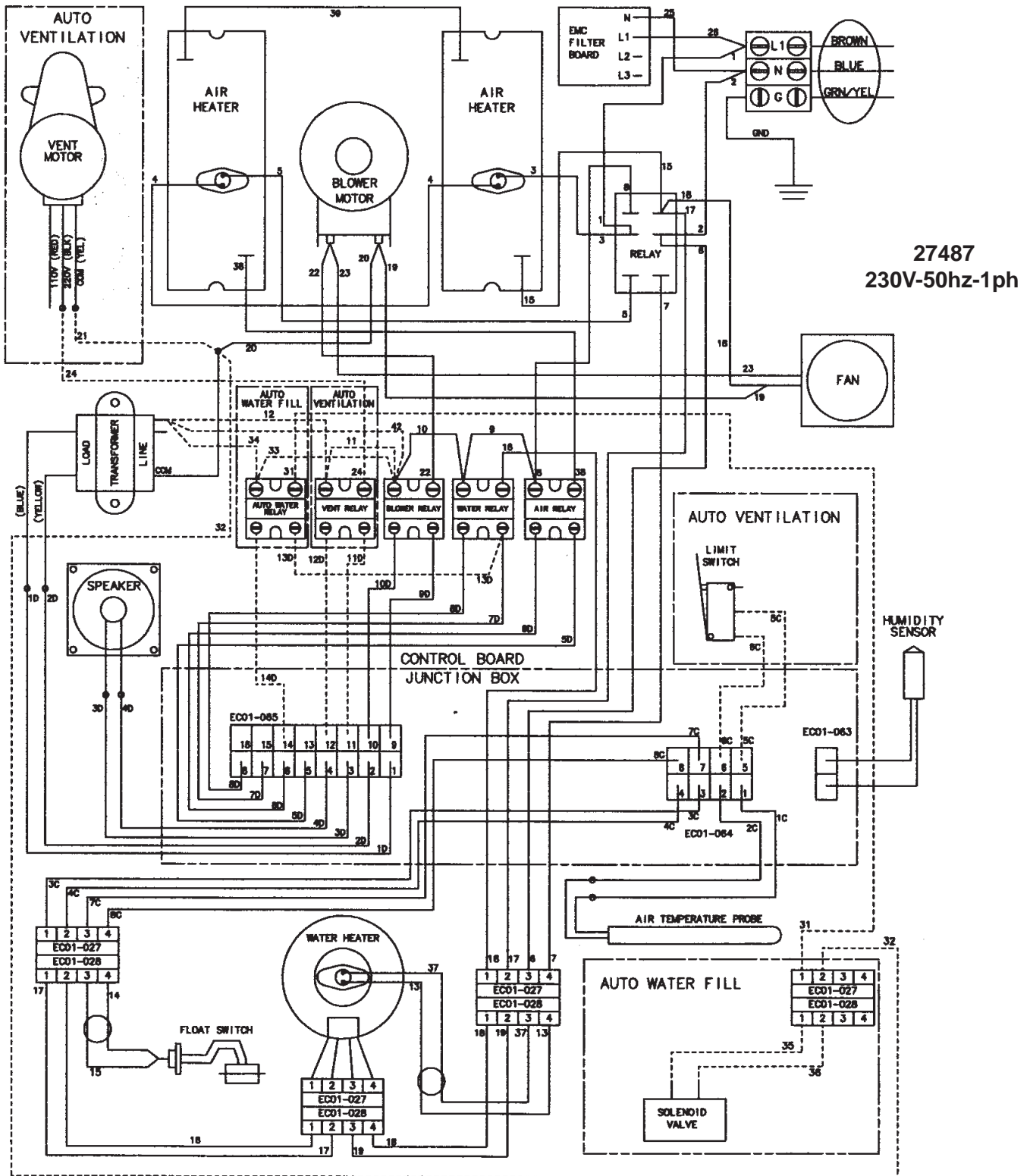

NOTICE

- Wiring diagram for 230V HHC-98X & HHC-99X
- Dashed lines indicate control module can be wired for either auto ventilation control or auto water fill
- Transformer: connect wire #12 (HHC-99X) or wire #34 (HHC-98X) to primary wire

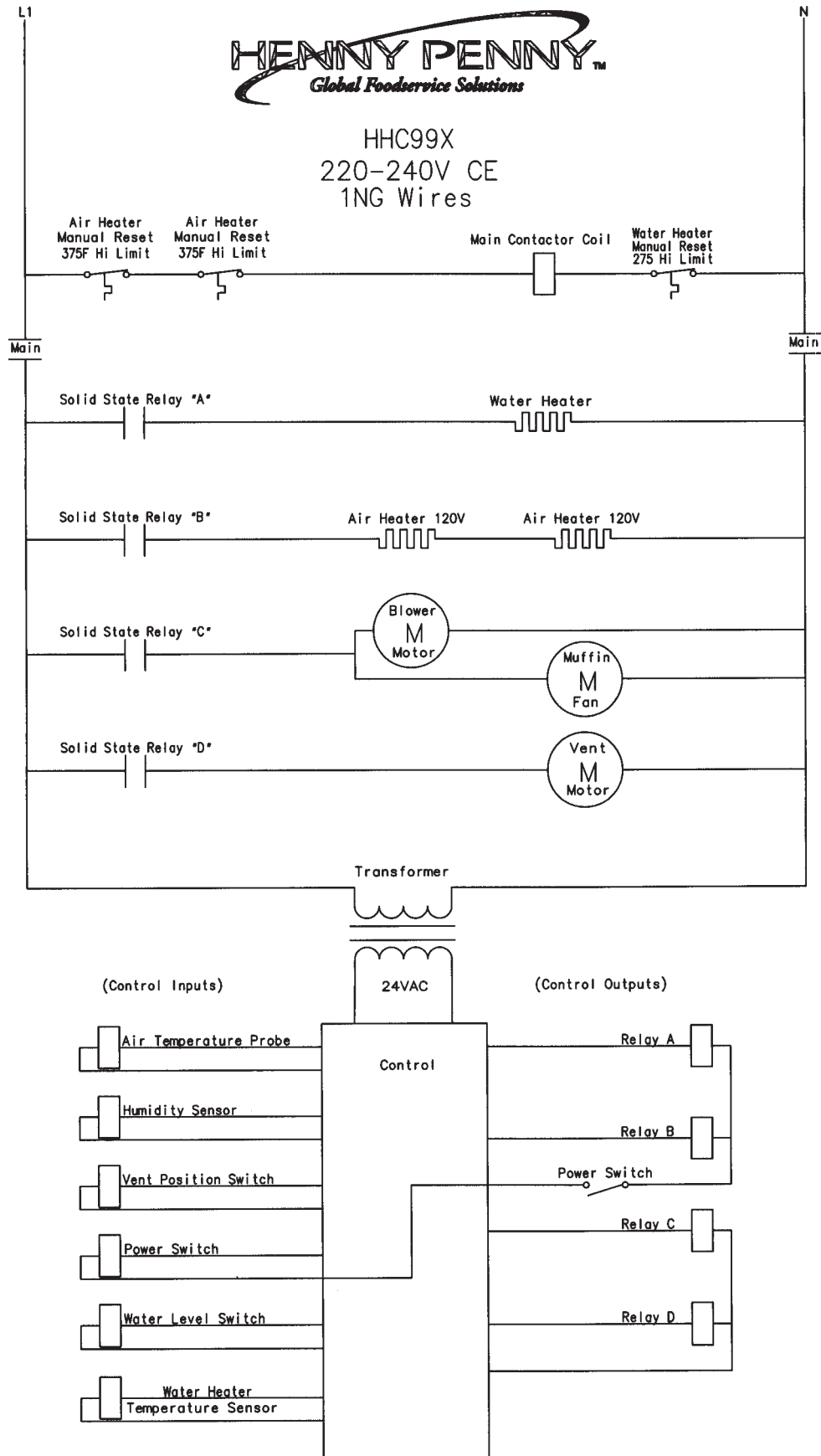

64384

SECTION 4. PARTS INFORMATION

4-1. INTRODUCTION

This section lists the replaceable parts of the Henny Penny HHC-99X.

4-2. GENUINE PARTS

Use only genuine Henny Penny parts in your cabinet. Using a part of lesser quality or substitute design may result in damage to the unit, or personal injury.

4-3. WHEN ORDERING PARTS

Once the parts that you want to order have been found in the parts list, write down the following information:

Example:	Item Number	<u>4</u>
	Part Number	<u>16684</u>
	Description	<u>Cooling Fan</u>

From data plate, list the following information:

Example:	Product Number	<u>HHC990.0</u>
	Serial Number	<u>AW001IE</u>
	Voltage	<u>208 Volt</u>

4-4. PRICES

Your distributor has a price list and will be glad to inform you of the cost of your parts order.

4-5. DELIVERY

Commonly replaced items are stocked by your local distributor and will be sent out when your order is received. Other parts will be ordered, by your distributor, from Henny Penny Corporation.

4-6. WARRANTY

All replacement parts (except lamps and fuses) are warranted for 90 days against manufacturing defects and workmanship. If damage occurs during shipping, notify the carrier at once so that a claim may be properly filed. Refer to warranty in the front of the manual for other rights and limitations.

**4-7. RECOMMENDED
SPARE PARTS FOR
DISTRIBUTORS**

Recommended replacement parts, stocked by your distributor, are indicated with √ in the parts lists. Please use care when ordering recommended parts, because all voltages and variations are marked. Distributors should order parts based upon common voltages and equipment sold in their territory.

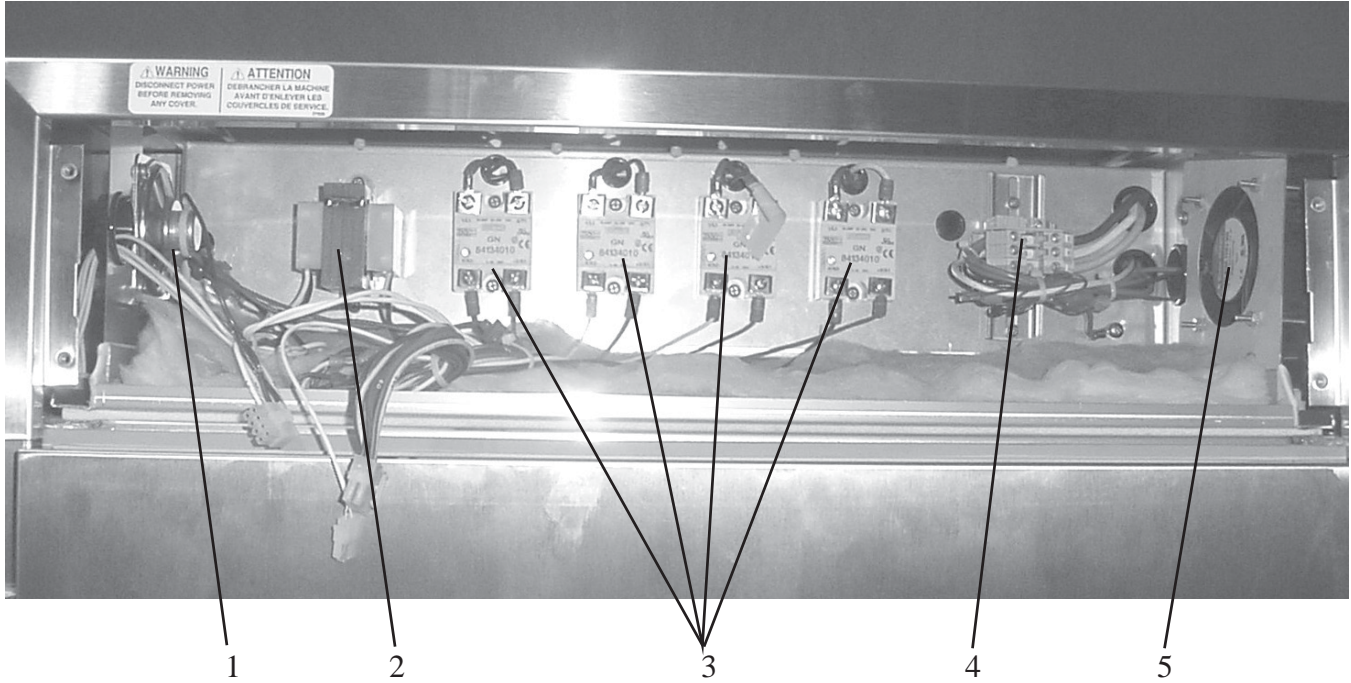
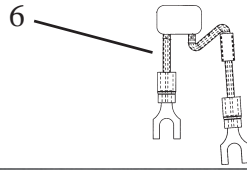

Item No.	Part No.	Description	Quantity	
			990/996	993/998
√ 1	63419	Speaker Assembly	1	1
√ 2	63460	Transformer Assembly - 120V Pri.-24 Sec.	-	1
√ 2	63459	Transformer Assembly - 208/240V Pri.-24 Sec.	1	1
√ 3	40645	Relay - 25A - Solid State	4	4
4	63832	Terminal Block Assembly	1	1
√ 5	16684	Cooling Fan Assy - 120V	-	1
√ 5	16688	Cooling Fan Assy - 220V	1	1
√ 6	66879	Assy - Resistor Capacitor	1	1
√ 7*	ME90-009	Relay - 240 VAC Coil - 30 Amp - CE	1	1

√ recommended parts

*not shown

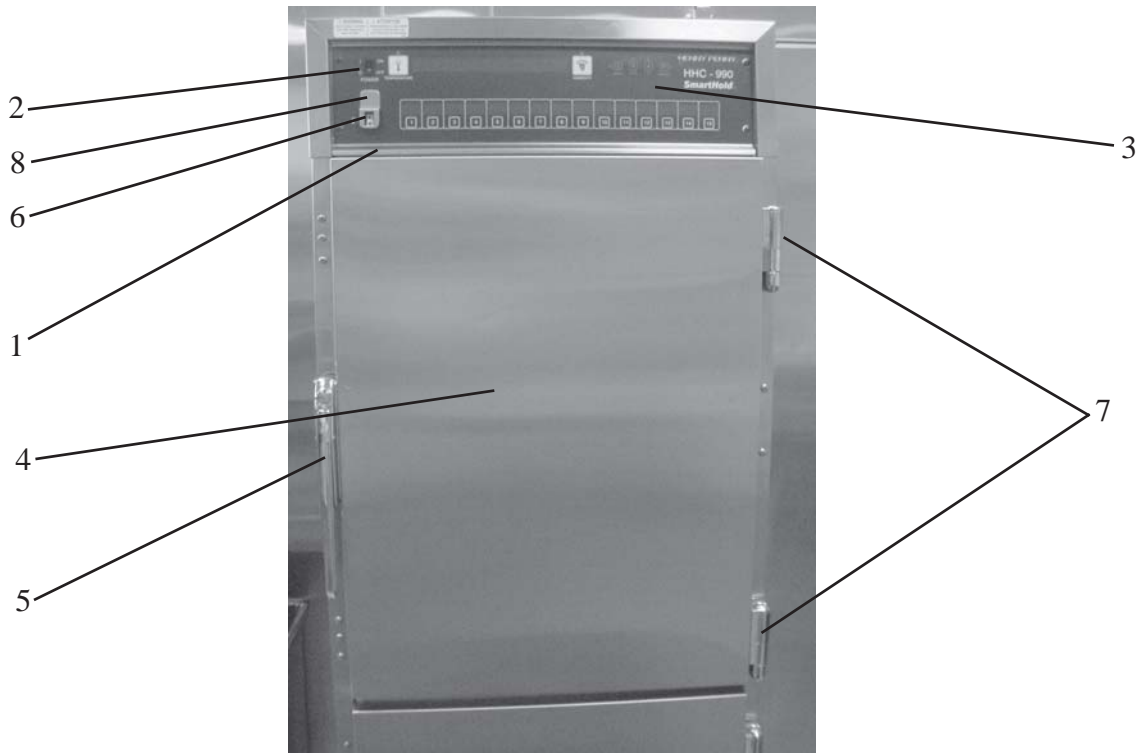

Item No.	Part No.	Description	Quantity	
			990/996	993/998
√ 1	14865	Kit - Control Board - 990 - 5 CDT	1	-
√ 1	14866	Kit - Control Board - 990 - 15 CDT	1	-
√ 1	14867	Kit - Control Board - 992/993 - 5 CDT	-	1
√ 1	14868	Kit - Control Board - 996 - 5 CDT	1	-
√ 1	14869	Kit - Control Board - 996 - 15 CDT	1	-
√ 1	14870	Kit - Control Board - 997/998 - 5 CDT	-	1
√ 2	63464	Power Switch	1	1
3	61726	Decal - Control HHC-990	1	-
3	61757	Decal - Control HHC-990 - 5 CDT	1	-
3	61759	Decal - Control HHC-996 - 5 CDT	1	-
3	61733	Decal - Control HHC-993	-	1
3	61734	Decal - Control HHC-996	1	-
3	61735	Decal - Control HHC-998	-	1
4	28816	Assy - 990 Door - RH Top	1 or 2	-
4	28817	Assy - 990 Door - RH Bottom	1 or 2	-
4	28818	Assy - 990 Door - LH Top	1 or 2	-
4	28819	Assy - 990 Door - LH Bottom	1 or 2	-
4	27033	Assy - 993 Door - RH	-	1 or 2
4	27034	Assy - 993 Door - LH	-	1 or 2
4	32774	Assy - 993 Glass Door - RH	-	1 or 2
4	32775	Assy - 993 Glass Door - LH	-	1 or 2
4	70733	Assy - 996 Door	2 or 4	-
4	70734	Assy - 998 Door	-	1 or 2
5	14272	Kit - Door Handle	2 or 4	2
6	64124	Assy - Receptacle - Food Probe	1	1
√ 6	37420	Receptacle only - Food Probe	1	1
7	14271	Kit - Door Hinge	4 or 8	4
8	56585	Assy - Stud - Probe Guard	1	1
9*	27149	Door Stops (RH-RH & LH-LH pass thru units)	4	-
10*	14327	Kit - HHC992 Stacking	-	1
10*	14328	Kit - HHC997 Stacking	-	1
11*	64355	Clip - Food Probe	1	1

√ recommended parts/*not shown

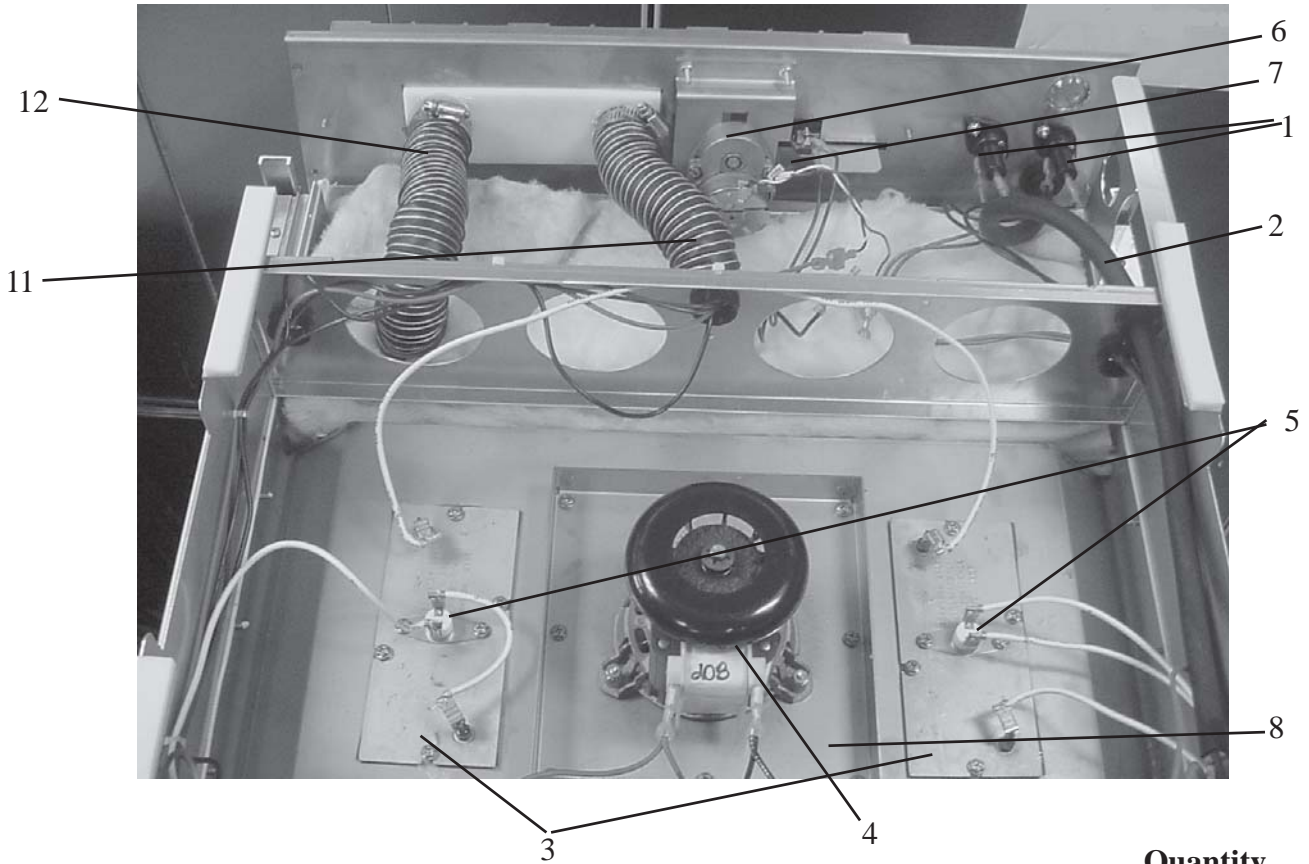

Item No.	Part No.	Description	Quantity	
			990/996	993/998
√ 1	18364	Fuse Holder Assembly (120V units have only 1 fuse)	2	2
√ 1	EF02-007	Fuse - 15 Amp	2	2
√ 1	EF02-006	Fuse Holder	2	2
2	63927	Power Cord Assembly - 120V-50A	-	1
2	63928	Power Cord Assembly - 120V-20A	-	1
2	63929	Power Cord Assembly - 208/240V-30A	-	1
2	63930	Power Cord Assembly - 208/240V-20A	1	1
2	63931	Power Cord Assembly - 208/240V-15A	1	1
√ 3	64285	Air Heater Assy-1000W-104-120V(208V units) (includes 63815 gasket)	2	-
√ 3	64128	Air Heater Assy-900W-120V - CE (includes 63815 gasket)	2	-
√ 3	64126	Air Heater Assy-600W-120V (includes 63815 gasket)	-	2
√ 4	63363	Blower - Motor 120V	-	1
√ 4	63362	Blower - Motor 208V	1	1
√ 5	18201	Sensor - High Limit - 335 Deg.	2	2
√ 5	59272	Sensor - High Limit - 375 Deg. - CE (manual reset)	2	2
√ 6	63829	Assy - Vent Motor - 110/220	1	1
√ 7	64098	Assy - Sealed Switch and Actuator	1	1
8	59496	Stud Assy- Motor Mounting Plate	1	1
9*	63814	Gasket - Plate - Motor Mounting	1	1
√ 10*	51068	Assy - EMC Filter Board	1	1
11	63461	Vent Hose-Intake	1	1
12	63462	Vent Hose-Exhaust	1	1



Quantity	Item No.	Part No.	Description	990/996	993/998
√	1	14390	Kit - Humidity Sensor (before 4/1/2005)	1	1
√	1	140135	Kit - Humidity Sensor (4/1/2005 & after)	1	1
√	2	64283	Probe-Air Temp	1	1
√	3*	14391	Kit - Calibration Board	1	1

√ recommended parts
*not shown

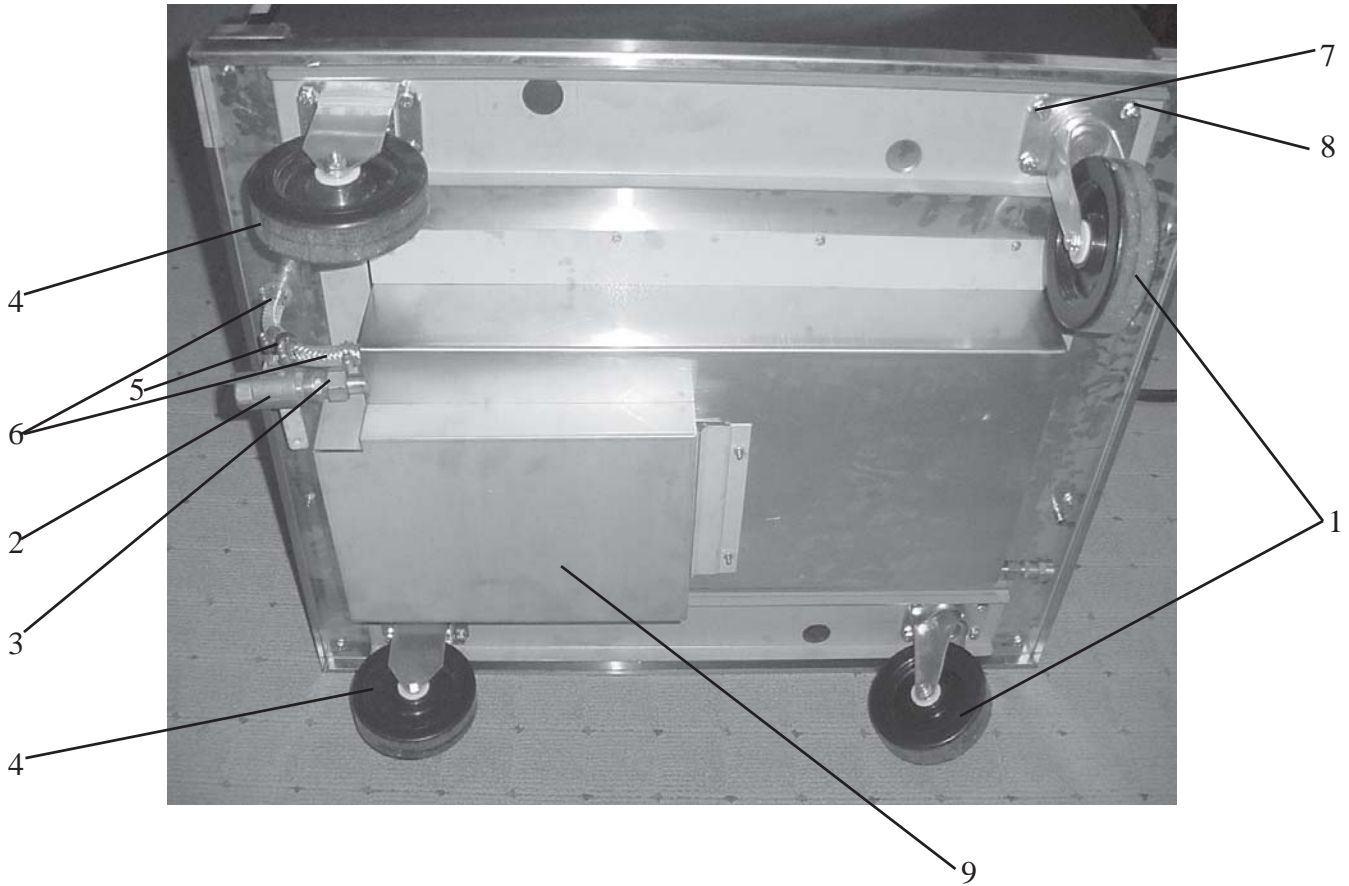

Item No.	Part No.	Description	Quantity	
			990/996	993/998
1	27155	Caster	2	2
2	63389	Valve - Drain w/Handle	1	1
3	FP01-131	Male Connector - 5/8 Tube	1	1
4	27154	Caster - Locking	2	2
5	64154	Check Valve	1 or 2	1
6	63463	Water Pan Hose	2 or 4	2
7	SC01-039	Screw - 1/4-20x1 Hex Hd C	16	16
8	LW01-002	Lockwasher - Split Ring 1/4 S	16	16
9	64351	Cover - Water Pan Heater	1	1
9	21031	Cover - Water Pan Heater - CE	1	1
10*	FP01-136	Fitting - 1/2 Barb-3/4 Male Hose (allows garden hose drain for stacked units)	-	1
11*	FP01-132	Male Hose 3/4" Hose Thread (allows garden hose drain for stacked units)	-	1
12*	64289	Drain Tube - Cabinet (drain tube for top unit on stacked units)	-	1

*not shown

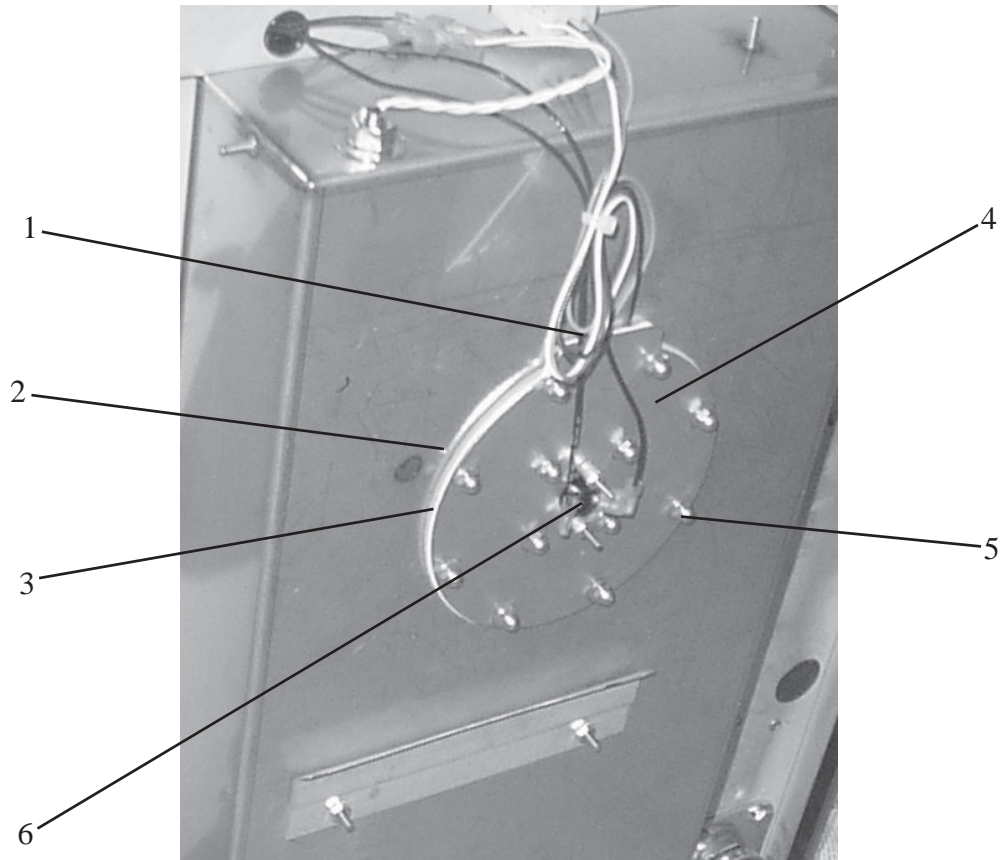

Quantity	Item No.	Part No.	Description	990/996	993/998
√	1	14631	Kit - Water Pan Heater - 120V	-	1
√	1	14632	Kit - Water Pan Heater - 208V	1	1
√	1	14633	Kit - Water Pan Heater - 240V	1	1
	2	71130	Spacer - Water Heater	1	1
	3	68130	Insulator - Water Heater	1	1
	4	67524	Plate - Water Heater Backing	1	1
	5	NS02-007	Nut Hex Keps - #8-32 C	12	12
√	6	63831	Hi Limit - Water Pan	1	1
√	6	64297	Hi Limit - Water Pan - CE (manual reset)	1	1
√ recommended parts					

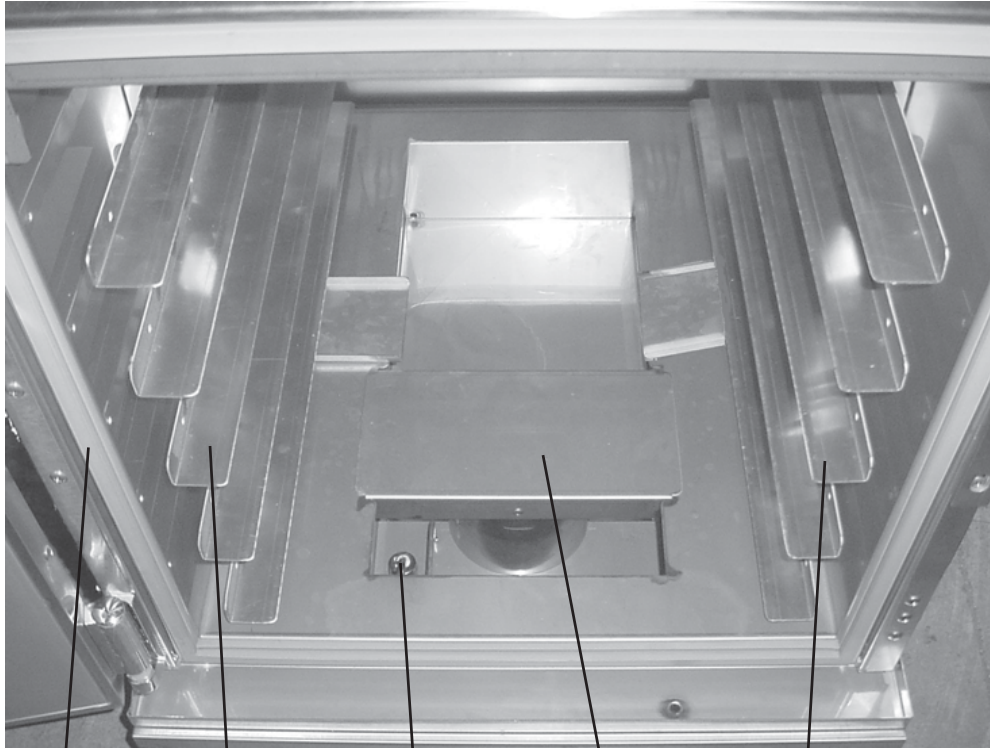

Item No.	Part No.	Description	Quantity	
			990/996	993/998
√ 1	25643	Gasket - Door - 990	2 or 4	-
√ 1	25793	Gasket - Door - 993	-	2
√ 1	28147	Gasket - Door - 996	2 or 4	-
√ 1	28143	Gasket - Door - 998	-	2
2	25957	Assy. - 993 Air Duct	-	2
2	28128	Assy. - 998 Air Duct	-	2
2	27895	Assy. - 990 Air Duct - Upper - 15 tray	2	-
2	27811	Assy. - 990 Air Duct - Lower - 15 tray	2	-
2	30880	Assy. - 990 Air Duct - Lower - 14 tray(used with 27811)	2	-
2	27894	Assy. - 990 Air Duct - Upper - 10 tray	2	-
2	27825	Assy. - 990 Air Duct - Lower - 10 tray	2	-
2	28729	Assy. - 990 Air Duct - Upper - 8 tray	2	-
2	28728	Assy. - 990 Air Duct - Lower - 8 tray	2	-
2	52345	Assy. - 990 Air Duct - Upper - KFC	2	-
2	52346	Assy. - 990 Air Duct - Upper - KFC	2	-
2	28129	Assy. - 996 Air Duct - Upper	2	-
2	28130	Assy. - 996 Air Duct - Lower	2	-
2	28133	Pan Bracket Weldment	22	-
2	34519	Duct - 996 - Air - Upper - Knotts Berry	2	-
2	34517	Duct - 996 - Air - Lower - Knotts Berry	2	-
2	34563	Assy. - Slide and Connectors - Knotts Berry	30	-
2	34550	Assy. - 996 - Air Duct - Upper	2	-
2	34545	Assy. - 996- Air Duct - Lower	2	-
√ 3	67297	Switch - Float Assembly	1	1
4	63525	Assy-Water Pan Cover & Ring (concentration ring)	1	1
4	SC01-076	Screw - #8-32 x 1/4 PH THD S	8	8
4	ME50-048	Standoff - .25 dia. x .63 lg. #8-32 SS	4	4

√ recommended parts
4-8

