



HENNY PENNY
Engineered to Last

Henny Penny

**Split Vat & Full Vat
Open Fryers – Electric
Model LVE-202
Model LVE-203
Model LVE-204**

TECHNICAL MANUAL

TABLE OF CONTENTS

Section	Page
Section 1. TROUBLESHOOTING.....	1-1
1-1 Introduction	1-1
1-2 Safety.....	1-1
1-3 Troubleshooting.....	1-2
1-4 Error Code Table	1-7
Section 2. INFO, FILTER & TEMP BUTTON STATS	2-1
2-1 INFO Button Stats	2-1
2-2 FILTER Button Stats	2-1
2-3 TEMP Button Stats.....	2-1
Section 3. LEVEL 1 PROGRAMMING.....	3-1
3-1 Modifying Product Settings	3-1
3-2 AIF Clock.....	3-3
3-3 Deep Clean Mode.....	3-4
3-4 Fryer Setup	3-5
Section 4. LEVEL 2 PROGRAMMING	4-1
4-1 Advanced Product Settings	4-1
4-2 E-Log (error code log).....	4-2
4-3 Passwords	4-3
4-4 Alert Tone (and volume)	4-3
4-5 Filter After	4-4
4-6 Filter Time	4-4
Section 5. LEVEL 3 PROGRAMMING	5-1
5-1 Additional Advanced Product Settings	5-1
5-2 Special Programming	5-2
5-3 Clock Set	5-6
5-4 Data Comm & Heat Control.....	5-6
5-5 Tech Mode.....	5-7
5-6 Stats Mode.....	5-12
Section 6. INFORMATION MODE.....	6-1
6-1 Info Mode	6-1
Section 7. MAINTENANCE SECTION.....	7-1
7-1 Intoduction	7-1
7-2 Maintenance Hints.....	7-1
7-3 Preventive Maintenance	7-1
7-4 Control Panel and Menu Card Replacement	7-2
7-5 High Temperature Limit System	7-3
7-6 Electric Heating Element	7-5
7-7 Breakers.....	7-7
7-8 Main Power Switch	7-8

TABLE OF CONTENTS

Section	Page
Section 7. MAINTENANCE SECTION (Continued)	
7-9 Temperature Probe Replacement.....	7-8
7-10 Element Sense Switch	7-11
7-11 Contactors.....	7-12
7-12 Selector Valve.....	7-14
7-13 Drain Valves	7-17
7-14 Filter Pump & Motor.....	7-18
7-15 JIB Pump	7-21
7-16 AIF PC Board.....	7-21
7-17 Transformers	7-22
7-18 Filter Motor Relay.....	7-23
7-19 Check Valve.....	7-23
7-20 Drain Pan Switch.....	7-24
7-21 Filter and JIB Lights.....	7-25
7-22 Oil Level Probes.....	7-26
7-23 Manual Operation of Drain Valve	7-28
Selector Valve Plumbing Diagrams.....	7-29
Wiring Legend.....	7-30
Control Panel Label.....	7-31
RTI/Henny Penny System Operation	7-32
Wiring Diagrams	7-33
Section 8. PARTS INFORMATION.....	8-1
8-1 Introduction	8-1
8-2 Genuine Parts	8-1
8-3 When Ordering Parts.....	8-1
8-4 Prices	8-1
8-5 Delivery	8-1
8-6 Warranty	8-1
8-7 Recommended Spare Parts Lists for Distributors	8-1

SECTION 1. TROUBLESHOOTING

1-1. INTRODUCTION

This section provides troubleshooting information in the form of an easy to read table.

If a problem occurs during the first operation of a new fryer, recheck the installation per the Installation Section of the Operator's manual.

Before troubleshooting, always recheck the operation procedures per Section 3 of the Operator's manual.

1-2. SAFETY

Where information is of particular importance or safety related, the words DANGER, WARNING, CAUTION, and NOTICE are used. Their usage is described below.



SAFETY ALERT SYMBOL is used with DANGER, WARNING, or CAUTION which indicates a personal injury type hazard.



NOTICE is used to highlight especially important information.



CAUTION used without the safety alert symbol indicates a potentially hazardous situation which, if not avoided, may result in property damage.



CAUTION indicates a potentially hazardous situation which, if not avoided, may result in minor or moderate injury.



WARNING indicates a potentially hazardous situation which, if not avoided, could result in death or serious injury.



DANGER INDICATES AN IMMINENTLY HAZARDOUS SITUATION WHICH, IF NOT AVOIDED, WILL RESULT IN DEATH OR SERIOUS INJURY.

1-3. TROUBLESHOOTING

To isolate a malfunction, proceed as follows:

1. Clearly define the problem (or symptom) and when it occurs.
2. Locate the problem in the Troubleshooting table.
3. Review all possible causes. Then, one-at-a-time work through the list of corrections until the problem is solved.
4. Refer to the maintenance procedures in the Maintenance Section to safely and properly make the checkout and repair needed.



If maintenance procedures are not followed correctly, injuries and/or property damage could result.

Problem	Cause	Correction
POWER SECTION		
<p>With power switch in ON position, the fryer is completely inoperative</p> <p>(NO POWER)</p>	<ul style="list-style-type: none"> • Open circuit 	<ul style="list-style-type: none"> • Check to see that unit is plugged in • Check the breaker or fuse at supply box • Check voltage at wall receptacle • Check MAIN POWER switch; replace if defective • Check cord and plug • Reset circuit breakers in fryer • Reset transformer circuit breaker
HEATING OF SHORTENING SECTION		
<p>Oil will not heat</p>	<ul style="list-style-type: none"> • Blown fuse or tripped • Faulty power switch. • Faulty cord and plug • Faulty drain switch • Faulty PC Board • High limit control tripped 	<ul style="list-style-type: none"> • Reset circuit breaker or replace fuse at supply box or control panel • Check power switch per maintenance section on the power switch • Check cord and plug • Check power at receptacle • Check drain switch per maintenance section on drain switches • Check control panel per maintenance section and replace as needed. • Allow heating elements to cool down (15-20 minutes), reset the high limit by pressing down and releasing the raised side of the reset switch for the vat that is not operating. If high limit does not reset, replace control.

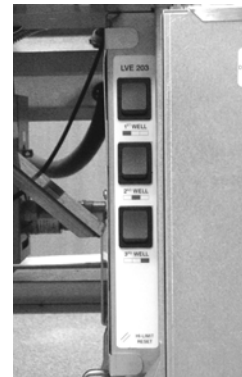

Problem	Cause	Correction
HEATING OF SHORTENING SECTION (Continued)		
Oil will not heat (Continued)	<ul style="list-style-type: none"> • Drain valve open • Possible faulty temperature probe • Faulty contactor • Breaker on fryer tripped 	<ul style="list-style-type: none"> • Close drain valve • Replace temperature probe • Check contactor per maintenance section on contactors • Check breakers on fryer per maintenance section on breakers
Oil heating too slow	<ul style="list-style-type: none"> • Low or improper voltage • Weak or burnt out element(s) • Points in contactor bad • Wire(s) loose • Burnt or charred wire connection 	<ul style="list-style-type: none"> • Use a meter and check the receptacle against data plate • Check heating element(s) per Element Replacement Section • Check contactor per Contactor Replacement Section • Tighten • Replace wire and clean connectors
Oil overheating	<ul style="list-style-type: none"> • Programming wrong • Faulty PC board • Faulty temperature probe • Check contactor for not opening 	<ul style="list-style-type: none"> • Check temperature setting in the program mode • Replace control board if heat indicator stays on past ready temperature • Check probe calibration and replace if temperature is off ± 5 degrees • Check faulty contactor per Contactor Replacement Section

Problem	Cause	Correction
OIL LEVEL SECTION		
Oil foaming or boiling over vat	<ul style="list-style-type: none"> • Water in oil • Improper or bad oil • Improper filtering • Cold zone (bottom of vat) full of crumbs • Improper rinsing after cleaning the fryer 	<ul style="list-style-type: none"> • At end of a Cook Cycle, drain and clean vat; add fresh oil • Use recommended oil • Refer to the procedure covering filtering the oil • Filter oil • Rinse the vat thoroughly to remove any cleaning agent in the vat
Oil will not drain from vat	<ul style="list-style-type: none"> • Drain valve clogged with crumbs • Faulty actuator • Drain trough clogged 	<ul style="list-style-type: none"> • Open valve, use straight white brush to force crumbs through drain valve • Replace actuator per Maintenance Section on the actuator • Remove and clean out drain trough
Oil leaking through drain valve	<ul style="list-style-type: none"> • Obstruction in drain • Faulty drain valve • Locations with RTI, the 3-way valve is stuck open 	<ul style="list-style-type: none"> • Remove obstruction • Replace drain valve • The RTI system can be disconnected until RTI repairs the valve
Vat is under-filled	<ul style="list-style-type: none"> • JIB is low or empty • JIB oil line is clogged or collapsed • Filter pan needs cleaned • Quick disconnect not engaged properly 	<ul style="list-style-type: none"> • Fill the JIB • Check JIB line • Clean filter pan and change pad • Disconnect and reconnect quick disconnect fitting
Bubbles in oil during entire filtering process	<ul style="list-style-type: none"> • Filter pan not completely engaged • Filter pan clogged • Damaged o-ring on filter line tube on fryer 	<ul style="list-style-type: none"> • Make sure filter pan return line is pushed completely into the receiver on the fryer • Clean pan and change pad • Change O-ring

Problem	Cause	Correction
FILTER MOTOR SECTION		
Filter motor runs but pumps oil slowly	<ul style="list-style-type: none"> • Filter line connections loose • Drain pan o-rings damaged or missing • Filter paper or pad clogged 	<ul style="list-style-type: none"> • Tighten filter line connections • Install new o-rings • Change filter paper or pad
Filter motor will not run	<ul style="list-style-type: none"> • Power cord for vat #1 is not plugged-in • Thermal reset button on the rear of the pump motor is tripped 	<ul style="list-style-type: none"> • Plug power cord into receptacle • Allow time for the motor to cool and then, using a screwdriver, press hard against the button until it clicks <div data-bbox="1036 863 1455 1077" style="text-align: center;"> </div>
DISPLAYED PROMPT SECTION		
“IS POT FILLED” filter error prompt	<ul style="list-style-type: none"> • All oil did not completely return after a filter cycle • Filter pad clogged 	<ul style="list-style-type: none"> • Have manager follow prompts • Is JIB full? If not, fill JIB • Replace filter pad/clean pan.
“CHECK PAN” prompt	<ul style="list-style-type: none"> • Filter pan missing • Filter pan not completely engaged • Filter pan interlock not engaged 	<ul style="list-style-type: none"> • Find pan and install • Adjust filter pan • Check microswitch
“CHANGE FILTER PAD” prompt appears	<ul style="list-style-type: none"> • Pad has not been changed within a 24 hr period; Main power switch was turned off during filter pad change • Drain pan microswitch stuck 	<ul style="list-style-type: none"> • Replace pad with NEW filter pad with main power switch on. *NOTE* 24/7 store : Replace filter twice a day. • Check microswitch

1-4. ERROR CODES

In the event of a control system failure, the digital display shows an error message. The message codes are shown in the DISPLAY column below. A constant tone is heard when an error code is displayed, and to silence this tone, press any button.

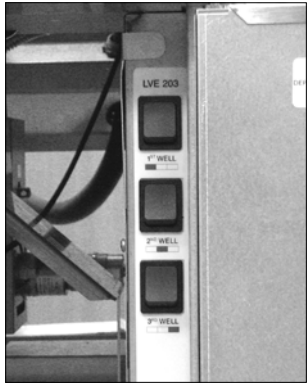
DISPLAY	CAUSE	CORRECTION
“E-4”	Control board overheating	Turn switch to OFF position, then turn switch back to ON; if display shows “E-4”, the control board is getting too hot; check the louvers on each side of the unit for obstructions
“E-5”	Oil overheating	Turn switch to OFF position, then turn switch back to ON; if display shows “E-5”, the heating circuits and temperature probe should be checked
“E-6A”	Temperature probe open	Turn switch to OFF position, then turn switch back to ON; if display shows “E-6A”, the temperature probe should be checked
“E-6B”	Temperature probe shorted	Turn switch to OFF position, then turn switch back to ON; if display shows “E-6B”, the temperature probe should be checked
“E-10”	High limit	Allow heating elements to cool down (15-20 minutes), reset the high limit by pressing down and releasing the raised side of the reset switch for the vat that is not operating. If the high limit does not reset, replace defective high limit control 
“E-18-A” “E-18-B” “E-18-C”	Left level sensor open Right level sensor open Both level sensors open	Turn switch to OFF position, then turn switch back to ON; if display still indicates failed sensor, have connectors checked at control board; have sensor checked & replace if necessary
“E-21”	Slow heat recovery	Have a certified service technician check the fryer for correct voltage to the unit; have the contactors and heating element checked; have unit checked for loose or burnt wires

1-4. ERROR CODES (Continued)

DISPLAY	CAUSE	CORRECTION
“E-22”	Heat Error-No Heat	Check power cord and have heat circuit checked
“E-31”	Elements are up	Lower elements back into the vat
“E-41”, “E-46”	Programming failure	Turn switch to OFF, then back to ON; if display shows any of these error codes, have the controls re-initialized; if error code persists, have the control board replaced
“E-47”	Analog converter chip or 12 volt supply failure	Turn switch to OFF, then back to ON; if “E-47” persists, have the I/O board, or the PC board replaced
“E-48”	Input system error	Turn switch to OFF, then back to ON; have control PC board replaced if “E-48” persists
“E-54C”	Temperature input error	Turn switch to OFF, then back to ON; have control PC board replaced if “E-54C” persists
“E-60”	AIF PC board not communicating with control PC board	Turn switch to OFF, then back to ON; if “E-60” persists, have the 1.5 amp fuse on the AIF PC board checked; have the connector between the PC boards checked; replace AIF PC board or control PC board if necessary
“E-70C”	Drain valve jumper wire missing or disconnected	Have the jumper wire checked on the PC board at drain switch interlock position
“E-82A”	Selector Valve not detected	Have wiring checked between Selector Valve and AIF board
“E-82B”	Selector Valve Failed	Have the “Home” switch on Selector Valve checked
“E-82C”	Selector Valve Failed	Have wiring checked between the “Home” & “Position” switches and the Selector Valve; Have Selector Valve Motor checked; Have drive chain checked
“E-82D”	Selector Valve Failed	Have wiring checked between the “Home” & “Position” switches and the Selector Valve; Have Selector Valve switches and motor checked; Have drive chain checked

1-4. ERROR CODES (Continued)

DISPLAY	CAUSE	CORRECTION
“E-83”	E-83 Pressure Too High	Check power cord and have heat circuit checked
“E-83A”	Pressure too high Vat #1 during filtering	Check AIF system in Vat #1
“E-83B”, “	Pressure too high Vat #2 during filtering	Check AIF system in Vat #2
“E-83C”	Pressure too high Vat #3 during filtering	Check AIF system in Vat #3
“E-83D”	Pressure too high Vat #4 during filtering	Check AIF system in Vat #4
“E-83E”	Pressure too high Vat #5 during filtering	Check AIF system in Vat #5
“E-83J”	RTI “JIB FILL” switch ON and pressure too high	Have JIB fill valves checked
“E-83R”	RTI “DISPOSE” switch ON and pressure too high	Check RTI quick-disconnect behind fryer; RTI phone no. switch ON when if needed: 888-796-4997
“E-93A”	24VDC Tripped	Have motors for drain valves and selector valve checked

SECTION 2. INFO, FILTER & TEMP BUTTON STATS

2-1. INFO BUTTON STATS

Recovery Information for each Vat

1. Press and release  and REC shows in left display and the recovery time that oil temperature went from 250°F (121°C) to 300°F (149°C) shows in the right display. For example,

REC	5:30
-----	------



 means it took 5 minutes and 30 seconds for the oil temperature to recover to 300°F (149°C) from 250°F (121°C).
2. Pressing the  button twice shows 1st language in left display and, if programmed, 2nd language in right display.

NOTICE

If no buttons are pressed within 5 seconds in any of stats modes, the controls revert back to normal operation.

2-2. FILTER BUTTON STATS



Cook Cycles Remaining before Filtering

1. Press and release either  or  and the left display shows “COOKS REMAIN” and right display shows the number of cook cycles before the next auto filter. For example,



REMA IN	3	6
---------	---	---

 means after 3 more cook cycles on the left vat, the controls ask operator if they are ready to filter or not. But, 6 more cook cycles remain on the right vat.

Time and Date

2. Press either  or  twice and time-of-day and date shows in the displays.

Filter Pad Usage

3. Press either  or  three times and number of hours the present filter pad has been used is shown in displays.

2-3. TEMP BUTTON STATS

Actual Oil Temperature

1. Press  and actual oil temperature shows in display, for each vat.

Set-point Temperature



2. Press  twice and SP shows in the display, along with the set-point (preset) temperature of each vat.

SECTION 3. LEVEL 1 PROGRAMMING





Level 1 contains the following:

- Modify product settings
- Set the AIF clock for products
- Perform the Deep Clean procedure
- Fryer Setup Mode

3-1. MODIFYING PRODUCT SETTINGS

1. Press and hold  and  buttons until LEVEL - 1 shows in the display, followed by ENTER CODE.
2. Enter code 1, 2, 3, 4 (first 4 product buttons). “PRODUCT” and “SELECTN” show in the displays.
3. Press right $\sqrt{}$ button and ‘SELECT PRODUCT’ and “-P 1-” (ex: NUGGETS) show in the displays.



Change Product Names

4. Use the  and  buttons to scroll through 40 products, or press desired product button .
5. Press right $\sqrt{}$ button and product (ex: NUGGETS) shows in the left display and “MODIFY”, and “YES NO” shows in right display. Press the $\sqrt{}$ button to change this product, or press the **X** button to choose another product.
6. If $\sqrt{}$ button was pressed, press and release a product button and the flashing letter changes to the first letter under the product button that was pressed. For example, if  is pressed, the flashing letter changes to an “A”.

Press the same button again and flashing letter changes to a “B”. Press it again and the flashing letter changes to a “C”. Once the desired letter shows in the display, press  button to continue to the next letter and repeat procedure.

Press and hold the right **X** button to exit Program Mode, or press  button to continue on to “1. COOK TIME”.

To Change Times and Temperatures

7. Press  button until “COOK TIME” shows in display, and then use product buttons  to change time in minutes and seconds, to a maximum of 59:59.

3-1. MODIFYING PRODUCT SETTINGS (Continued)

- Press and release ▼ button and “TEMP” shows in the display, along with the preset temperature on the right side of the display.

Press the product buttons  to change the temperature. The temperature range is 190°F (88°C) to 380°F (193°C).

Cook ID Change

- Press ▼ button until “COOK ID” shows in the display along with the product ID. For example, NUG would be the ID for nuggets. Use the product buttons to change the ID, following the same procedure as Step 6 above.

Alarms (Duty 1 & 2)

- Press ▼ button until “DUTY 1” shows in left display, and an alarm time in right display. Press product buttons  to set an alarm.

Ex., If a Cook Cycle was set at 3 minutes, and an alarm was to go off after 30 seconds into the Cook Cycle, “0:30” would be set in display at this time. When the timer counts down to 2:30 the alarm sounds.

After alarm time is set, press ▼ button and “DUTY 2” shows in display, and a second alarm can be programmed.

Quality Timer

- Press ▼ button until QUAL TMR shows in display along with preset holding time. Press product buttons to adjust  hold time (2 hrs., 59 min. max.).

AIF Disable

- Press ▼ button until “AIF DISABLE” shows in display along with “YES” or “NO”. Using ◀ and ▶ buttons, change display to “YES” if that product is not to be included in automatic intermittent filtration operation, or “NO” if it is to be included.

Assign Button

- Press ▼ button until “ASSIGN BTN” shows in display, along with product (ex: NUGGETS). If this product already has a product button assigned to it, that LED will be lit. To assign other product buttons to that product, press and hold product button for 3 seconds and that LED stays lit. To remove a product from a button, press and hold product button with a lit LED and the LED goes out.



3-2. AIF CLOCK

This feature allows the controls to be set for periods of the day that block the automatic “Filter Now” prompts. For example, the controls could be set to not interrupt with “Filter Now” prompts during the lunch rush, and during the supper rush. But, if filtering is desired during this time, press and hold a  button to access the filter menu.

Each AIF Blocking period is defined by a start time (a time of day, XX:XX A, etc) and a duration in minutes.

Weekdays M-F are all grouped together. Up to four different AIF blocking periods may be programmed throughout the day for Monday - Friday. (All days share the same settings.)

A separate set of four blocking periods may be programmed for Saturdays, and a final set of four blocking periods may be programmed for Sundays.

1. Press and hold  and  buttons until LEVEL - 1 shows in display, followed by ENTER CODE.
2. Enter code 1, 2, 3, 4 (first 4 product buttons). “PRODUCT” and “SELECTN” show in the displays.
3. Press ▼ button once and “AIF CLOCK” shows in the displays.
4. Press √ button and use ◀ and ▶ buttons to scroll through “ENABLE” and “DISABLE” and press √ button again to select one.
5. If “ENABLE” is chosen, ▲ and ▼ buttons can be used to scroll through the following list of blocking periods:

Left Display	Right Display
M-F 1	XX:XX A XX
M-F 2	XX:XX A XX
M-F 3	XX:XX A XX
M-F 4	XX:XX A XX
SAT 1	XX:XX A XX
SAT 2	XX:XX A XX
SAT 3	XX:XX A XX
SAT 4	XX:XX A XX
SUN 1	XX:XX A XX
SUN 2	XX:XX A XX
SUN 3	XX:XX A XX
SUN 4	XX:XX A XX

3-2. AIF CLOCK
(Continued)

In 12-hour clock mode, there are three items on each line: the start time “XX:XX”, the A or P (am/pm) setting, and the “XX” duration. Use the ◀ and ▶ buttons to set these items, which flashes when the item is selected.

To set a new start time setting, use the product buttons,



to enter the new value.

Press the ▶ button to step over to the AM/PM setting. The A or P can be toggled by pressing the ‘0’ product button.

Press the ▶ button again to step over to the duration value (in minutes). Enter a new value using the product buttons,



NOTICE

In 24-hour clock mode, there are only two items on each line: the time (XX:XX) and the duration (XX). Again, the ◀ and ▶ buttons step you between these items.



Press the right-side X button to exit out of AIF Clock programming mode.

3-3. DEEP CLEAN MODE

This procedure allows a thorough cleaning of the vat by removing caramelized oil from vat. See Section 4-3 in the Operator’s Manual for complete set of instructions.

3-4. FRYER SETUP

This mode has the same settings as seen upon initial start-up of the fryer.

1. Press and hold  and  buttons until LEVEL - 1 shows in the display, followed by ENTER CODE.
2. Enter code 1, 2, 3, 4 (first 4 product buttons). “PRODUCT” and “SELECTN” show in the displays.
3. Press ▼ button 3 times and “FRYER SETUP” shows in displays.
4. Press √ button and *SETUP* *MODE* shows in displays, followed by, “LANGUAGE” on left display, “ENGLISH” on right display.

Use ◀ or ▶ buttons to change the operation display to, “FRANCAIS”, “CAN FREN”, “ESPANOL”, “PORTUG”, “DEUTSCHE”, “SVENSKA”, “РУССКИЙ”.

Press ▼ to continue with other set-up items which include:

- ZONE - USA or NON-USA
- TEMP FORMAT - °F or °C
- TIME FORMAT - 12-HR OR 24-HR
- ENTER TIME - Time of day (use product buttons to change)
- ENTER TIME - AM OR PM
- DATE FORMAT - US OR INTERNATIONAL
- ENTER DATE - Today’s date (use product buttons to change)
- FRYER TYPE - GAS or ELEC
- VAT TYPE - FULL OR SPLIT
- DISPOSE BULK OIL - YES/NO (BULK has RTI system)
- SUPPLY BULK OIL - YES/NO (BULK has RTI system)
- DAYLIGHT SAVING TIME - 1.OFF; 2.US (2007 & after); 3.EURO; 4.FSA (US before 2007)





Unless otherwise indicated, use ◀ or ▶ to change settings.

SECTION 4. LEVEL 2 PROGRAMMING

Used to access the following:

- Advanced changes to product settings
- Error code log
- Password programming
- Alert Tone/Volume
- No. of cook cycles before filter is suggested
- Automatic filter time



4-1. ADVANCED PRODUCT SETTINGS

1. Press and hold  and  buttons until LEVEL - 2 shows in the display, followed by ENTER CODE.
2. Enter code 1, 2, 3, 4 (first 4 product buttons). “PROD” and “COMP” show in the displays.
3. Press right $\sqrt{}$ button and ‘SELECT PRODUCT’ and “-P 1-” show in the displays.
4. Use the  and  buttons to scroll through 40 products, or press the desired product button
5. Press right $\sqrt{}$ button and product (ex: NUGGETS) shows in left display and “MODIFY” “YES NO” shows in right display. Press the $\sqrt{}$ button to change this product, or press the **X** button to choose another product.



>Load Compensation, Load Compensation Reference, Full Heat, PC Factor<

6. If $\sqrt{}$ button was pressed, “LD COMP” shows in the display along with the load compensation value. This automatically adjusts the time to account for the size and temperature of the cooking load.

Press product buttons  to change this value of 0 to 20.

7. Press  button until “LCMP REF” shows in display along with the load compensation average temperature. (If load compensation is set to “OFF”, then “_ _ _” shows in display and setting can’t be programmed.) This is the average cooking temperature for each product. Timer speeds up at temperatures above this setting and slows down at temperatures below this setting. Press product buttons  to change this value.



4-1. ADVANCED PRODUCT SETTINGS (Continued)

8. Press ▼ button until “FULL HT” shows in display along with full heat value in seconds, which means the heat is on as soon as a timer button is pressed, for programmed length of time. Press product buttons  to change this value of 0 to 90 seconds.
9. Press ▼ button until “PC FACTOR” shows in display along with proportional temperature, which helps to keep oil from over-shooting setpoint temperature. Press product buttons  to change this value of 0 to 50 degrees.

NOTICE

- Use ▲ button to go back to previous menu items.
- Press X button when finished with the current product, to return to the PRODUCT SELECTN step.
- Press X button a second time to exit PROD COMP mode.

4-2. E-LOG (error code log)



1. Press and hold  and  buttons until LEVEL - 2 shows in the display, followed by ENTER CODE.
2. Enter code 1, 2, 3, 4 (first 4 product buttons). “PROD” and “COMP” show in the displays.
3. Press ▼ button and “E-LOG” shows in the display.
4. Press right √ button and “A” plus the present date & time flashes on the display, along with “*NOW*”.
5. Press ▼ and if an error was recorded, “B” and date, time, and error code information shows in display. This is the latest error code that the controls recorded.
6. Press ▼ and next latest error code information can be seen. Up to 10 error codes (B to K) can be stored in E-Log Section.

NOTICE





Press and hold right √ button to view a brief description of the error.

4-3. PASSWORDS

The 4-digit passwords can be changed for access to Set-Up, Usage, Level 1, Level 2, & Get Mgr.)



1. Press and hold  and  buttons until LEVEL - 2 shows in the display, followed by ENTER CODE.
2. Enter code 1, 2, 3, 4 (first 4 product buttons). “PROD” and “COMP” show in the displays.
3. Press ▼ button twice and “PASSWORD” shows in the display.
4. Press right √ button and “SET UP” shows in display. The Set up password can be changed at this time, or press ▼ once to change USAGE password, twice for LEVEL 1 password, 3 times for LEVEL 2 password, or 4 times for GET MGR password. And then, follow instructions below.
5. If password for the Set Up Mode (for example) is to be changed, press right √ button and “MODIFY? “YES NO” shows in display. Press right √ button to change 4-digit password for Set Up Mode, using the product buttons  .
6. Once new password is entered, “CONFIRM PASSWORD” shows in the display. Press √ button to confirm, or press X to choose another password.

4-4. ALERT TONE (and volume)

1. Press and hold  and  buttons until “LEVEL - 2” shows in the display, followed by “ENTER CODE”.
2. Enter code 1, 2, 3, 4 (first 4 product buttons). “PROD” and “COMP” show in the displays.
3. Press ▼ button 3 times and “ALERT TONE” shows in display.
4. Press right √ button and “VOLUME” shows in the display, along with volume value. Use product buttons  to set volume from 1 (softest) to 10 (loudest).
5. Once volume is set, press √ button and “TONE” shows in display, along with the tone value. Use product buttons  set the tone from 50 to 2000 Hz.
6. Press X to exit Alert Tone Mode.



4-5. FILTER AFTER

The number of cook cycles between filtering the oil can easily be programmed for all products.

1. Press and hold  and  buttons until LEVEL - 2 shows in the display, followed by ENTER CODE.
2. Enter code 1, 2, 3, 4 (first 4 product buttons). “PROD” and “COMP” show in the displays.
3. Press ▼ button 4 times and “FILR AFTR” shows in left display.
4. Use the product buttons  to set the number to cook cycles between filtering procedures from 0 to 99.
5. Once set, press √ button to confirm.

4-6. FILTER TIME

The length of time the fryer remains idle between cook cycles before the controls suggest filtering.

1. Press and hold  and  buttons until LEVEL - 2 shows in the display, followed by ENTER CODE.
2. Enter code 1, 2, 3, 4 (first 4 product buttons). “PROD” and “COMP” show in the displays.
3. Press ▼ button 5 times and “FILR TIME” shows in left display.
4. Use the product buttons  to set a time between cook cycles from 0 to 18:00 hours.



For example, if “5:00” is programmed in the right display, if the vat was not used for 5 hours after a cook cycle, the controls would display “FILR NOW?” “YES NO”.

SECTION 5. LEVEL 3 PROGRAMMING





Used to access the following:

- TECH RESETS-Reset Recovery Faults/Passwords to defaults
- SPCL PROG-Program filter control parameters and other items
- CLOCK SET-Set the time-of-day clock / calendar
- DATA COMM-Data Communications, LonWorks, MMC, etc
- HEAT CTRL-Program heat algorithm control parameters
- TECH MODE-Control of outputs, display & button tests, etc.
- STATS MODE-Review, reset operating stats, diagnostic logs, etc

5-1. ADDITIONAL ADVANCED PRODUCT SETTINGS

1. Press and hold  and  buttons until LEVEL - 3 shows in the display, followed by ENTER CODE.
2. Enter code 1, 1, 2, 2, 1, 1, 2, 2 (first 2 product buttons), and “A. TECH” & “RESETS” show in the displays.

>Tech Resets<

3. Press right  button and “RECOVERY FAULTS” shows in the left display. The right display shows “CLR” and the number of recovery error recorded. Press  button to reset the number to “0”.
4. Press  button and “ALL PASSWRDS RESET” shows in the left display. Press  button to reset all the passwords set in the controls.

NOTICE

- Use  button to go back to previous menu items.
- Press X button when finished with the current item, to return to the main menu.
- Press X button a second time to exit Level 3 programming.

5-2. SPECIAL PROGRAMMING

The Special Program Mode is used to set more detailed programming, such as:

- SP-1** • ZONE - USA or Non-USA (default setpoints)
- SP-2** • System Initialization
- SP-3** • 2nd Language: English, French, Candian-French, German, Spanish, Portuguese, Swedish, Russian, & NONE
- SP-4** • 2nd Audio Volume
- SP-5** • Quick Configuration - CHKN+FSH; FF/HBR; CHKN; EMPTY
- SP-6** • Polish Duration - X:XX M:SS
- SP-7** • Drain Valve - NORMAL or MANUAL
- SP-8** • Edit S/N (Serial Number)
- SP-9** • Decal Layout? - UP/DOWN or DOWN/UP
- SP-10** • Recovery Test Limit - XXX SEC
- SP-11** • Melt Cycle Select - 1.LIQUID; 2.SOLID
- SP-12** • 'Change Pad' Reminder Time - XX HRS
- SP-13** • Pan Out = Changed Pad Time - XXX SEC
- SP-14** • Auto-Fill Enabled? - YES; NO
- SP-15** • Auto-Fill Cycle Time? - XXX SEC
- SP-16** • Auto-Fill Check JIB - XXX CNT
- SP-17** • Oil Full If Delta Above... - XX°F or C
- SP-18** • Oil Low If Delta Below... - XX°F or C
- SP-19** • Heat Allowed During Fill? - HEAT OK; NO HEAT
- SP-20** • Always Ask "IS POT FILLED"? - YES; NO
- SP-21** • Oil Drain Time - XXX SEC
- SP-22** • Oil WashTime - XXX SEC
- SP-23** • Oil Rinse Time - XXX SEC
- SP-24** • Oil Typ Fill Time - XXX SEC
- SP-25** • Repeat Fill Time - XXX SEC
- SP-26** • RTD Air Cooling - X.XX°/SC
- SP-27** • RTD Cold Oil Surround - X.XX°/SC
- SP-28** • RTD Hot Oil Surround - X.XX°/SC
- SP-29** • Tmp Probe 'x Above Min' - XXX °F or C
- SP-30** • x Above Min. Hit Limit - XXX CNT
- SP-31** • Level RTD Air Cooling - X.XX°/SC
- SP-32** • Level RTD Oil Surround - X.XX°/SC
- SP-33** • New Pad-Max. Fill Time - XXX SEC
- SP-34** • Old Pad-Max. Fill Time - XXX SEC
- SP-35** • Fill To Top Time - XXX SEC
- SP-36** • Reach Top Plus x Seconds - XXX SEC
- SP-37** • Fill Until Pan Empty - XXX SEC
- SP-38** • Valve Auto - Cycle Period - X:XX H:MM
- SP-39** • Refill Detect By.... - LVL PRBS or PRESSURE
- SP-40** • Min. Wash PSI - XX.XX PSI



5-2. SPECIAL PROGRAMMING
(Continued)

- SP-41** • Max. Bubble PSI - XX.XX PSI
- SP-42** • New Pad Max. Wash Time - XXXX SEC
- SP-43** • Old Pad Max. Wash Time - XXXX SEC
- SP-44** • Min. Fill Time - XXX SEC
- SP-45** • New Pad Max. Fill Time - XXXX SEC
- SP-46** • Old Pad Max. Fill Time - XXXX SEC
- SP-47** • Required Bubble PSI Hits - XXX CNT
- SP-48** • Pressure Trip Limit - XXX PSI
- SP-49** • Pilot During Filter-PILOT OK or NO PILOT (GAS FRYERS ONLY)
- SP-50** • Filling - Low Heat On - XXX SEC
- SP-51** • Filling - Low Heat Off - XXX SEC
- SP-52** • Heat Error Enabled? - YES or NO
- SP-53** • Warm Return Line Enabled?/Interval - H:MM
(Hours/Minutes - OFF to 4 hours)
- SP-54** • Warm Return Line Time - M:SS
(Minutes/Seconds - 0:00 to 4 Minutes)
- SP-55** • Enable R&D Displays? - YES or NO

NOTICE

Not all Special Program Mode functions are discussed in this section. To ensure proper operation of fryer, please consult Henny Penny Corp. before changing any of these settings. For information on these functions, contact the Service Department at 1-800-417- 8405, or 1-937-456-8405.

To Enter Special Programming:

1. Press and hold  and  buttons until LEVEL - 3 shows in the display, followed by ENTER CODE.
2. Enter code 1, 1, 2, 2, 1, 1, 2, 2 (first 2 product buttons).
3. “A. TECH” & “RESETS” show in displays. Press ▼ and “B. SPCL” & “PROG” show in the displays.

Zone - USA/Non-USA (SP-1)

4. Press √ button and “SP-1 ZONE” shows in the left display. Use ◀ and ▶ buttons to set the default set-points to USA specifications or non-USA specifications.

Initialize System (SP-2)

5. Press ▼ button and “SP-2 DO SYSTEM INIT” scrolls in left display. To reset the controls to factory default settings, press and hold √ button and controls count down “IN 3”, “IN 2”, “IN 1”. Once display shows “-INIT-” & *DONE* the controls are reset to factory defaults.

5-2. SPECIAL PROGRAMMING
(Continued)

2nd Language (SP-3)

6. Press ▼ button and “SP-3 2ND LANGUAGE” scrolls in left display. Use ◀ and ▶ buttons to set to: ENGLISH; FRANCAIS; CAN FREN; ESPANOL; PORTUG; DEUTSHE; SVENSKA; РУССКИЙ or -NONE-.

By setting a second language in the controls, 2 languages can now be easlily chosen by pressing  button twice during normal operation.

One language shows in left display and a second language shows in the right display. Pressing the √ button selects the language in the displays.

2nd Volume (SP-4)

7. Press ▼ button; “SP-4” and “2ND VOLUME” flash on the left display. Press the ◀ or ▶ buttons to select the desired 2nd volume.

By setting a 2nd volume in controls, 2 volumes can now be easlily chosen by pressing  button 3 times during normal operation.

One volume setting shows in the left display (NONE to 10; 10 being the loudest) and the second volume shows in the right display. To select the volume, press the √ button under the desired volume .

Quick Configuration (SP-5)

8. Press ▼ button and “SP-5 QUICK CONFIG” shows in display. Use the ◀ and ▶ buttons to change the menu selection in the controls to: CHKN+FSH; FF/HBR;CHKN or EMPTY.

Polish Duration (SP-6)

9. Press ▼ button and “SP-6 POLISH” shows in left display. Use product buttons  to change polish time, from 5 minutes to a maximum of 10 minutes.

Drain Valve (SP-7)

10. Press ▼ button and “SP-7 DRAIN VALVE” scrolls in left display. Use the ◀ and ▶ buttons to change right display to show “NORMAL” or “MANUAL”.

NORMAL means the drain valves are controlled electronic-ally and MANUAL means the drain valves must be opened by hand.



5-2. SPECIAL PROGRAMMING
(Continued)

Edit Unit Serial Number (SP-8)

11. Press ▼ button and “SP-8 S/N √ EDIT” shows in left display. Press the right √ button to enter the unit’s serial number in the controls, using the product buttons.

“STD” and “CUST” show in the right displays. Press the √ button under the “STD” and the first 2 letters of the serial number is the standard equipment code, press the X button and a custom equipment code can be entered. THIS SERIAL NUMBER SHOULD MATCH THE SERIAL NUMBER ON THE DATA PLATE, ON THE DOOR.

Decal Layout (SP-9)

12. Press ▼ button and “SP-9 DECAL LAYOUT?” scrolls in the left display. The words in the right displays should match the arrow type above the  and  buttons.

EX: If the control decal shows ▼ ▲ , the right displays should show DOWN-UP.

If the displays show UP-DOWN, use the ◀ and ▶ buttons to change the displays to DOWN-UP.

Liquid or Solid Cooking Oil Used (SP-11)

13. Press ▼ button and “SP-11 MELT CYCLE SELECT” scrolls in the left display. Unless solid oil is being used in the vats the right display should show “1.LIQUID”.

If solid oil is used, the unit MUST BE equipped to handle solid oil. Use the ◀ and ▶ buttons to change the right display to “2.SOLID”

Change Pad Reminder Time (SP-12)

14. Press ▼ button and “SP-12 ‘CHANGE PAD’ REMINDER” shows on the display. Use the product buttons



to change the time between changing the filter pad reminders.

For example, if “25 HRS” is programmed in the right display, every 25 hours the display shows “CHANGE PAD” as a reminder to the operator that the filter pad needs changed.

Pan Out of Fryer = Pad Changed (SP-13)

15. Press ▼ button and “SP-13 PAN OUT = CHANGED PAD” scrolls in the left display. Use the product buttons



to program the amount of time the drain pan is pulled-out from under the fryer before the controls reset the change pad reminder. This is the amount of time it should take to change filter pad. Range is 15 to 255 seconds.

For example, if “120 SEC” is programmed in the right display, when the drain pan is out from under the fryer for at least 120 seconds, the controls restarts counting for the change pad reminder.





5-2. SPECIAL PROGRAMMING
(Continued)

Auto-Fill Enabled (SP-14)(automatically keeps oil at proper level)

16. Press ▼ button and “SP-14 AUTO-FILL ENABLED?” scrolls in the left display. Use the ◀ and ▶ buttons to set the right display to “YES” or “NO”.

This should always be set to “YES”, unless a hardware failure causes a problem, such as a JIB pump or Add Oil valve failure.

5-3. CLOCK SET

1. Press and hold  and  buttons until LEVEL - 3 shows in the display, followed by ENTER CODE.
2. Enter code 1, 1, 2, 2, 1, 1, 2, 2 (first 2 product buttons).
3. “A. TECH” & “RESETS” show in the displays. Press ▼ button twice and “C. CLOCK” and “SET” show in the displays.
4. Press √ button and “CS-1 ENTER DATE MM-DD-YY” shows in the left display. Use the product buttons  to set the date in the right display.
5. Press ▼ button and “CS-2 ENTER TIME” shows in the left display and the time flashes in the right display. Use the product buttons  to change the time.
6. Press ▼ button and “CS-2 ENTER TIME” shows in the left display and “AM” or “PM” flashes in the right display. Use the ◀ ▶ buttons to change from AM to PM or vice-versa.
7. Press ▼ button and “CS-3 TIME FORMAT” shows in left display and “12-HR” or “24-HR” shows in the right display. Use the ◀ ▶ buttons to change from a 12 hour time format a 24 hour time format or vice-versa.
8. Press ▼ button and “CS-4 DAYLIGHT SAVING TIME” shows in the left display. Use the ◀ ▶ right display to daylight saving time for your area: 1.OFF; 2.US (2007 & after); 3.EURO; or 4.FSA (US before 2007)

5-4. DATA COMM & HEAT CONTROL



Data communications and heat controls settings are shown in Level 3 Program Mode. But, to ensure proper operation of fryer, please consult Henny Penny Corp. before changing any of these settings. For more information on these functions, contact Service Department at 1-800-417- 8405, or 1-937-456-8405.

5-5. TECH MODE



The TECH Mode has self-diagnostic information, which can be used by certified technicians for troubleshooting purposes, such as:

- T-1** • Software
- T-2** • Fryer Type (Split or Full/Gas or Elec.)
- T-3** • Push-Button Test
- T-4** • All-On Display Test
- T-5** • Display Segments Test
- T-6** • Display Digits Test
- T-7** • Display Decimal Points Test
- T-8** • LED's Test
- T-9** • Left Temp. Probe Calibration & Offset
- T-10** • Left Level 1 Probe Calibration & Offset
- T-11** • Left Level 2 Probe Calibration & Offset
- T-12** • Right Temp. Probe Calibration & Offset
- T-13** • Right Level 1 Probe Calibration & Offset
- T-14** • Right Level 2 Probe Calibration & Offset
- T-15** • CPU Control Temp. Calibration/Offset/Highest
- T-16** • View A - D Channel
- T-17** • Digital Inputs
- T-18** • AIF Info
- T-19** • Outputs Test
- T-20** • Pumps & Valves Test
- T-21** • Change Tech Code?
- T-22** • Total Initialization

NOTICE

Not all Tech Mode functions are discussed in this section. To ensure proper operation of fryer, please consult Henny Penny Corp. before changing any of these settings. For more information on these functions, contact Service Department at 1-800-417-8405, or 1-937-456-8405.



5-5. TECH MODE (Continued)

1. To enter the TECH Mode, press and hold  and  buttons for 5 seconds, until display shows "LEVEL 3", followed by "ENTER CODE".
2. Enter code 1, 1, 2, 2, 1, 1, 2, 2 (first 2 product buttons). "A. TECH" & "RESETS" show in the displays.
3. Press ▼ 5 times, and when display shows "F. TECH", press right √ button and T-1 "SOFTWARE" shows in the display, the first step of the TECH Mode. Use ▼ and ▲ buttons to toggle through the steps.

NOTICE

Press the right X button twice, at anytime to return to normal operation.

T-1 - SOFTWARE

- Press  to view HP Part No. of eprom
- Press  to view software ID
- Press  to view software version

T-2 - FRYER TYPE - SPLIT VAT OR FULL VAT/GAS or ELEC

T-3 - PUSH-BUTTON TEST

Press any of the control buttons to test operation. You should hear a beep, and the LED should light and/or a display.

T-4 - ALL-ON DISPLAY TEST

Press any of the product buttons and all the LEDs and display segments should light.

T-5 - SEGMENTS TEST

Press any of the product buttons to view a different segment of the display characters.

T-6 - DIGITS TEST

Press any of the product buttons numerous times to view all segments of each digit across the displays.

T-7 - DECIMAL PTS TEST

Press any of the product buttons numerous times to view all decimal points across the displays.

5-5. TECH MODE (Continued)

T-8 - LED'S TEST

Press any of the product buttons numerous times to view each LED across the control panel.

T-17 - INPUTS - HDE

H = HIGH LIMIT - If "H" is present, the high limit is good. If "-" shows then the high limit is tripped out (overheated) or disconnected.

D = DRAIN SWITCH - If "D" is present, the drain handle (when applicable) is closed. If "-" shows then the drain is open or the switch is faulty.

E = ELEMENT SWITCH - If "E" is present, the element switch is good. If "-" shows in the display, the element is in the upright position, or the switch is faulty.

Press  button and an underscore ("_") indicates the input is not presently detected. A Checkmark ("√") indicates the signal is detecting a normal input. A blinking ("X") indicates the signal is presently detected, but is detected as a half-wave (partially failed) input.

NOTICE

The H, D, E signals above are wired in series. The first signal missing out of this sequence, generally causes all signals to the right of it to be missing as well.

T-18 - AIF INFO

An "AIF √ √ 7" means normal communications between the AIF PCB and the control PCB and software is version 7. "AIF X" means a problem with the communications between the PCBs.

Press  button and "FILR IN" and "USE BY 1(ex)" shows in the displays. These displays shows which controls are using the filtering system.

"USE BY 0" = not in use

"USE BY 7" = used by AIF

"USE BY 1 to 5" = used by control PCB

Press  button and "CPU POSN" and "1 OF 3(ex)" shows in the displays. These displays shows which controls are plugged into which port on the AIF board.

For example, the left control should be plugged into port 1, and on a 3 control fryer, shows "1 OF 3" on the display.

5-5. TECH MODE (Continued)

T-18 - AIF INFO (Continued)

If the right control is unplugged, then the left control would show “1 OF 2” instead of “1 OF 3”.

Press ▼ button and “INP E_P_” & “JL_R_DT_” shows in displays.

AIF Board Inputs:

E = Stop button	E* = E-Stop pressed.
P = Drain Pan	M* = drain pan is missing.
JL = JIB	J* = JIB oil level is low.
R = RTI	R* = RTI System Detected
DT = RTI Discard Tank	DT* = tank full

Press ▼ button and “OUT F_J_” and “N_DI_oJF_” shows in the displays.

AIF Board Outputs:

Current outputs status from AIF board.

F = Filter Pump.	(F* = Filter pump is on)
J = JIB Pump.	(J* = JIB pump is on)
N = New Oil Pump.	(N* = RTI new oil pump on)
DI = Discard Valve.	(DIo = RTI disc. valve open/DIc=closed)
JF = JIB Fill Valve.	(JFo = RTI JIB fill valve open/ JFc=closed)

T-19 - OUTPUTS

S = SAFETY CONTACTOR - Press  to turn off and on the safety (primary) contactor

H = HEAT CONTACTOR - Press  to turn off and on the heat contactor.

T-20 - PUMPS & VALVES

Press √ button and “VALVES” “DcRc” shows in displays.

Press  to open and close the drain valves.

Press  to open and close the return valves.

“DcRc” means valves are closed, “DoRo” means valves are open. (Driven by the control board)

Press ▼ button and “DISCARDc” and “JIBFILLc” shows in the displays. (Driven by the AIF board)

5-5. TECH MODE (Continued)



T-20 - PUMPS & VALVES (Continued)

Press  to open and close the RTI discard valve (display shows “DISCARDo” when open)



Press  to open and close the RTI JIB fill valve (display shows “JIBFILLo” when open)





Press  and “SEL-VALV” “AT HOME” shows in the displays.

Press  button and “REV, CNT” “HOM, POS” followed by actual data values such as “3.19R 10P” “14.4° 15.2°”. One revolution of the valve took 3.19 seconds, counted 10 ports during the revolution, the dwell angle of the home switch was 14.4°, and the dwell angle of the position switch was 15.2°.

Press  button and “CALIBRAT” “AT HOME” show in the displays. Press  button to request a calibration, data values as above will appear in the displays.

Press  button and “NEXT POS” “AT HOME” show in the displays. Press left  button and valve moves to next port position.

Press  button and “CONT RUN” “AT HOME” show in the displays. Press left  button and valve will run continuously until you press the STOP button.

Press  button and “RAW  MTR_” “D  Hx P*” shows in the displays. The  indicates a signal was constantly “ON”, the “_” means a signal was constantly “OFF”, and the “X” means the signal was both “ON” and “OFF”.

Press  button and “PUMP FP_” and “JP_ NP_” shows in the displays. (Driven by the AIF board)

Press  to turn off and on the filter pump (display shows “FP*” when on)

Press  to turn off and on the JIB pump (display shows “JP*” when on)

Press  to turn off and on the RTI new oil pump (display shows “NP*” when on)

Press  button and “LIGHTS” and “FLT_ JLO_” shows in the displays. (Driven by the AIF board)

5-5. TECH MODE (Continued)



T-20 - PUMPS & VALVES (Continued)

Press  to turn off and on the FILTER light (display shows “FLT*” when on)

Press  to turn off and on the JIB LOW light (display shows “JLO*” when on)

5-6. STATS MODE

This mode allows a technician to view advanced information on the operation of the fryer and controls.

1. To enter the TECH Mode, press and hold  and  buttons for 5 seconds, until display shows ”LEVEL 3”, followed by “ENTER CODE”.
2. Enter code 1, 1, 2, 2, 1, 1, 2, 2 (first 2 product buttons). “A. TECH” & “RESETS” show in the displays.
3. Press ▼ 6 times, and when display shows “G. STATS”, press right √ button and “ST-1 LAST RESET ON...” shows in the display, first step of the TECH Mode. Use ▼ and ▲ buttons to toggle through the steps.

- ST-1** • Stats Last Reset Date
- ST-2** • Fryer Total Running Hours
- ST-3** • Left Vat Melt Cycle Hours
- ST-4** • Left Vat Cook Cycle Hours
- ST-5** • Left Vat Filter Lockout Hours
- ST-6** • Right Vat Melt Cycle Hours
- ST-7** • Right Vat Cook Cycle Hours
- ST-8** • Right Vat Filter Lockout Hours
- ST-9** • Power-Ups Count
- ST-10** • Errors Count
- ST-11** • Left Vat Heat On Hours
- ST-12** • Right Vat Heat On Hours
- ST-13** • Highest Left Vat Oil Temperature
- ST-14** • Highest Right Vat Oil Temperature
- ST-15** • Highest CPU Temperature
- ST-16** • System RAM Fade Count
- ST-17** • Cook RAM Fade Count
- ST-18** • Product RAM Fade Count
- ST-19** • Stat RAM Fade Count
- ST-20** • RAM Data Error Count
- ST-21** • Data Total Loss Count
- ST-22** • User Intializations Count
- ST-23** • Automatic Initializations Count
- ST-24** • Cook Counts per Product
- ST-25** • Cook Cycle Stop Counts
 - “A” = no. of stops in 1st 30 sec.; - “B” = 0; - “C” = 0;
 - “D” = complete cook cycles counted
- ST-26** • Reset All Stats

SECTION 6. INFORMATION MODE

6-1. INFO MODE

This mode gathers and stores historic information on fryer and operator's performance. Press and hold  for 3 seconds, until *INFO* *MODE**" shows on the displays.

Press ▼ or ▲ buttons to access steps and press √ button to view the statistics within each step.

This mode includes the following information:

1. **FILTER STATS** - filtering information for the last 7 days
2. **REVIEW USAGE**- information accumulated since the last time this data was manually reset
3. **LAST LOAD** - information about the most recent Cook Cycle, or the cycle presently in progress

NOTICE

Press X button to exit from the Information Mode.

1. **FILTER STATS**

Press √ button to select Filter Stats and press ◀ and ▶ to select day you want to view stats. Then press ▼ or ▲ buttons to view the following stats:

- "FILTERED" = No. of times filtered
- "FLT BPSD" = No. of times filtering was skipped
- "FLT AVG" = Average no. of cook cycles between filters

2. **REVIEW USAGE**

Press √ button to select Review Usage and press ▼ or ▲ buttons to view the following:

FUNCTION	DISPLAY EX:
Day usage data was previously reset	SINCE 9:32P 05-19-10
Total number of cook cycles	TOTAL COOKS 462
Cook Cycles stopped before "PULL"	QUIT COOK 4
Number of hours fryer was on (left)	L ON HRS 165
Number of hours fryer was on (right)	R ON HRS 160
Reset Usage Data	RESET USAGE YES/NO

6-1. INFO MODE
(Continued)

3. LAST LOAD

Press √ button to select Last Load (ex: -P1- = Product 1; "L1" = left, 1st product) and press ▼ or ▲ buttons to view the following:

FUNCTION	DISPLAY EX:
Product (Last product cooked)	PRODUCT -P1- L1
Time of day last Cook Cycle was started	STARTED 10.25A SEP-08
Actual Elapsed cook Time (Real seconds)	ACTUAL TIME 7:38
Programmed cook Time	PROG TIME 3:00
Max Temp during Cook Cycle	MAX TEMP 327°F
Min Temp during Cook Cycle	MIN TEMP 313°F
Avg Temp during Cook Cycle	AVG TEMP 322°F
Heat On (percentage) during Cook Cycle	HEAT ON 73%
Ready? (Was fryer Ready before start?)	READY? YES

SECTION 7. MAINTENANCE

7-1. INTRODUCTION

This section provides checkout and replacement procedures, for various parts of fryer. Before replacing any parts, refer to Troubleshooting Section to aid you in finding the cause of the malfunction.

7-2. MAINTENANCE HINTS

1. A multimeter will help you to check electric components.
2. When the manual refers to the circuit being closed, the multimeter should read zero unless otherwise noted.
3. When the manual refers to a circuit being open, multimeter should read infinity.



Do not move the fryer with hot oil in the vat or filter pan. Severe burns can result from splashing hot oil.

7-3. PREVENTIVE MAINTENANCE

To ensure a long life of fryers and their components, regular maintenance should be performed. Refer to the chart below.

Frequency	Action
Daily	Maintenance Filter (See Maintenance Filtering Instructions Section in Operator's Manual or PM Guide)
Daily	Change Filter Pad (See Changing Filter Pad Section in Operator's Manual or PM Guide)
Weekly	Clean Behind Fryer (See PM Guide)
Quarterly	Change Filter Pan O-Rings (See PM Guide)
Quarterly	Vat Deep Clean (See Deep Clean Mode Section in Operator's Manual or PM Guide)

7-4. CONTROL PANEL & MENU CARD REPLACEMENT

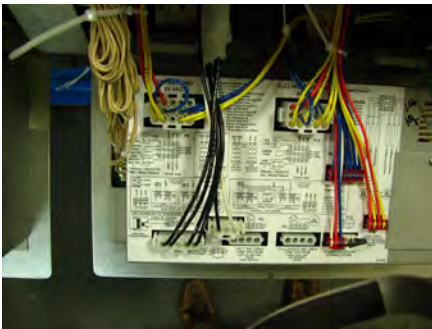

Should the control panel become inoperative, or the menu card needs changed, follow these instructions:

Control Panel Replacement

1. Remove electrical power supplied to the vat.



To avoid electrical shock or property damage, move the power switch to OFF and disconnect main circuit breaker, or unplug cord at wall receptacle.

2. Support control panel with one hand, loosen retaining screw at panel top, slide panel down enough to clear screw, push panel back up, then swing panel top out and down.
3. Unplug connectors on back of control panel.
4. Support control panel bottom with one hand, swing panel top up about 90 degrees, let panel slide down until hinge tabs come out of shroud slots, and remove panel.
5. Install new control panel by inserting hinge tabs in slots.
6. Plug connectors into back of control panel per label on panel or refer to diagram on page 7-29.
7. Support control panel bottom, swing panel top up about 90 degrees, slide panel down slightly to clear screw head, push panel top up to engage screw, then tighten screw.
8. Connect power and check operation of unit

Menu Card Replacement

1. Perform steps 1 and 2 above.
2. Loosen tape securing card at right side of control panel and pull card from panel. Carefully slide new menu card back into panel slot and secure with tape.
3. Perform steps 7 and 8 above.



7-5. HIGH TEMPERATURE LIMIT SYSTEM

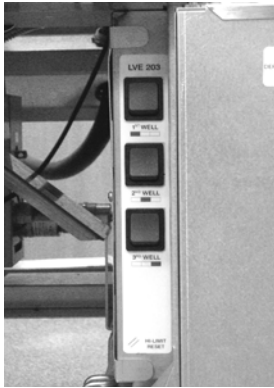

A thermocouple is attached to each element and senses oil temperature. If temperature exceeds 425°F (218°C), a switch opens and shuts off heat to vat, and an E-10 error code is displayed. After oil temperature cools to a safe operating temperature (15-20 min.), high limit control must be manually reset.

Reset switches are located in the front edge of an electrical panel on the right side of the unit beside the JIB. Open the right door, depress the raised part of the rocker switch for the affected well, and release switch. If high limit resets, the oil starts heating. If high limit does not reset, perform following checkout procedure.

Checkout:



To avoid electrical shock or property damage, move power switch to OFF and disconnect main circuit breaker, or unplug cord at wall receptacle.

1. Open right door and remove the JIB.
2. Remove 1 screw and panel cover.
3. Locate thermocouple wires from element and disconnect from high limit.
4. Using a multimeter and the chart on the next page, check the milivolt reading between the thermocouple wires and compare with the chart of the J-Type thermocouple. If the reading matches the chart, the thermocouple on the element is good and continue onto step 5 of the checkout. If not, go to section 7-6 on replacing the element.

**7-5. HIGH TEMPERATURE
LIMIT SYSTEM**

Checkout: (Continued)

J°F

Table 8. Type J Thermocouple -- thermoelectric voltage as a function of temperature (°F); reference junctions at 32°F

°F	0	1	2	3	4	5	6	7	8	9	0	°F
Thermoelectric Voltage in Millivolts												
50	0.507	0.535	0.563	0.592	0.620	0.649	0.677	0.705	0.734	0.762	0.791	50
60	0.791	0.819	0.848	0.876	0.905	0.933	0.962	0.991	1.019	1.048	1.076	60
70	1.076	1.105	1.134	1.162	1.191	1.220	1.249	1.277	1.306	1.335	1.364	70
80	1.364	1.392	1.421	1.450	1.479	1.508	1.537	1.566	1.594	1.623	1.652	80
90	1.652	1.681	1.710	1.739	1.768	1.797	1.826	1.855	1.884	1.913	1.942	90
100	1.942	1.972	2.001	2.030	2.059	2.088	2.117	2.146	2.175	2.205	2.234	100
110	2.234	2.263	2.292	2.322	2.351	2.380	2.409	2.439	2.468	2.497	2.527	110
120	2.527	2.556	2.585	2.615	2.644	2.673	2.703	2.732	2.762	2.791	2.821	120
130	2.821	2.850	2.880	2.909	2.938	2.968	2.997	3.027	3.057	3.086	3.116	130
140	3.116	3.145	3.175	3.204	3.234	3.264	3.293	3.323	3.353	3.382	3.412	140
150	3.412	3.442	3.471	3.501	3.531	3.560	3.590	3.620	3.650	3.679	3.709	150
160	3.709	3.739	3.769	3.798	3.828	3.858	3.888	3.918	3.948	3.977	4.007	160
170	4.007	4.037	4.067	4.097	4.127	4.157	4.187	4.217	4.246	4.276	4.306	170
180	4.306	4.336	4.366	4.396	4.426	4.456	4.486	4.516	4.546	4.576	4.606	180
190	4.606	4.636	4.666	4.696	4.726	4.757	4.787	4.817	4.847	4.877	4.907	190
200	4.907	4.937	4.967	4.997	5.028	5.058	5.088	5.118	5.148	5.178	5.209	200
210	5.209	5.239	5.269	5.299	5.329	5.360	5.390	5.420	5.450	5.480	5.511	210
220	5.511	5.541	5.571	5.602	5.632	5.662	5.692	5.723	5.753	5.783	5.814	220
230	5.814	5.844	5.874	5.905	5.935	5.965	5.996	6.026	6.056	6.087	6.117	230
240	6.117	6.147	6.178	6.208	6.239	6.269	6.299	6.330	6.360	6.391	6.421	240
250	6.421	6.452	6.482	6.512	6.543	6.573	6.604	6.634	6.665	6.695	6.726	250
260	6.726	6.756	6.787	6.817	6.848	6.878	6.909	6.939	6.970	7.000	7.031	260
270	7.031	7.061	7.092	7.122	7.153	7.184	7.214	7.245	7.275	7.306	7.336	270
280	7.336	7.367	7.398	7.428	7.459	7.489	7.520	7.550	7.581	7.612	7.642	280
290	7.642	7.673	7.704	7.734	7.765	7.795	7.826	7.857	7.887	7.918	7.949	290
300	7.949	7.979	8.010	8.041	8.071	8.102	8.133	8.163	8.194	8.225	8.255	300
310	8.255	8.286	8.317	8.347	8.378	8.409	8.439	8.470	8.501	8.532	8.562	310
320	8.562	8.593	8.624	8.654	8.685	8.716	8.747	8.777	8.808	8.839	8.869	320
330	8.869	8.900	8.931	8.962	8.992	9.023	9.054	9.085	9.115	9.146	9.177	330
340	9.177	9.208	9.238	9.269	9.300	9.331	9.362	9.392	9.423	9.454	9.485	340
350	9.485	9.515	9.546	9.577	9.608	9.639	9.669	9.700	9.731	9.762	9.793	350
360	9.793	9.823	9.854	9.885	9.916	9.947	9.977	10.008	10.039	10.070	10.101	360
370	10.101	10.131	10.162	10.193	10.224	10.255	10.285	10.316	10.347	10.378	10.409	370
380	10.409	10.440	10.470	10.501	10.532	10.563	10.594	10.625	10.655	10.686	10.717	380
390	10.717	10.748	10.779	10.810	10.840	10.871	10.902	10.933	10.964	10.995	11.025	390
400	11.025	11.056	11.087	11.118	11.149	11.180	11.211	11.241	11.272	11.303	11.334	400
410	11.334	11.365	11.396	11.426	11.457	11.488	11.519	11.550	11.581	11.612	11.642	410
420	11.642	11.673	11.704	11.735	11.766	11.797	11.828	11.858	11.889	11.920	11.951	420
430	11.951	11.982	12.013	12.044	12.074	12.105	12.136	12.167	12.198	12.229	12.260	430
440	12.260	12.290	12.321	12.352	12.383	12.414	12.445	12.476	12.506	12.537	12.568	440
450	12.568	12.599	12.630	12.661	12.691	12.722	12.753	12.784	12.815	12.846	12.877	450
460	12.877	12.907	12.938	12.969	13.000	13.031	13.062	13.093	13.123	13.154	13.185	460
470	13.185	13.216	13.247	13.278	13.308	13.339	13.370	13.401	13.432	13.463	13.494	470
480	13.494	13.524	13.555	13.586	13.617	13.648	13.679	13.709	13.740	13.771	13.802	480
490	13.802	13.833	13.864	13.894	13.925	13.956	13.987	14.018	14.049	14.079	14.110	490
500	14.110	14.141	14.172	14.203	14.233	14.264	14.295	14.326	14.357	14.388	14.418	500
510	14.418	14.449	14.480	14.511	14.542	14.573	14.603	14.634	14.665	14.696	14.727	510
520	14.727	14.757	14.788	14.819	14.850	14.881	14.911	14.942	14.973	15.004	15.035	520
530	15.035	15.065	15.096	15.127	15.158	15.189	15.219	15.250	15.281	15.312	15.343	530
540	15.343	15.373	15.404	15.435	15.466	15.496	15.527	15.558	15.589	15.620	15.650	540

NOTICE

Oil temperature must be below 380°F (193°C) to perform this check.

5. Connect a known good high limit control into wiring for the suspect thermocouple and control.
6. Connect electrical power and operate vat. If vat does not overheat, replace defective control with known good part.
7. If vat overheats, perform more checkouts of other components (relays, contactors, probes, etc.) and replace the heating element as the last resort.

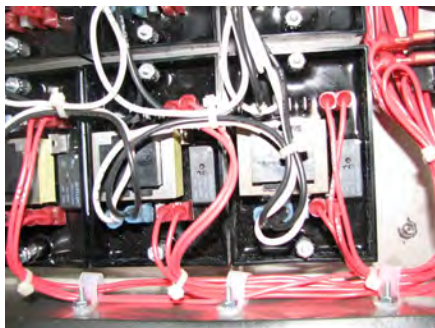

High Limit Controls

Replacement

1. Tag and remove lead wires to module.
2. Using 3/8" socket, remove 2 nuts securing control to panel.
3. Install a new control in reverse order.

7-6. ELECTRIC HEATING ELEMENT

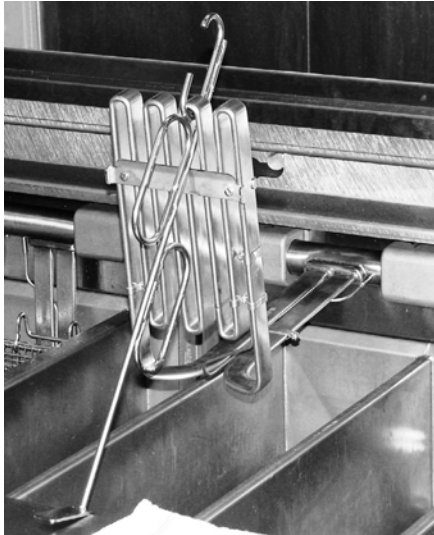

The fryers are equipped with as few as 2 heating elements or as many as 8 elements. If one of the small elements in the middle needs replacement, 1 or 2 of the other elements must also be removed to gain access to the faulty element.

The high temperature limit sensor is an integral part of the heating element. If the sensor requires replacement, the heating element must be replaced.

See element specification chart on page 7-7.

Replacement

1. Drain oil from vat containing faulty element and any adjoining split vats from which heaters must be removed to gain access to defective element.
2. Using lift tool, raise the affected heating elements to assist in replacement of the faulty element and support them using vat lids or piece of lumber



Avoid putting the lift tool in the same area as the high limit bulb, or damage



To avoid electrical shock or property damage, move the power switch to OFF and disconnect main circuit breaker, or unplug cords at wall receptacle.

3. Using Phillip's-head screwdriver, remove 6 screws and rear shroud.
4. Using a 1/2" wrench, remove 8 cap screws and 2 pivot blocks holding faulty



Carefully gather up any slack in the lead wires for the heaters in the adjoining vats at the back of the fryer to minimize the amount of disassembly of the pivot blocks and heaters to keep from disconnecting all the wires but allow the defective heater to be replaced.

5. As needed, repeat previous step to remove any other pivot blocks for adjoining split vats that help hold the faulty heater in place.



7-6. ELECTRIC HEATING
ELEMENT
(Continued)

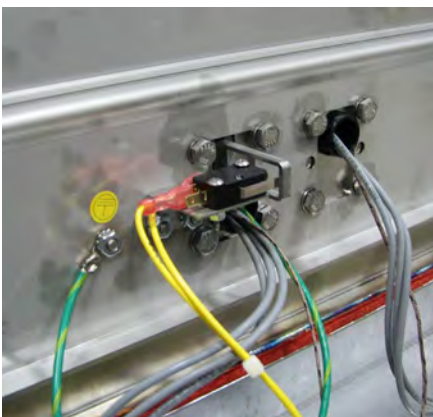
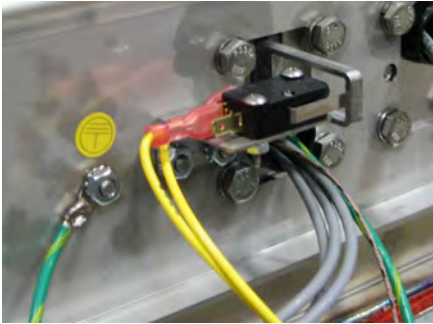

Replacement (continued)

6. Remove element sense switch arm from heater pin and separate heater from pivot blocks.
7. Using 3/8" socket, remove nut and ground wire from stud.
8. Disconnect 3 heater wires from corresponding contactor in controls area behind control panels. Pull 2 leads to rear of fryer. Leave 1 lead in place to pull new leads through.
9. Disconnect 2 sensor wires from high temperature limit control in panel beside JIB. Pull 1 lead to rear of fryer.
10. Record routing of lead wires through pivot blocks and fryer sheet metal for use when installing new element.
11. Cut the 2 leads left in place and pull all remaining lead wires through pivot block. Remove heating element.
12. Inspect and replace defective pivot block seals and O-rings.

Reassembly

1. Position new element between pivot blocks and route lead wires through blocks and sheet metal as recorded earlier.
2. Assemble heater elements, pivot blocks, and switch arms making sure arms fully engage the pins on the elements and that no wire leads are pinched or severely kinked.
3. Working from the center out, install all pivot blocks making sure switch arms are located over switches and secure each block with 4 screws. Tighten screws finger tight only.
4. Tape new thermocouple leads to old lead left in place, route to panel beside JIB, and connect lead wires to high limit control.
5. Tape new power leads to old lead left in place and route to controls area at front of fryer and connect to contactor.
6. Align pivot blocks and heaters straight across front of fryer and snug screws. Lower elements into vats and adjust each so no element rubs side of vat. Make sure wires are clear and element sense switches operate properly.
7. Torque each heater retaining bolt to 70 inch pounds.
8. Connect ground wires, install panel, restore power, and test operation of fryer.

7-6. ELECTRIC HEATING ELEMENT(Continued)

PART#	TOTAL WATTAGE PER VAT	WATTAGE PER HEATER	VOLTAGE	SYSTEM VOLTAGE	SYSTEM WIRING CONFIGURATION	WATTS PER SQ. INCH	ELEMENT RESISTANCE PER ELEMENT (PHASE TO PHASE)	ELEMENT RESISTANCE (PHASE TO NEUTRAL)	COLOR CODE
SPLIT VAT	SPLIT VAT								
84401-001	7000	7000	N/A	208 VAC	3 WIRE WYE	37	11.77	N/A	GREEN
84401-002	7000	7000	230 VAC	400 VAC	4 WIRE WYE	37	N/A	21.59	BLUE
84401-003	7000	7000	277 VAC	480 VAC	4 WIRE WYE	37	N/A	31.32	BLACK
84401-004	7000	7000	N/A	200 VAC	3 WIRE WYE	37	10.88	N/A	LT. BLUE
84401-005	7000	7000	220 VAC	380 VAC	4 WIRE WYE	37	N/A	19.76	YELLOW
84401-006	7000	7000	240 VAC	415 VAC	4 WIRE WYE	37	N/A	23.51	RED
84401-007	7000	7000	N/A	220 VAC	3 WIRE WYE	37	13.18	N/A	BROWN
84401-008	7000	7000	N/A	230 VAC	3 WIRE WYE	37	14.4	N/A	PURPLE
84401-009	7000	7000	N/A	240VAC	3 WIRE WYE	37	15.68	N/A	SILVER
FULL VAT	FULL VAT								
84375-001	14000	7000	N/A	208 VAC	3 WIRE WYE	37	11.77	N/A	GREEN
84375-002	14000	7000	230 VAC	400 VAC	4 WIRE WYE	37	N/A	21.59	BLUE
84375-003	14000	7000	277 VAC	480 VAC	4 WIRE WYE	37	N/A	31.32	BLACK
84375-004	14000	7000	N/A	200 VAC	3 WIRE WYE	37	10.88	N/A	LT. BLUE
84375-005	14000	7000	220 VAC	380 VAC	4 WIRE WYE	37	N/A	19.76	YELLOW
84375-006	14000	7000	240 VAC	415 VAC	4 WIRE WYE	37	N/A	23.51	RED
84375-007	14000	7000	N/A	220 VAC	3 WIRE WYE	37	13.18	N/A	BROWN
84375-008	14000	7000	N/A	230 VAC	3 WIRE WYE	37	14.4	N/A	PURPLE
84375-009	14000	7000	N/A	240VAC	3 WIRE WYE	37	15.68	N/A	SILVER

7-7. BREAKERS

There are two breakers on the electric fryer which protect the filter pump. To reset the breaker, open the left door and push up on the plunger of the tripped breaker.



To avoid electrical shock or property damage, move the power switch to OFF and disconnect main circuit breaker, or unplug cord at wall receptacle.



1. Support control panel bottom with 1 hand, loosen retaining screw at panel top, slide panel down slightly to clear screw, push panel back up, then swing panel top out and down.

Checkout

2. Pull wires from breaker. Using a multimeter or continuity light, check across terminals - circuit should be closed. If not, replace the breaker.

Replacement

3. Open left door.
4. Using a 9/16” wrench, remove retaining nut from below and remove breaker from controls area.
5. Install new breaker in reverse sequence.
6. Support control panel bottom with 1 hand, swing panel top up about 90 degrees, slide panel down slightly to clear screw head, push panel top up to engage screw, then tighten screw.



7-8. MAIN POWER SWITCH

This is a covered rocker switch, which in the ON position, sends power to all the controls and filter motor. However, in some installations, one pair of contacts may be used to control an exhaust hood fan.



To avoid electrical shock or property damage, move the power switch to OFF and disconnect main circuit breaker, or unplug cord at wall receptacle.

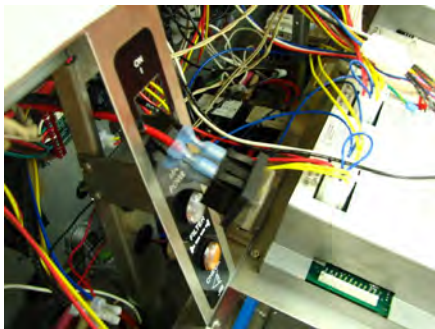

1. Support control panel bottom with 1 hand, loosen retaining screw at panel top, let panel slide down slightly to clear screw, push panel back up, then swing panel top out and down.
2. From inside of control area, squeeze in on tabs on back of switch and push switch out the front of control area.
3. Label and remove wires from switch.

Checkout

4. Check across 2 sets of switch terminals for continuity. With switch in ON position, circuit should be closed. With switch in OFF position, circuit should be open.

If the switch is found to be defective, replace it by connecting the wires to new switch (as labeled) and push switch into place.

7-9. TEMPERATURE PROBE REPLACEMENT

The temperature probe relays the actual shortening temperature to the control. If it becomes disabled, “E-6” will show in the display. Also, if the temperature is out of calibration more than 10°F, or 10°C, the temperature probe should be replaced.

Temp. F	Temp. C	Resistance Ohms	Temp. F	Temp. C	Resistance Ohms
50	10.00	1039.02	250	121.11	1464.79
60	15.56	1060.65	260	126.67	1485.71
70	21.11	1082.24	270	132.22	1506.58
80	26.67	1103.80	280	137.78	1527.43
90	32.22	1125.32	290	143.33	1548.23
100	37.78	1146.81	300	148.89	1569.00
110	43.33	1168.26	310	154.44	1589.73
120	48.89	1189.67	320	160.00	1610.43
130	54.44	1211.05	325	162.78	1620.77
140	60.00	1232.39	330	165.56	1631.09
150	65.56	1253.70	340	171.11	1651.72
160	71.11	1274.97	350	176.67	1672.31
170	76.67	1296.20	360	182.22	1692.86
180	82.22	1317.40	365	185.00	1703.13
185	85.00	1327.99	370	187.78	1713.38
190	87.78	1338.57	380	193.33	1733.87
200	93.33	1359.69	390	198.89	1754.31
210	98.89	1380.79	400	204.44	1774.72
212	100.00	1385.00	410	210.00	1795.10
220	104.44	1401.84	420	215.56	1815.44
230	110.00	1422.86	430	221.11	1835.74
240	115.56	1443.85	440	226.67	1856.01

An Ohm check can be performed also. See chart at left and Checkout instructions on next page.

**7-9. TEMPERATURE PROBE
REPLACEMENT
(Continued)**



Checkout:



To avoid electrical shock or property damage, move the power switch to OFF and disconnect main circuit breaker, or unplug cord at wall receptacle.

1. Support control panel bottom with 1 hand, loosen retaining screw at panel top, slide panel down slightly to clear screw, push panel bottom up, then swing panel top out and down.
2. Disconnect 12-pin connector on left side of control panel.
3. Using multimeter, take ohm reading on appropriate Oil Temp pins. If readings are very different than charts on control panel label or on preceding page, replace probe.

Replacement:

1. Support control panel bottom with 1 hand, swing panel top up about 90 degrees, slide panel down slightly to clear screw head, push panel up to engage screw, and tighten.
2. Restore fryer power, and drain oil from vat.
3. Using a 1/2" wrench, remove nut on compression fitting, and remove temperature probe from vat.
4. Go to front of fryer to control panel for vat with suspect probe, loosen retaining screw with Phillip's head screwdriver and hinge control panel down.
5. Disconnect 12-pin connector at left side of control panel and place connector on flat surface with the open side up.
6. Hold connector in place with one hand, use other hand to insert pocket knife blade or other small sharp tool into connector notch to depress metal locking tab.
7. Continue to hold locking tab down and pull lead wire out of the rear of connector and remove probe from fryer.

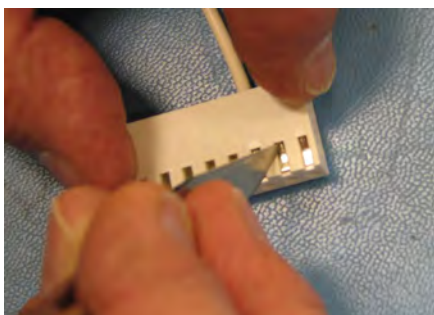

**7-9. TEMPERATURE PROBE
REPLACEMENT
(Continued)**

8. Place nut and new ferrule on new oil level probe and insert probe into compression fitting.
9. Follow probe installation instructions below:

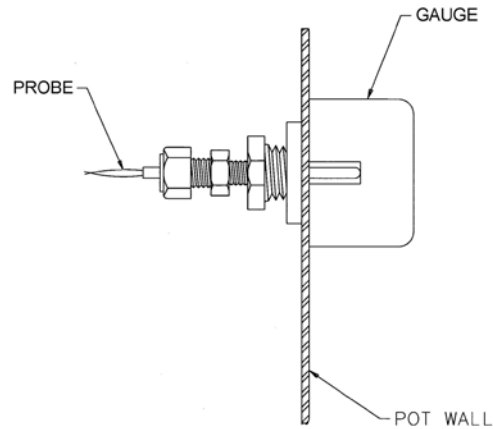

- NOTE:
- 1.) LOCATE TEMPERATURE PROBE THRU POT WALL.
 - 2.) PLACE GAUGE AGAINST POT WALL AS SHOWN.
 - 3.) PUSH TEMPERATURE PROBE THRU UNTIL IT MAKES CONTACT WITH GAUGE.
 - 4.) TIGHTEN TEMPERATURE PROBE IN PLACE.

CAUTION

Excess force will damage temperature probe. Hand-tighten nut and then 1/2 turn with a wrench.

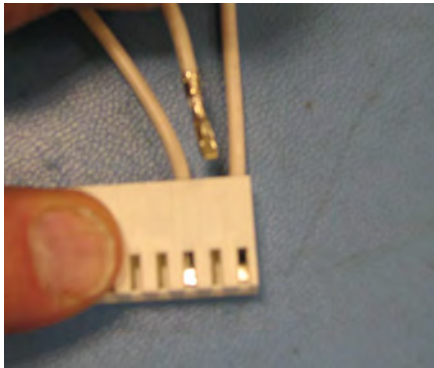

10. With locking tab up, insert pin into connector opening and visually check that tab is fully engaged. Fasten connector to control panel.
11. Support control panel bottom with 1 hand, swing panel top up about 90 degrees, slide panel down slightly to clear screw head, push panel top up to engage screw, then tighten screw.
12. Reconnect power to vat and fill vat with oil.

7-10. ELEMENT SENSE SWITCH

This switch removes power to the element when the element is raised. If a constant “E-31” “HEATING ELEMENTS ARE UP”, is shown on display when elements are lowered into vat, check element safety switch.

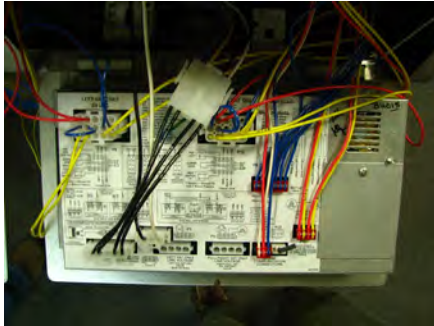

To avoid electrical shock or property damage, move power switch to OFF and disconnect main circuit breaker, or unplug cord at wall receptacle.

Checkout:

1. Support control panel bottom with 1 hand, loosen retaining screw at control panel top, slide panel down slightly to clear screw, push panel up, swing panel top out and down.
2. Refer to decal on control panel back, locate P9 connector (left vat-split vat) or P10 connector (full or right vat).
3. Pull connector from panel and using multimeter, check for continuity between 2 appropriate pins (labeled HEAT SWITCH). With safety switch plunger pushed in (element lowered), circuit should be closed. With element up, circuit should be open. If switch is faulty, replace switch.

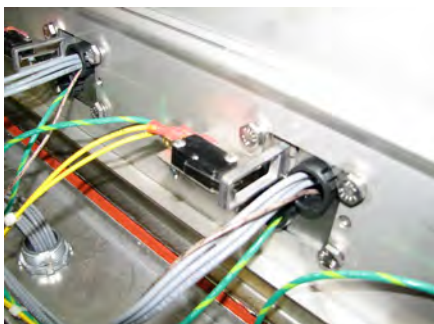

Replacement:

1. Remove 6 screws and rear shroud.
2. Pull the wires from the switch.
3. Use Phillip's-head screwdriver and 5/16" nut driver to remove 2 screws and nuts securing the switch.
4. Reassemble with new switch, making sure switch lever is inside hole of element sense arm and the switch is actuated, and then reconnect wires to the switch.
5. Reinstall rear shroud.
6. Reconnect P9 or P10.
7. Support control panel bottom with 1 hand, swing panel top up about 90 degrees, slide panel down slightly to clear screw, push panel up to engage screw, and tighten screw.

7-11. CONTACTORS

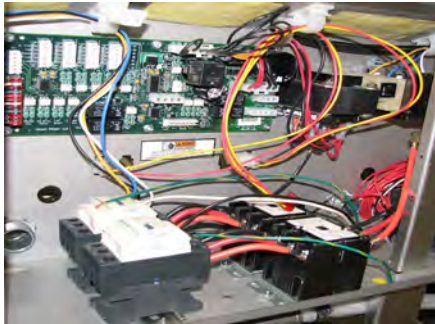

The open fryer requires two switching, 24V contactors per vat: a primary and a heat contactor. The primary contactor energizes (contacts close) any time the main power switch is in the ON position, and the temperature of the shortening is below 420° F (215° C). The high temperature limit module cuts power at the primary contactor if the temperature of the shortening is above 420° F (215° C). The primary contactor supplies power to one side of the heat contactor.

The heat contactor is controlled by the computer controller. When the  button is pressed and the controller calls for heat, the heat contactor applies power to the heating elements. When the heat contactor and primary contactor are energized (contacts closed), electric heating elements heat the shortening.

Checkout

1. Remove electrical power supplied to the fryer.



To avoid electrical shock or property damage, move the power switch to OFF and disconnect main circuit breaker, or unplug cord at wall receptacle.

2. Support control panel bottom with 1 hand, loosen retaining screw at control panel top, slide panel down slightly to clear screw, push panel back up, swing panel top out and down.

CONTACTOR

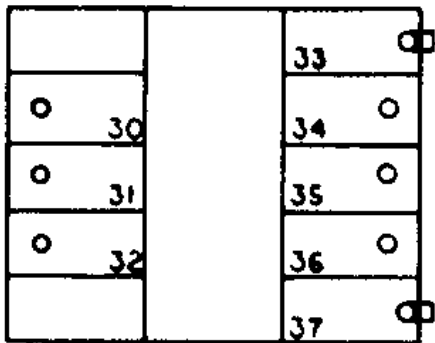

3. Label and remove wires from contactors and perform a check on both contactors as follows:

<u>Test Points</u>	<u>Results</u>
From 30 to 34	open circuit
From 31 to 35	open circuit
From 32 to 36	open circuit
From 33 to 37 (coil)	ohm reading 5 to 6



To avoid electrical shock, make connections before applying power, take reading, and remove power before removing meter leads. The following checks are performed with the wall circuit breaker closed and the main power switch in the ON position.

7-11. CONTACTORS **(Continued)**

4. With power reapplied and in a heat-up mode, check the power going to both contactor coils. Power should be going to both contactors.

If no voltage is found going into the primary contactor coil, check wiring, high limit module, and element switch.

If no voltage at heat contactor coil check wiring and connections at PC board.

Replacement

If either contactor proves defective, replace as follows:



To avoid electrical shock or property damage, move power switch to OFF and disconnect main circuit breaker, or unplug cord at wall receptacle.

1. Label and remove only those wires directly connected to the contactor being replaced.
2. Using a 3/8" wrench or socket, remove 2 mounting nuts on base plate of contactor being replaced and remove contactor.

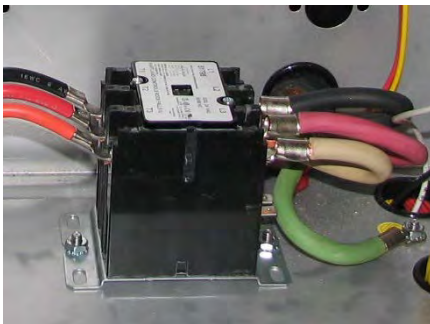

3. When replacing the heat contactor, slide it from the mounting rail.
4. Install new contactor in reverse order.
5. Reconnect power to the fryer and test for proper operation.
6. Support control panel bottom with 1 hand, swing panel top up about 90 degrees, slide panel down slightly to clear screw head, push panel top up to engage screw, then tighten screw.



7-12. SELECTOR VALVE

All vats are plumbed into the selector valve. It controls the flow of oil into and out of each vat. It is a rotary valve operated by a low voltage motor.



To avoid electrical shock or property damage, move the power switch to OFF and disconnect main circuit breaker, or unplug cord at wall receptacle.

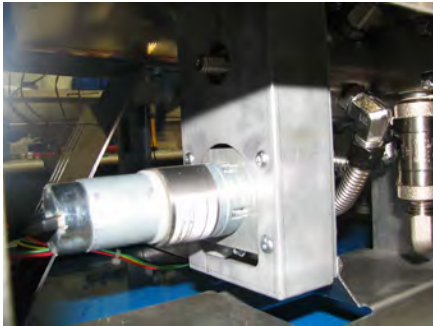

Motor Replacement

1. Using a 1/8" Allen wrench, loosen 2 screws and remove chain guard.
2. Using a 1/8" Allen wrench, remove 4 screws.
3. Pivot rear of motor down while lifting up to disengage motor sprocket from chain.
4. Disconnect motor lead wires at connector.
5. Install new motor assembly in the reverse order. Torque the four screws to 30 in-lbs.

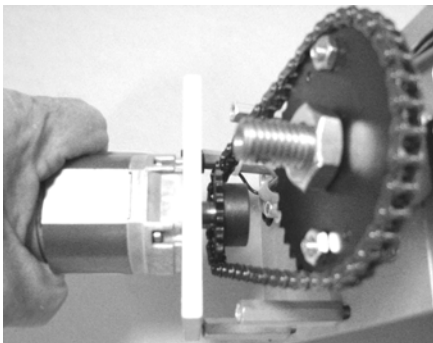
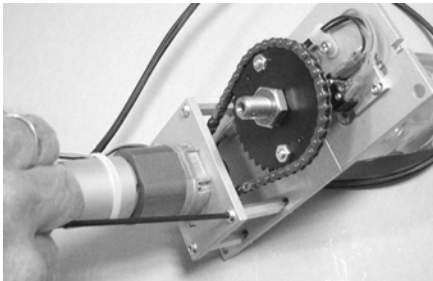

BAD



GOOD

CAUTION

Disassembling the selector valve is not recommended. In the event that the selector valve is disassembled, the gear lever must be correctly installed as shown in the image to the right.

7-12. SELECTOR VALVE (Continued)

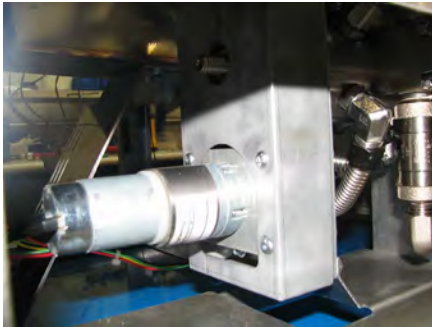

Step 1

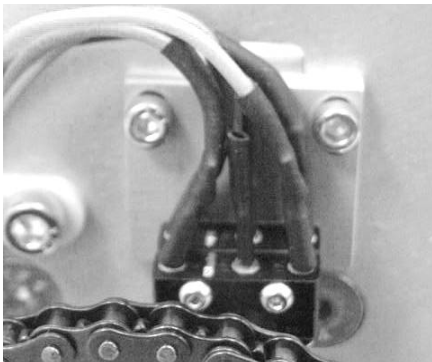

Step 2

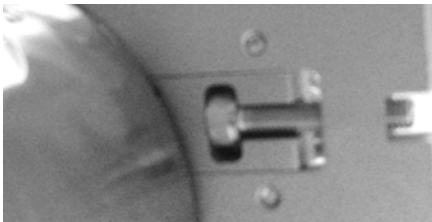

Step 3

Switches Replacement



To avoid electrical shock or property damage, move power switch to OFF and disconnect main circuit breaker, or unplug cord at wall receptacle.

1. Using a 1/8" Allen wrench, loosen 2 screws and remove chain guard.
2. Using a 7/64" Allen wrench, remove 2 screws and switches.
3. Install new switches assembly over adjustment screw head and into the large slot. Align mounting screw holes and install 2 screws finger tight.
4. Lightly push the switches bracket up against the adjustment screw head and hold in place. Tighten mounting screws.
5. Move lead wires from old switches to new switches.



Drive chain and sprockets will begin operating. Keep fingers and hands clear of moving parts or personal injury could result.

6. Move main power switch to ON position; selector valve will perform automatic calibration.
7. Press both Filter buttons at same time for Info mode, press Left Arrow button twice for 13. PUMPS VALVES, press Down Arrow button 3 times for SEL-VALV, press product number button 3 for CALIBRAT, and press √ button.
8. Valve will rotate 2 turns and dwell angles for both switches will show in right display. Values should be between about 12.0 and 18.0. If not, adjust position of switches assembly.
9. Install chain guard and tighten retaining screws.

**7-12. SELECTOR VALVE
(Continued)**

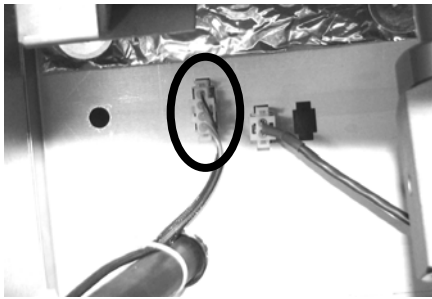

Step 4

Step 3

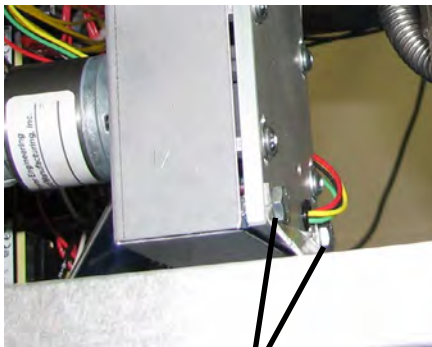

Step 6

Valve Assembly Replacement



To avoid electrical shock or property damage, move power switch to OFF and disconnect main circuit breaker, or unplug cord at wall receptacle.

1. Drain oil from all vats.
2. Disconnect lead wires at connector on rear wall of controls area and push through hole toward back of fryer.
3. Using a 15/16" wrench, disconnect all flexible oil lines from selector valve body fittings.
4. Using a 1" wrench, disconnect hard line from filter pump to elbow.
5. Using a 7/16" wrench, remove 2 mounting bolts from support at end of valve.
6. Using 7/16" wrenches, remove 2 mounting bolts and 2 nuts and selector valve assembly from fryer.
7. Locate elbow and pipe plugs in ports of selector valve. Label corresponding ports in new selector valve, and remove elbow and plugs from the old valve and place into labeled ports in new valve.
8. Assemble in reverse order.

7-13. DRAIN VALVES

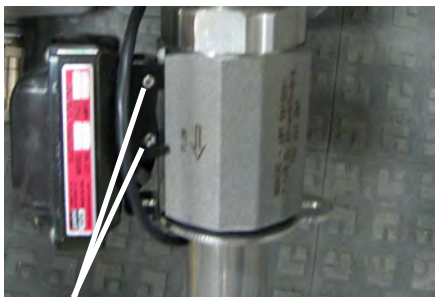
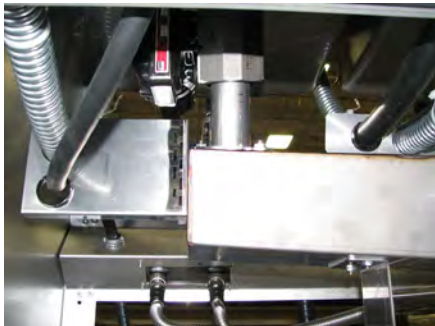
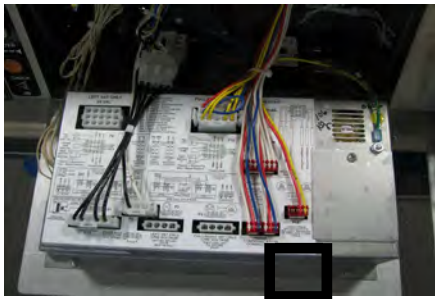

Set Screws

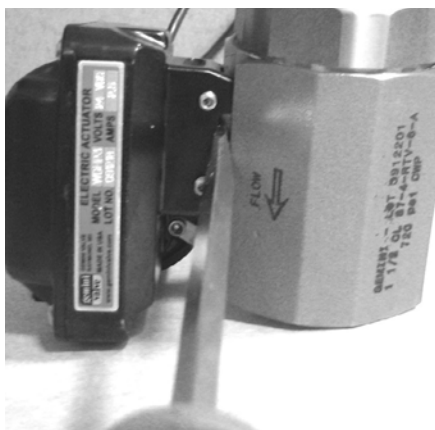

Replacement

Each vat drain valve is opened and closed by an actuator. If oil won't drain or pump back into a vat, the actuator may be faulty.



To avoid electrical shock or property damage, move power switch to OFF and disconnect main circuit breaker, or unplug cord at wall receptacle.

1. Support control panel bottom with 1 hand, loosen retaining screw at top, slide panel down slightly to clear screw, push panel bottom up, then swing panel top out and down.
2. Trace wires from P12 on panel to vertical wall of controls area and separate required connector.
3. From the rear of the fryer and using a 3/8" wrench, remove 2 nuts securing seal clamp to drain trough studs.
4. Grasp drain valve and motor assembly, turn assembly 1/8 turn (45 degrees) counter clockwise (CCW) and slide assembly down so valve inlet clears vat drain tube.
5. Lift clamp up off of drain trough studs and maneuver valve and motor assembly with lower drain tube attached from under the fryer.
6. Remove shims, O-ring and clamp from lower drain tube.
7. Using large slip joint pliers, turn lower drain tube 1/8 turn (45 degrees) CCW and remove tube from valve.
8. Remove O-rings from inlet and outlet sides of valve body.
9. Using a 7/32" Allen wrench, loosen and unscrew 2 set screws until almost removed.
10. Using a flat blade screwdriver, pry motor from valve body.
11. Re-assemble in reverse order. Lubricate all O-rings with cooking oil. Align "nubs" on drain tubes with notches in valve body, push the tube into valve body and turn 1/8 turn (45 degrees) clockwise (CW) to lock position.

7-14. FILTER PUMP & MOTOR



The 2 most common causes for a fryer not to pump oil are that the pump is clogged, or the thermal overload switch has been tripped on the motor. The pump and motor is located behind the middle door above the drain pan.

To remove debris from pump:

1. Loosen four Allen head screws on end of pump and remove cover. (Removing the bottom rear panel may help in accessing the set screws.)
2. The inside is now exposed leaving a rotor and five teflon rollers. Clean the rotor and rollers.
3. To reassemble, place rotor on drive shaft, and place roller into rotor.

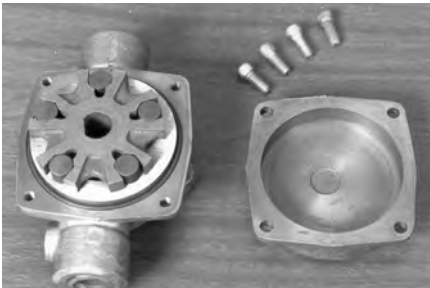

NOTICE

A small amount of grease might be needed to hold the bottom roller into place until cover plate is put on. Make sure O-ring is in proper position on plate.



CAUTION

There is an indicator on the side of the two halves of the pump, this mark must be together

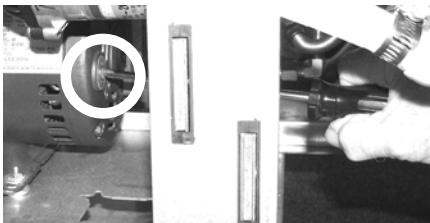

To reset the thermal overload switch:

1. Open middle door, locate pump and motor above drain pan and if the motor is hot, allow it to cool for about 5 minutes.
2. Since it takes some effort to reset the switch, use a tool, such as a Phillip's-head screwdriver, to press against the reset button until an audible "click" is heard.

**7-14. FILTER PUMP &
MOTOR (Continued)**



To avoid electrical shock or property damage, move the power switch to OFF and disconnect main circuit breaker, or unplug cord at wall receptacle.

Motor Removal:

1. Open the right door and remove JIB from fryer.
2. Open door to the left of the JIB and remove the drain pan.
3. Using a 1” wrench, disconnect the line at the elbow or tee on the front of the pump.



4. Using a 1” wrench, disconnect the line at fitting on the rear of the pump.



5. Using Phillip’s-head screwdriver, remove the rear cover from motor, exposing the wires.



6. Loosen the conduit clamp, disconnect wires, and pull the wires through the conduit clamp.

**7-14. FILTER PUMP &
MOTOR (Continued)**



7. Using 7/16 in. wrenches, remove 3 nuts, lockwashers, flat washers, spacer washer sets, and bolts securing the motor to the motor bracket.
8. Pull the pump and motor assembly from fryer.
9. Re-install pump and motor assembly following the above steps in reverse order; however, leave assembly mounting bolts and nuts loose and perform position adjustment after all electrical and plumbing connections are made.

To replace pump on motor:

1. Using a 1/2 in. wrench, remove 2 bolts securing the pump to the motor and pull the pump from the motor.
2. Install a new seal kit (part no. [17476](#)) onto shaft of motor.
3. Align the motor shaft motor with the pump rotor on the inside of pump body and push pump on motor shaft.
4. Secure the pump to the motor with the 2 bolts.

To adjust pump and motor assembly position:

1. Loosen bolts and nuts securing assembly to bracket.
2. Slide filter pan in under fryer on the rails until it rests against drain trough nozzle so drain pan cover opening is aligned with nozzle.
3. Check to be sure drain pan latch fully engages pan with about 1/16" (2 - 3 mm) of play. Adjust as needed.
4. Move pump and motor assembly so both O rings on drain pan fully engage Plug and Play connector and no O ring is visible.
5. Tighten bolts and nuts securing assembly to bracket.

7-15. JIB PUMP

This pump keeps the vats filled (Auto Top-Off)

Replacement



To avoid electrical shock or property damage, move the power switch to OFF and disconnect main circuit breaker, or unplug cord at wall receptacle.



1. Disconnect and remove JIB and drain pan.
2. Using 7/8" wrench, disconnect line at elbow on left end of pump.
3. Using 7/8" wrench, disconnect line at front side of pump.
4. Hinge down center control panel, disconnect 2 wires at wire nuts and remove nut on ground stud.
5. Using 3/8" wrench, remove 4 nuts and pump assembly.
6. Remove fittings from faulty pump and attach fittings to the new pump, in the same orientation.
7. Install new pump assembly in fryer, in reverse order and then reconnect power to fryer.

7-16. AIF PC BOARD

The AIF board controls Automatic Intermittent Filtering.

Replacement



To avoid electrical shock or property damage, move the power switch to OFF and disconnect main circuit breaker, or unplug cord at wall receptacle.



1. Hinge down center control panel (right panel on 2 vat units).
2. Tag and pull connectors from AIF PC board located behind control panel.
3. Using 5/16" socket, remove 6 nuts and board from fryer.
4. Install new PC board in reverse order.

7-17. TRANSFORMERS

These components drop the line voltage to low voltage components such as, control board, AIF board and contactor coils. Each control transformer is equipped with an integral reset switch.

Checkout:



To avoid electrical shock or property damage, move the power switch to OFF and disconnect main circuit breaker, or unplug cord at wall receptacle.



Control Transformer

1. Support control panel bottom with 1 hand, loosen retaining screw at top, slide panel down slightly to clear screw, push panel back up, then swing panel top out and down.
2. Press reset button on control transformer. If transformer does not reset, continue with procedure.
3. Pull appropriate connector, either from the AIF PC board or from the control PC board.



To avoid electrical shock, use care when checking transformer. The following checks are performed with wall circuit breaker closed and main power switch in ON position.



AIF Transformer

4. With power on, take a voltage reading on the appropriate pins. If transformer proves faulty, continue with replacement instructions.

Replacement:

1. Disconnect electrical power and using a 5/16" socket, remove nuts securing transformer and pull transformer from unit.
2. Replace transformer in reverse order.
3. Support control panel bottom with 1 hand, swing panel top up about 90 degrees, slide panel down slightly to clear screw, push panel up to engage screw, and tighten screw.

7-18. FILTER MOTOR RELAY

This component is located behind the left control panel and regulates voltage to the filter motor. Part No. is [ME90-008](#).

Replacement



To avoid electrical shock or property damage, move the power switch to OFF and disconnect main circuit breaker, or unplug cord at wall receptacle.

1. Support control panel bottom with 1 hand, loosen retaining screw at panel top, slide panel down slightly to clear screw, push panel back up, then swing panel top out and down.
2. Label and remove wires from relay.
3. Using a 5/16" socket, remove nuts securing the relay and remove relay from fryer.
4. Install new relay in reverse order.
5. Support control panel bottom with 1 hand, swing panel top up about 90 degrees, slide panel down slightly to clear screw, push panel up to engage screw, and tighten screw.

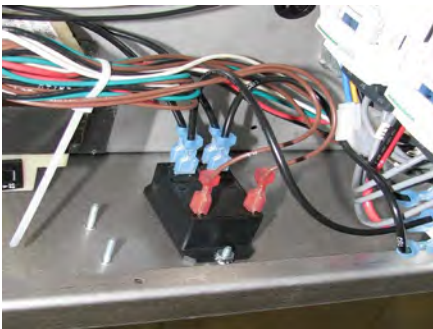

7-19. CHECK VALVE

A check valve is installed in the fill line to each vat to keep oil from flowing out of the vat.

Replacement



To avoid electrical shock or property damage, move the power switch to OFF and disconnect main circuit breaker, or unplug cord at wall receptacle.

1. Disassemble flexible oil lines and fittings from valve as necessary.
2. Apply Loctite Primer (Henny Penny part no. [MS01-572](#)) to internal threads of both the inlet and outlet of valve.
3. Reassemble fittings to check valve and install valve and oil lines.

Apply Primer Here



Apply Primer Here

7-20. DRAIN PAN SWITCH



Switch (P/N 85653) closes when drain pan is properly positioned under fryer. If drain pan is not properly in place, or drain switch is faulty, prompts such as, “CHECK PAN”; “FILTER PAN MISSING”; “CHANGE FILTER PAD” show in display.



To avoid electrical shock or property damage, move power switch to OFF and disconnect main circuit breaker, or unplug cord at wall receptacle.



1. Support control panel bottom with 1 hand, loosen retaining screw at panel top, slide panel down slightly to clear screw, push panel back up, then swing panel top out and down.
2. Locate the 8-pin connector on the AIF PC board and pull the connector from the board.
3. Check for proper continuity between the pins with wires labeled D1 & D2. Switch can fail “open” or “closed”. If drain pan switch is defective, continue with replacement instructions below.



Removal:

1. Drain pan switch is located under right frame rail on which drain pan slides. Using a “stubby” 3/8” nut driver or socket, remove 2 nuts securing switch to frame.
2. Using same tool, remove 3 nuts and wire clamps from under frame rail.
3. Separate connector between the right and center doors (below magnets) and push plug down through frame rail.
4. Mount new switch under rail and secure with 2 nuts. Route wires through clamps, secure clamps to studs with nuts, and push plug up through rail and connect.
5. Support control panel bottom with 1 hand, swing panel top up about 90 degrees, slide panel down slightly to clear screw, push panel top up to engage screw, then tighten screw.



7-21. FILTER AND JIB LIGHTS

Replacement



To avoid electrical shock or property damage, move the power switch to OFF and disconnect main circuit breaker, or unplug cord at wall receptacle.



1. Support control panel bottom with 1 hand, loosen retaining screw at panel top, let panel slide down slightly to clear screw, push panel back up, then swing panel top out and down.

2. Locate wires to light and cut wires.



3. Using a 13/16" deep-well socket (see photo at left), remove nut on back side of panel and pull light from panel front.

4. Install new light with deep-well socket, connect wires with wire nuts.

5. Support control panel bottom with 1 hand, swing panel top up about 90 degrees, let panel slide down slightly to clear screw head, push panel top up to engage screw, then tighten screw.

6. Restore power to the unit.

7-22. OIL LEVEL PROBES

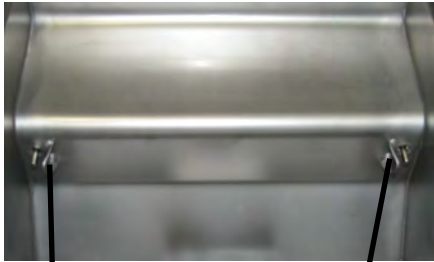

Right Oil Level Probe

Left Oil Level Probe

The oil level probes monitor the oil level by temperature differences. If they become disabled, the display shows: “E-18A”= left probe; “E18-B”= right probe; “E18C”= both. Note that left and right are as viewed from front of fryer.

Also, if any of the probes are out of calibration more than 10°F, or 10°C, the probe should be replaced. An Ohm check can be performed also. See chart below left.

Checkout:



To avoid electrical shock or property damage, move the power switch to OFF and disconnect main circuit breaker, or unplug cord at wall receptacle.

Temp. F	Temp. C	Resistance Ohms	Temp. F	Temp. C	Resistance Ohms
50	10.00	1039.02	250	121.11	1464.79
60	15.56	1060.65	260	126.67	1485.71
70	21.11	1082.24	270	132.22	1506.58
80	26.67	1103.80	280	137.78	1527.43
90	32.22	1125.32	290	143.33	1548.23
100	37.78	1146.81	300	148.89	1569.00
110	43.33	1168.26	310	154.44	1589.73
120	48.89	1189.67	320	160.00	1610.43
130	54.44	1211.05	325	162.78	1620.77
140	60.00	1232.39	330	165.56	1631.09
150	65.56	1253.70	340	171.11	1651.72
160	71.11	1274.97	350	176.67	1672.31
170	76.67	1296.20	360	182.22	1692.86
180	82.22	1317.40	365	185.00	1703.13
185	85.00	1327.99	370	187.78	1713.38
190	87.78	1338.57	380	193.33	1733.87
200	93.33	1359.69	390	198.89	1754.31
210	98.89	1380.79	400	204.44	1774.72
212	100.00	1385.00	410	210.00	1795.10
220	104.44	1401.84	420	215.56	1815.44
230	110.00	1422.86	430	221.11	1835.74
240	115.56	1443.85	440	226.67	1856.01

1. Support control panel bottom with 1hand, loosen retaining screw at panel top, let panel slide down slightly to clear screw, push panel back up, then swing panel top out and down.
2. Pull probe connector on the left side, from control panel and locate terminals in connector for probe being tested. Attach meter leads onto those terminals and refer to chart at left to determine if probe is good or not. (Probe wires are labeled, with #1 being the far left probe.)

Replacement:

1. Reattach control panel and restore power to fryer.
2. Drain oil from vat.
3. Using Phillip’s-head screwdriver, loosen retaining screw from control panel top and swing down the control panel-.
4. Pull probe connector on left side of control panel.
5. Follow lead wires through insulation down to desired probe.
6. Using a 1/2” wrench, remove nut on compression fitting and remove oil level probe from vat.



7-22. OIL LEVEL PROBES
(Continued)



7. Place connector on flat surface with the open side up.
8. Hold connector in place with one hand, use other hand to insert pocket knife blade or other small sharp tool into connector notch to depress metal locking tab.
9. Continue to hold locking tab down and pull lead wire out of the rear of connector and remove probe from fryer.
10. Place nut and new ferrule on new oil level probe and insert probe into compression fitting.
11. Follow probe installation instructions below:

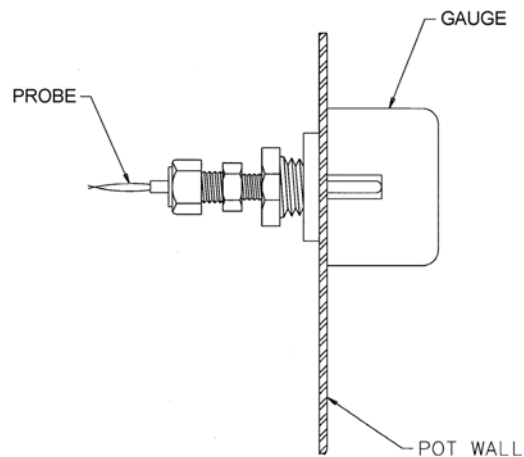

- NOTE:
- 1.) LOCATE TEMPERATURE PROBE THRU POT WALL.
 - 2.) PLACE GAUGE AGAINST POT WALL AS SHOWN.
 - 3.) PUSH TEMPERATURE PROBE THRU UNTIL IT MAKES CONTACT WITH GAUGE.
 - 4.) TIGHTEN TEMPERATURE PROBE IN PLACE.

CAUTION

Excess force will damage temperature probe. Hand-tighten nut and then 1/2 turn with a wrench.

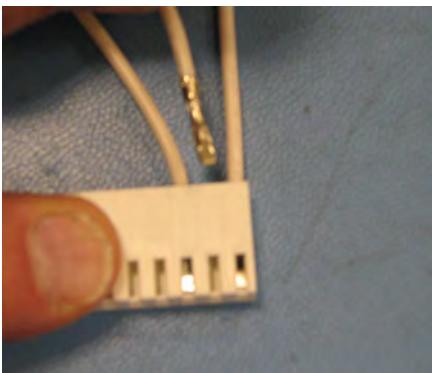

12. With locking tab up, insert pin into connector opening and visually check that tab is fully engaged. Fasten connector on to control panel.
13. Support control panel bottom with 1 hand, swing panel top up about 90 degrees, let panel slide down slightly to clear screw, push panel up to engage screw, then tighten screw.
14. Reconnect power to vat and fill vat with oil.

7-23. MANUAL OPERATION OF DRAIN VALVE

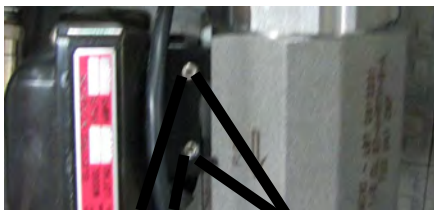
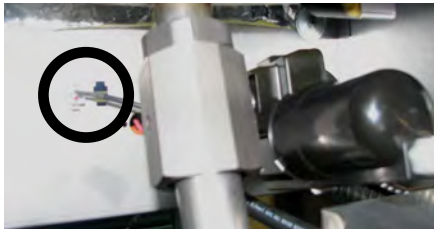

Set Screws

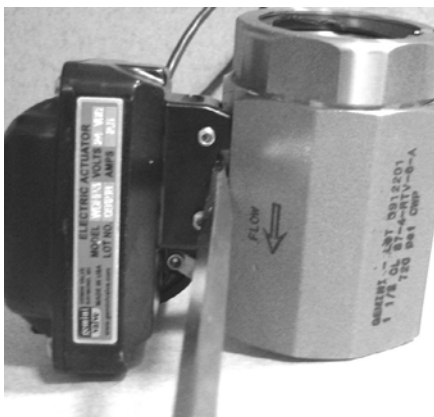

Should the actuation motor of a drain valve cease to operate, the drain valve can be operated manually as follows.



To avoid electrical shock or property damage, move the power switch to OFF and disconnect main circuit breaker, or unplug cord at wall receptacle.

1. Support control panel bottom with 1 hand, loosen retaining screw at panel top, let panel slide down slightly to clear screw, push panel back up, then swing panel top out and down.
2. Trace wires from P12 on panel to vertical wall of controls area and separate required connector.
3. Using a 7/32" Allen wrench, loosen and unscrew 2 set screws until almost removed.
4. Using a flat blade screwdriver, pry motor from valve body.
5. Using a 1/4" or adjustable wrench, turn square stub shaft to operate valve ball.
6. Assemble in reverse order.
7. Support control panel bottom with 1 hand, swing panel top up about 90 degrees, let panel slide down slightly to clear screw head, push panel top up to engage screw, then tighten screw.

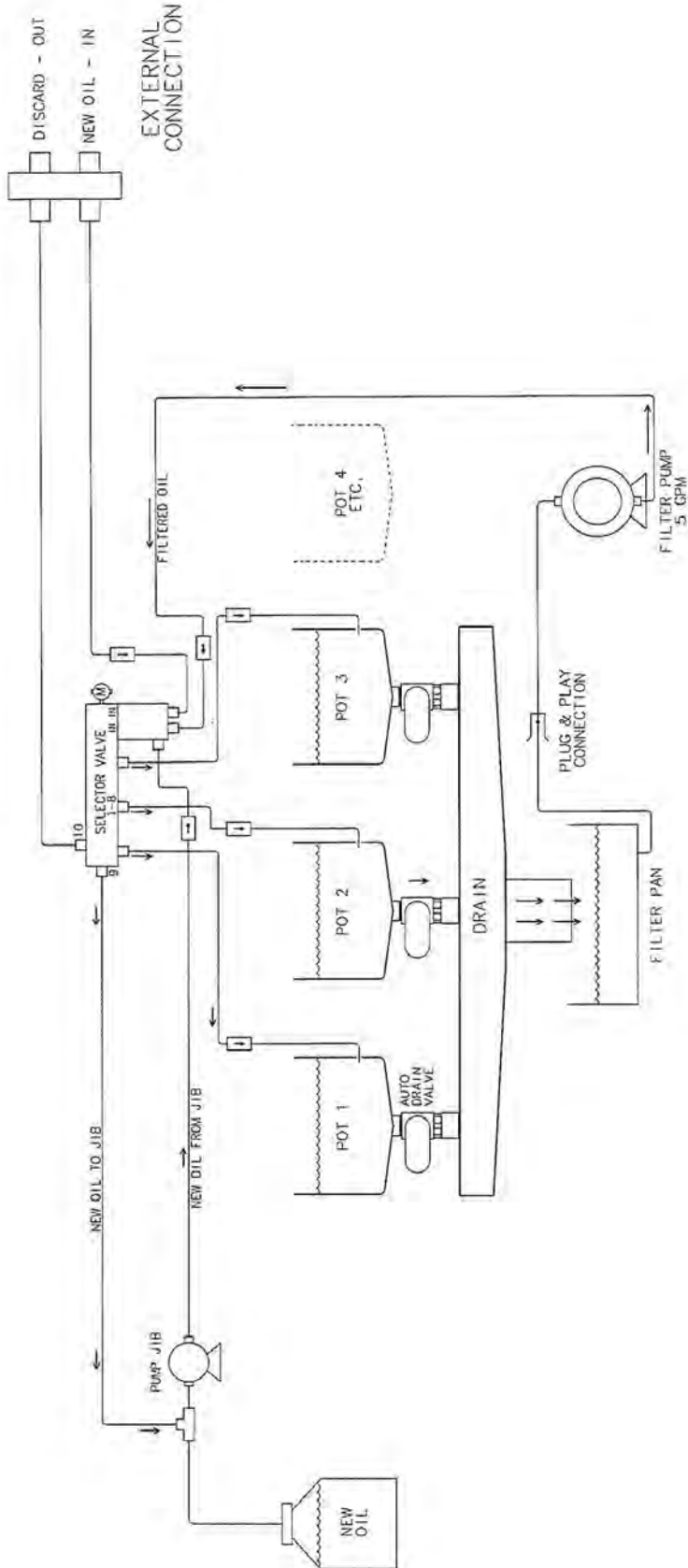

NEW OIL 9
DISCARD OIL 10

9	10
---	----

9	10
---	----

↑ HOME POSITION

SELECTOR VALVE PORT CONFIGURATION

SSSS

PORT #	1	2	3	4	5	6	7	8
--------	---	---	---	---	---	---	---	---

FFFF

PORT #	2	4	6	8
--------	---	---	---	---

Plumbing Diagram

RTI/HENNY PENNY SYSTEM OPERATION

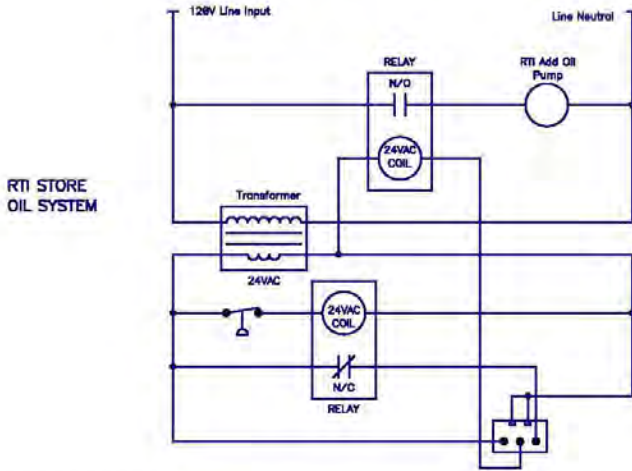

- RTI SYSTEM OPERATION:**
1. RTI system supplies 24VAC on Black and White wires.
 2. Connecting Green to Black turns on the RTI Add Oil Pump.
 3. RTI system outputs 24VAC on Red and White when tank is full.
 4. Connecting Black to Brown activates RTI Dispose Valve.
 5. Relay in RTI switch box normally deactivates the Dispose Valve when the RTI tank is full. (This is not used on the Henry Penny system. It is software controlled in the Henry Penny System.)

INTERCONNECT CABLE FROM STORE RTI SYSTEM TO FRYER

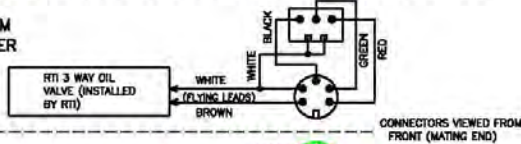

HENNY PENNY FRYER TO RTI INTERFACE CONTROL

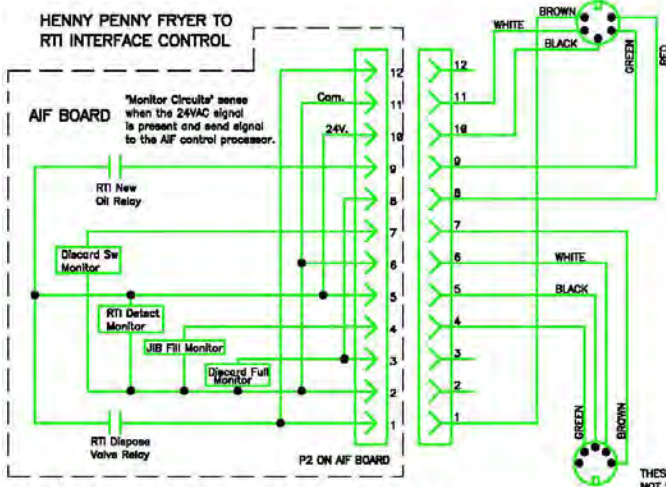

- Henry Penny System Operation:**
1. Monitors the 24VAC supplied on the RTI Black and White wires to determine when it is hooked up to the RTI system.
 2. Monitors the RTI "Tank Full" signal on the Red and White wires. It will not turn on the Pump and "Dispose Valve" when the "Tank Full" signal is present. Software versions P-83D and later will display "RTI TANK FULL" on the control display.
 3. Monitors RTI "Dispose Switch" on the Brown and White wires and turns on Pump and "Dispose Valve" (closes relay between the Brown and Black wires) if "Tank Full" signal is not present.
 4. Monitors RTI "Add Oil" switch on the Green and White wires and connects the Black and Green wires to turn on the RTI Add Oil pump. Also energizes the Henry Penny Add Oil Solenoid.

INTERCONNECT CABLE FROM FRYER TO RTI SWITCH BOX

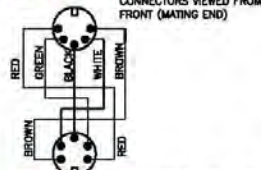

RTI ADD/DISPOSE SWITCH BOX

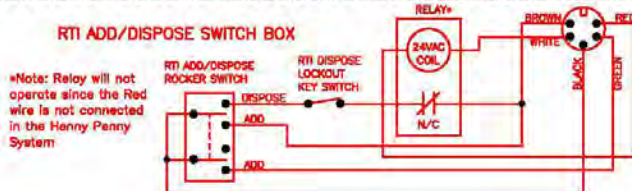

*Note: Relay will not operate since the Red wire is not connected in the Henry Penny System

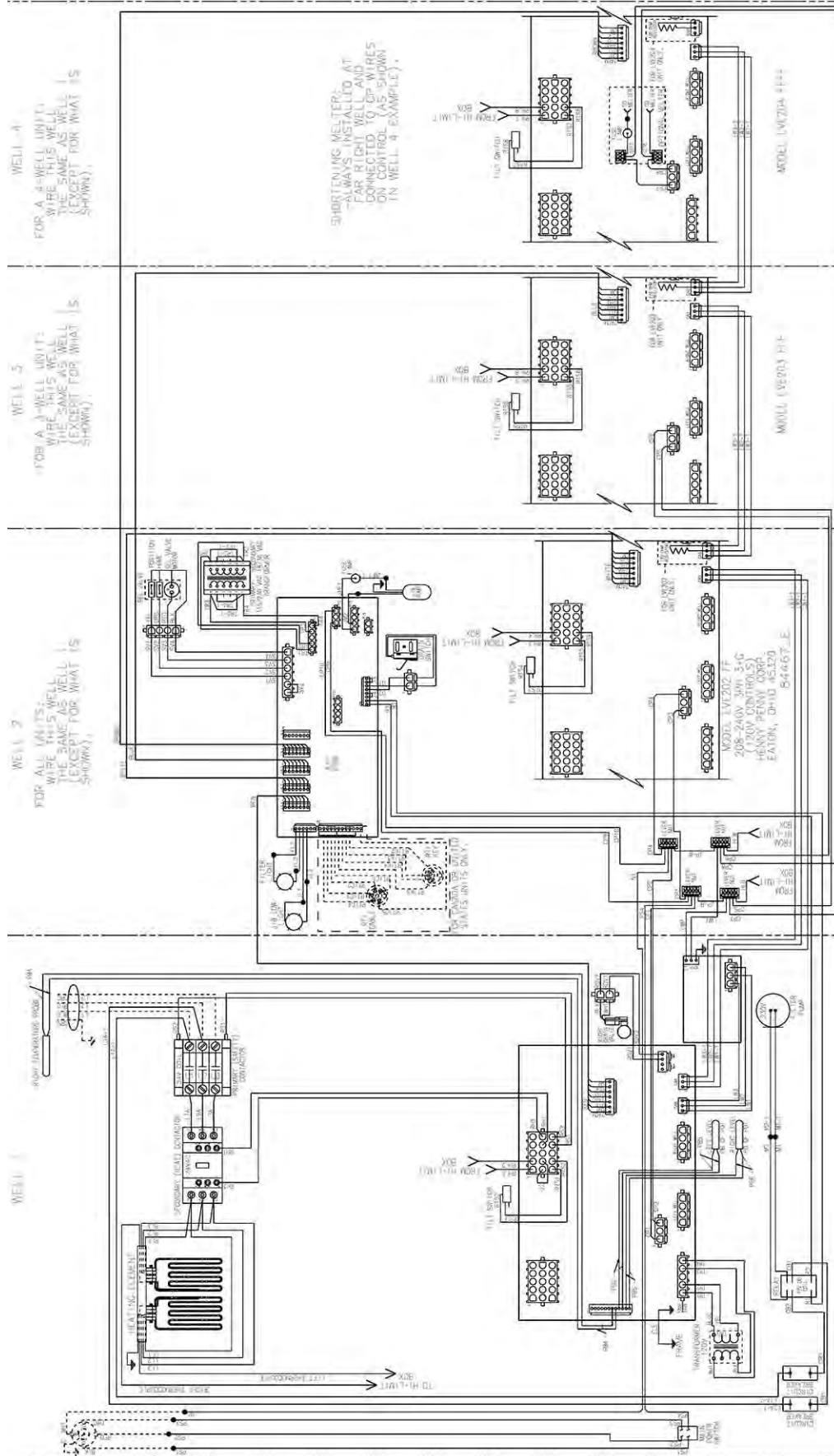

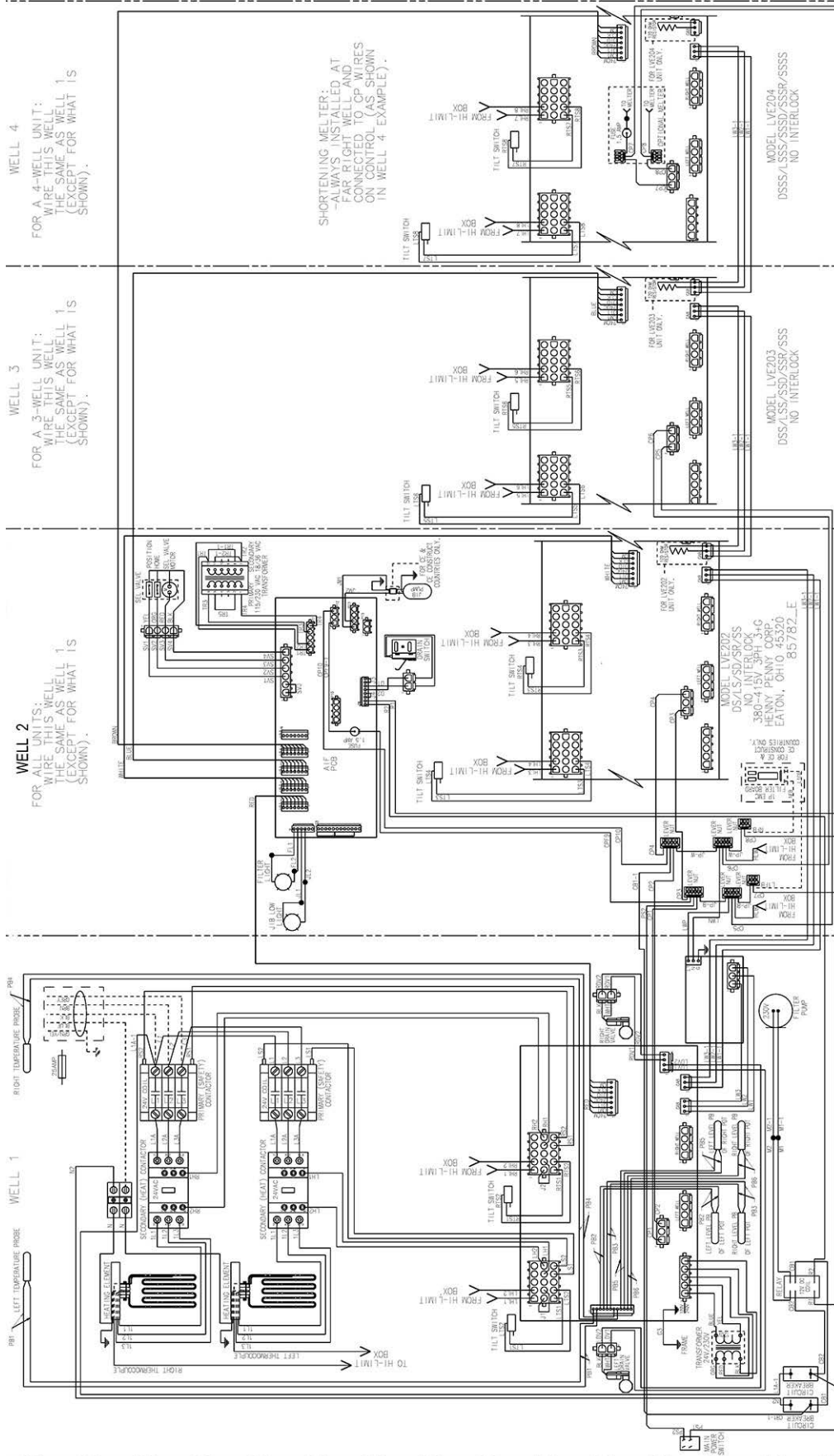

HI-LIMIT
MODEL LVE202 FF
HENNY PENNY CORP.
EATON, OHIO 45320

84708_A

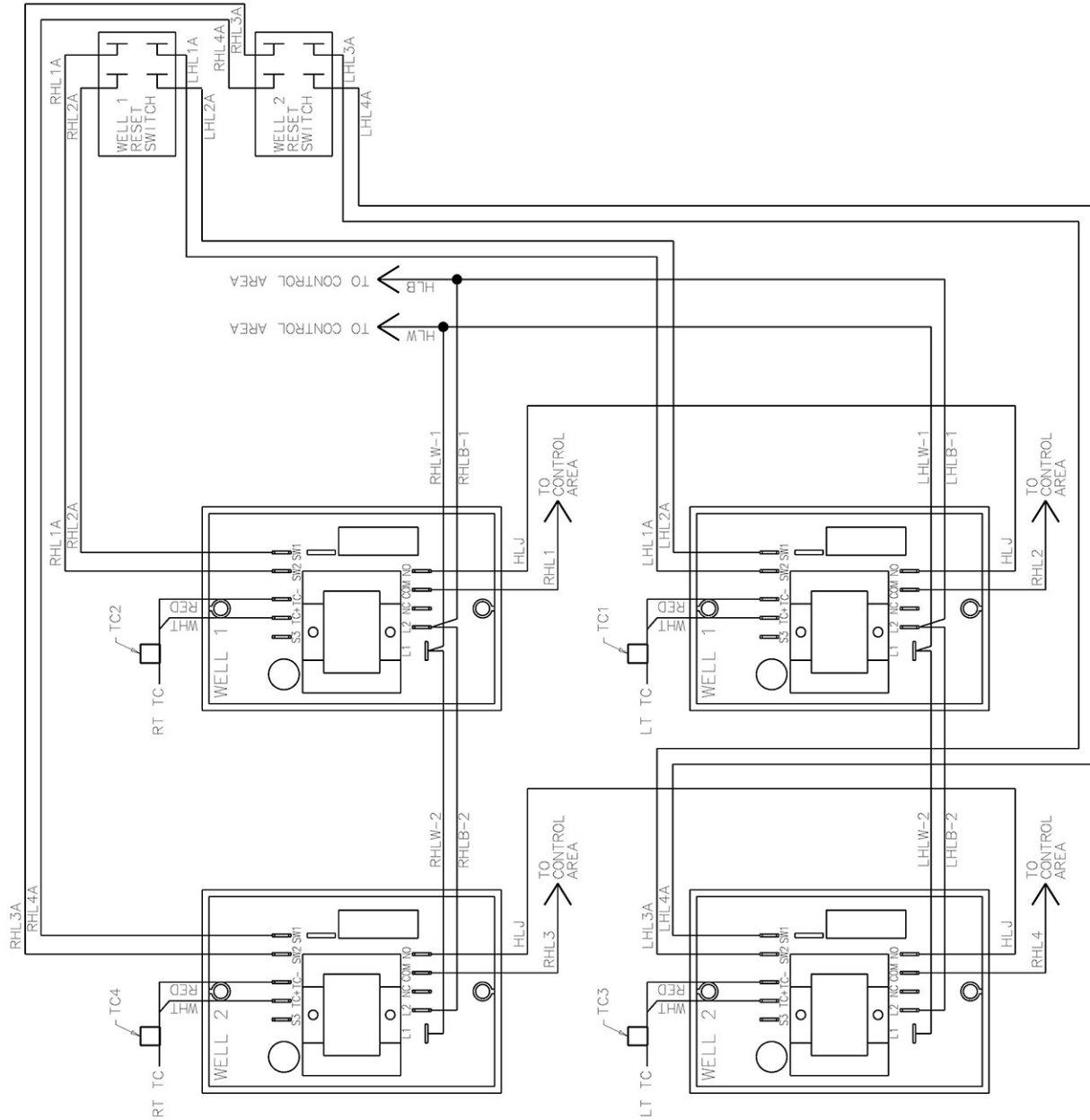

HI-LIMIT
MODEL LVE202
DS/LS/SD/SR/SS
HENNY PENNY CORP.
EATON, OHIO 45320

84709_A

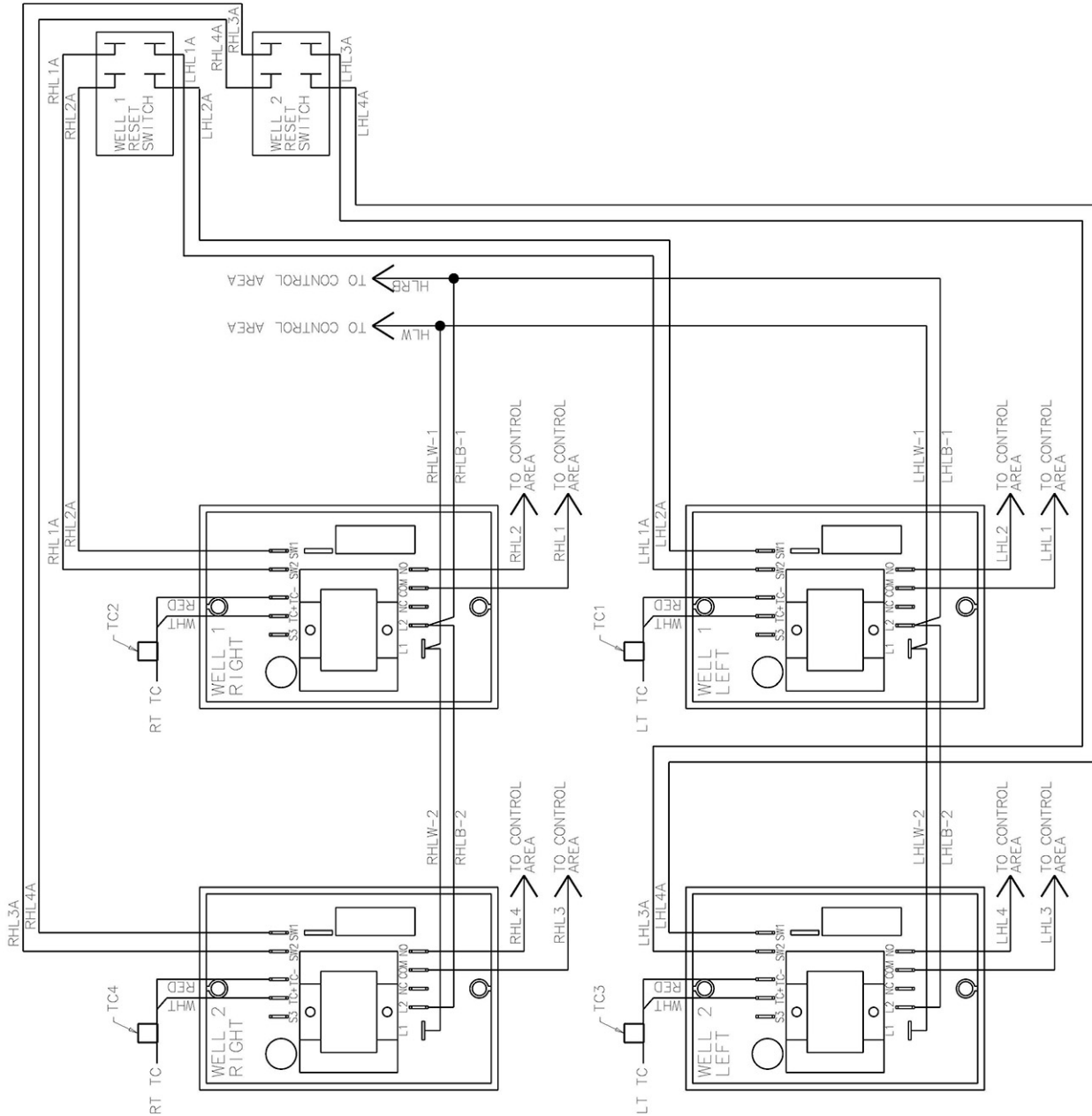

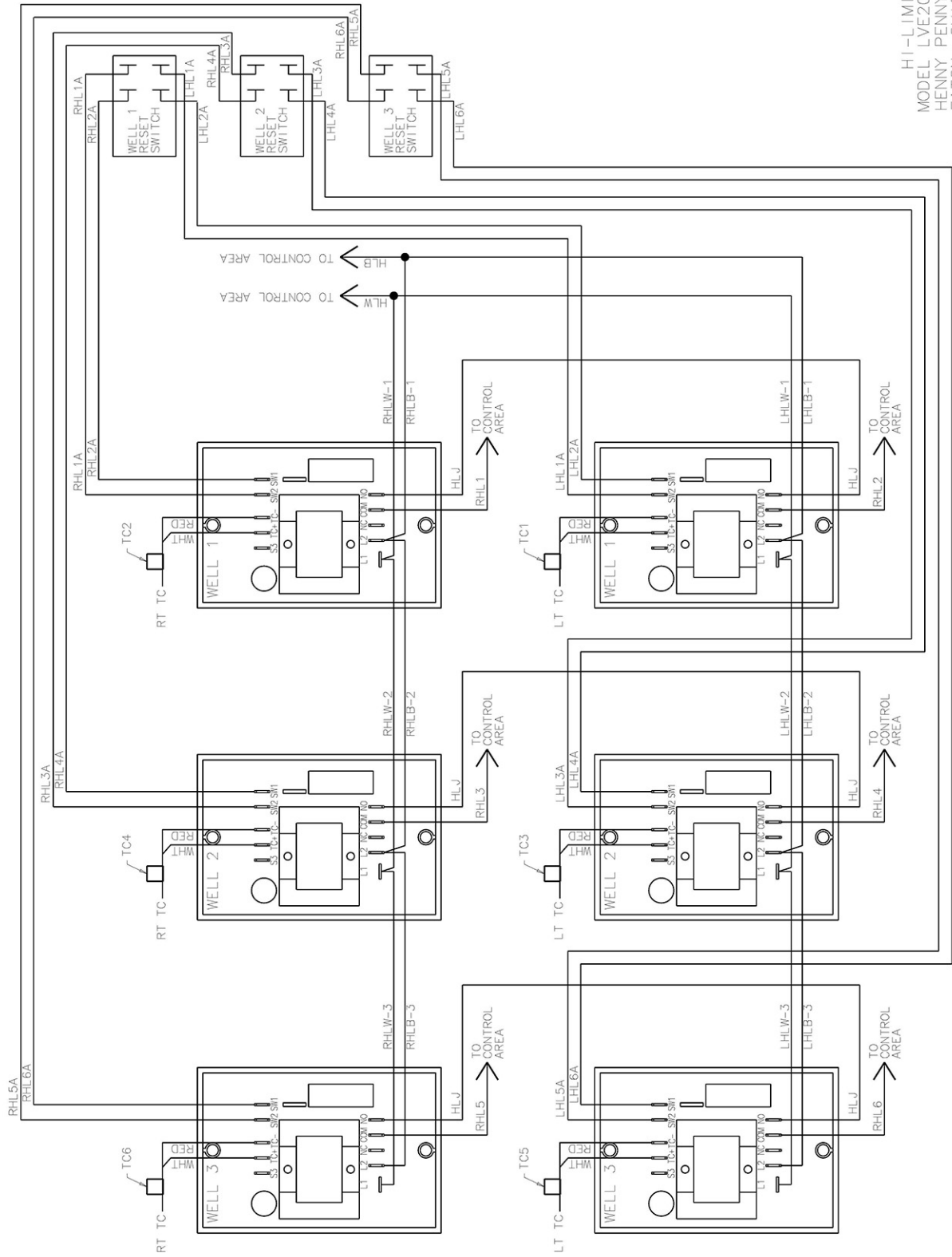

HI-LIMIT
MODEL LVE203 FFF
HENNY PENNY CORP.
EATON, OHIO 45320
84710_A

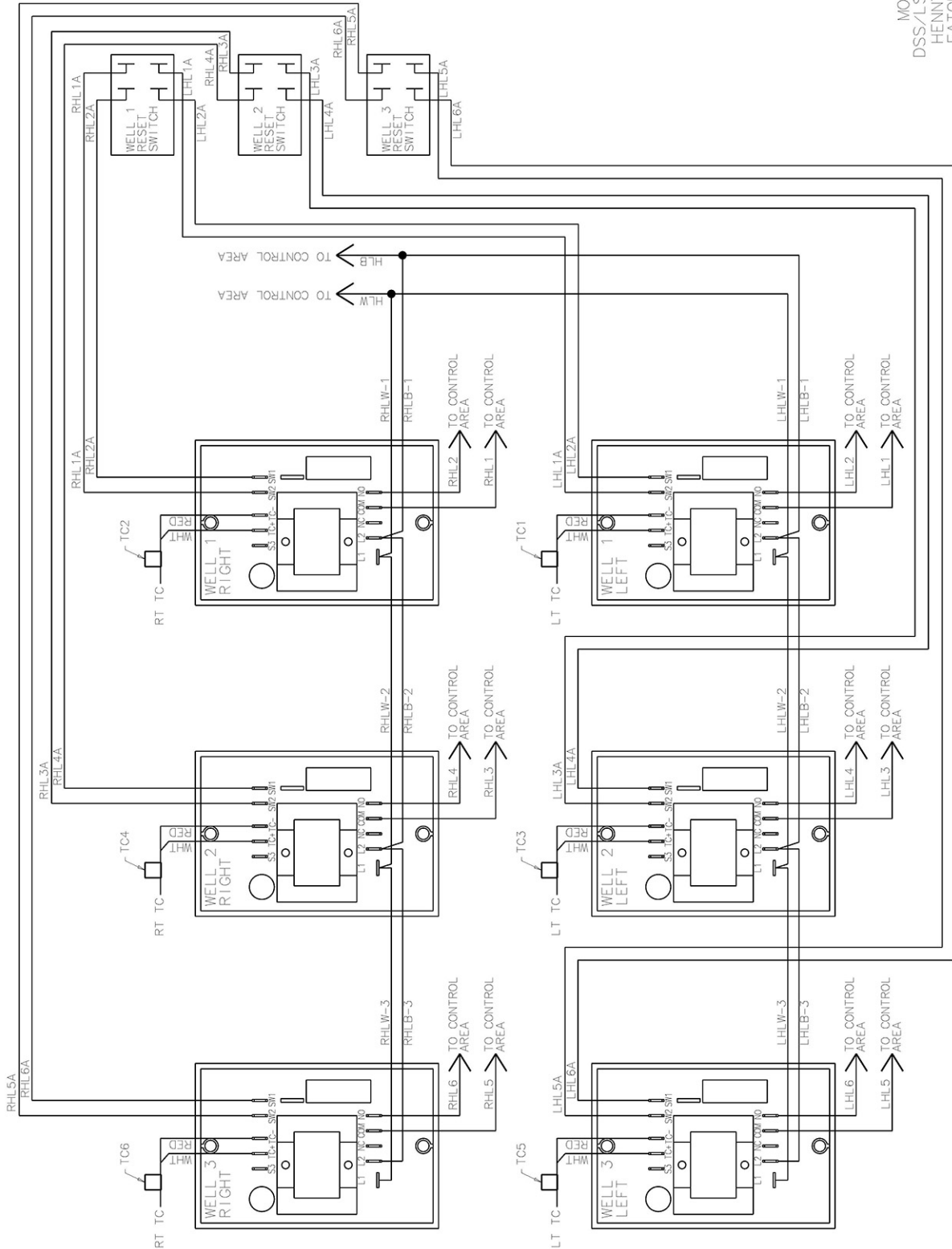

HI-LIMIT
MODEL LVE203
DSS/LSS/SSD/SSR/SSS
HENNY PENNY CORP
EATON, OHIO 45320
84711_A

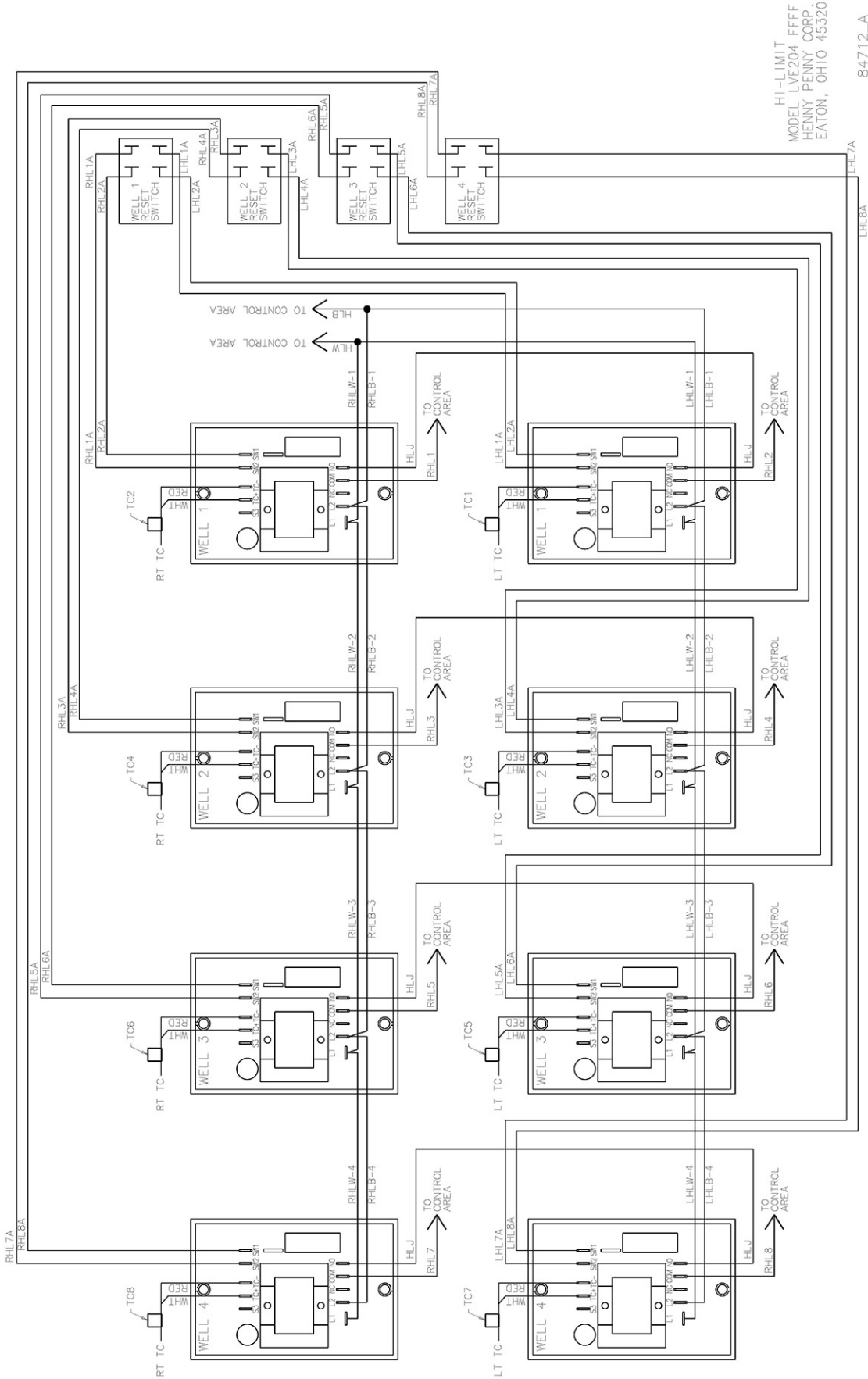

HI-LIMIT
MODEL LVE204 FFFF
HENNY PENNY CORP.
EATON, OHIO 45320
84712_A

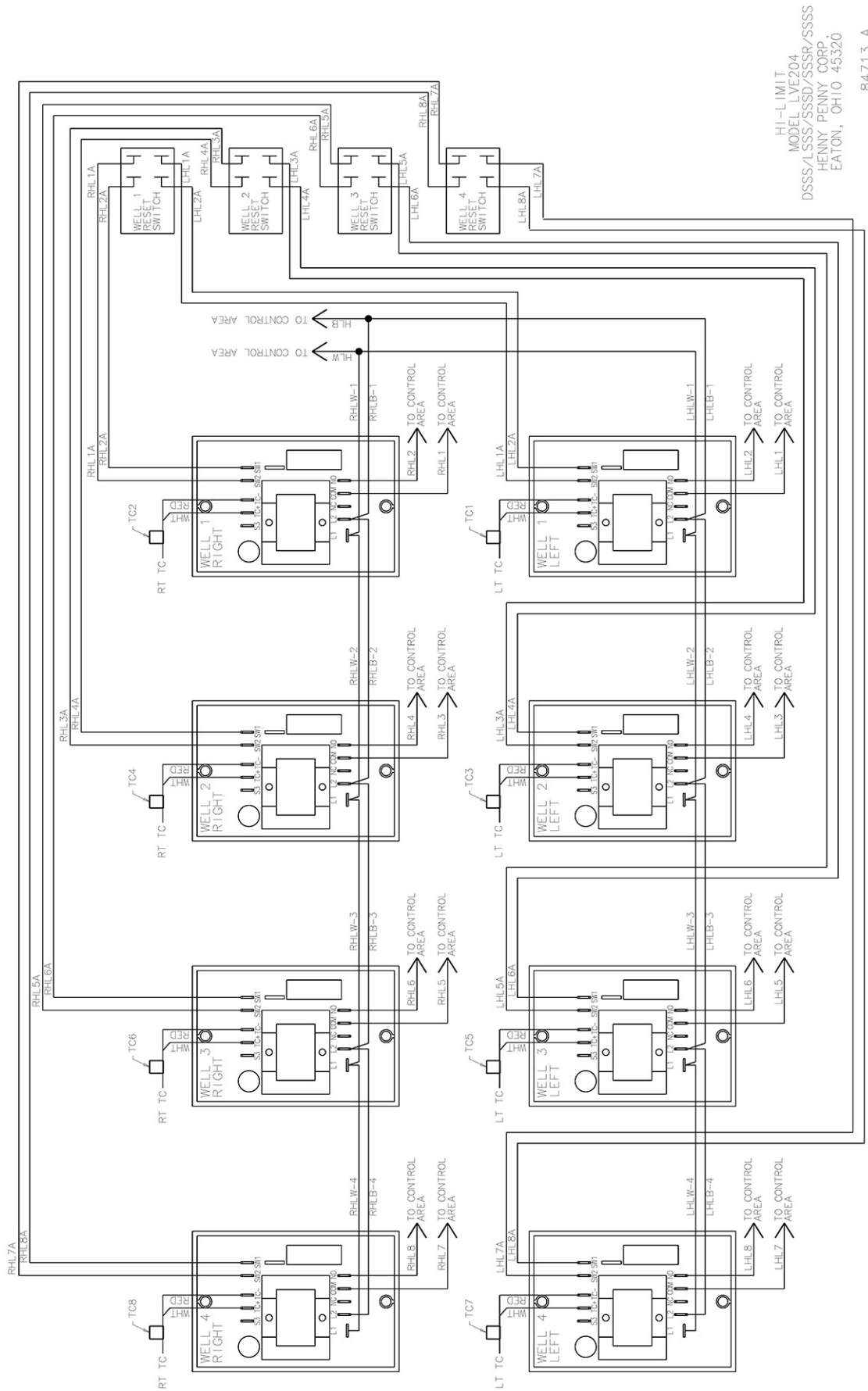

HI-LIMIT
MODEL LVE204
DSSS/LSSS/SSSD/SSSR/SSSS
HENNY PENNY CORP.
EATON, OHIO 45320
84713_A

SECTION 8. PARTS INFORMATION

8-1. INTRODUCTION

This section lists the replaceable parts of the Henny Penny Model LVE fryer.

8-2. GENUINE PARTS

Use only genuine Henny Penny parts in your fryer. Using part of lesser quality or substitute design may result in damage to the unit or personal injury.

8-3. WHEN ORDERING PARTS

Once the parts that you want to order have been found in the parts list, write down the following information:

Item Number 2
Part Number 60241 Example:
Description High Limit

From the data plate, list the following information:

Product Number 01100
Serial Number 0001 Example:
Voltage 208

8-4. PRICES

Your distributor has a price parts list and will be glad to inform you of the cost of your parts order.

8-5. DELIVERY

Commonly replaced items are stocked by your distributor and will be sent out when your order is received. Other parts will be ordered, by your distributor, from Henny Penny Corporation. Normally, these will be sent to your distributor within three working days.

8-6. WARRANTY

All replacement parts (except lamps and fuses) are warranted for 90 days against manufacturing defects and workmanship. If damage occurs during shipping, notify the carrier at once so that a claim may be properly filed. Refer to warranty in the front of this manual for other rights and limitations.

8-7. RECOMMENDED SPARE PARTS FOR DISTRIBUTORS

Recommended replacement parts are indicated with A or B in the parts lists:

A = parts to be stocked on service vans or trucks

B = parts to be stocked at the distributor/KES location.

Inventory on all other parts not identified, should be based upon usage in the territory. Please use care when ordering recommended parts, because all voltages and variations are marked. Distributors should order parts based upon common voltages and equipment sold in their territory.

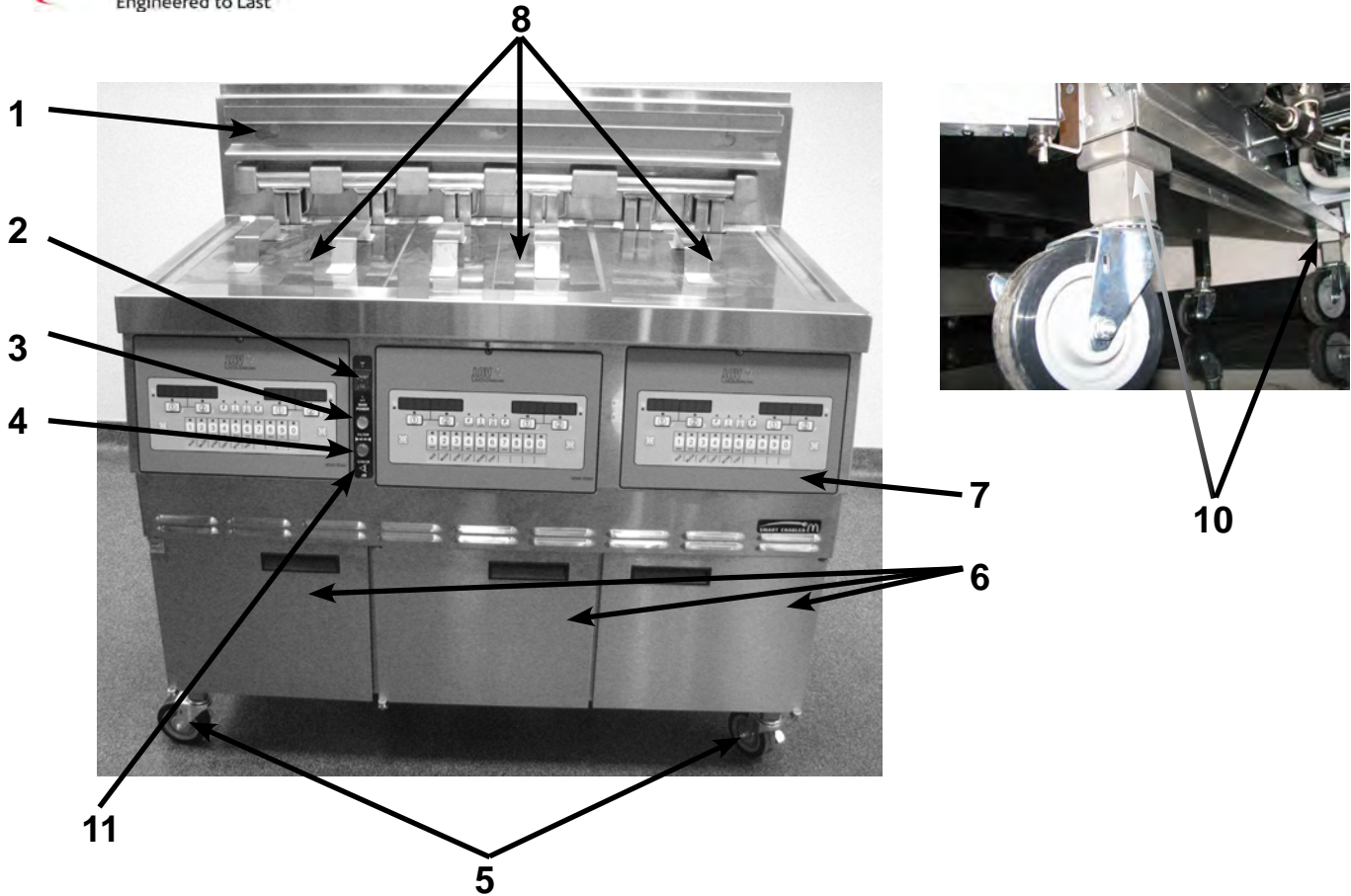

Item No.	Part No.	Description	Quantity
1	77842	HANGER-BASKET - LVE-202.....	1
1	77709	HANGER-BASKET - LVE-203.....	1
1	77934	HANGER-BASKET - LVE-204.....	1
A 2	52224	SWITCH - POWER.....	1
B 3	75860	LIGHT - INDICATOR - BLUE.....	1
B 4	75859	LIGHT - INDICATOR - YELLOW	1
5	77575	CASTER - 4" - W/BRAKE.....	2
6	-----	DOOR..... See Chart on Next Page	
B 7	83515RB	ASSY - CONTROL - LOV.....	1/well**
8	03623	WELD ASSY - COVER - SPLIT VAT.....	1/vat
8	03624	WELD ASSY - COVER - FULL VAT.....	1/vat
9*	77679	CASTER - REAR - 4"	2
10	83933	SUPPORT - CASTER MTG LVE 203/204.....	4
10	83937	SUPPORT - CASTER MTG LVE 202	4
11	77103	DECAL-FLTR/CK JIB/MAIN POWER	1
12*	03691	ACCESSORY-BLUE LIGHT BAR 3W.....	1

Recommend Parts: A=Truck Stock/B=Dist. Stock

*not shown

**LVE-202=2; LVE-203=3; LVE-204=4

83774 LH Door Assy without Holder	86382 RH Door Assy with Holder
--	---

Model LVE-202

83774 LH Door Assy without Holder	83774 LH Door Assy without Holder	86382 RH Door Assy with Holder
--	--	---

Model LVE-203

83774 LH Door Assy without Holder	83774 LH Door Assy without Holder	83727 RH Door Assy without Holder	86382 RH Door Assy with Holder
--	--	--	---

Model LVE-204

Door Hinge Chart					
Door	Top Hinge (Door)	Bottom Hinge (Door)	Left Hinge (Frame)	Right Hinge (Frame)	Bushing
83774	83903	83904	85409	-	39752
86382	83904	83903	-	85408	39752
83727	83904	83903	-	85408	39752

Control Panel Assembly

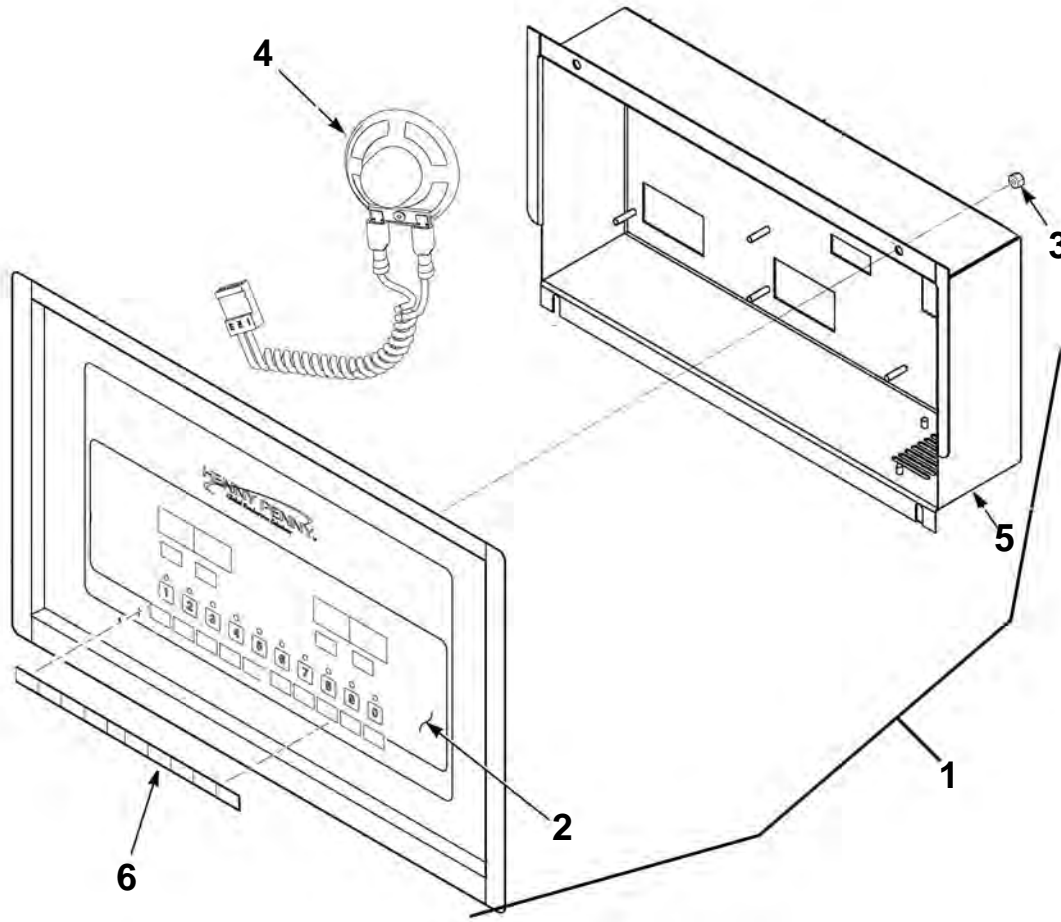

Item No.	Part No.	Description	Quantity
B 1	83515RB	ASSY - CONTROL - LOV	1/well**
2	85378	DECAL - LOV MCD.....	1/control
3	NS02-005	NUT - HEX KEPS #6-32 C.....	23/control
B 4	26974	ASSY - SPEAKER	1/control
5	83498	STUD ASSY - CONTROL PANEL COVER	1/control
6	77249	MENU CARD - BLANK - LOV	1/control
6	77250	MENU CARD - FVA - LOV.....	1/control
6	77251	MENU CARD - SPA - LOV	1/control
A 7*	MS01-571	TOOL - TERMINAL EXTRACTOR (not shown)	1
8	140130	KIT-LVE/LVG-MMC COMM.....	1

Recommend Parts: A=Truck Stock/B=Dist. Stock

*not shown

**LVE-202=2; LVE-203=3; LVE-204=4

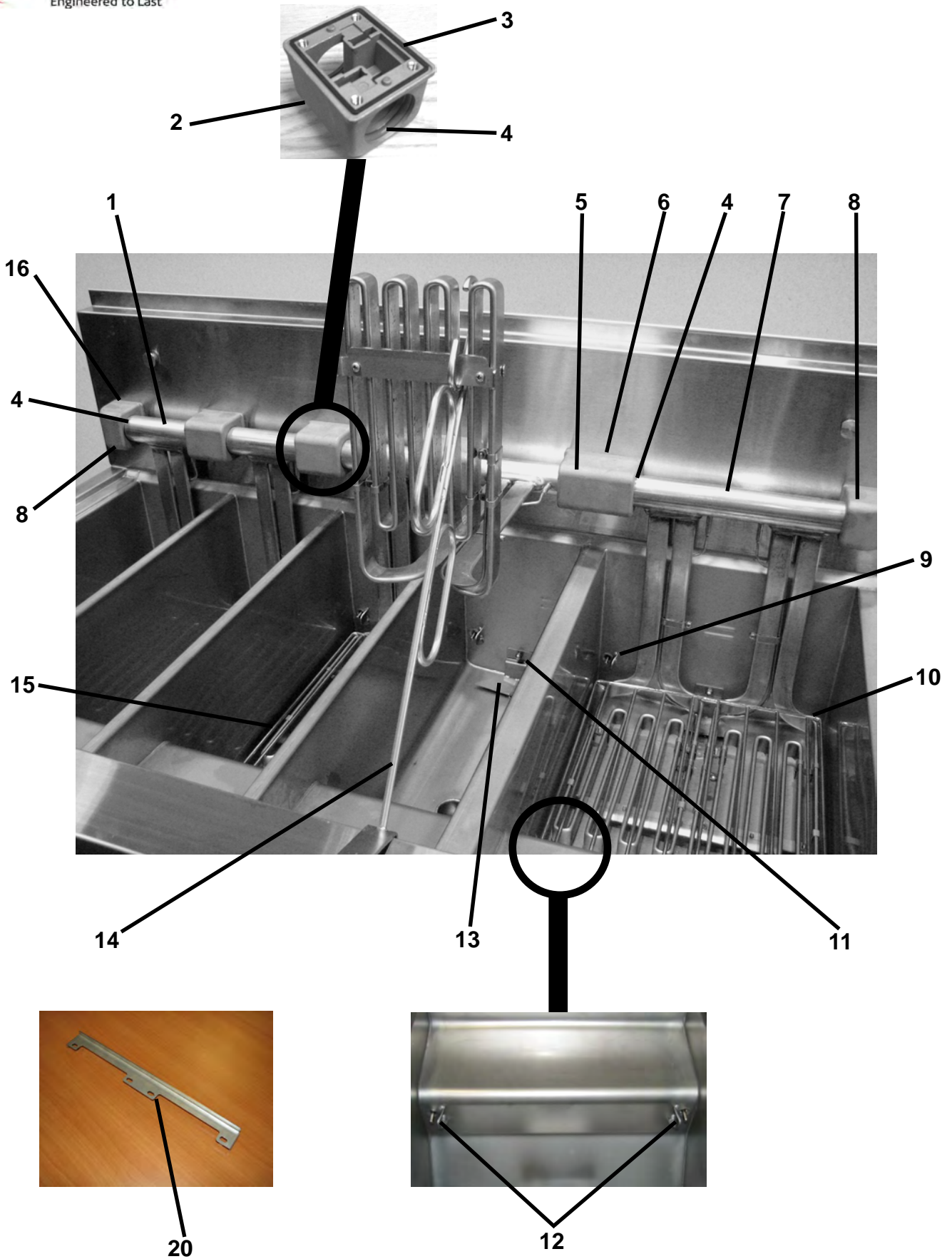

NOTICE Replace seals & o-rings when replacing elements

Item No.	Part No.	Description	Quantity
B 1	92104-001	ELEMENT-7 KW-SPLIT,208-60-3, 3 wire	1/split
B 1	92104-002	ELEMENT-7 KW-SPLIT, 230/400-50-3, 4 wire	1/split
B 1	92104-005	ELEMENT-7 KW-SPLIT, 220/380-50/60-3, 4 wire	1/split
B 1	92104-006	ELEMENT-7 KW-SPLIT, 240/415-50-3, 4 wire	1/split
B 1	92104-007	ELEMENT-7 KW-SPLIT, 220-60-3, 3 wire	1/split
B 1	92104-008	ELEMENT-7 KW-SPLIT, 230-50-3, 3 wire	1/split
B 1	92104-009	ELEMENT-7 KW-SPLIT, 240-60-3, 3 wire	1/split
2	86305	BLOCK-PIVOT-S TO S (See chart on next page)	AR
B 3	86308	SEAL-S TO S PIVOT BLOCK (See chart on next page)	AR
B 4	76948	O-RING.....	2/block
5	86304	BLOCK-PIVOT-S TO F (See chart on next page)	AR
B 6	86307	SEAL-S TO F PIVOT BLOCK (See chart on next page)	AR
B 7	92103-001	ELEMENT-14 KW-FULL, 208-60-3, 3 wire	1/full
B 7	92103-002	ELEMENT-14 KW-FULL, 230/400-50-3, 4 wire	1/full
B 7	92103-005	ELEMENT-14 KW-FULL, 220/380-50/60-3, 4 wire	1/full
B 7	92103-006	ELEMENT-14 KW-FULL, 240/415-50-3,4 wire	1/full
B 7	92103-007	ELEMENT-14 KW-FULL, 220-60-3, 3 wire	1/full
B 7	92103-008	ELEMENT-14 KW-FULL, 230-50-3, 3 wire	1/full
B 7	92103-009	ELEMENT-14 KW-FULL, 240-60-3, 3 wire	1/full
8	86303	BLOCK-PIVOT-F TO F (See chart on next page)	AR
A 9	140099	KIT-TEMPERATURE PROBE (3").....	1/vat
B 10	84942	RACK - FULL VAT (w/o wear strip).....	1/vat
11	NS03-044	NUT - ACORN - #10-24 - SS.....	1/vat
A 12	140098	KIT-OIL LEVEL PROBE (2-1/2").....	2/vat
13	77838	WELD ASSY- LOV OIL DIVERTER.....	1/vat
13	77443	WELD ASSY- FISH OIL DIVERTER	1/vat
B 14	74725	HANDLE - ELEMENT LIFT.....	1
B 15	84943	RACK - SPLIT VAT	1/vat
B 16	86306	SEAL-F TO F PIVOT BLOCK (See chart on next page)	AR
17*	76563	WELD ASSY - SEAM COVER - LVE-202	1
17*	76500	WELD ASSY - SEAM COVER - LVE-203	1
17*	77613	WELD ASSY - SEAM COVER - LVE-204	1
18*	76564	EXTENSION-SHROUD - LVE-202	1
18*	76501	EXTENSION-SHROUD - LVE-203	1
18*	77614	EXTENSION-SHROUD - LVE-204	1
19*	NS03-044	NUT - ACORN - #10-24 - SS.....	3
20	140288	KIT-FULL LVE20X ELEMENT GUARD.....	1/vat
20	140300	KIT-SPLIT LVE20X ELEMENT GUARD	1/vat
21*	96887	KIT-THERMOCOUPLE LVE200	1/vat

Recommend Parts: A=Truck Stock/B=Dist. Stock

*not shown

AR - as required; see chart on next page

FRYER MODEL	PIVOT BLOCK			PIVOT BLOCK SEAL		
	QTY	P/N & TYPE		QTY	P/N & TYPE	
202FF	4	86303	F TO F (end block)	4	86306	F TO F
203FFF	6	86303	F TO F (end block)	6	86306	F TO F
204FFFF	8	86303	F TO F (end block)	8	86306	F TO F
202SS	2	86303	F TO F (end block)	2	86306	F TO F
	3	86305	S TO S	3	86308	S TO S
203SSS	2	86303	F TO F (end block)	2	86306	F TO F
	5	86305	S TO S	5	86308	S TO S
204SSSS	2	86303	F TO F (end block)	2	86306	F TO F
	7	86305	S TO S	7	86308	S TO S
202FD/FR/FS	2	86303	F TO F (end block)	2	86306	F TO F
	1	86304	STO F	1	86307	S TO F
	1	86305	S TO S	1	86308	S TO S
203FSD/FSR/FSS	2	86303	F TO F (end block)	2	86306	F TO F
	1	86304	S TO F	1	86307	S TO F
	3	86305	S TO S	3	86308	S TO S
204FSSD/FSSR/FSSS	2	86303	F TO F (end block)	2	86306	F TO F
	1	86304	S TO F	1	86307	S TO F
	5	86305	S TO S	5	86308	S TO S
202DF/LF/SF	2	86303	F TO F (end block)	2	86306	F TO F
	1	86304	S TO F	1	86307	S TO F
	1	86305	S TO S	1	86308	S TO S
203FFD/FFR/FFS	4	86303	F TO F (end block)	4	86306	F TO F
	1	86304	S TO F	1	86307	S TO F
	1	86305	S TO S	1	86308	S TO S
204FFSD/FFSR/FFSS	4	86303	F TO F (end block)	4	86306	F TO F
	1	86304	S TO F	1	86307	S TO F
	3	86305	S TO S	3	86308	S TO S
203DSF/LSF/SSF	2	86303	F TO F (end block)	2	86306	F TO F
	1	86304	S TO F	1	86307	S TO F
	3	86305	S TO S	3	86308	S TO S
204FFFD/FFFR/FFFS	6	86303	F TO F (end block)	6	86306	F TO F
	1	86304	S TO F	1	86307	S TO F
	1	86305	S TO S	1	86308	S TO S
203DFF/LFF/SFF	4	86303	F TO F (end block)	4	86306	F TO F
	1	86304	S TO F	1	86307	S TO F
	1	86305	S TO S	1	86308	S TO S
204DSSF/LSSF/SSSF	2	86303	F TO F (end block)	2	86306	F TO F
	1	86304	S TO F	1	86307	S TO F
	5	86305	S TO S	5	86308	S TO S
204DSFF/LSFF/SSFF	4	86303	F TO F (end block)	4	86306	F TO F
	1	86304	S TO F	1	86307	S TO F
	3	86305	S TO S	3	86308	S TO S
204DFFF/LFFF/SFFF	6	86303	F TO F (end block)	6	86306	F TO F
	1	86304	S TO F	1	86307	S TO F
	1	86305	S TO S	1	86308	S TO S

Note: See Model Variant Legend on page 8-13 for model configuration explanation.

ELEMENT HARDWARE

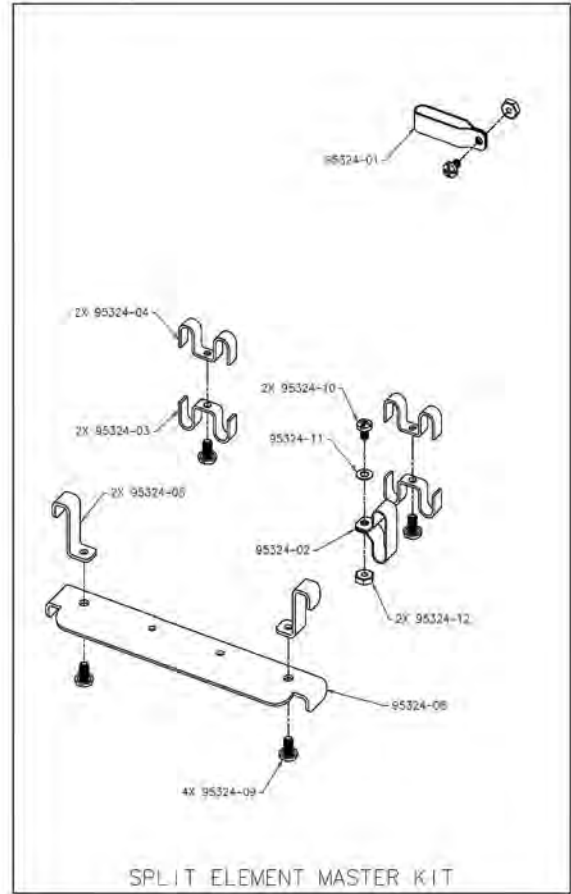
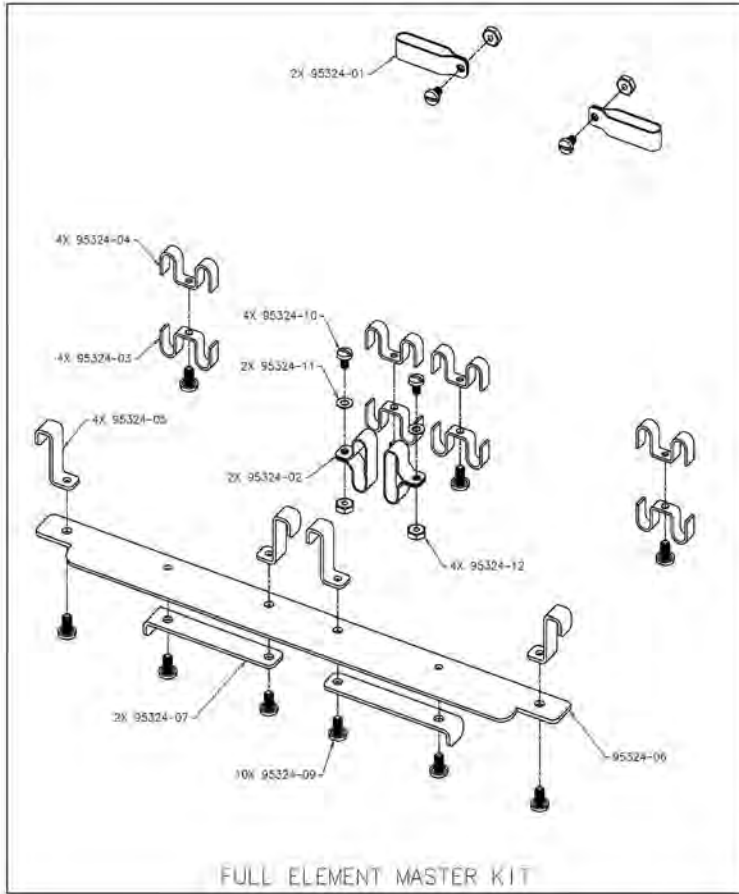

P/N	WATLOW P/N	DESCRIPTION	FULL ELEMENT	SPLIT ELEMENT
95324-01	165-53-21-1	CLIP-HI LIMIT TIP	2	1
95324-02	165-53-22-1	CLIP-HI LIMIT REAR	2	1
95324-03	71-53-1561-1	SPACER-ELEMENT LOWER	4	2
95324-04	71-53-1561-2	SPACER-ELEMENT UPPER	4	2
95324-05	71-53-1540-1	BRACKET-FOOT TOP	4	2
95324-06	71-15-1500-1	BRACKET-FOOT MOUNTING FULL	1	—
95324-07	71-15-1525-1	BRACKET-FOOT BOTTOM FULL	2	—
95324-08	71-53-1489-1	BRACKET-FOOT BOTTOM SPLIT	—	1
95324-09	429-80-45-38	SCREW-#8-AB X .375 LONG	10	4
95324-10	429-80-34-26	SCREW-#8-32 X .250 LONG	4	2
95324-11	523-60-1-50	WASHER	4	2
95324-12	363-60-1-6	NUT-#8-32 SS	4	2

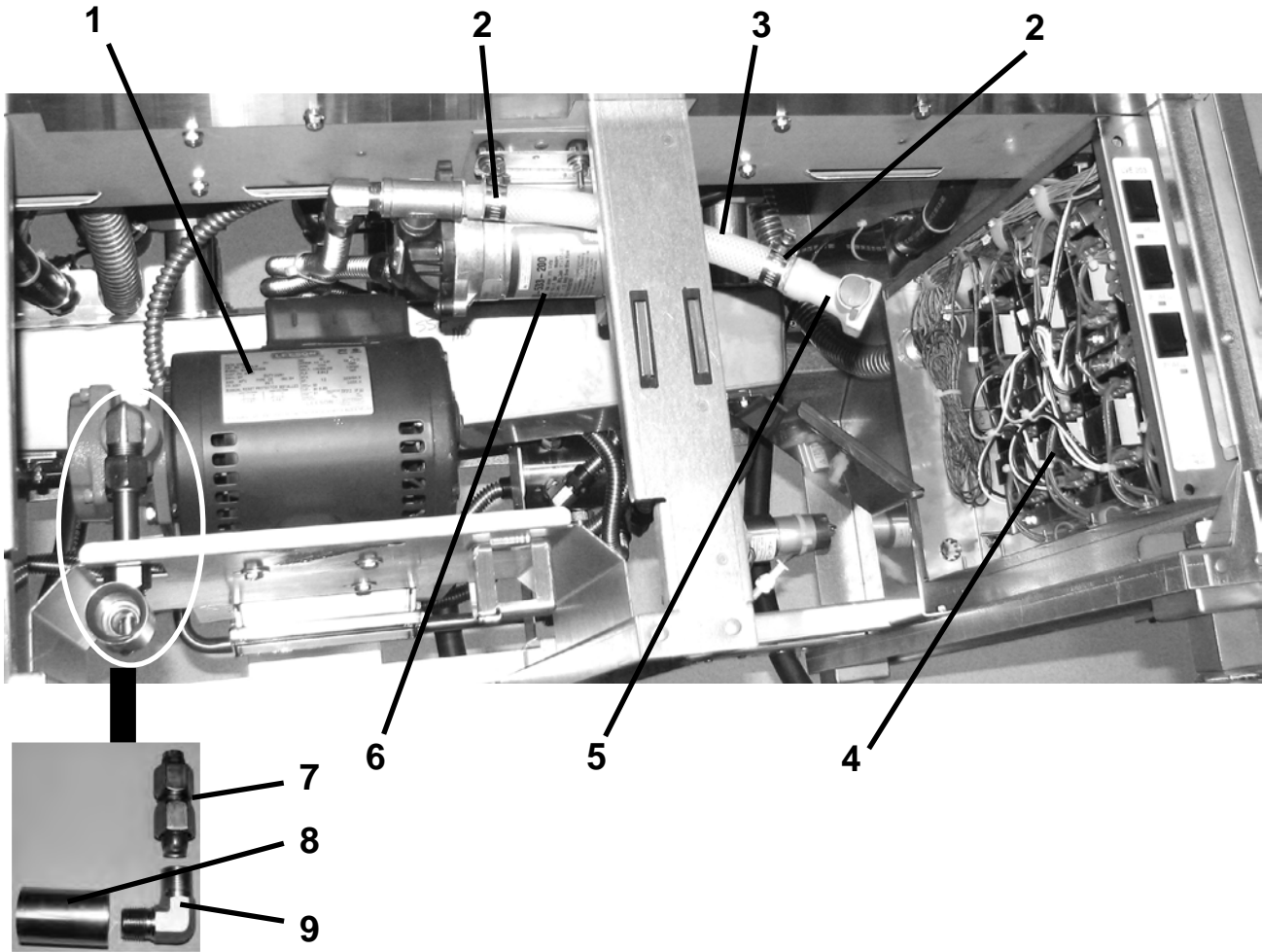

Item No.	Part No.	Description	Quantity
1	85777	PUMP & MOTOR ASSY.-60 HZ (See page 8-15 for details)	1
1	93297	PUMP & MOTOR ASSY.-50 HZ (See page 8-15 for details)	1
2	MS01-297	CLAMP-HOSE.....	2
B 3	89622-001	HOSE.....	1
A 4	83581-001	CONTROL-HIGH LIMIT-120V (120V control/hood interlock circuit)	1/vat
A 4	83581-002	CONTROL-HIGH LIMIT-230V(230V control/hood interlock circuit)	1/vat
B 5	FP05-016	DISCONNECT-QUICK-1/2".....	1
B 6	73473	PUMP - OIL TOP OFF - 120V (120V control/hood interlock circuit).	1
B 6	74583	PUMP - OIL TOP OFF - 230V(230V control/hood interlock circuit)..	1
7	84288	ASSY - FILTER INLET TUBE.....	1
8	83429	ADAPTOR - TUBE END.....	1
9	17407	CONNECTOR - 1/2 MALE ELBOW.....	1

Recommend Parts: A=Truck Stock/B=Dist. Stock

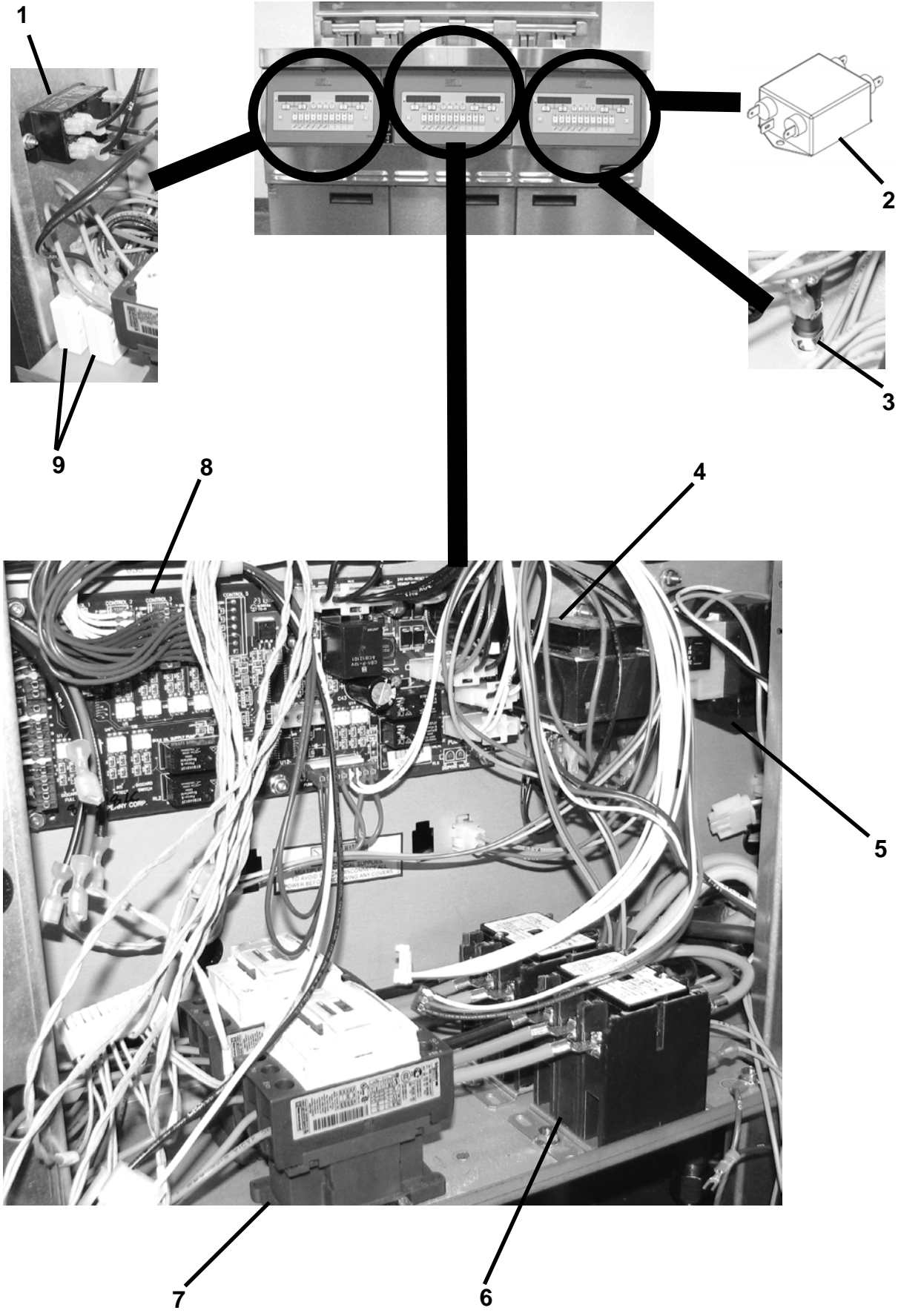

Item No.	Part No.	Description	Quantity
B 1	ME90-008	RELAY - PUMP MOTOR- 12 VDC - 30 AMP.....	1
B 2	80728	EMI FILTER - CE	1
A 3	EF02-104	FUSE HOLDER - 20A-250V	1
A 3	FA52-010	FUSE - 1 AMP (208/240V FRYERS).....	1
A 3	FA52-015	FUSE - 1.5 AMP (380/400/415V FRYERS).....	1
B 4	TS22-012	TRANSFORMER - AIF	1
A 5	86086	TRANSFORMER-120V/75VA	1/vat
A 5	86087	TRANSFORMER (CE)-24V/240V/75VA	1/vat
A 6	29509	CONTACTOR - 24V COIL (Primary Contactor)	1/vat
A 7	65073	CONTACTOR - 24V COIL (Heat Contactor).....	1/vat
B 8	85698RB	PC BOARD - SELECTOR AIF	1
A 9	EF02-125	BREAKER-PUSH BUTTON RESET - 15 AMP	2

Recommend Parts: A=Truck Stock/B=Dist. Stock

* not shown

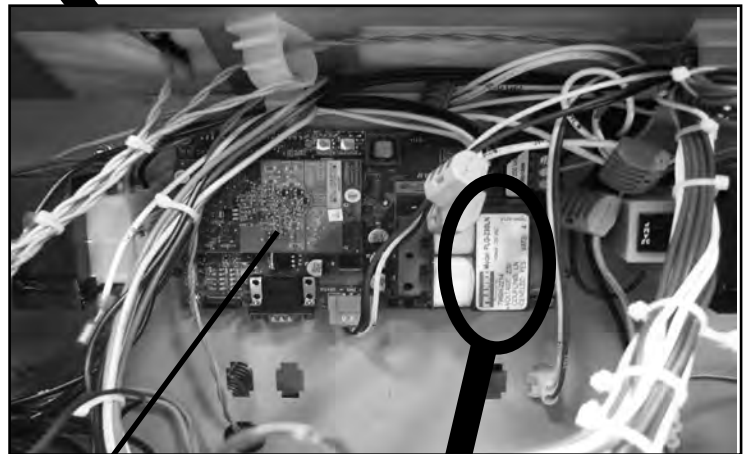
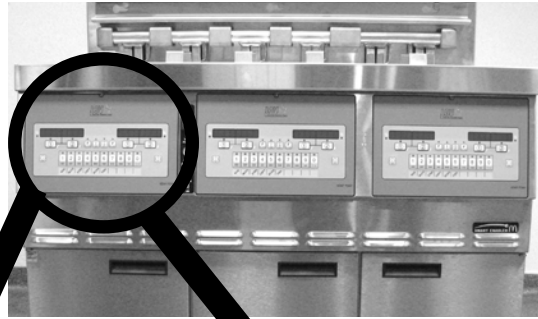

1

2

CENELEC YES/NO
Refer to chart below



Item No.	Part No.	Description	Quantity
B 1	82914	FILTER BOARD - 1P EMC - CE	1
2	79596-XXXX	GATEWAY - PCB (LONWORKS) see chart below.....	1

Part No.	Voltage	Transceiver Type	Model
79596-1202	115	NON-CENELEC	LVE-202
79596-1203	115	NON-CENELEC	LVE-203
79596-1204	115	NON-CENELEC	LVE-204
79596-2202	230	NON-CENELEC	LVE-202
79596-2203	230	NON-CENELEC	LVE-203
79596-2204	230	NON-CENELEC	LVE-204
79596-2212	230	CENELEC	LVE-202
79596-2213	230	CENELEC	LVE-203
79596-2214	230	CENELEC	LVE-204

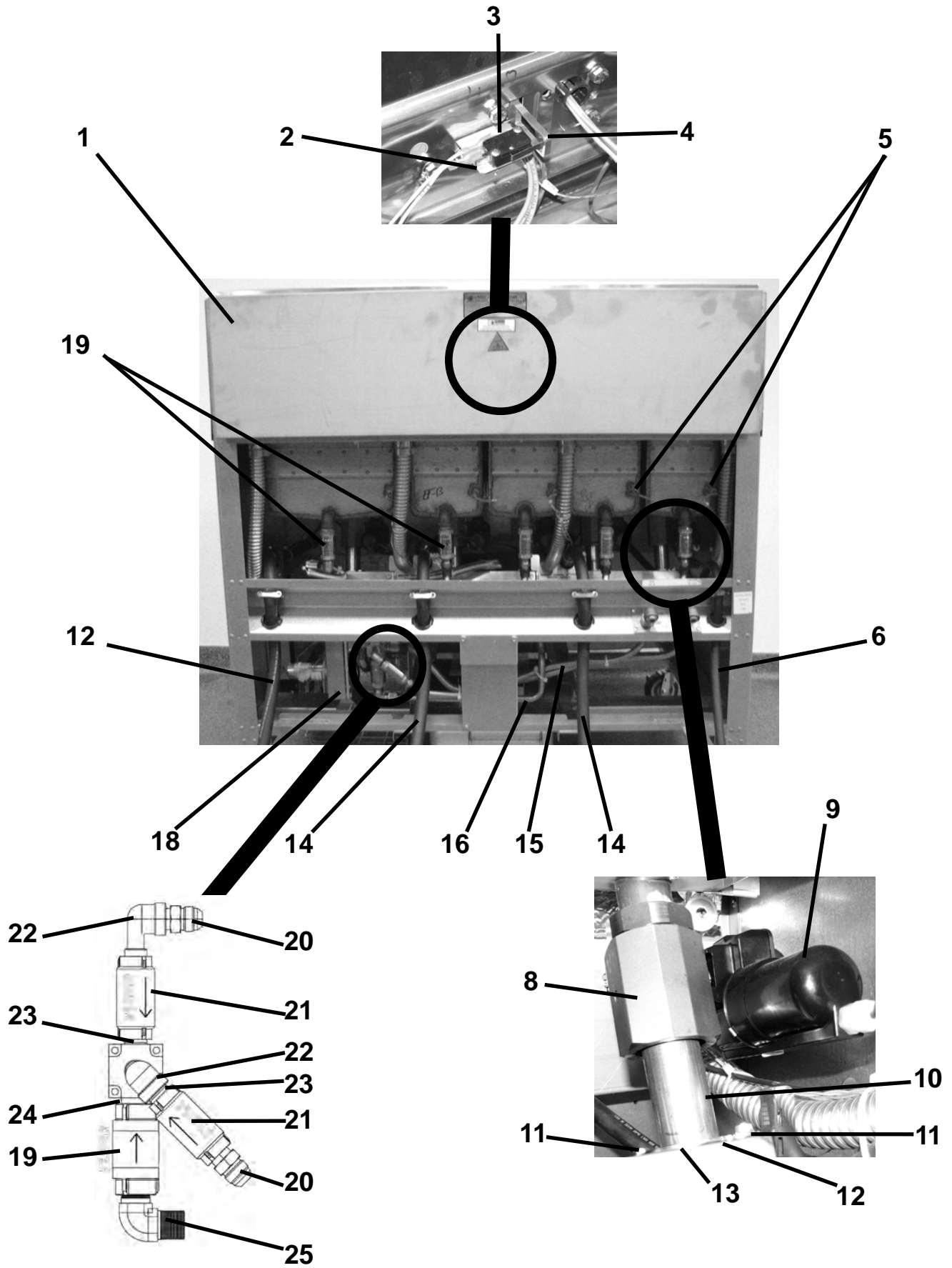

Item No.	Part No.	Description	Quantity
1	84372	COVER - REAR SHROUD - LVE-202	1
1	83681	COVER - REAR SHROUD - LVE-203	1
1	86345	COVER - REAR SHROUD - LVE-204	1
2	83034	BRACKET-SWITCH MOUNTING	1/vat
A 3	83096	SWITCH - ELEMENT LIFT	1/vat
4	83038	ARM-ELEMENT SENSE.....	1/vat
A 5	140099	PROBE - TEMPERATURE (3").....	1/vat
6	83333	ASSY-CORD & PLUG-INTERLOCK 120V	1
6	85335	ASSY-CE CORD & PLUG-INTERLOCK	1
6	85754	ASSY-CONTROL POWER CORD-FRANCE	1
6	85758	ASSY-CONTROL POWER CORD (8 FT)-ITALY	1
6	85759	ASSY-CORD & PLUG INTERLOCK-SINGAPORE/HONG KONG....	1
6	85763	ASSY-CORD & PLUG INTERLOCK-NEW ZEALAND	1
7	81911	ASSY-DRAIN ACTUATOR W/O-RINGS	1/vat
B 8	140244	KIT- DRAIN VALVE W/O MODULE	AR
	76948	O-RING -325 (between drain valve and trough).....	AR
B 9	86157	MOTOR-ACTUATOR	AR
10	95704-001	TUBE-FISH VALVE TO TROUGH	1/vat
10	95704-002	TUBE-S/F VALVE TO TROUGH	1/vat
11	NS04-004	NUT.....	2
12	86442	SHIM.....	2
13	84419	CLAMP	1
14	83331	ASSY - POWER CORD & PLUG - 208-240V	**
14	85337	ASSY - CE POWER CORD & PLUG	**
14	85760	ASSY - POWER CORD & PLUG - SINGAPORE/HONG KONG.....	**
14	85761	ASSY - POWER CORD & PLUG - NORWAY.....	**
14	85762	ASSY - POWER CORD & PLUG (8 FT) - ITALY	**
14	85764	ASSY - POWER CORD & PLUG - AUSTRALIA	**
14	85765	ASSY - POWER CORD & PLUG - NEW ZEALAND.....	**
15	77523-0XX	TUBE-SUCTION (See chart on next page).....	AR
16	88679	ASSY-TUBE-PUMP TO SEL. VALVE (LVE-202).....	1
16	85869	ASSY-TUBE-PUMP TO SEL. VALVE (LVE-203/204).....	1
A 17*	85653	SWITCH - DRAIN PAN	1
18	84282	VALVE-SELECTOR.....	1
--	--	(See next page for Selector Valve parts)	-
A 19	74469	VALVE - CHECK - 1/2" (Vat Fill).....	AR
20	FP01-238	FTG-3/8 NPT STR 45 DEG FLARE	1
A 21	35472	CHECK VALVE-PRESSURE	2
22	FP01-087	STREET ELBOW-3/8 NPT SS	2
23	FP02-001	NIPPLE 3/8 CLOSE.....	2
24	FP01-028	NIPPLE, CLOSE 1/2 NPT SS 1 LG	1
25	17407	CONNECTOR 1/2 MALE ELBOW	1
A 26*	MS01-572	PRIMER-LOCTITE-0.8 OZ. (for check valve threads).....	1
27*	FP01-237	PLUG - SELECTRO VALVE	AR

Recommend Parts: A=Truck Stock/B=Dist. Stock

*not shown

AR - as required (For 77523 see chart on next page)

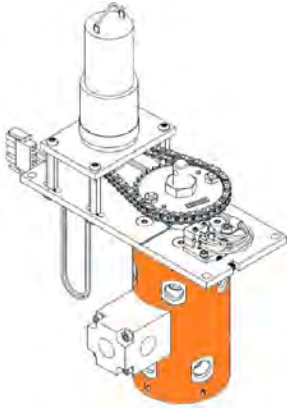

84282- VALVE-SELECTOR

*The ONLY need for the whole selector valve assembly (84282) to be used for repair would be due to possible shipping damage, fork lift, etc. or damage to the selector valve body (see the drawing below stainless steel cylinder body in orange)

84282-001

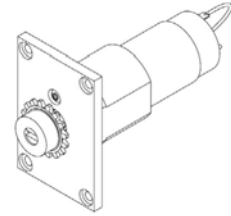

Desc.	Qty.	Req.
ASSY- SELECTOR VALVE MOTOR	1	B

84282-002

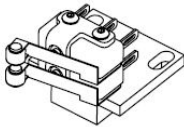

Desc.	Qty.	Req.
ASSY- SELECTOR VALVE SWITCH	1	A

84282-003



Desc.	Qty.	Req.
ASSY- SELECTOR VALVE CHAIN	1	-

84282-004

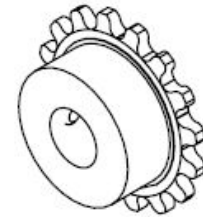

Desc.	Qty.	Req.
ASSY- SELECTOR VALVE SPROCKET	1	-

84282-005

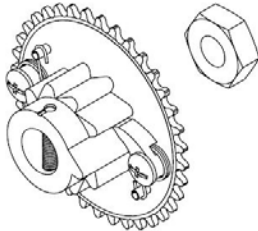

Desc.	Qty.	Req.
ASSY- SEL VALVE SPROCKET NUT	1	-

84282-006

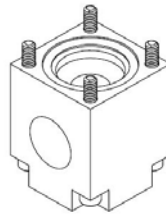

Desc.	Qty.	Req.
ASSY- SELECTOR VALVE MANIFOLD	1	-

84282-007

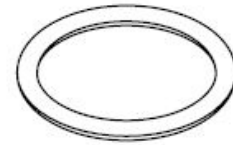

Desc.	Qty.	Req.
ASSY- SELECTOR VALVE O-RING	1	-

84282-008

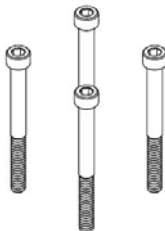

Desc.	Qty.	Req.
ASSY- MANIFOLD FASTERS	1	-

84282-009



Desc.	Qty.	Req.
ASSY- SEL V MOUNTING	1	-

84282-010



Desc.	Qty.	Req.
ASSY- SELECTOR VALVE HARN	1	-

SUCTION TUBE SELECTION CHART

VARIANT LEGEND

F = Full well - 1 full width shallow vat
S = Split well - 2 narrow shallow vats
D = Split well - 2 narrow deep vats
L = Split well - 2 narrow vats with a deep vat on left and shallow vat on right
R = Split well - 2 narrow vats with a deep vat on right and shallow vat on left

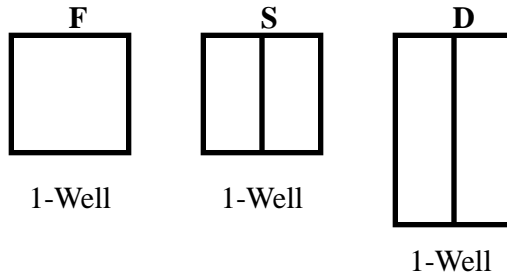

LVE-202

P/N (LENGTH)	MODEL VARIANTS			
	FF	DS LS SD SR SS	FD FR FS	DF LF SF
77523-001 (12")	1	1	1	1
77523-002 (18")	1	2	2	1
77523-003 (24")	2	2	2	2
77523-004 (30")	2	3	2	3

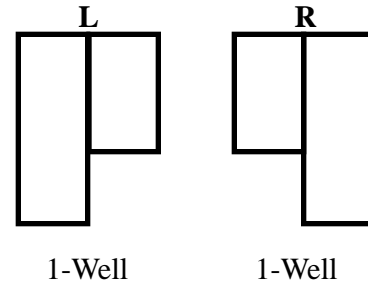

LVE-203

P/N (LENGTH)	MODEL VARIANTS					
	FFF	DSS SLS SSD SSR SSS	FSD FSR FSS	FFD FFR FFS	DSF LSF SSF	DFF LFF SFF
77523-002 (18")	1	2	2	2	1	1
77523-003 (24")	2	3	3	2	3	2
77523-004 (30")	3	3	3	3	3	3
77523-005 (36")	1	1	1	1	1	1
77523-006 (42")	--	1	--	--	1	1

LVE-204

P/N (LENGTH)	MODEL VARIANTS							
	FFFF	DSSS LSSS SSSD SSSR SSSS	FSSD FSSR FSSS	FFSD FFSR FFSS	FFFD FFFR FFFS	DSSF LSSF SSSF	DSFF LSFF SSFF	DFFF LFFF SFFF
77523-002 (18")	--	1	1	1	1	--	--	--
77523-003 (24")	2	3	3	3	2	3	2	2
77523-004 (30")	2	2	2	2	2	2	2	2
77523-005 (36")	1	1	1	1	1	1	1	1
77523-006 (42")	1	2	2	1	1	2	2	1
77523-007 (42")	1	2	1	2	1	2	2	2
77523-010 (54")	1	1	1	--	1	1	1	1

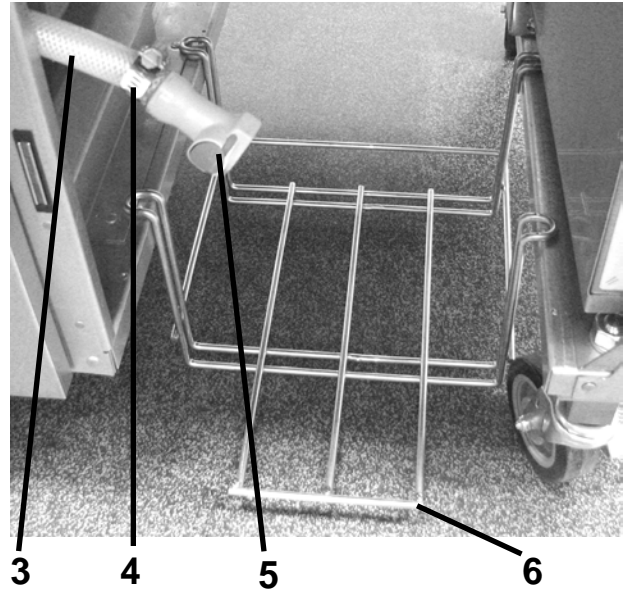
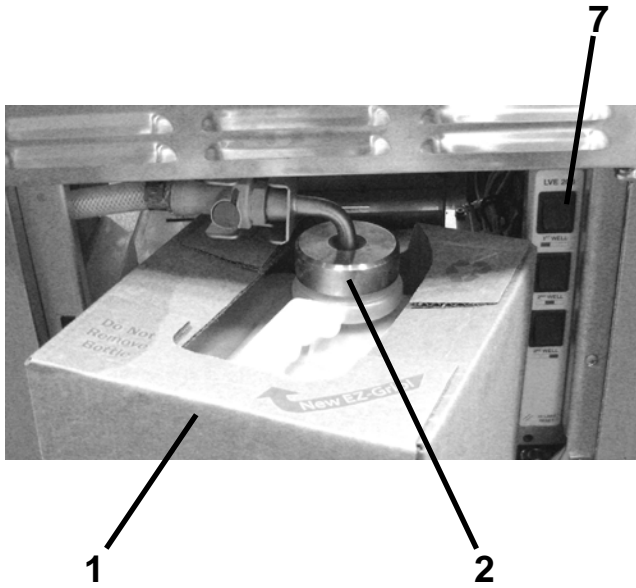

Item No.	Part No.	Description	Quantity
1	03617	ACCESSORY-JUG-AUTO TOP OFF (EMPTY).....	1
B 2	85738	ASSY-JIB TUBE & QUICK DISC.....	1
B 2	151694	ASSY-RUSSIAN JIB TUBE	1
B 2	85737	ASSY-INT'L. JIB TUBE & QUICK DISC	1
A 2*	MS01-561	O-RING - JIB TUBE	1
B 2*	FP05-017	DISCONNECT-QUICK-3/8"	1
B 3	89622-001	HOSE	1
4	MS01-297	CLAMP-HOSE	2
B 5	FP05-016	DISCONNECT-QUICK-1/2"	1
6	83539	WELD ASSY - JIB SHELF	1
6	87189	WELD ASSY - JIB SHELF (Singapore only)	1
6	96441	RAISED JIB SHELF	1
A 7	84987	SWITCH - MOMENTARY SPLASH PROOF.....	3

Recommend Parts: A=Truck Stock/B=Dist. Stock
*not shown

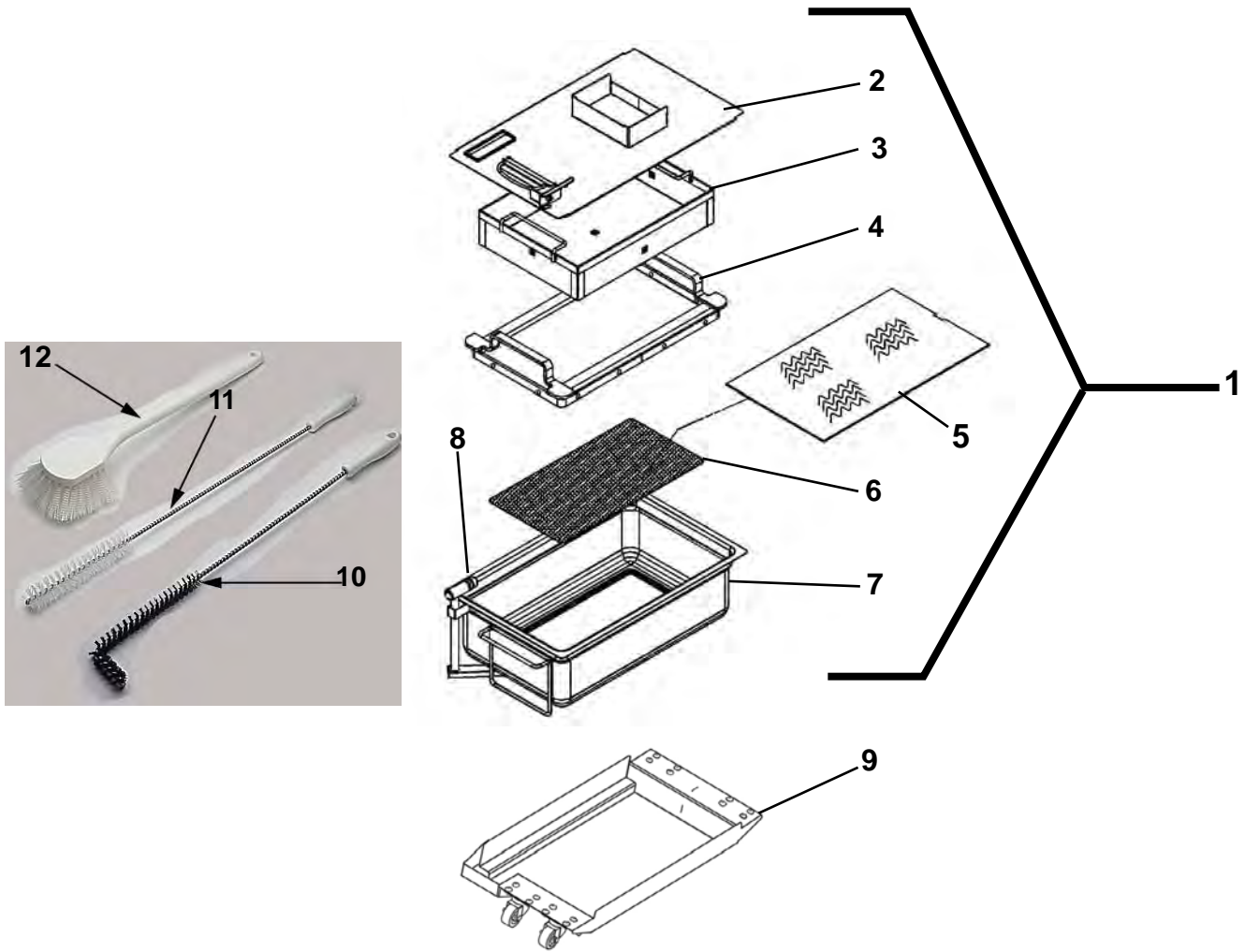

Filter Pan Assembly & Cleaning Brushes

Item No.	Part No.	Description	Quantity
1	84286	ASSY - DRAIN PAN - LVE	1
2	85650	ASSY-DRAIN PAN COVER.....	1
3	85507	WELD ASSY-CRUMB CATCHER	1
4	85503	WELD ASSY-FILTER WEIGHT	1
5	03190-054	McD's FILTER KIT (not supplied by Henny Penny)..... (includes fryer cleaner, 30 filter pads, & green cleaner pads)	1
6	85519	FILTER-SECTION	1
7	84652	WELD ASSY-DRAIN PAN.....	1
A 8	86349	O-RING-PICKUP TUBE.....	3
9	85584	ASSY-DRAIN PAN DOLLY	1
9	19004	CASTER - FILTER PAN	4
9	NS04-005	LOCKNUT	16
9	SC01-009	SCREW.....	16
B 10	12126	BRUSH - BLACK L.....	1
B 11	12112	BRUSH - STRAIGHT WHITE	1
B 12	12116	BRUSH - FRYER - LONG HANDLE	1

Recommend Parts: A=Truck Stock/B=Dist. Stock

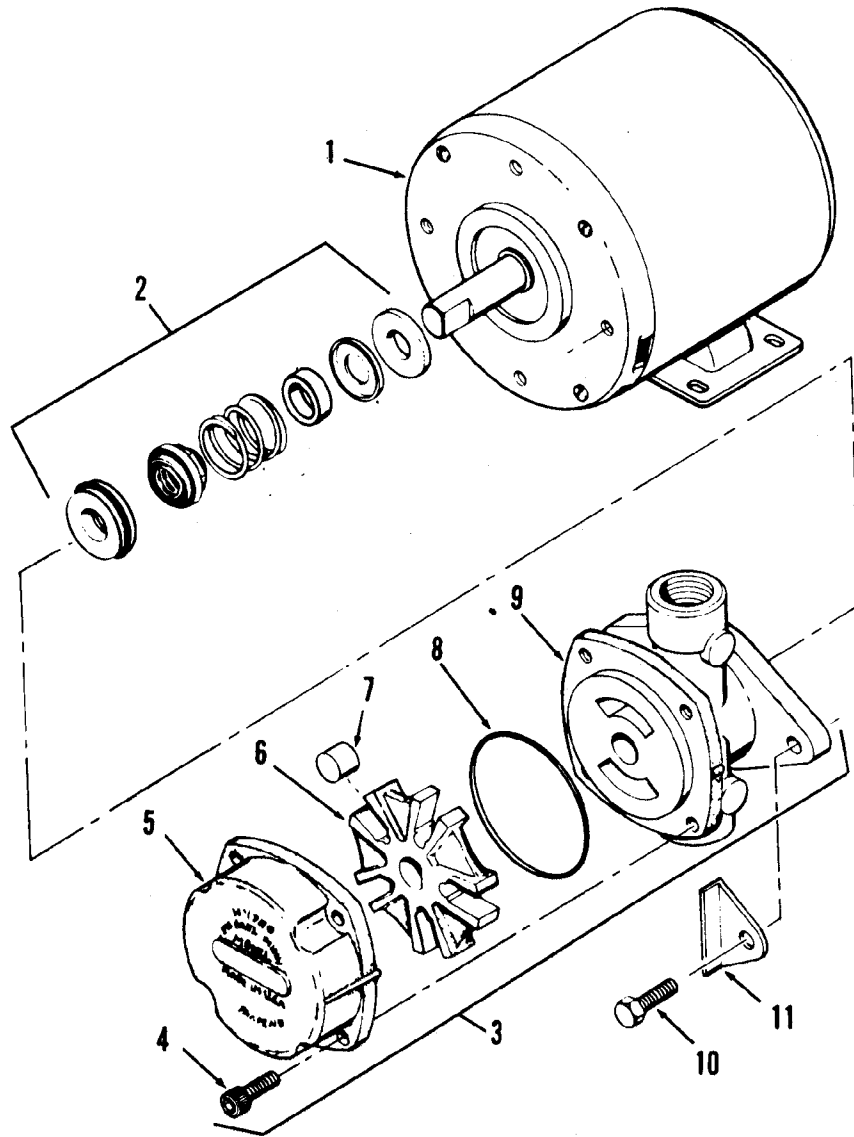

Filter Motor and Pump

Item No.	Part No.	Description	Quantity
A 1	67583	MOTOR, 1/2 HP - 60 Hz	1
A 1	92850	MOTOR, 1/2 HP - 50 Hz - CE.....	1
A 2	17476	SEAL KIT	1
B 3	17437	PUMP ASSEMBLY	1
4	SC01-132	SCREW, Pump Cover	1
5	17451	COVER, Pump.....	1
B 6	17447	ROTOR, Pump.....	1
A 7	17446	ROLLER, Pump.....	5
A 8	17453	O-RING.....	1
9	17454	BODY, Pump	1
10	SC01-026	SCREW, Pump Shield.....	1
11	17456	SHIELD, Pump.....	2

Recommend Parts: A=Truck Stock/B=Dist. Stock

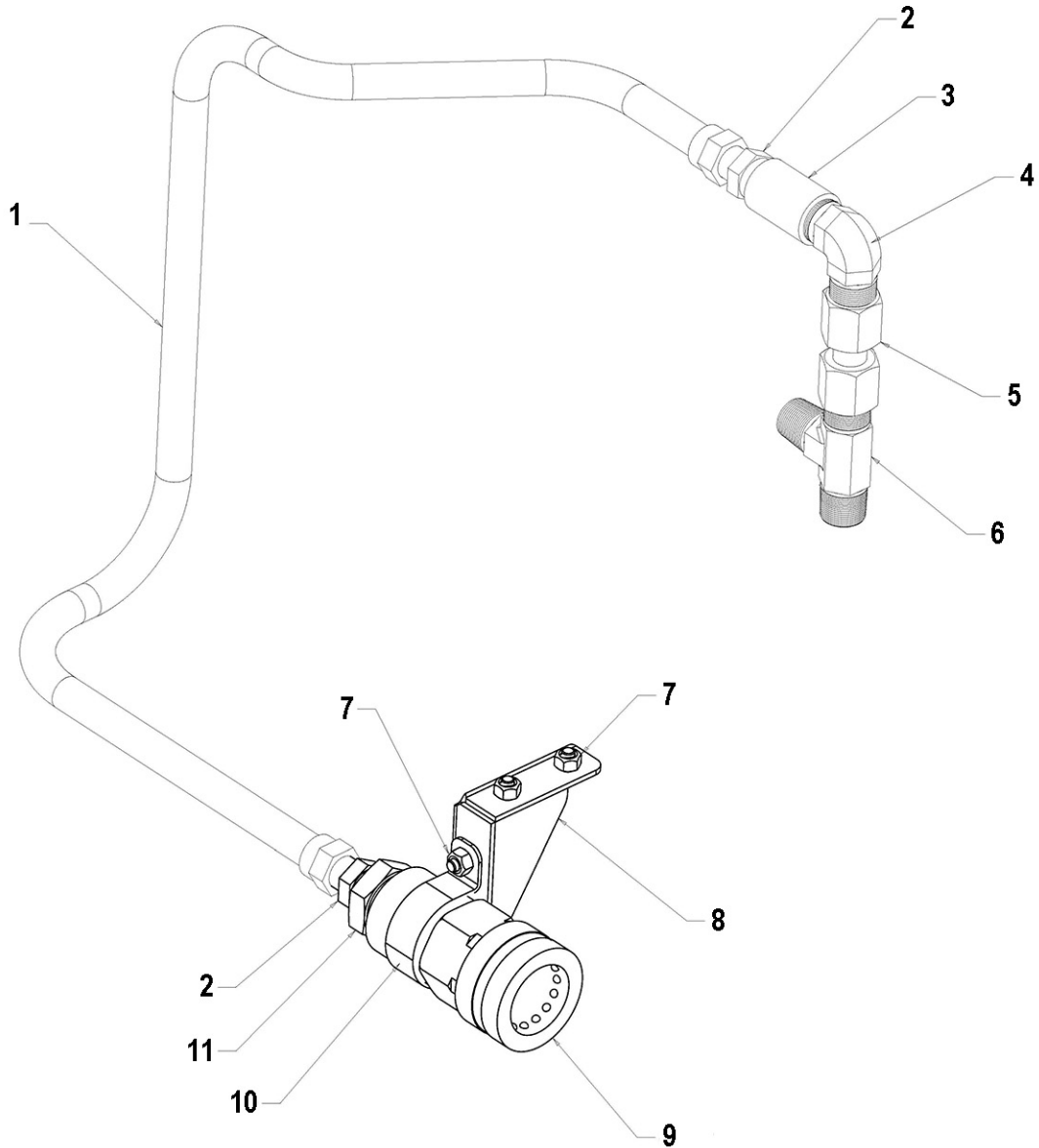

Oil Disposal Plumbing-France

Item No.	Part No.	Description	Quantity
1	77523-004	TUBE-SUCTION-30IN-FLEXIBLE.....	1
2	FP01-242	FITTING-1/2 NPT M TO 45 FLARE M	2
3	FP01-066	COUPLING 1/2 NPT SS	1
4	17407	CONNECTOR 1/2 MAIL ELBOW	1
5	84288	ASSY-PLUG & PLAY (TO PUMP INLET).....	1
6	FP01-245	FITTING-PIPE BRANCH TEE-MALE.....	1
7	NS04-005	1/4-20 HEX NUT, LOCKING, ZINC.....	4
8	86685	STUD ASSY-FRENCH DRAIN MTG BRKT	1
9	80752	FITTING-QUICK COUPLE FEMALE	1
10	86690	CLAMP-DRAIN TUBE	1
11	FP01-241	FITTING-REDUCER-1 NPT M X 1/2 NPT F.....	1

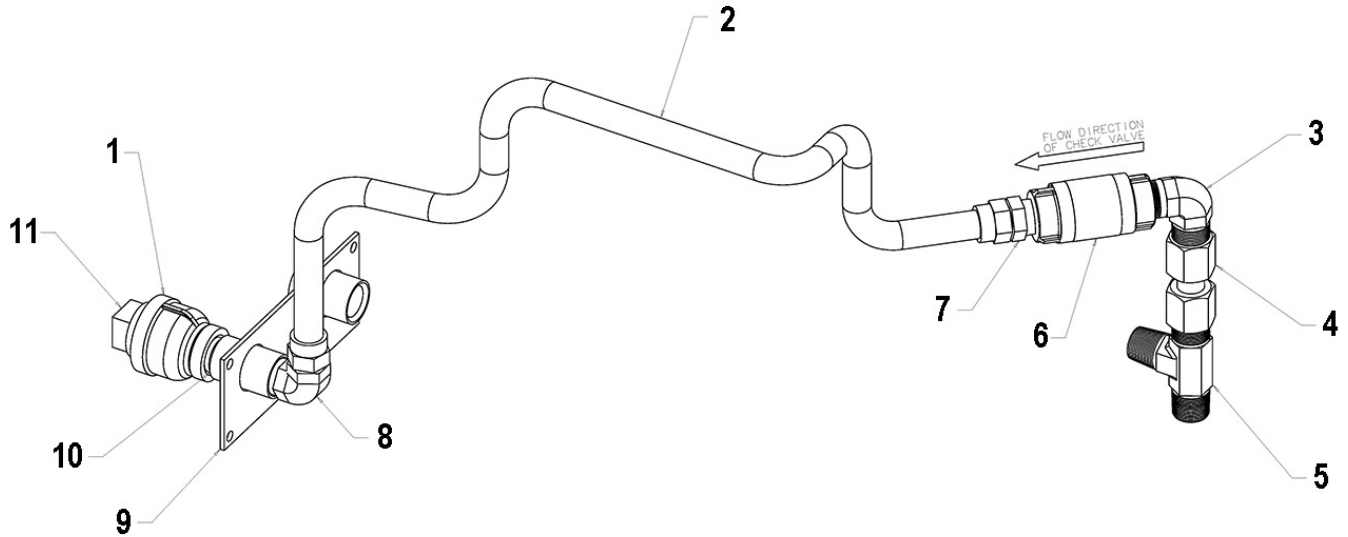

Oil Disposal Plumbing-Australia

Item No.	Part No.	Description	Quantity
1	FP01-217	COUPLE-REDUCE 1 F X 1/2F BI	1
2	77523-004	TUBE-SUCTION-30 IN-FLEXIBLE.....	1
3	17407	CONNECTOR 1/2 MAIL ELBOW	1
4	84288	ASSY-PLUG & PLAY (TO PUMP INLET).....	1
5	FP01-245	FITTING-PIPE BRANCH TEE-MALE.....	1
6	74469	VALVE-1/2 CHECK.....	1
7	FP01-242	FITTING-1/2 NPT M TO 45 FLARE M	1
8	FP01-205	ELBOW-1/2 IN NPT MALE 45 FLARE	1
9	85701	WELD ASSY-RTI OIL CONNECTION	1
10	FP01-023	NIPPLE - 1/2 INCH CLOSE BLACK	1
11	FP01-218	PLUG-1 PIPE-BI	1

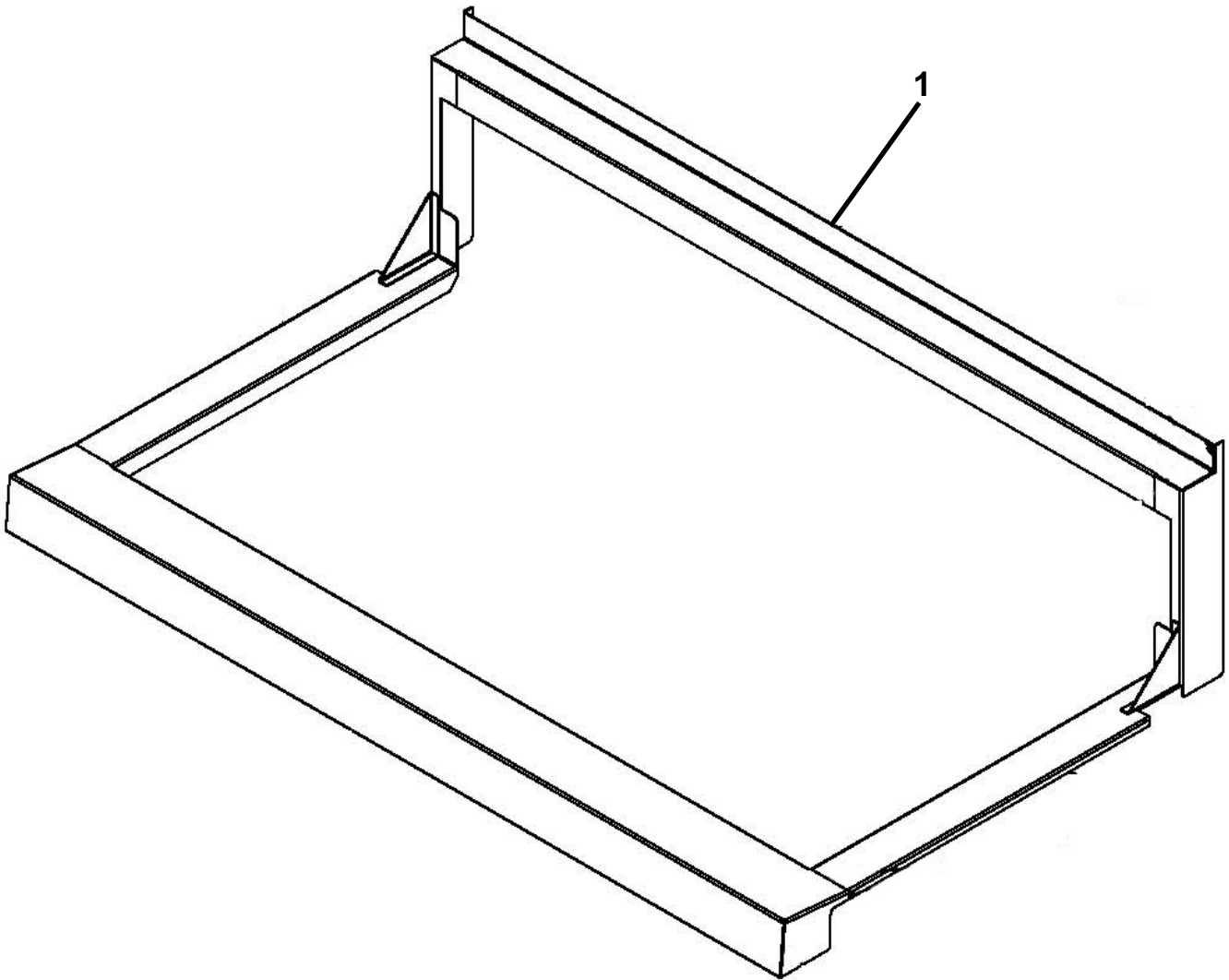

Fry Cap

Item No.	Part No.	Description	Quantity
1	03618	ACCESSORY-FRY CAP - LVE-202	1
1	03619	ACCESSORY-FRY CAP - LVE-203	1
1	03620	ACCESSORY-FRY CAP - LVE-204	1