



HENNY PENNY

Engineered to Last

Henny Penny

Split Vat & Full Vat

Open Fryers – Gas

Model LVG-202

Model LVG-203

Model LVG-204

TECHNICAL MANUAL

TABLE OF CONTENTS

Section		Page
Section 1.	TROUBLESHOOTING.....	1-1
	1-1 Introduction.....	1-1
	1-2 Safety.....	1-1
	1-3 Troubleshooting.....	1-2
	1-4 Error Code Table.....	1-7
Section 2.	INFO, FILTER & TEMP BUTTON STATS.....	2-1
	2-1 INFO Button Stats.....	2-1
	2-2 FILTER Button Stats.....	2-1
	2-3 TEMP Button Stats.....	2-1
	2-4 HP Info Mode.....	2-2
Section 3.	LEVEL 1 PROGRAMMING.....	3-1
	3-1 Modifying Product Settings.....	3-1
	3-2 AIF Clock.....	3-3
	3-3 Deep Clean Mode.....	3-4
	3-4 Fryer Setup.....	3-5
Section 4.	LEVEL 2 PROGRAMMING.....	4-1
	4-1 Advanced Product Settings.....	4-1
	4-2 E-Log (error code log).....	4-2
	4-3 Passwords.....	4-3
	4-4 Alert Tone (and volume).....	4-3
	4-5 Filter After.....	4-4
	4-6 Filter Time.....	4-4
Section 5.	LEVEL 3 PROGRAMMING.....	5-1
	5-1 Additional Advanced Product Settings.....	5-1
	5-2 Special Programming.....	5-2
	5-3 Clock Set.....	5-7
	5-4 Data Comm & Heat Control.....	5-7
	5-5 Tech Mode.....	5-8
	5-6 Stats Mode.....	5-13
Section 6.	INFORMATION MODE.....	6-1
	6-1 Info Mode.....	6-1
Section 7.	MAINTENANCE SECTION.....	7-1
	7-1 Preventive Maintenance.....	7-1
	7-2 Maintenance Hints.....	7-1
	7-3 Complete Control Replacement.....	7-2
	7-4 Power Switch Replacement.....	7-2
	7-5 Burner Tube Removal.....	7-3
	7-6 Pilot Replacement.....	7-3

Section 7.	MAINTENANCE SECTION (Continued)	
7-7	High Limit Thermocouple.....	7-4
7-8	High Limit Control.....	7-5
7-9	Probe Replacement.....	7-6
7-10	Back Shroud Removal.....	7-6
7-11	Blower Replacement.....	7-7
7-12	Vacuum Switch Replacement.....	7-7
7-13	JIB Pump Replacement.....	7-8
7-14	Selector Valve Drive Motor Replacement.....	7-9
7-15	Gas Valve Replacement.....	7-12
Section 8.	PARTS SECTION	
8-1	Introduction.....	8-1
8-2	Genuine Parts.....	8-1
8-3	When Ordering Parts.....	8-1
8-4	Prices.....	8-1
8-5	Delivery.....	8-1
8-6	Warranty.....	8-1
8-7	Recommended Spare Parts for Distributors.....	8-1
Apenndix A A-1	Wiring Diagrams & Scematics.....	A-1

Technical Data for CE Marked Products

Nominal Heat Input: (Net)	Natural (I2H) = 19,8 kW (67,560 Btu/h) Natural (I2E) = 19.8 kW (67,560 Btu/h) Natural (I2E+) = 19.8 kW (67,560 Btu/h) Natural (I2L) = 19.8 kW (67,560 Btu/h) Natural (I2HS) = 19.8 kW (67,560 Btu/h) Liquid Propane (I3P) = 19,8 kW (67,560 Btu/h) Liquid Propane/Butane (I3B/P) = 19,8 kW (67,560 Btu/h)
Nominal Heat Input: (Gross)	Natural (I2H) = 21,98 kW (75,000 Btu/h) (79.13 MJ/h) Natural (I2E) = 21,98 kW (75,000 Btu/h) Natural (I2E+) = 21,98 kW (75,000 Btu/h) Natural (I2L) = 21,98 kW (75,000 Btu/h) Natural (I2HS) = 21,98 kW (75,000 Btu/h) Liquid Propane (I3P) = 21,98 kW (75,000 Btu/h) (79.13 MJ/h) Liquid Propane/Butane (I3B/P) = 21,98 kW (75,000 Btu/h) (79.13 MJ/h)
Supply Pressure:	Natural (I2H) = 20 mbar (2.0 kPa) Natural (I2E) = 20 mbar Natural (I2E+) = 20/25 mbar Natural (I2L) = 25 mbar Natural (I2HS) = 25 mbar Liquid Propane (I3P) = 30/37/50 mbar (3.0/3.7/5.0 kPa) Liquid Propane/Butane (I3B/P) = 30/50 mbar
Test Point Pressure:	Natural (I2H) = 8.7 mbar (.87 kPa) Natural (I2E) = 8,7 mbar Natural (I2E+) = N/A Natural (I2L) = 8.7 mbar Natural (I2HS) = 8.7 mbar Liquid Propane (I3P) = 25 mbar (2.5 kPa) Liquid Propane/Butane (I3B/P) = 30/50 mbar (3.0/5.0 kPa)
Injector Size:	Natural (I2H) = 2.08 mm Natural (I2E) = 2.08 mm Natural (I2E+) = 1.70 mm Natural (I2L) = 2.30 mm Natural (I2HS) = 2.30 mm Liquid Propane/Butane (I3B/P) = 1.30 mm Liquid Propane (I3P) *30 mbar = 1.18 mm Liquid Propane (I3P) *50 mbar = 1.04 mm

This appliance must be installed in accordance with the manufacturer's instructions and the regulations in force and only used in a suitable ventilated location. Read the instructions fully before installing or using the appliance.

Noise generated from this equipment is less than 70 dB(A)

SECTION 1. TROUBLESHOOTING

1-1. INTRODUCTION

This section provides troubleshooting information in the form of an easy to read table.

If a problem occurs during the first operation of a new fryer, recheck the Installation Section of the Operator's Manual.

Before troubleshooting, always recheck the Operation Section of the Operator's Manual.

1-2. SAFETY

Where information is of particular importance or is safety related, the words DANGER, WARNING, CAUTION, or NOTE are used. Their usage is described on the next page:



SAFETY ALERT SYMBOL is used with DANGER, WARNING or CAUTION which indicates a personal injury type hazard.



NOTICE is used to highlight especially important information.



CAUTION used without the safety alert symbol indicates a potentially hazardous situation which, if not avoided, may result in property damage.



CAUTION used with the safety alert symbol indicates a potentially hazardous situation which, if not avoided, could result in minor or moderate injury.



WARNING indicates a potentially hazardous situation which, if not avoided, could result in death or serious injury.



DANGER INDICATES AN IMMINENTLY HAZARDOUS SITUATION WHICH, IF NOT AVOIDED, WILL RESULT IN DEATH OR SERIOUS INJURY.

1-3. TROUBLESHOOTING

To isolate a malfunction, proceed as follows:

1. Clearly define the problem (or symptom) and when it occurs.
2. Locate the problem in the Troubleshooting table.
3. Review all possible causes. Then, one-at-a-time work through the list of corrections until the problem is solved.
4. Refer to the maintenance procedures in the Maintenance Section to safely and properly make the checkout and repair needed.





**If maintenance procedures are not followed correctly,
injuries and/or property damage could result.**

Problem	Cause	Correction
POWER SECTION		
With power switch in ON position, the fryer is completely inoperative (NO POWER)	<ul style="list-style-type: none"> Open circuit 	<ul style="list-style-type: none"> Check to see that unit is plugged in Check the breaker or fuse at supply box Check voltage at wall receptacle Check MAIN POWERswitch; replace if defective Check cord and plug Reset transformer circuit breaker

HEATING OF SHORTENING SECTION		
Oil will not heat but lights are on No Heat error "E-22"	<ul style="list-style-type: none"> Blown fuse or tripped Faulty power switch. Faulty cord and plug Faulty drain switch Faulty PC Board High limit control switch tripped "E-10" 	<ul style="list-style-type: none"> Reset breaker or replace fuse circuit breaker at supply box or control panel Check power switch Check cord and plug Check power at receptacle Check drain switch Check control panel per maintenance section and replace as needed Allow fryer to cool for 15-20 minutes; reset high limit by pressing down & releasing raised side of the switch for the vat that is not operating; a single reset switch is found behind the door of each well; if high limit does not reset, high limit must be replaced



Problem	Cause	Correction
HEATING OF SHORTENING SECTION (Continued)		
Oil will not heat (continued)	<ul style="list-style-type: none"> • Drain valve open • Faulty temperature probe • Faulty gas valve 	<ul style="list-style-type: none"> • Close drain valve • Replace temperature probe • Check gas valve
Oil heating too slow	<ul style="list-style-type: none"> • Low gas pressure • Wire(s) loose • Burnt or charred wire connection 	<ul style="list-style-type: none"> • Have gas pressure checked • Tighten • Replace wire and clean connections
Oil overheating	<ul style="list-style-type: none"> • Programming wrong • Faulty PC board • Faulty temperature probe • Faulty gas valve 	<ul style="list-style-type: none"> • Check Temperature setting in the program mode • Replace control board if heat indicator stays on past ready temperature • Check probe calibration and replace if temperature is off ± 5 degrees • Check gas valve
OIL LEVEL SECTION		
Oil foaming or boiling over vat	<ul style="list-style-type: none"> • Water in oil • Improper or bad oil • Improper filtering • Cold zone (bottom of vats) full of crumbs • Improper rinsing after cleaning the fryer 	<ul style="list-style-type: none"> • At end of a Cook Cycle, drain and clean vat; add fresh oil • Use recommended oil • Refer to the procedure on filtering the oil.
Oil will not drain from vat	<ul style="list-style-type: none"> • Drain valve clogged with crumbs • Faulty actuator • Oil channel clogged 	<ul style="list-style-type: none"> • Open valve. using cleaning brush, force crumbs through drain valve • Replace actuator • Access the clean-out plug on the sides of the unit (see Oil Channel Clean-out Section)
Oil leaking through drain valve	<ul style="list-style-type: none"> • Obstruction in drain • Faulty drain valve 	<ul style="list-style-type: none"> • Remove obstruction • Replace drain valve

Problem	Cause	Correction
OIL LEVEL SECTION (Continued)		
Vat is under-filled	<ul style="list-style-type: none"> • Locations with RTI, the 3-way valve is stuck open • Filter pan needs cleaned • JIB is low or empty • JIB oil line is clogged or collapsed • Quick Disconnect O-ring may be worn or missing 	<ul style="list-style-type: none"> • The RTI system can be disconnected until RTI repairs the valve • Clean filter pan and change pad • Fill the JIB • Check JIB line • Check JIB Disconnect O-ring for wear or cracking. Replace if missing or torn
Bubbles in oil during entire filtering process	<ul style="list-style-type: none"> • Filter pan needs cleaned • Filter pan not completely engaged • Filter pan clogged • Damaged o-ring on filter line tube on fryer 	<ul style="list-style-type: none"> • Clean filter pan and change pad • Make sure filter pan return line is pushed completely into the receiver on the fryer • Clean pan and change pad • Change o-ring
FILTER MOTOR SECTION		
Filter motor runs but pumps oil slowly	<ul style="list-style-type: none"> • Filter line connections loose • Drain pan o-rings damaged or missing • Filter paper or pad clogged 	<ul style="list-style-type: none"> • Tighten all filter line connections • Install new o-rings • Change filter paper or pad
Filter motor will not run	<ul style="list-style-type: none"> • Thermal reset button on the rear of the pump motor is tripped <div data-bbox="548 1367 922 1493" style="text-align: center;">  </div> <p data-bbox="493 1497 943 1703">To prevent burns caused by splashing shortening, turn the unit's POWER switch to the OFF position before resetting the filter pump motor's manual reset protection device.</p>	<ul style="list-style-type: none"> • Allow time for the motor to cool. Open front door and using at least a 12 in. (305 mm) Phillip's head screwdriver, press on the thermal reset button by prying hard between the button and the door frame until button clicks <div data-bbox="984 1541 1422 1885" style="text-align: center;">  </div>

DISPLAYED PROMPT SECTION		
<p>“IS POT FILLED” filter error prompt</p>	<ul style="list-style-type: none"> • All oil did not completely return after a filter cycle • Filter pad clogged 	<ul style="list-style-type: none"> • Have manager follow prompts • Is JIB full? If not, fill JIB • Replace filter pad/clean pan.
<p>“CHECK PAN” prompt</p>	<ul style="list-style-type: none"> • Filter drain pan missing • Filter drain pan not completely engaged • Filter drain interlock switch not engaged 	<ul style="list-style-type: none"> • Find pan and install • Adjust filter drain pan position • Check drain microswitch
<p>“CHANGE FILTER PAD” prompt appears</p>	<ul style="list-style-type: none"> • Filter pad has not been changed within a 24hr time period; Main power switch was turned off during filter pad change • Drain pan microswitch stuck 	<ul style="list-style-type: none"> • Replace old filter pad with NEW filter pad with main power switch turned on. • *NOTE* 24/7 store replace filter twice a day. • Check drain microswitch

1-4. ERROR CODES

In the event of a control system failure, the digital display shows an error message. The message codes are shown in the DISPLAY column below. A constant tone is heard when an error code is displayed, and to silence this tone, press any button.

DISPLAY	CAUSE	CORRECTION
“E-4”	Control board overheating	Turn switch to OFF position, then turn switch back to ON; if display shows “E-4”, the control board is getting too hot; check the louvers on each side of the unit for obstructions
“E-5”	Oil overheating	Turn switch to OFF position, then turn switch back to ON; if display shows “E-5”, the heating circuits and temperature probe should be checked
“E-6A”	Temperature probe open	Turn switch to OFF position, then turn switch back to ON; if display shows “E-6A”, the temperature probe should be checked
“E-6B”	Temperature probe shorted checked	Turn switch to OFF position, then turn switch back to ON; if display shows “E-6B”, temperature probe should be
“E-10”	E-10A- tripped above 300F E-10B- tripped below 300F E-10C- tripped while cooking E-10D- tripped <5min. of Auto Filter E-10F- tripped during filter cycle E-10M- tripped during melt mode E-10Y- tripped <5min of “YES” to “IS THE POT FULL?” prompt	Allow fryer to cool for 15-20 minutes; reset high limit by pressing down & releasing raised side of the switch for the vat that is not operating; a single reset switch is found behind the door of each well; if high limit does not reset, high limit must be replaced 
“E-15”	Drain valve open	Clean and/or close fish vat drain valve; if clean and closed, have drain switch continuity checked
“E-18-A” “E-18-B” “E-18-C”	Left level sensor open Right level sensor open Both level sensors open	Turn switch to OFF position, then turn switch back to ON; If display still indicates a failed sensor, check the connectors at the control board; check sensor & replace, if necessary
“E-20-A” “FAN SENSOR STUCK CLOSED”	Pressure switch failure/ Wiring problem	If fan is not running, have pressure switch checked; should be open circuit, if no air pressure If fan is running, wiring error

1-4. ERROR CODES (CONTINUED)

<p>“E-20-B” “NO DRAFT” “CHECK FAN”</p>	<p>Pressure Switch failure/ hose loose Draft Fan failure/ low voltage/ Flue or hood obstruction</p>	<p>Press power button to vat off and back on again, if E-20-B persists, have pressure switch checked; should be open circuit if no air pressure; make sure hose is connected to fan and pressure switch</p> <p>Have draft fan checked; low voltage going to fan</p> <p>Check the fryer flue and hood system for obstructions</p>
<p>“E-20-D”</p>	<ul style="list-style-type: none"> Failure to ignite/ no flame sense Plugged atmospheric equalization hole in regulator cap resulting in pilot flame slowly fading 	<ul style="list-style-type: none"> Press power button to vat off and back on again, if E-20-D persists, check gas line connections; check gas shutoff valve; check ignition module; check gas valve; check flame sensor gap; check gas valve, and check ignition module wiring Clear obstruction from hole 
<p>“E-21”</p>	<p>Slow heat recovery</p>	<p>Have a certified service technician check the fryer for correct gas supply and pressure to the unit; have the gas valves checked; have unit checked for loose or burnt wires</p>
<p>“E-22” “NO HEAT”</p>	<p>Burner not igniting</p>	<p>Have gas valve and heat circuit checked</p>
<p>“E-41” , “E-46”</p>	<p>Programming failure</p>	<p>Turn switch to OFF, then back to ON; if display shows any of these error codes, re-initialize the controls; if error code persists, check control board and replace as needed</p>
<p>“E-47”</p>	<p>Analog converter chip or 12 volt supply failure</p>	<p>Turn switch to OFF, then back to ON; if “E-47” persists, replace the PC board</p>
<p>“E-48”</p>	<p>Input system error</p>	<p>Turn switch to OFF, then back to ON; have control PC board replaced if “E-48” persists</p>
<p>“E-54-C”</p>	<p>Temperature input error</p>	<p>Turn switch to OFF, then back to ON; have control PC board replaced if “E-54C” persists</p>

1-4. ERROR CODES (CONTINUED)

"E-60"	AIF PC board not communicating with control PC board	Turn switch to OFF, then back to ON; if "E-60" persists, check 1.5 amp fuse on AIF PC board on International units only; check connector between the PC boards; replace AIF PC board or control PC board if necessary
"E-62A"	Communication error	-Verify the OQM sensor wiring is correct. -Replace cable. -Replace Sensor
"E-62B"	Wrong calibration parameter	Replace OQM Sensor
"E-62C"	Shorted capacitance	Replace OQM Sensor
"E-62D"	Shorted RTD	Replace OQM Sensor
"E-62E"	Open RTD	Replace OQM Sensor
"E-62F"	Open capacitance	Replace OQM Sensor
"E-62G"	Out of range (TPM value over 35)	Replace oil and take a TPM reading, if the error is still present replace OQM sensor.
"E-70-C"	Drain valve jumper wire missing or disconnected	Have the jumper wire checked on the PC board at drain switch interlock position
"E-82A"	Selector Valve not detected	Have wiring checked between Selector Valve and AIF board
"E-82B"	Selector Valve failed	Have the "Home" switch on Selector Valve checked
"E-82C"	Selector Valve failed	Have wiring checked between the "Home" & "Position" encoder and the Selector Valve; Have Selector Valve Motor checked; Have drive chain checked
"E-82-D"	Selector Valve failed	Have the "Home" switch and the "Position" switch on Selector Valve checked
"E-83" "PRES-SURE" "TOO HIGH"	Pressure Trasducer senses too high pressure in AIF system	Check AIF system or the RTI quick-disconnect; See details below;
"E-83-A"	Pressure too high	Check AIF system in Vat #1
"E-83-B"	Pressure too high	Check AIF system in Vat #2
"E-83-C"	Pressure too high	Check AIF system in Vat #3
"E-83-D"	Pressure too high	Check AIF system in Vat #4
"E-83-E"	Pressure too high	Check AIF system in Vat #5
"E-83-J"	RTI "JIB FILL" switch ON when pressure too high	Check JIB fill valves
"E-83-R"	RTI "DISPOSE" switch ON when pressure too high	Check RTI quick-disconnect behind fryer; RTI phone no. if needed: 888-796-4997
"E-83-Z"	Unknown source	Check RTI system & JIB fill valve
"E-93-A"	24VDC tripped	Have drain actuator checked

SECTION 2. INFO, FILTER & TEMP BUTTON STATS

2-1. INFO BUTTON STATS

Recovery Information for each Vat/OQM Information



1. Press and release  and REC shows in left display and the recovery time that oil temperature went from 250°F (121°C) to 300°F (149°C) shows in the right display. For example,

REC	5:30
-----	------

 means it took 5 minutes and 30 seconds for the oil temperature to recover to 300°F (149°C) from 250°F (121°C).

- 1a. Press and release , the display will show the last TPM reading, date of the last TPM reading, and time stamp of last TPM reading (only if OQM sensor is installed and enabled).

Selected Languages



2. Press  twice and the primary language shows in the left display and the secondary language shows in right display. Press  button under either language to switch unit operation to that language.

2-2. FILTER BUTTON STATS

NOTICE

If no buttons are pressed within 5 seconds in any of stats modes, the controls revert back to normal operation.



Cook Cycles Remaining before Filtering

1. Press and release either  or  and left display shows “COOKS REMAIN” and right display shows the number of cook cycles before the next auto filter. For example,

REMA IN	3	6
---------	---	---



 means after 3 more cook cycles on the left vat, the controls ask operator if they are ready to filter or not. But, 6 more cook cycles remain on the right vat.

Time and Date

2. Press either  or  twice and time-of-day and date shows in the displays.

2-3. TEMP BUTTON STATS

Filter Pad Usage

3. Press either  or  three times and number of hours the present filter has been used is shown in the displays.

Actual Oil Temperature

1. Press  and the actual oil temperature shows in the display, for each vat.

Set-point Temperature

2. Press  twice and SP shows in the display, along with the set-point (preset) temperature of each vat.

2-4. HP INFO MODE

Cook Cycles Remaining before Filtering

Press and release both  and  at the same time to

enter HP Info Mode. You can view the following option in HP Info Mode:



1. E-Log
2. Last Load
3. Daily Stats
4. Review Usage
5. Inputs HDE (to check: high limit, drain switch jumper, and tilt switch)
6. Outputs S_H (saftey contactor / heat contactor)
7. Oil Temperature
8. CPU Temp
9. Communication OQM Sensor
10. Analog
11. Activity Log
12. Oil Levels (see if low level sensing temperature difference between probes).
13. Pumps and Valves
14. AIF Info (check for drain pan recognition: Left F button 1X and down arrow 2X).
15. Print Report to USB
16. Remove USB
17. Oil Quality Support
 - a. Software Version (SVN); hardware (HVN)
 - b. Serial Number
 - c. RTC Date
 - d. RTC Time
 - e. Vat-1
 - f. Vat-2
 - g. Vat-3
 - h. Vat-4
 - i. Vat-5
 - j. Vat-6
 - k. Vat-7
 - l. Vat-8

SECTION 3. LEVEL 1 PROGRAMMING



Level 1 contains the following:

- Modify product settings
- Set the AIF clock for products
- Perform the Deep Clean procedure
- Fryer Setup Mode

3-1. MODIFYING PRODUCT SETTINGS

1. Press and hold  and  buttons until LEVEL - 1 shows in the display, followed by ENTER CODE.
2. Enter code 1, 2, 3, 4 (first 4 product buttons).
“PRODUCT” and “SELECTN” show in the displays.
3. Press right $\sqrt{}$ button and ‘SELECT PRODUCT’ and “-P 1-” (ex: NUGGETS) show in the displays.

Change Product Names

4. Use the \blacktriangleleft and \blacktriangleright buttons to scroll through 40 products, or press desired product button .
5. Press right $\sqrt{}$ button and the product (ex: NUGGETS) shows in left display and “MODIFY”, and “YES NO” shows in right display. Press $\sqrt{}$ button to change this product, or press the X button to choose another product.
6. If $\sqrt{}$ button was pressed, press and release a product button and the flashing letter changes to the first letter under the product button that was pressed. For example, if  pressed, the flashing letter changes to an “A”.

Press same button again and the flashing letter changes to a “B”. Press it again and the flashing letter changes to a “C”. Once desired letter shows in the display, press \blacktriangleright button to continue to the next letter and repeat the procedure.

Press and hold the right X button to exit Program Mode, or press \blacktriangledown button to continue on to “1. COOK TIME”.

To Change Times and Temperatures

7. Press \blacktriangledown button until “COOK TIME” shows in display, and then use product buttons  to change the time in minutes and seconds, to a maximum of 59:59.

3-1. MODIFYING PRODUCT SETTINGS (CONTINUED)

8. Press and release ▼ button and “TEMP” shows in the display, along with the preset temperature on the right side of the display.

Press the product buttons  to change the temperature. The temperature range is 190°F (88°C) to 380°F (193°C).

Cook ID Change

9. Press ▼ button until “COOK ID” shows in the display along with the product ID. For example, NUG would be the ID for nuggets. Use the product buttons to change the ID, following the same procedure as Step 6 above.

Alarms (Duty 1 & 2)

10. Press ▼ button until “DUTY 1” shows in left display, and an alarm time in the right display. Press the product buttons  to set an alarm.

Ex., If a Cook Cycle was set at 3 minutes, and an alarm was to go off after 30 seconds into the Cook Cycle, “0:30” would be set in the display at this time. When the timer counts down to 2:30 the alarm sounds.

After alarm time is set, press ▼ button and “DUTY 2” shows in display, and a second alarm can be programmed.

Quality Timer

11. Press ▼ button until QUAL TMR shows in display along with preset holding time. Press product buttons to adjust  hold time (2 hrs., 59 min. max.).

AIF Disable

12. Press ▼ button until “AIF DISABLE” shows in display along with “YES” or “NO”. Using ◀ and ▶ buttons change the display to “YES” if that product is to not be included in the automatic intermittent filtration operation, or “NO” if it is to be included.

Assign Button

13. Press ▼ button until “ASSIGN BTN” shows in the display, along with the product (ex: NUGGETS). If this product already has a product button assigned to it, that LED will be lit. To assign other product buttons to that product, press and hold the product button for 3 seconds and that LED stays lit. To remove a product from a button, press and hold the product button with a lit LED and the LED goes out.



3-2. AIF CLOCK

This feature allows controls to be set for periods of the day that block the automatic “Filter Now” prompts. For example, the controls could be set not interrupt with “Filter Now” prompts during the lunch rush, and during the supper rush. But, if filtering is desired during this time, press and hold a  button to access the filter menu.

Each AIF Blocking period is defined by a start time (a time of day, XX:XX A, etc) and a duration in minutes.

Weekdays M-F are all grouped together. Up to four different AIF blocking periods may be programmed throughout the day for Monday - Friday. (All days share the same settings.)

A separate set of four blocking periods may be programmed for Saturdays, and a final set of four blocking periods may be programmed for Sundays.

1. Press and hold  and  buttons until LEVEL - 1 shows in the display, followed by ENTER CODE.
2. Enter code 1, 2, 3, 4 (first 4 product buttons). “PRODUCT” and “SELECTN” show in the displays.
3. Press ▼ button once and “AIF CLOCK” show in displays.
4. Press √ button and use ◀ and ▶ buttons to scroll through “ENABLE” and “DISABLE” and then press √ button again to select one.
5. If “ENABLE” is chosen, then ▲ and ▼ buttons can be used to scroll through following list of blocking periods:

Left Display	Right Display
M-F 1	XX:XX A XX
M-F 2	XX:XX A XX
M-F 3	XX:XX A XX
M-F 4	XX:XX A XX
SAT 1	XX:XX A XX
SAT 2	XX:XX A XX
SAT 3	XX:XX A XX
SAT 4	XX:XX A XX
SUN 1	XX:XX A XX
SUN 2	XX:XX A XX
SUN 3	XX:XX A XX
SUN 4	XX:XX A XX

3-2. AIF CLOCK
(CONTINUED)

In 12-hour clock mode, there are three items on each line: the start time “XX:XX”, the A or P (am/pm) setting, and the “XX” duration. Use the ◀ and ▶ buttons to set these items, which flashes when the item is selected.

To set a new start time setting, use the product buttons,



to enter the new value.

Press the ▶ button to step over to the AM/PM setting. The A or P can be toggled by pressing the ‘0’ product button.

Press the ▶ button again to step over to the duration value (in minutes). Enter a new value using the product buttons,



In 24-hour clock mode, there are only two items on each line: the time (XX:XX) and the duration (XX). Again, the ◀ and ▶ buttons step you between these items.



Press the right-side X button to exit out of AIF Clock programming mode.

3-3. DEEP CLEAN MODE

This procedure allows a thorough cleaning of the vat by removing caramelized oil from vat. See Section 4-3 in the Operator’s Manual for complete set of instructions.

3-4. FRYER SETUP

This mode has the same settings as seen upon initial start-up of the fryer.

1. Press and hold  and  buttons until LEVEL - 1 shows in the display, followed by ENTER CODE.
2. Enter code 1, 2, 3, 4 (first 4 product buttons). “PRODUCT” and “SELECTN” show in the displays.
3. Press ▼ button 3 times and “FRYER SETUP” show in the displays.
4. Press √ button and *SETUP* *MODE* shows in displays, followed by, “LANGUAGE” on the left display, “ENGLISH” on the right display.

Use ◀ or ▶ buttons to change the operation display to, “FRANCAIS”, “CAN FREN”, “ESPANOL”, “PORTUG”, “DEUTSCHE”, “SVENSKA”, “РУССКИЙ”.

Press ▼ to continue with other set-up items which include:

- ZONE - USA or NON-USA
- TEMP FORMAT - °F or °C
- TIME FORMAT - 12-HR OR 24-HR
- ENTER TIME - Time of day (use product buttons to change)
- ENTER TIME - AM OR PM
- DATE FORMAT - US OR INTERNATIONAL
- ENTER DATE - Today’s date (use product buttons to change)
- FRYER TYPE - GAS or ELEC
- VAT TYPE - FULL OR SPLIT
- DISPOSE BULK OIL - YES/NO (BULK has RTI system)
- SUPPLY BULK OIL - YES/NO (BULK has RTI system)
- DAYLIGHT SAVING TIME - 1.OFF; 2.US (2007 & after); 3.EURO; 4.FSA (US before 2007)
- OIL QUALITY ENABLED (yes or no)
- TPM WARN (value can be set to 0% - 40%)
- TPM MAX (value can be set to 0% - 40%)



Unless otherwise indicated, use ◀ or ▶ to change settings.

SECTION 4. LEVEL 2 PROGRAMMING



Used to access the following:

- Advanced changes to product settings
- Error code log
- Password programming
- Alert Tone/Volume
- No. of cook cycles before filter is suggested
- Automatic filter time



4-1. ADVANCED PRODUCT SETTINGS

1. Press and hold  and  buttons until LEVEL - 2 shows in the display, followed by ENTER CODE.
2. Enter code 1, 2, 3, 4 (first 4 product buttons). “PROD” and “COMP” show in the displays.
3. Press right √ button and ‘SELECT PRODUCT’ and “-P 1-” show in the displays.
4. Use the ◀ and ▶ buttons to scroll through 40 products, or press the desired product button.
5. Press right √ button and product (ex: NUGGETS) shows in the left display and “MODIFY” “YES NO” shows in the right display. Press the √ button to change this product, or press the X button to choose another product.

>Load Compensation, Load Compensation Reference, Full Heat, PC Factor<

6. If √ button was pressed, “LD COMP” shows in the display along with the load compensation value. This automatically adjusts the time to account for the size and temperature of the cooking load. Press the product buttons  to change this value of 0 to 20.
7. Press ▼ button until “LCMP REF” shows in the display along with the load compensation average temperature. (if load compensation is set to “OFF”, then “_ _ _” shows in display and setting cannot be programmed) This is the average cooking temperature for each product. The timer speeds up at temperatures above this setting and slows down at temperatures below this setting. Press the product buttons  to change this value.



**4-1. ADVANCED PRODUCT
SETTINGS (CONTINUED)**

8. Press ▼ button until “FULL HT” shows in display along with full heat value in seconds, which means heat is on as soon as a timer button is pressed, for a programmed length of time. Press product buttons  to change this value of 0 to 90 seconds.
9. Press ▼ button until “PC FACTOR” shows in display along with the proportional temperature, which helps keep the oil from over-shooting the setpoint temperature. Press product buttons  to change this value of 0 to 50 degrees.

NOTICE

- Use ▲ button to go back to previous menu items.
- Press X button when finished with the current product, to return to the PRODUCT SELECTN step.
- Press X button a second time to exit PROD COMP mode.

**4-2. E-LOG
(ERROR CODE LOG)**



1. Press and hold  and  buttons until LEVEL - 2 shows in the display, followed by ENTER CODE.
2. Enter code 1, 2, 3, 4 (first 4 product buttons). “PROD” and “COMP” show in the displays.
3. Press ▼ button and “E-LOG” shows in the display.
4. Press right √ button and “A” plus the present date & time flashes on the display, along with “*NOW*”.
5. Press ▼ and if an error was recorded, “B” and date, time, and error code information shows in display. This is the latest error code that the controls recorded.
6. Press ▼ and the next latest error code information can be seen. Up to 10 error codes (B to K) can be stored in the E-Log Section.

NOTICE



Press and hold the right √ button to view a brief description of the error.

4-3. PASSWORDS

The 4-digit passwords can be changed for access to Set-Up, Usage, Level 1, Level 2, & Get Mgr.)

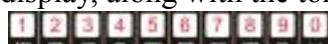

1. Press and hold  and  buttons until LEVEL - 2 shows in the display, followed by ENTER CODE.
2. Enter code 1, 2, 3, 4 (first 4 product buttons). “PROD” and “COMP” show in the displays.
3. Press ▼ button twice and “PASSWORD” shows in the display.
4. Press right √ button and “SET UP” shows in display. The Set up password can be changed at this time, or press ▼ once to change the USAGE password, twice for LEVEL 1 password, 3 times for LEVEL 2 password, or 4 times for GET MGR password. And then, follow instructions below.
5. If the password for Set Up Mode (for example) is to be changed, press right √ button and “MODIFY? “YES NO” shows in the display. Press right √ button to change the 4-digit password for the Set Up Mode, using the product buttons 
6. Once new password is entered, “CONFIRM PASSWORD” shows in the display. Press √ button to confirm, or press X to choose another password.

4-4. ALERT TONE (AND VOLUME)

1. Press and hold  and  buttons until “LEVEL - 2” shows in the display, followed by “ENTER CODE”.
2. Enter code 1, 2, 3, 4 (first 4 product buttons). “PROD” and “COMP” show in the displays.
3. Press ▼ button 3 times and “ALERT TONE” shows in the display.
4. Press right √ button and “VOLUME” shows in display, along with volume value. Use the product buttons  to set volume from 1 (softest) to 10 (loudest).
5. Once volume is set, press √ button and “TONE” shows in display, along with the tone value. Use the product buttons  to set tone from 50 to 2000 Hz.
6. Press X to exit Alert Tone Mode.



4-5. FILTER AFTER

The number of cook cycles between filtering the oil can easily be programmed for all products.

1. Press and hold  and  buttons until LEVEL - 2 shows in the display, followed by ENTER CODE.
2. Enter code 1, 2, 3, 4 (first 4 product buttons). “PROD” and “COMP” show in the displays.
3. Press ▼ button 4 times and “FILR AFTR” shows in the left display.
4. Use the product buttons  to set the number to cook cycles between filtering procedures from 0 to 99.
5. Once set, press ✓ button to confirm.

4-6. FILTER TIME

The length of time the fryer remains idle between cook cycles before the controls suggest filtering.

1. Press and hold  and  buttons until LEVEL - 2 shows in the display, followed by ENTER CODE.
2. Enter code 1, 2, 3, 4 (first 4 product buttons). “PROD” and “COMP” show in the displays.
3. Press ▼ button 5 times and “FILR TIME” shows in the left display (hours:minutes).
4. Use the product buttons  to set a time between cook cycles from 0 to 18:00 hours.

For example, if “5:00” is programmed in the right display, if the vat was not used for 5 hours after a cook cycle, the controls would display “FILR NOW?” “YES NO”.



5. Once set, press ✓ button to confirm.

SECTION 5. LEVEL 3 PROGRAMMING





Used to access the following:

- TECH RESETS-Reset Recovery Faults/Passwords to defaults
- SPCL PROG-Program filter control parameters and other items
- CLOCK SET-Set the time-of-day clock / calendar
- DATA COMM-Data Communications, LonWorks, MMC, etc.
- HEAT CTRL-Program heat algorithm control parameters
- TECH MODE-Control of outputs, display & button tests, etc.
- STATS MODE-Review, reset operating stats, diagnostic logs, etc

5-1. ADDITIONAL ADVANCED PRODUCT SETTINGS

1. Press and hold  and  buttons until LEVEL - 3 shows in the display, followed by ENTER CODE.
2. Enter code 1, 1, 2, 2, 1, 1, 2, 2 (first 2 product buttons), and “A. TECH” & “RESETS” show in the displays.

>Tech Resets<

3. Press right  button and “RECOVERY FAULTS” shows in left display. Right display shows “CLR” and the number of recovery error recorded. Press  button to reset the number to “0”.
4. Press  button and “ALL PASSWORDS RESET” shows in left display. Press  button to reset all passwords set in the controls.

NOTICE

- Use  button to go back to previous menu items.
- Press X button when finished with the current item, to return to the main menu.
- Press X button a second time to exit Level 3 programming.

5-2. SPECIAL PROGRAMMING

The Special Program Mode is used to set more detailed programming, such as:

- SP-1** • ZONE - USA or Non-USA (default setpoints)
- SP-2** • System Initialization
- SP-3** • 2nd Language: English, French, Candian-French, German, Spanish, Portuguese, Swedish, Russian, & NONE
- SP-4** • 2nd Volume
- SP-5** • Quick Configuration - CHKN+FISH; FF/HBR; CHKN; EMPTY
- SP-6** • Polish Duration - X:XX M:SS
- SP-7** • Drain Valve - NORMAL or MANUAL
- SP-8** • Edit S/N (Serial Number)
- SP-9** • Decal Layout - UP/DOWN or DOWN/UP
- SP-10** • Recovery Test Limit - XXX SEC
- SP-11** • Melt Cycle Select - 1.LIQUID; 2.SOLID
- SP-12** • Change Pad Reminder Time - XX HRS
- SP-13** • Pan Out = Pad Changed Time - XXX SEC
- SP-14** • Auto-Fill Enabled? - YES; NO
- SP-15** • Auto-Fill Cycle Time? - XXX SEC
- SP-16** • Auto-Fill Check JIB - XXX CNT
- SP-17** • Oil Full If Delta Above... - XX°F or C
- SP-18** • Oil Low If Delta Below... - XX°F or C
- SP-19** • Heat Allowed During Fill? - HEAT OK; NO HEAT
- SP-20** • Always Ask "IS POT FILLED?" - YES; NO
- SP-21** • Oil Drain Time - XXX SEC
- SP-22** • Oil WashTime - XXX SEC
- SP-23** • Oil Rinse Time - XXX SEC
- SP-24** • Oil Type Fill Time - XXX SEC
- SP-25** • Repeat Fill Time - XXX SEC
- SP-26** • RTD Air Cooling - X.XX°/SC
- SP-27** • RTD Cold Oil Surround - X.XX°/SC
- SP-28** • RTD Hot Oil Surround - X.XX°/SC
- SP-29** • Temp. Probe x Above Min. - XXX °F or C
- SP-30** • x Above Min. Hit Limit - XXX CNT
- SP-31** • Level RTD Air Cooling - X.XX°/SC
- SP-32** • Level RTD Oil Surround - X.XX°/SC
- SP-33** • New Pad-Max. Fill Time - XXX SEC
- SP-34** • Old Pad-Max. Fill Time - XXX SEC
- SP-35** • Fill To Top Time - XXX SEC
- SP-36** • Reach Top Plus x Seconds - XXX SEC
- SP-37** • Fill Until Pan Empty - XXX SEC
- SP-38** • Valve Auto - Cycle Period - X:XX H:MM
- SP-39** • Refill Detect By.... - LVL PRBS or PRESSURE
- SP-40** • Min. Wash PSI - XX.XX PSI



5-2. SPECIAL PROGRAMMING
(CONTINUED)

- SP-41** • Max. Bubble PSI - XX.XX PSI
- SP-42** • Max. Wash Time - XXXX SEC
- SP-43** • Old Pad Max. Wash Time - XXXX SEC
- SP-44** • Min. Fill Time - XXX SEC
- SP-45** • New Pad Max. Fill Time - XXXX SEC
- SP-46** • Old Pad Max. Fill Time - XXXX SEC
- SP-47** • Required Bubble PSI Hits - XXX CNT
- SP-48** • Pressure Trip Limit - XXX PSI
- SP-49** • Pilot During Filter-PILOT OK or NO PILOT (**GAS FRYERS ONLY**)
- SP-50** • Filling - Low Heat On - XXX SEC
- SP-51** • Filling - Low Heat Off - XXX SEC
- SP-52** • Heat Error Enabled? - YES or NO
- SP-53** • Warm Return Line Enabled?/Interval - H:MM
(Hours/Minutes - OFF to 4 hours)
- SP-54** • Warm Return Line Time - M:SS
(Minutes/Seconds - 0:00 to 4 Minutes)
- SP-55** •
- SP-56** • Enable R & D Displays? - YES or NO

NOTICE

Not all Special Program Mode functions are discussed in this section. To ensure proper operation of fryer, please consult Henny Penny Corp. before changing any of these settings. For more information on these functions, contact the Service Department at 1-800-417- 8405, or 1-937-456-8405.

To Enter Special Programming:

1. Press and hold  and  buttons until LEVEL - 3 shows in the display, followed by ENTER CODE.
2. Enter code 1, 1, 2, 2, 1, 1, 2, 2 (first 2 product buttons).
3. “A. TECH” & “RESETS” show in displays. Press ▼ and “B. SPCL” & “PROG” show in the displays.

Zone - USA/Non-USA (SP-1)

4. Press √ button and “SP-1 ZONE” shows in the left display. Use ◀ and ▶ buttons to set the default set-points to USA specifications or non-USA specifications.

Initialize System (SP-2)

5. Press ▼ button and “SP-1 DO SYSTEM INIT” scrolls in left display. To reset the controls to factory default settings, press and hold √ button and controls count down “IN 3”, “IN 2”, “IN 1”. Once display shows “-INIT-” & *DONE* the controls are reset to factory defaults.

5-2. SPECIAL PROGRAMMING
(CONTINUED)

2nd Language (SP-3)

6. Press ▼ button and “SP-3 2ND LANGUAGE” scrolls in left display. Use ◀ and ▶ buttons to set to: ENGLISH; FRANCAIS; CAN FREN; ESPANOL; PORTUG; DEUTSHE; SVENSKA; РУССКИЙ or -NONE-.

By setting a second language in the controls, 2 languages can now be easily chosen by pressing  button twice during normal operation.

One language shows in left display and a second language shows in the right display. Pressing the √ button selects the language in the displays.

2nd Volume (SP-4)

7. Press ▼ button and “SP-5 2nd VOLUME” shows in display. If NONE is displayed, this option is off. Push ◀ and ▶ to turn option on and to set volume from 1-10.

Quick Configuration (SP-5)

8. Press ▼ button and “SP-5 QUICK CONFIG” shows in display. Use the ◀ and ▶ buttons to change the menu selection in the controls to: CHKN+FISH; FF/HBR; CHKN or EMPTY.

Polish Duration (SP-6)

9. Press ▼ button and “SP-6 POLISH” shows in left display. Use product buttons  to change polish time, from 5 minutes to a maximum of 10 minutes.

Drain Valve (SP-7)

10. Press ▼ button and “SP-7 DRAIN VALVE” scrolls in the left display. Use the ◀ and ▶ buttons to change the right display to show “NORMAL” or “MANUAL”.

NORMAL means drain valves are controlled electronically and MANUAL means drain valves must be opened by hand.

Edit Unit Serial Number (SP-8)

11. Press ▼ button and “SP-8 S/N ✓ EDIT” shows in the left display. Press the right ✓ button to enter the unit’s serial number in the controls, using the product buttons.



“STD” and “CUST” show in the right displays. Press the ✓ button under “STD” and the first 2 letters of the serial number is the standard equipment code, press X button and a custom equipment code can be entered. THIS SERIAL NUMBER SHOULD MATCH THE SERIAL NUMBER ON THE DATA PLATE, ON THE DOOR.

Dispose Requires Code (SP-55)

12. Press ▼ button and “SP-55 DISPOSE REQUIRES CODE” shows in the display. Using ◀ and ▶ to select YES/NO and confirm by pressing ✓ or cancel by pressing X.

5-2. SPECIAL PROGRAMMING
(CONTINUED)

Decal Layout (SP-9)

11. Press ▼ button and “SP-9 DECAL LAYOUT?” scrolls in the left display. The words in the right displays should match the arrow type above the  and  buttons.

EX: If the control decal shows   the right displays should show DOWN-UP  

If the displays show UP-DOWN, use the ◀ and ▶ buttons to change the displays to DOWN-UP.

Liquid or Solid Cooking Oil Used (SP-11)

12. Press ▼ button and “SP-11 MELT CYCLE SELECT” scrolls in the left display. Unless solid oil is being used in the vats the right display should show “1.LIQUID”.

If solid oil is used, the unit MUST BE equipped to handle solid oil. Use the ◀ and ▶ buttons to change the right display to “2.SOLID”

Change Pad Reminder Time (SP-12)

13. Press ▼ button and “SP-12 ‘CHANGE PAD’ REMINDER” shows on the display. Use the product buttons

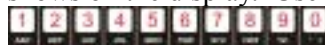

to change the time between changing the filter pad reminders.

For example, if “25 HRS” is programmed in the right display, every 25 hours the display shows “CHANGE PAD” as a reminder to the operator that the filter pad needs changed.

Pan Out of Fryer = Pad Changed (SP-13)

14. Press ▼ button and “SP-13 PAN OUT = CHANGED PAD” scrolls in the left display. Use the product buttons

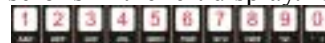

to program amount of time the drain pan is pulled-out from under fryer before the controls reset the change pad reminder. This is the amount of time it should take to change filter pad. The range is 15 to 255 seconds.





For example, if “120 SEC” is programmed in the right display, when the drain pan is out from under the fryer for at least 120 seconds, the controls restarts counting for the change pad reminder.

Auto-Fill Enabled (SP-14)(automatically keeps oil at proper level)

15. Press ▼ button and “SP-14 AUTO-FILL ENABLED?” scrolls in the left display. Use the ◀ and ▶ buttons to set the right display to “YES” or “NO”.

This should always be set to “YES”, unless a hardware failure causes a problem, such as a JIB pump or Add Oil valve failure.

5-3. CLOCK SET

1. Press and hold  and  buttons until LEVEL - 3 shows in the display, followed by ENTER CODE.
2. Enter code 1, 1, 2, 2, 1, 1, 2, 2 (first 2 product buttons).
3. “A. TECH” & “RESETS” show in displays. Press ▼ button twice and “C. CLOCK” and “SET” show in the displays.
4. Press √ button and “CS-1 ENTER DATE MM-DD-YY” shows in the left display. Use the product buttons  to set the date in right display.
5. Press ▼ button and “CS-2 ENTER TIME” shows in left display and time flashes in right display. Use product buttons  to change the time.
6. Press ▼ button and “CS-2 ENTER TIME” shows in left display and “AM” or “PM” flashes in right display. Use the ◀ ▶ buttons to change from AM to PM or vice-versa.
7. Press ▼ button and “CS-3 TIME FORMAT” shows in left display and “12-HR” or “24-HR” shows in right display. Use the ◀ ▶ buttons to change from a 12 hour time format to a 24 hour time format or vice-versa.
8. Press ▼ button and “CS-4 DAYLIGHT SAVING TIME” shows in the left display. Use the ◀ ▶ to change daylight saving time for your area: 1.OFF; 2.US (2007 & after); 3.EURO; or 4.FSA (US before 2007)

5-4. DATA COMM & HEAT CONTROL

NOTICE

Data communications and heat controls settings are shown in Level 3 Program Mode. But, to ensure proper operation of fryer, please consult Henny Penny Corp. before changing any of these settings. For more information on these functions, contact the Service Department at 1-800-417-8405, or 1-937-456-8405.

5-5. TECH MODE



The TECH Mode has self-diagnostic information, which can be used by certified technicians for troubleshooting purposes, such as:

- T-1** • Software
- T-2** • Fryer Type (Gas or Elec.)
- T-3** • Push Button Test
- T-4** • All On Display Test
- T-5** • Display Segments Test
- T-6** • Display Digits Test
- T-7** • Display Decimal Points Test
- T-8** • LED's Test
- T-9** • Left Temp. Probe Calibration & Offset
- T-10** • Left Level 1 Probe Calibration & Offset
- T-11** • Left Level 2 Probe Calibration & Offset
- T-12** • Right Temp. Probe Calibration & Offset
- T-13** • Right Level 1 Probe Calibration & Offset
- T-14** • Right Level 2 Probe Calibration & Offset
- T-15** • CPU Control Temp. Calibration/Offset/Highest
- T-16** • View A - D Channel
- T-17** • Digital Inputs
- T-18** • AIF Info
- T-19** • Outputs Test
- T-20** • Pumps & Valves Test
- T-21** • Change Tech Code?
- T-22** • Total Initialization

NOTICE

Not all Tech Mode functions are discussed in this section. To ensure proper operation of fryer, please consult Henny Penny Corp. before changing any of these settings. For more information on these functions, contact the Service Department at 1-800-417- 8405, or 1-937-456-8405.



5-5. TECH MODE
(CONTINUED)

1. To enter the TECH Mode, press and hold  and  buttons for 5 seconds, until display shows "LEVEL 3", followed by "ENTER CODE".
2. Enter code 1, 1, 2, 2, 1, 1, 2, 2 (first 2 product buttons). "A. TECH" & "RESETS" show in the displays.
3. Press ▼ 5 times, and when display shows "F. TECH", press the right √ button and T-1 "SOFTWARE" shows in the display, the first step of the TECH Mode. Use ▲ and ▼ buttons to toggle through the steps.

NOTICE

Press the right X button twice, at anytime to return to normal operation.

T-1 - SOFTWARE

- Press  to view HP Part No. of eprom
- Press  to view software ID
- Press  to view software version

T-2 - FRYER TYPE - GAS or ELEC

T-3 - PUSH-BUTTON TEST

Press any of the control buttons to test operation. You should hear a beep, and the LED should light and/or a display.

T-4 - ALL-ON DISPLAY TEST

Press any of the product buttons and all the LEDs and display segments should light.

T-5 - SEGMENTS TEST

Press any of the product buttons to view a different segment of the display characters.

T-6 - DIGITS TEST

Press any of the product buttons numerous times to view all segments of each digit across the displays.

T-7 - DECIMAL PTS TEST

Press any of the product buttons numerous times to view all decimal points across the displays.

5-5. TECH MODE
(CONTINUED)

T-8 - DECIMAL PTS TEST

Press any of the product buttons numerous times to view each LED across the control panel.

T-17 - DIGITAL INPUTS - HDF

H = HIGH LIMIT - If "H" is present, the high limit is good. If "-" shows then the high limit is tripped out (overheated) or disconnected.

D = DRAIN SWITCH - If "D" is present, the drain handle (when applicable) is closed. If "-" shows then the drain is open or the switch is faulty.

F = FAN (PRESSURE SWITCH) - If "F" is present, the pressure switch is good. If "-" shows in the display, the switch is faulty.

Press ► button and an underscore (" _ ") indicates the input is not presently detected. A Checkmark ("√") indicates the signal is detecting a normal input. A blinking ("X") indicates the signal is presently detected, but is detected as a half-wave (partially failed) input.

NOTICE

The H, D, F signals above are wired in series. The first signal missing out of this sequence I generally causes all signals to the right of it to be missing as well.

T-18 - AIF INFO (AIF PCB communicating with control PCB?)

An "AIF √" means normal communications between the AIF PCB and the control PCB. "AIF X" means a problem with the communications between the PCBs.

Press ▼ button and "FILR IN" and "USE BY 1(ex)" shows in the displays. These displays shows which controls are using the filtering system.

"USE BY 0" = not in use

"USE BY 7" = used by AIF

"USE BY 1 to 5" = used by control PCB

Press ▼ button and "CPU POSN" and "1 OF 3(ex)" shows in the displays. These displays shows which controls are plugged into which port on the AIF board.

For example, the left control should be plugged into port 1, and on a 3 control fryer, shows "1 OF 3" on the display.

If the right control is unplugged, then the left control would show "1 OF 2" instead of "1 OF 3".

5-5. TECH MODE
(CONTINUED)

Press ▼ button and “INP E_P_” and “JL_R_DF_” shows in the displays.

AIF Board Inputs:

E = Stop button	E* = E-Stop pressed.
P = Drain Pan	M* = drain pan is missing.
JL = JIB	J* = JIB oil level is low.
R = RTI	R* = RTI System Detected
DF = RTI Discard Tank	DF* = tank full

Press ▼ button and “OUT F_J_” and “N_DI_JFo” shows in the displays.

AIF Board Outputs:

Current outputs status from AIF board.

F = Filter Pump.	(F* = Filter pump is on)
J = JIB Pump.	(J* = JIB pump is on)
N = New Oil Pump.	(N* = RTI new oil pump on)
DI = Discard Valve.	(DIo = RTI disc. valve open/DIc=closed)
JF = JIB Fill Valve.	(JFo = RTI JIB fill valve open/ JFc=closed)

Press ▼ button and “REQ F_J_” and “N_DI_JFo_” shows in the displays.



AIF Board Outputs Requested by the Control Board:



Current outputs status from AIF board.



F = Filter Pump.	(F* = Filter pump is on)
J = JIB Pump.	(J* = JIB pump is on)
N = New Oil Pump.	(N* = RTI new oil pump on)
DI = Discard Valve.	(DIo = RTI disc. valve open/ DIc=closed))
JF = JIB Fill Valve.	(JFo = RTI JIB fill valve open/ JFc=closed)

T-19 - OUTPUTS

F = FAN (PRESSURE SWITCH)- Press  or  to open and close the pressure switches

S = SAFETY GAS VALVE (if available) - Press  or  to open and close the gas safety valves

I = IGNITION MODULE - Press  or  to open and close the outputs on the ignition modules

H = HEAT OUTPUTS - Press  or  to turn on and off the heating outputs (ex: gas valve)

5-5. TECH MODE
(CONTINUED)

T-20 - PUMPS & VALVES

Press $\sqrt{}$ button and “VALVES” “DcRcAc” shows in displays.

Press  to open and close the drain valves.

Press  to open and close the return valves.

Press  to open and close the add valves.

“DcRcAc” means valves are closed, “DoRoAo” means valves are open. (Driven by the control board)

Press \blacktriangledown button and “DISCARDc” and “JIBFILLc” shows in the displays. (Driven by the AIF board)

Press  to open and close the RTI discard valve (display shows “DISCARDo” when open)

Press  to open and close the RTI JIB fill valve (display shows “JIBFILLo” when open)

Press \blacktriangledown button and “PUMP FP_” and “JP_ NP_” shows in the displays. (Driven by the AIF board)

Press  to turn off and on the filter pump (display shows “FP*” when on)

Press  to turn off and on the JIB pump (display shows “JP*” when on)

Press  to turn off and on the RTI new oil pump (display shows “NP*” when on)



Press \blacktriangledown button and “LIGHTS” and “FLT_ JLO_” shows in the displays. (Driven by the AIF board)

Press  to turn off and on the FILTER light (display shows “FLT*” when on)

Press  to turn off and on the JIB LOW light (display shows “JLO*” when on)

5-6. STATS MODE

This mode allows a technician to view advanced information on the operation of the fryer and controls.

1. To enter the TECH Mode, press and hold  and  buttons for 5 seconds, until display shows "LEVEL 3", followed by "ENTER CODE".
2. Enter code 1, 1, 2, 2, 1, 1, 2, 2 (first 2 product buttons). "A. TECH" & "RESETS" show in the displays.
3. Press ▼ 6 times, and when display shows "G. STATS", press the right √ button and "ST-1 LAST RESET ON..." shows in display, the first step of the TECH Mode. Use ▼ and ▲ buttons to toggle through the steps.

- ST-1** • Stats Last Reset Date
- ST-2** • Fryer Total Running Hours
- ST-3** • Left Vat Melt Cycle Hours
- ST-4** • Left Vat Cook Cycle Hours
- ST-5** • Left Vat Filter Lockout Hours
- ST-6** • Right Vat Melt Cycle Hours
- ST-7** • Right Vat Cook Cycle Hours
- ST-8** • Right Vat Filter Lockout Hours
- ST-9** • Power-Ups Count
- ST-10** • Error Counts
- ST-11** • Left Vat Heat On Hours
- ST-12** • Right Vat Heat On Hours
- ST-13** • Highest Left Vat Oil Temperature
- ST-14** • Highest Right Vat Oil Temperature
- ST-15** • Highest CPU Temperature
- ST-16** • System RAM Fade Count
- ST-17** • Cook RAM Fade Count
- ST-18** • Product RAM Fade Count
- ST-19** • Stat RAM Fade Count
- ST-20** • RAM Data Error Count
- ST-21** • Data Total Loss Count
- ST-22** • User Initialization Count
- ST-23** • Automatic Initialization Count
- ST-24** • Cooks Count per Product
- ST-25** • Cook Cycle Stop Counts
 - "A" = number of stops in the first 30 seconds
 - "B" = 0
 - "C" = 0
 - "D" = complete cook cycles counted
- ST-26** • Reset All Stats

SECTION 6. INFORMATION MODE

6-1. INFO MODE

This mode gathers and stores historic information on the fryer and operator’s performance. Press and hold  for 3 seconds, until *INFO* *MODE*” shows on the displays.

Press ▼ or ▲ buttons to access the steps and press √ button to view the statistics within each step.

This mode includes the following information:

1. **FILTER STATS** - filtering information for the last 7 days
2. **REVIEW USAGE**- information accumulated since the last time this data was manually reset
3. **LAST LOAD** - information about the most recent Cook Cycle, or the cycle presently in progress

NOTICE

Press X button to exit from the Information Mode.

1. FILTER STATS

Press √ button to select Filter Stats and then press ◀ and ▶ to select the day for which you want to view the stats. Then press ▼ or ▲ buttons to view the following stats:

- “FILTERED” = No. of times filtered
- “FLT BPSD” = No. of times filtering was skipped
- “FLT AVG” = Average no. of cook cycles between filters

2. REVIEW USAGE

Press √ button to select Review Usage and press ▼ or ▲ buttons to view the following:

FUNCTION	DISPLAY EX:
Day usage data was previously reset	SINCE 9:32P 04-19-10
Total number of cook cycles	TOTAL COOKS 462
Cook Cycles stopped before “PULL”	QUIT COOK 4
Number of hours fryer was on (left)	L ON HRS 165
Number of hours fryer was on (right)	R ON HRS 160

6-1. INFO MODE
(CONTINUED)

3. LAST LOAD

Press √ button to select Last Load (ex: -P1- = Product 1; ”L1” = left, 1st product) and press ▼ or ▲ buttons to view the following:

FUNCTION	DISPLAY EX:
Product (Last product cooked)	PRODUCT -P1- L1
Time of day last Cook Cycle was started	STARTED 10.25A SEP-08
Actual Elapsed cook Time (Real seconds)	ACTUAL TIME 7:38
Programmed cook Time	PROG TIME 3:00
Max Temp during Cook Cycle	MAX TEMP 327°F
Min Temp during Cook Cycle	MIN TEMP 313°F
Avg Temp during Cook Cycle	AVG TEMP 322°F
Heat On (percentage) during Cook Cycle	HEAT ON 73%
Ready? (Was fryer Ready before start?)	READY? YES

SECTION 7. MAINTENANCE

7-1. PREVENTIVE MAINTENANCE

To ensure a long life of fryers and their components, regular maintenance should be performed. Refer to the chart below.

Frequency	Action
Daily	Maintenance Filter (See Maintenance Filtering Instructions Section in Operator's Manual or PM Guide)
Daily	Change Filter Pad (See Changing Filter Pad Section in Operator's Manual or PM Guide)
Weekly	Clean Behind Fryer (See PM Guide)
Quarterly	Change Filter Pan O-Rings (See PM Guide)
Quarterly	Vat Deep Clean (See Deep Clean Mode Section in Operator's Manual or PM Guide)
Semi-Annually	Clean Blower Motors (See PM Guide)

7-2. MAINTENANCE HINTS

1. You may need to use a multimeter to check the electric components.
2. When the manual refers to the circuit being closed, the multimeter should read zero unless otherwise noted.
3. When the manual refers to the circuit being open, the multimeter will read infinity.

7-3.COMPLETECONTROL REPLACEMENT

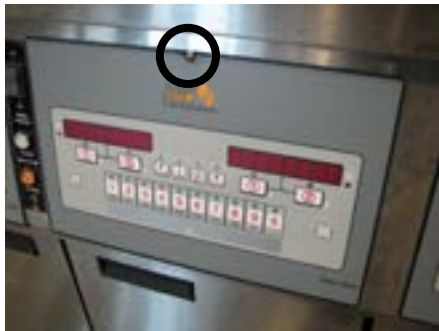

1. Remove electrical power supplied to the unit.



To avoid electrical shock or property damage, move the POWER switch to OFF and disconnect main circuit breaker, or unplug cord at wall receptacle.

2. Using a phillips head screw driver, loosen (do not remove) the screw located at the top of the control board.
3. Slide the control board down until the notch is clear of the screw.
4. Tilt the entire control board down allowing it to rest.
5. Disconnect all connectors from control board. Make note of the locations of the connectors for the reinstall.
6. Remove the old control board and replace with the new board.

CAUTION

When plugging connectors onto new control panel, be sure the connectors are inserted onto all of the pins, and that the connectors are not forced onto the pins backwards. If not connected properly, damage to the board could result.

7. Reconnect all connectors.
8. Tilt control board back to factory location and secure with the screw.
1. Lower the control board (see Control Board Replacement).
2. Press on the switch from the inside of the fryer to release from the metal shroud.
3. Mark and disconnect the wires from the switch.
4. Connect the wires onto the new switch on the correct terminals.
5. Press back into factory location.

7-4.POWERSWITCH REPLACEMENT



7-5. BURNER TUBE REMOVAL



7-6. PILOT REPLACEMENT



1. Remove electrical power supplied to the unit.



To avoid electrical shock or property damage, move the POWER switch to OFF and disconnect main circuit breaker, or unplug cord at wall receptacle.

2. Lower the control board (refer to the Control Board section).
3. Using a 5/16" socket, remove the 2 screws that secure the burner support bar to the burner assembly.
4. Remove the support bar.
5. Pull down on the burner tubes to release them from the orifices. Once the burner tube is cleared from the orifice, pull the tube out of the assembly.
6. To reassembly the burners, slide each burner tube onto the orifice.
7. Line the notches on the support bar to each tube.
8. Tighten the screws to the assembly.
1. Remove electrical power supplied to the unit.
2. Lower the control board (refer to the Control Board section).
3. Remove burner tubes (refer to the Burner Tube Removal section).
4. Remove the flame sensor wire.
5. Remove the two screws securing the pilot to the burner assembly. The right hand screw will have the ground wire.

**7-6.PILOTREPLACEMENT
(CONTINUED)**

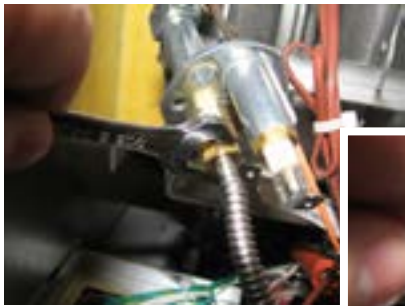

6. Disconnect the pilot wire located in the orange rubber sleeve.
7. Using a 7/16” wrench, loosen the pilot tube from the pilot.
8. Using a 7/16” wrench loosen and remove flame sensor.
9. Replace pilot in reverse order.
10. When screwing the pilot back to the burner assembly, be sure to connect the ground wire to the right hand screw.

NOTICE

To replace the flame sensor, leave pilot assembly attached to the burner assembly and remove only the flame sensor with a 7/16” wrench.

**7-7. HIGH LIMIT
THERMOCOUPLE**



1. Remove electrical power supplied to the unit.



To avoid electrical shock or property damage, move the **POWER** switch to **OFF** and disconnect main circuit breaker, or unplug cord at wall receptacle.

2. Lower the control board (refer to the Control Board section).
3. Remove burner tubes (refer to the Burner Tube Removal section).
4. Disconnect the wires from the high limit control located behind the control board mounted to the frame.
5. Using a 1/2” wrench, loosen the compression fitting on the probe.
6. Slide the fitting nut and the ferrule back to loosen the probe..

**7-7. HIGH LIMIT
THERMOCOUPLE
(CONTINUED)**



7. Remove the pot bushing from the vat. Replace with the new bushing included with new part. Apply thread sealant and tighten into vat.
8. Apply thread sealant to the compression fitting. Thread into the pot bushing.
9. Insert the probe into the compression nut and the ferrule.
10. Insert the new probe into the compression fitting. Be sure to insert the probe end into the sleeve welded to the burner tube inside of the vat.
11. Tighten the compression fitting nut.

**7-8. HIGH LIMIT
CONTROL**



1. Remove electrical power supplied to the unit.



To avoid electrical shock or property damage, move the POWER switch to OFF and disconnect main circuit breaker, or unplug cord at wall receptacle.

2. Lower the control board (refer to the Control Board section).
3. Mark and disconnect the wires located on the high limit control.
4. Using a 3/8" wrench, remove the nuts.
5. Remove the clamp bars.
6. Slide the high limit control off of mounting studs.
7. Install the new control in reverse order.

7-9. PROBE REPLACEMENT



1. Remove electrical power supplied to the unit.



To avoid electrical shock or property damage, move the POWER switch to OFF and disconnect main circuit breaker, or unplug cord at wall receptacle.

2. Lower the control board (refer to the Control Board section).
3. Remove burner tubes (refer to the Burner Tube Removal section).
4. Using a 1/2" wrench, loosen the compression nut.
5. Using pliers, remove the ferrule.
6. Pull the probe from the vat.
7. Trace the probe wire to the connected located on the back of the control board.
8. Disconnected the connector. Using a flat blade screw driver or pin pusher, press in on the clip and remove wire from connector.
9. Insert the new probes wire into the connector.
10. Replace probe in reverse order.
11. Use the gage to adjust the probe.

7-10. BACK SHROUD REMOVAL



1. Using a phillips head bit or screw driver, loosen the four screws on the lower shroud.
2. Remove shroud and set aside to access all back components.

7-11. BLOWER REPLACEMENT

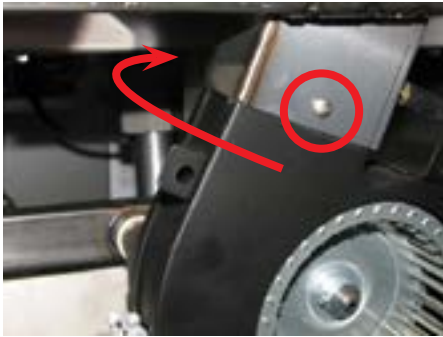

1. Remove electrical power supplied to the unit.



To avoid electrical shock or property damage, move the POWER switch to OFF and disconnect main circuit breaker, or unplug cord at wall receptacle.

2. Remove the lower back shroud (See back shroud removal).
3. Using a phillips head screw, remove the two screws that secures the blower to the flue. One screw is located on the back side of the flue.
4. Cut zip ties that are holding the wires to the blower. Remove the wire nuts from the wires.
5. Remove blower.
6. Reconnect new blower wires to the existing wires with wire nuts.
7. Tighten the new blower onto the flue with the two screws.
8. Zip tie wires back to the blower.

7-12. VACUUM SWITCH REPLACEMENT



1. Remove electrical power supplied to the unit.
2. Remove the lower back shroud (See back shroud removal).
3. Remove the vacuum hose from switch.
4. Using a phillips bit or screwdriver, remove the two screws securing switch to the frame.
5. Disconnect the wires on the switch.
6. Replace switch in reverse order.

**7-13. JIB PUMP
REPLACEMENT**



1. Remove electrical power supplied to the unit.



To avoid electrical shock or property damage, move the POWER switch to OFF and disconnect main circuit breaker, or unplug cord at wall receptacle.

2. Remove the lower back shroud (See back shroud removal).
3. Remove blower (see blower removal sections).
4. Using an adjustable wrench, remove the flex line from the elbow.
5. Loosen the hose clamp with a flat blade screw driver and disconnect the hose.
6. Use a 3/8 socket or wrench and remove the four nuts and washers from the pumps feet.
7. Pull the pump off of the studs.
8. Remove the wire nuts.
9. Wire the new pump into the existing wires.
10. Place the pump onto the studs. Be sure to have the shield box in place on the studs before placing the pump onto studs.
11. Tighten the pump nuts and washers onto the feet of the pump.
12. Reconnect fittings.
13. Replace blower.

7-14. SELECTOR VALVE DRIVE MOTOR REPLACEMENT

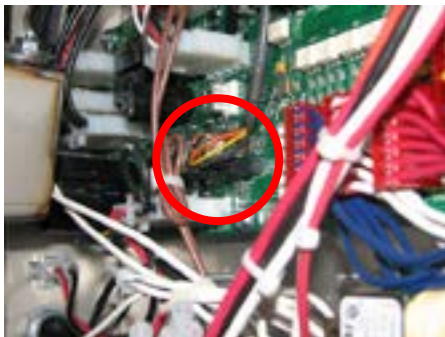

1. Remove electrical power supplied to the unit.



To avoid electrical shock or property damage, move the POWER switch to OFF and disconnect main circuit breaker, or unplug cord at wall receptacle.

2. Remove the lower back shroud (See back shroud removal).
3. Remove blower (see blower removal sections).
4. Disconnect the selector valve motor wires located in the back of the fryer.
5. Move to the front of the fryer. Remove the AIF housing cover.
6. Locate and disconnect the encoder wires from the AIF board. Move to the back of the fryer.

7. Remove the phillips head screw on the selector valve and remove the shield.
8. Using a 5/32 allen wrench (recommended T-Handle), remove the two diagonal bolts circled to the right.

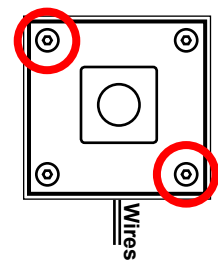

9. Remove the shield.
10. Remove the remaining two bolts.



**7-14. SELECTOR
VALVE DRIVE MOTOR
REPLACEMENT
(CONTINUED)**



11. Using a 5/32 allen wrench (recommended T-Handle), loosen the 4 screws on the coupler that is clamped onto the drive tube.
12. Lift motor off of selector valve body.
13. Move to the front of the fryer and locate Port 10 on the selector valve body. This will be the port located in the JIB area.
14. Using an adjustable wrench, remove the flex line from port 10.
15. Next remove the fitting and set aside. This will allow the inside valve to be visible.



16. Rotate the valve by hand until the hole is lined up with the threaded hole on the valve body.

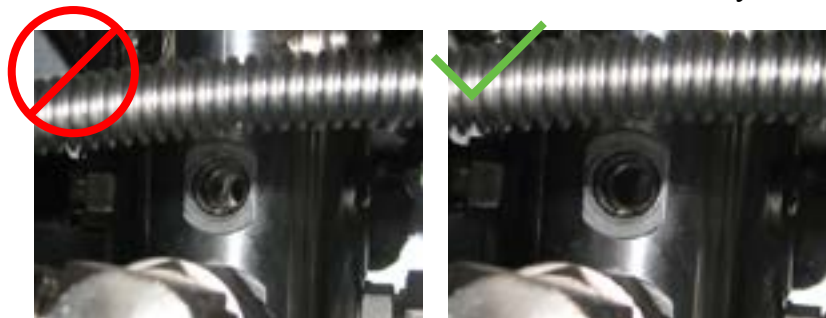

17. Place the new motor onto the selector valve mounting plate.
18. Plug the encoder wire back into the AIF board where it was previously removed. Place AIF board box cover back into position.
19. Reconnect the new motor wires

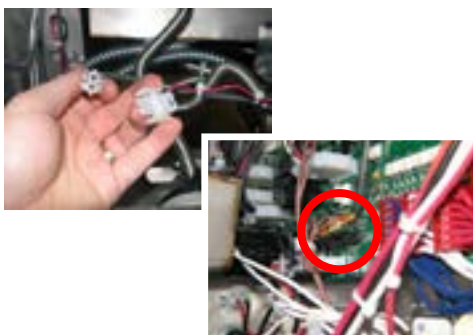

**7-14. SELECTOR
VALVE DRIVE MOTOR
REPLACEMENT
(CONTINUED)**

20. Tighten the bolts with the 5/32 allen wrench.

CAUTION

- DO NOT tighten the coupler at this time
- DO NOT install the shield at this time

21. Reconnect the power cord to the unit. The selector valve will run a quick calibration to find the home position.

22. Once calibration is complete, tighten the coupler to the motors drive tube.



NOTICE

When tightening the coupler, use the torque specs are as follows:
Top 2= 50 in-lbs
Bottom 2= 10 in-lbs



23. With the coupler tightened to the correct specs, run a calibration to confirm all ports are properly aligned.

Calibrate Selector Valve

1. Press and release both  buttons.
2. Press ◀ or ▶ until you reach 13. "PUMPS & VALVES".
3. Press the INFO button 3 times "SELECTOR VALVE AT HOME".
4. Press the  then ✓ to confirm.
5. Once calibration has completed check Port 10 to confirm the inner hole is lined with valve body hole.
6. Continue with the reassembly.

Reinstall Continued

24. Install fitting back to selector valve and tighten. Then tighten the flex line.

25. Install the shield and plate to the selector valve assembly.

**7-15. GAS VALVE
REPLACEMENT**

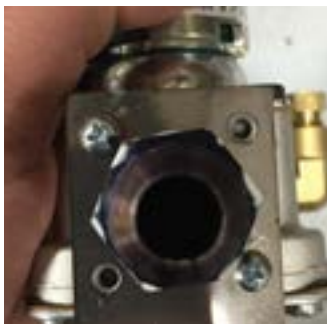

1. Remove electrical power supplied to the unit.



To avoid electrical shock or property damage, move the POWER switch to OFF and disconnect main circuit breaker, or unplug cord at wall receptacle.

2. Use a phillips head bit or screwdriver to lower the control board.
3. Use a 3/8 in. wrench to remove the two (2) flex tubes from the burner pilot to the gas valve.
4. Use an adjustable to remove the flex line from the back of the gas valve that is leading to the gas manifold.
5. Mark the locations of the wires on the gas valve and then remove the wires.
6. Use a 3/8 in. wrench or socket to remove the three (3) nuts located on the bottom-side of the shroud (behind the door).
7. Lift the gas valve from the bottom of the shroud. Use an adjustable to remove the flex line from the front of the gas valve leading to the burner.
8. Remove the brass fitting or fittings from either side of the gas valve and save for reuse.
9. Remove the fittings from the front and back of the gas valve.
10. Use a phillips head screwdriver to remove the four (4) screws that secure the mounting bracket onto the valve.
11. Install the new gas valve in reverse order.

SECTION 8. PARTS INFORMATION

8-1. INTRODUCTION

This section lists the replaceable parts of the Henny Penny Model LVG fryer.

8-2. GENUINE PARTS

Use only genuine Henny Penny parts in your fryer. Using a part of lesser quality or substitute design may result in damage to the unit or personal injury.

8-3. WHEN ORDERING PARTS

Once the parts that you want to order have been found in the parts list, write down the following information:

Item Number 2
Part Number 60241 Example:
Description High Limit

From the data plate, list the following information:

Product Number 01100
Serial Number 0001 Example:
Voltage 208

8-4. PRICES

Your distributor has a price parts list and will be glad to inform you of the cost of your parts order.

8-5. DELIVERY

Commonly replaced items are stocked by your distributor and will be sent out when your order is received. Other parts will be ordered, by your distributor, from Henny Penny Corp. Normally, these will be sent to your distributor within three working days.

8-6. WARRANTY

All replacement parts (except lamps and fuses) are warranted for 90 days against manufacturing defects and workmanship. If damage occurs during shipping, notify the carrier at once so that a claim may be properly filed. Refer to warranty in the front of this manual for other rights and limitations.

8-7. RECOMMENDED SPARE PARTS FOR DISTRIBUTORS

Recommended replacement parts are indicated with A or B in the parts lists:

A = parts to be stocked on service vans or trucks

B = parts to be stocked at the distributor/KES location.

Inventory on all other parts not identified, should be based upon usage in the territory. Please use care when ordering recommended parts, because all voltages and variations are marked. Distributors should order parts based upon common voltages and equipment sold in their territory.

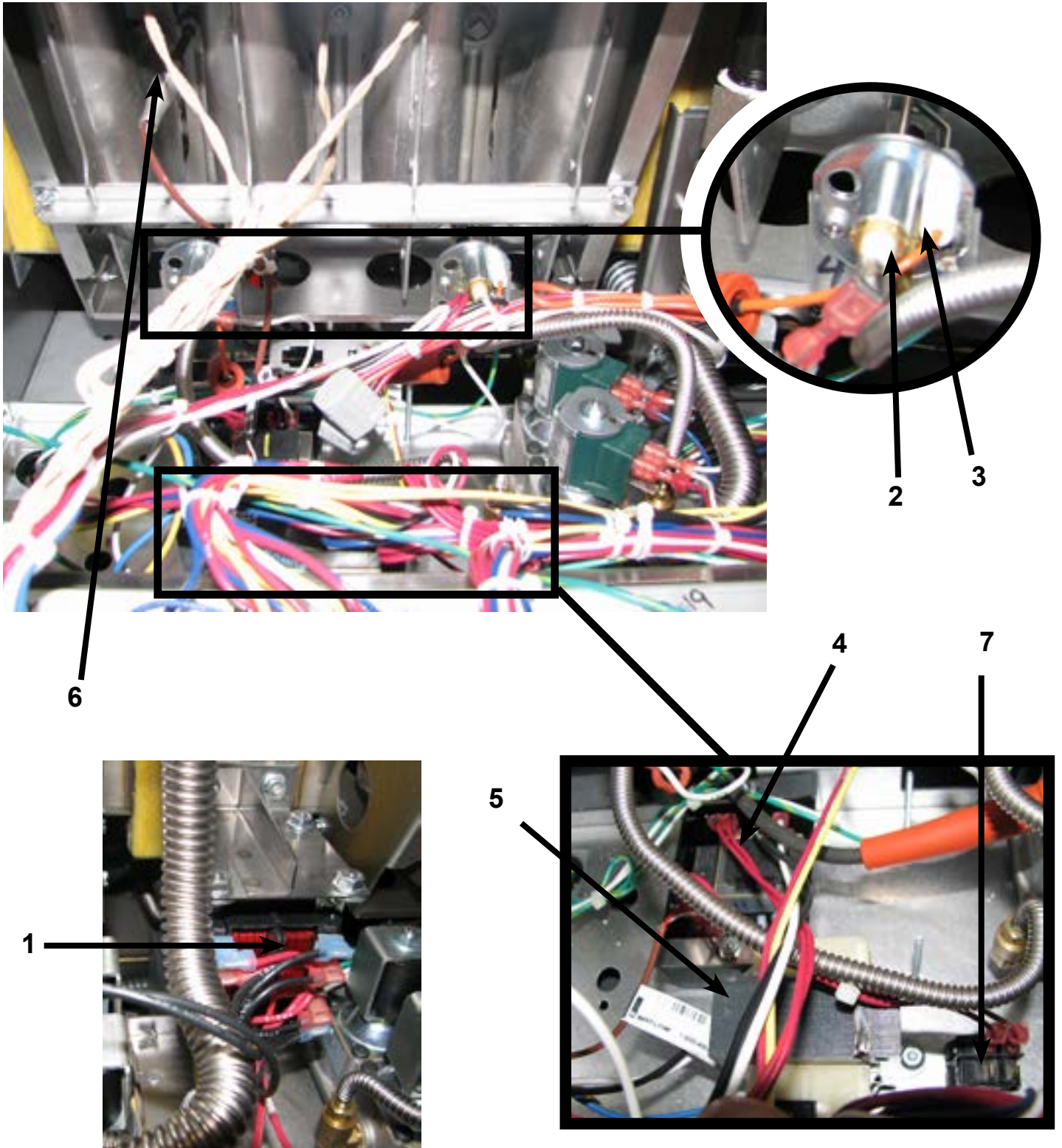

Item No.	Part No.	Description	Quantity
B 1	TS22-012	TRANSFORMER - AIF	1
A 2	76978	FLAME SENSOR.....	2/vat
A 3	75854	ASSY - SPARK IGNITOR (PILOT)	2/vat
A 4	89624-001	HIGH LIMIT CONTROL - 120V.....	1/vat
A 4	89624-002	HIGH LIMIT CONTROL - 230V.....	1/vat
A 5	84391	ASSY-75VA TRANSFORMER (120V-Pri/24v-Sec)	1/vat
A 5	84135	ASSY-75VA TRANSFORMER (240V-Pri/24v-Sec)	1/vat
A 6	92717	THERMOCOUPLE - HIGH LIMIT.....	1/vat
A 7	84987	SWITCH - MOMENTARY SPLASH PROOF.....	1/vat
A 8*	76979	ORIFICES (See chart below).....	4/vat
9*	140210	KIT- NAT TO LP S UP TO 5000 FT.....	1/vat
10*	140211	KIT- NAT TO LP F UP TO 5000 FT.....	1/vat
11*	140214	KIT- LP TO NAT S UP TO 5000 FT.....	1/vat
12*	140215	KIT- LP TO NAT F UP TO 5000 FT.....	1/vat
13*	140216	KIT- NAT TO LP S 5000-10000 FT	1/vat
14*	140217	KIT- NAT TO LP F 5000-10000 FT	1/vat
15*	140218	KIT- LP TO NAT S 5000-10000 FT	1/vat
16*	140219	KIT- LP TO NAT F 5000-10000 FT	1/vat
17*	140220	KIT- NAT TO NAT SEAT LVL TO HA.....	1/vat
18*	140221	KIT- LP TO LP SEA LVE TO HA.....	1/vat
19*	140222	KIT- NAT TO NAT HA TO SEA LVL.....	1/vat
20*	140223	KIT- LP TO LP HA TO SEA LVL	1/vat
21*	88226	PACK-SVCE OFG32X CE PILOT TUBE	A/R

B	PART NO.	BURNER ORIFICE DRILL SIZE (DIA.)	GAS TYPE	ALTITUDE
B	76979-001	#45 (0.082)	NATURAL	5301
	76921-001	#45 (0.082)	12H, 12E	--
	76979-002	1.30mm (0.0512)	PROPANE	ALL
	76921-002	1.30mm (0.0512)	13P	ALL
	76921-003	#44 (0.086)	NATURAL	5302 - 7701
	76921-004	#43 (0.089)	NATURAL	7702 - 10101
	76921-005	#42 (0.0935)	12S	--
	76921-006	#51 (0.067)	12E+	--
	76921-007	2.30mm (0.0906)	12L	--
	76921-008	1.25mm (0.0492)	13B/P	--
	76921-010	1.90mm (0.0768)	13A	--
	76921-011	1.04mm (0.0409)	13B/P	--
	76921-012	1.18mm (0.0465)	13B/P	--
	76921-013	#54 (0.055)	PROPANE	--

Recommend Parts: A=Truck Stock/B=Dist. Stock / *not shown

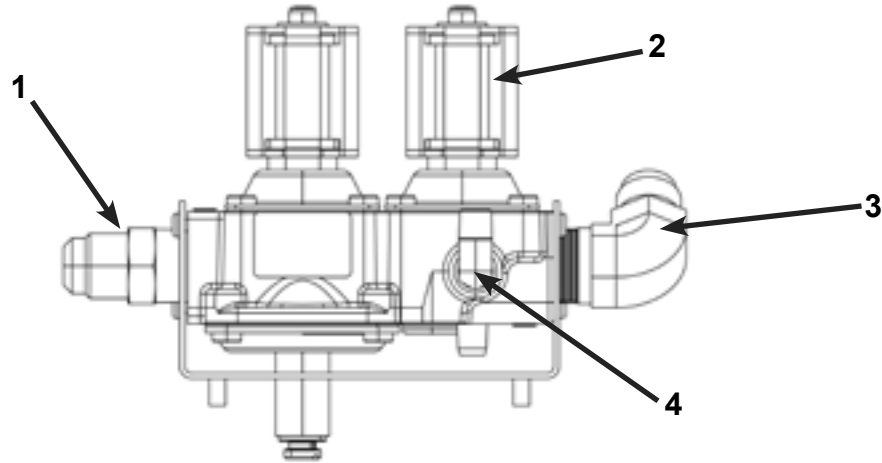

NON-CE GAS VALVE ASSEMBLY

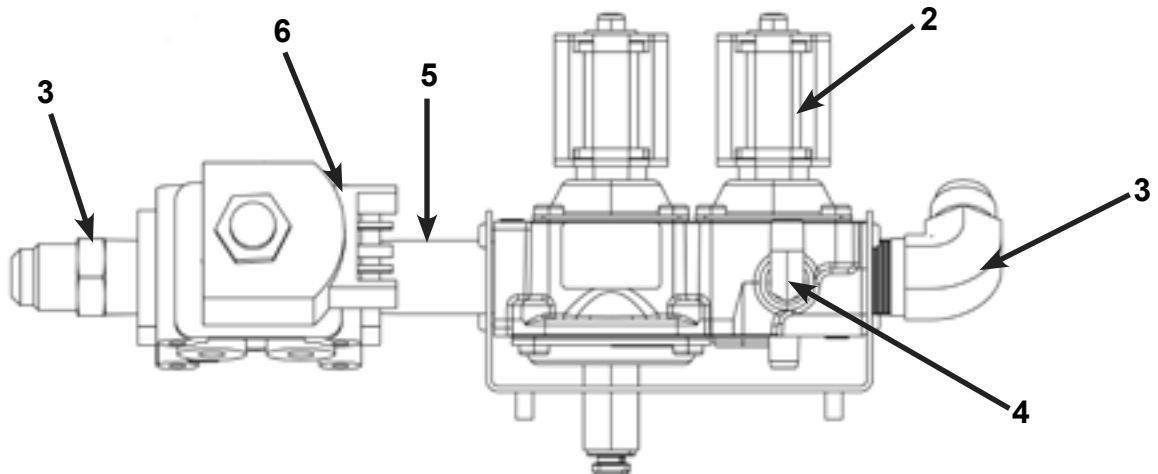

CE GAS VALVE ASSEMBLY

Item No.	Part No.	Description	Quantity (per assy)
1	FP01-242	FITTING - 1/2 NPT M to 45 FLARE M	1
A 2	87648-001	VALVE - GAS CONTROL - NAT - FULL.....	1/vat
A 2	87648-002	VALVE - GAS CONTROL - NAT - SPLIT.....	1/vat
A 2	87648-003	VALVE - GAS CONTROL - LP - FULL.....	1/vat
A 2	87648-004	VALVE - GAS CONTROL - LP - SPLIT.....	1/vat
3	FP01-205	ELBOW - 1/2 IN NPT MALE 45 FLARE	1
4	FP05-004	ELBOW - 1/4 TUBE TO 1/8 PIPE Z.....	2-full/1-split
5	FP02-012	NIPPLE - 1/2 X 2 - 304 SS.....	1
A 6	34802	VALVE - SOLENOID GAS - 24V - 50/60 HZ.....	2

Recommend Parts: A=Truck Stock/B=Dist. Stock / *not shown

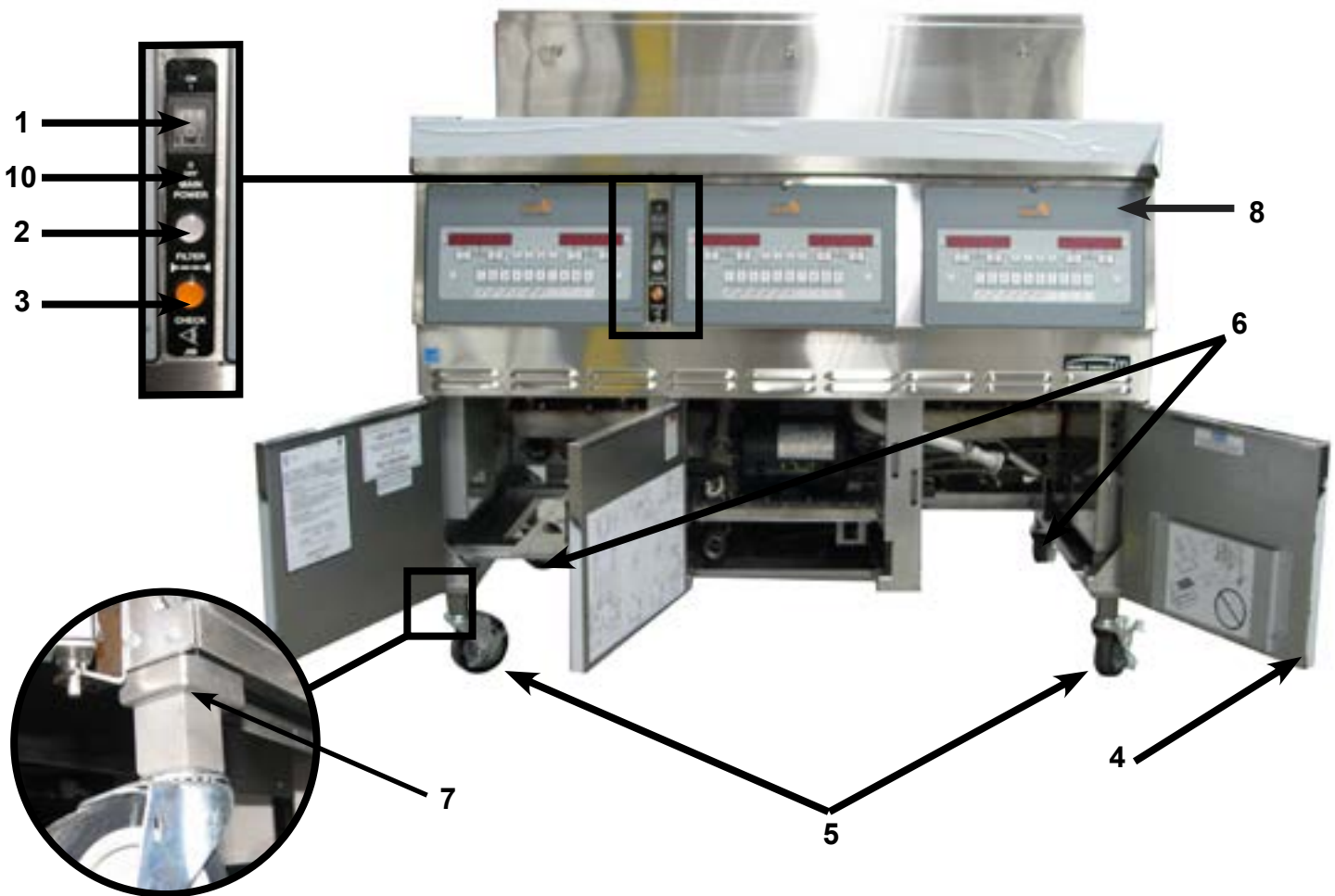

Item No.	Part No.	Description	Quantity
A 1	52224	SWITCH - POWER.....	1
B 2	75860	LIGHT - INDICATOR - BLUE.....	1
B 3	75859	LIGHT - INDICATOR - YELLOW.....	1
4	-----	ASSY-DOOR.....	See chart on next page
5	77575	CASTER- 4" W/BRAKE.....	2
6	77679	CASTER- 4" W/O BRAKE.....	2
7	83937	SUPPORT-CASTER MTG 202.....	4
B 7	83933	SUPPORT- CASTER MTG 203-204.....	4
8	-----	ASSY- CONTROL BOARD.....	see page 8-7
9*	03647	COVER - SPLIT VAT.....	1/vat
10	77103	DECAL-FLTR/CK JIB/MAIN POWER.....	1
11*	03646	COVER - FULL VAT.....	1/vat
12*	77842	HANGER-BASKET - LVG-102.....	1
12*	77709	HANGER-BASKET - LVG-103.....	1
12*	77934	HANGER-BASKET - LVG-104.....	1
A 13*	60818	RELAY - 24VAC COIL (Full Vat Fryers Only).....	1/vat
14*	140071	TETHER KIT-GAS FRYER.....	1

Recommend Parts: A=Truck Stock/B=Dist. Stock / *not shown

83774 LH Door Assy without Holder	86382 RH Door Assy with Holder
--	---

Model LVG-202

83774 LH Door Assy without Holder	83774 LH Door Assy without Holder	86382 RH Door Assy with Holder
--	--	---

Model LVG-203

87432 LH Door Assy without Holder	83774 LH Door Assy without Holder	83774 RH Door Assy- without Holder	86382 RH Door Assy with Holder
--	--	---	---

Model LVG-204

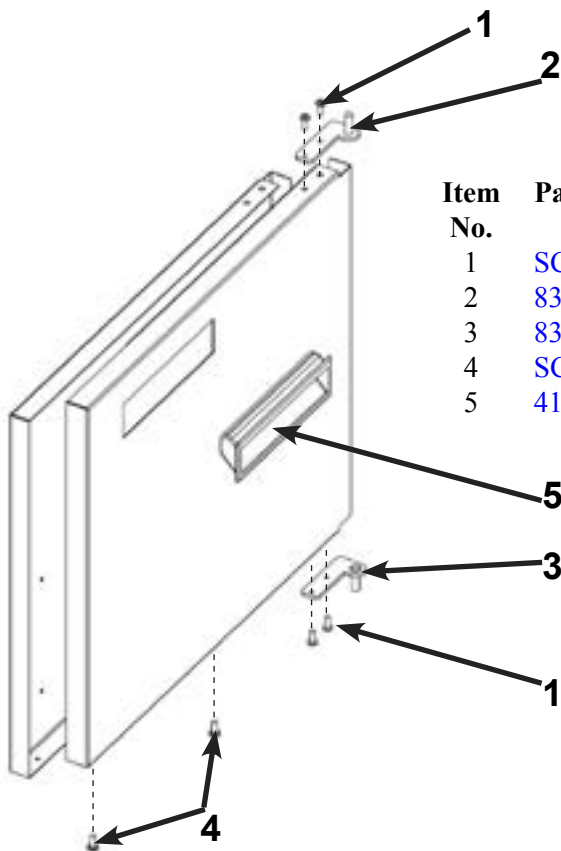

Item No.	Part No.	Description	Quantity
1	SC04-001	SCREW - #6-32 X 3/8 PH TYPE F C	4
2	83904	STUD ASSY - DOOR HINGE-RH	1
3	83903	STUD ASSY - DOOR HINGE-LH	1
4	SC04-003	SCREW - #8-32 X 3/8 PH HPD S.....	2
5	41836	HANDLE - DOOR	1

Recommend Parts: A=Truck Stock/B=Dist. Stock / *not shown

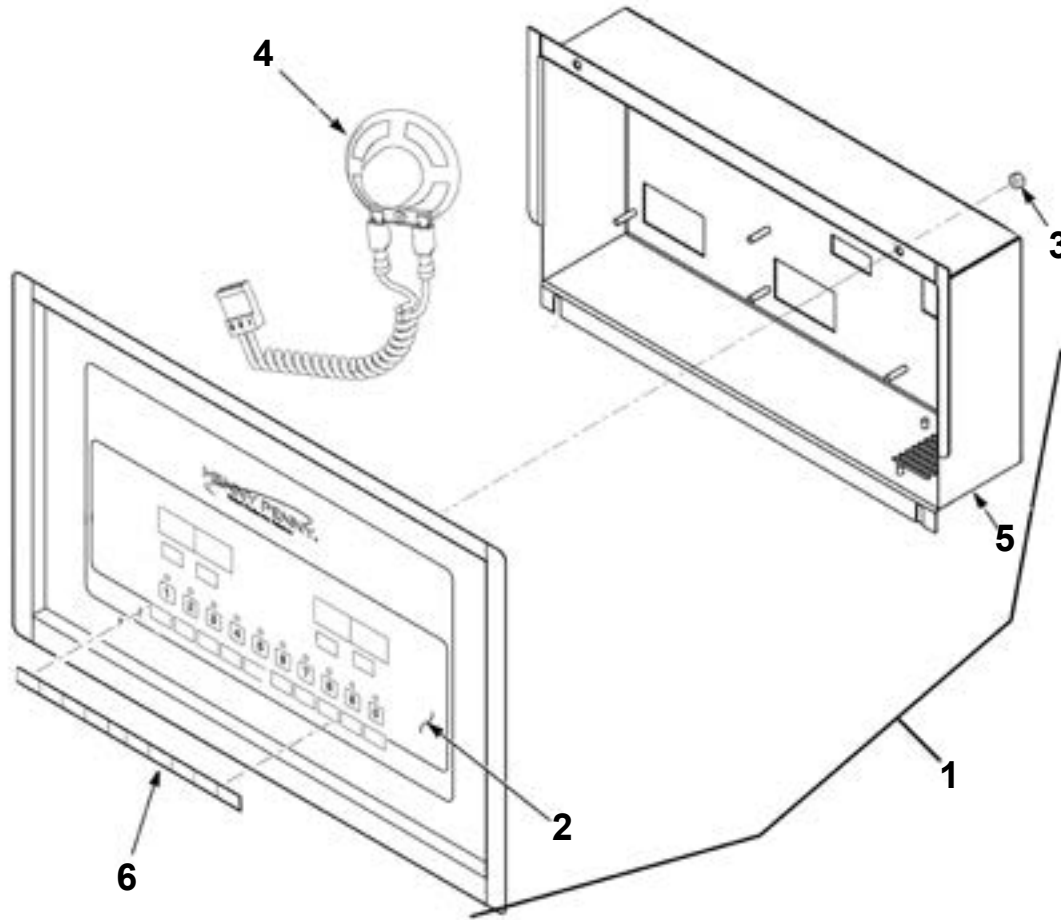

Item No.	Part No.	Description	Quantity
B 1	97319	ASSY - CONTROL - LOV	3
2	85378	DECAL - LOV MCD	1/control
3	NS02-005	NUT - HEX KEPS #6-32 C	23/control
B 4	26974	ASSY - SPEAKER	1/control
5	83498	STUD ASSY - CONTROL PANEL COVER	1/control
6	77249	MENU CARD - BLANK - LOV	1/control
6	77250	MENU CARD - FVA - LOV	1/control
6	77251	MENU CARD - SPA - LOV	1/control
A 7*	MS01-571	TOOL - TERMINAL EXTRACTOR (not shown)	1
8	14130	KIT- LVE/LVG-MMC COMM.....	1

Recommend Parts: A=Truck Stock/B=Dist. Stock / *not shown

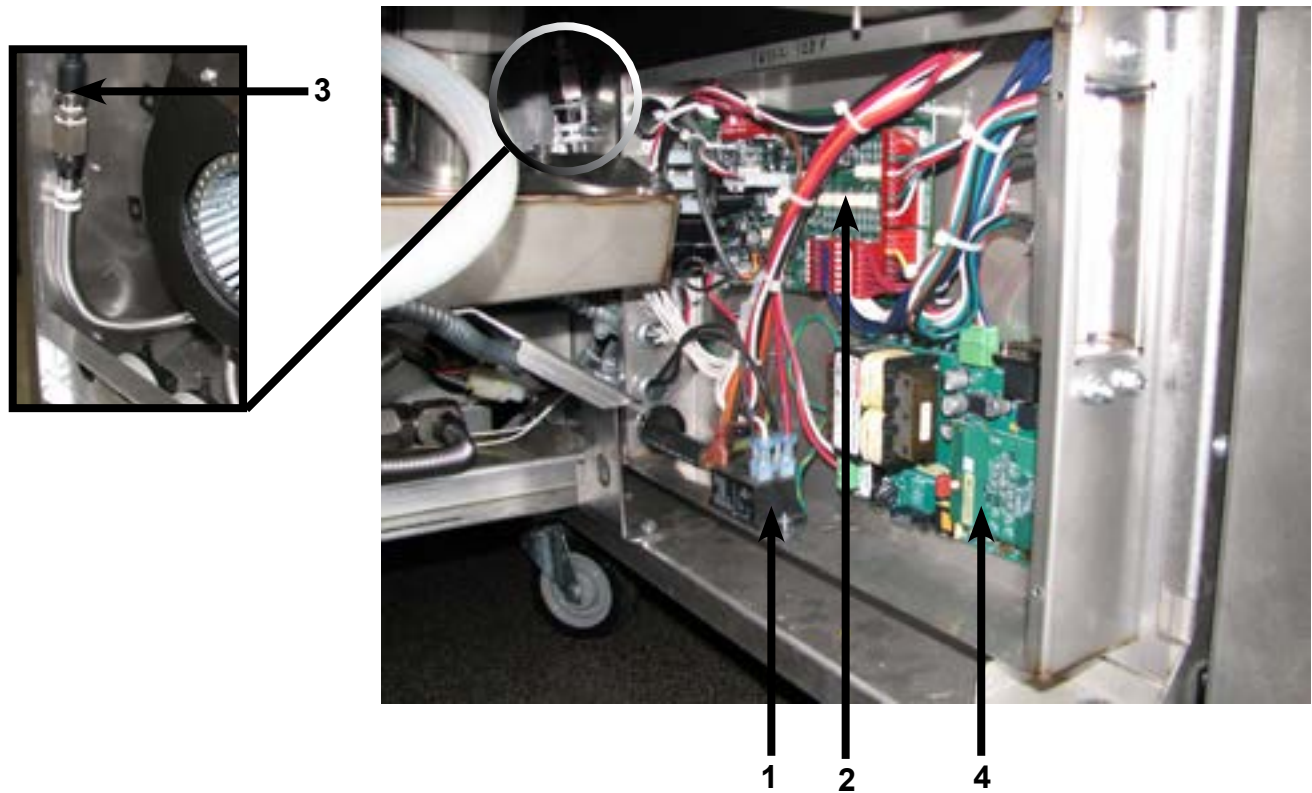

Item No.	Part No.	Description	Quantity
B 1	ME90-008	RELAY - PUMP MOTOR - 12 VDC - 30 AMP	1
B 2	85698RB	PC BOARD - AIF	1
B 3	79213	TRANSDUCER-PRESSURE 30 PSI	1
4	79596-XXXX	GATEWAY PC BOARD (See chart below).....	1
B 6*	82914	ASSY-EMC FILTER BOARD - CE	1
B 7*		BLOCK -TERMINAL POWER - CE.....	1

Part No.	Voltage	Coupling	Transceiver Type	Model
79596-1202	115	LN	NON-CENELEC	LVG-102
79596-1203	115	LN	NON-CENELEC	LVG-103
79596-1204	115	LN	NON-CENELEC	LVG-104
79596-2202	230	LN	NON-CENELEC	LVG-102
79596-2203	230	LN	NON-CENELEC	LVG-103
79596-2204	230	LN	NON-CENELEC	LVG-104
79596-2212	230	LN	CENELEC	LVG-102
79596-2213	230	LN	CENELEC	LVG-103
79596-2214	230	LN	CENELEC	LVG-104

Recommend Parts: A=Truck Stock/B=Dist. Stock / *not shown



Located behind motor

1

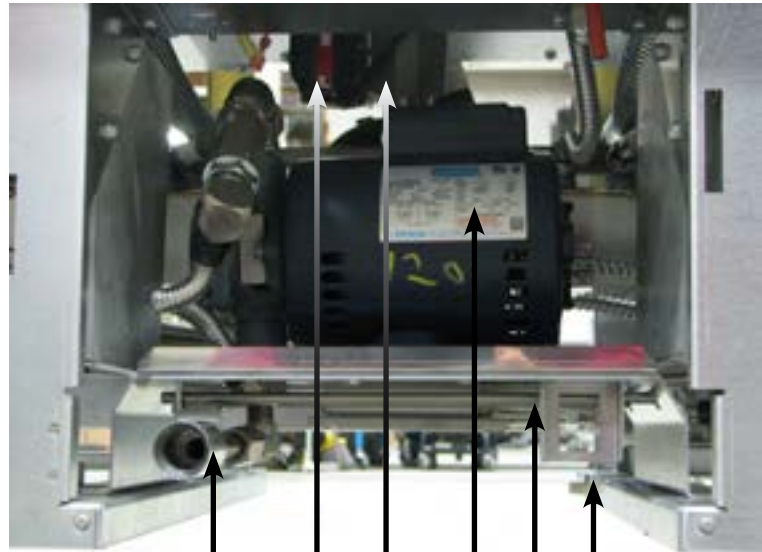

3 6 5 2 7 4

Item No.	Part No.	Description	Quantity
B 1	73473	PUMP - OIL TOP OFF - 120V	1
B 1	74583	PUMP - OIL TOP OFF - 230V	1
A 2	67583	MOTOR, 1/2 HP- 50/60 Hz.....	1
		see next page for parts break down	
3	83429	ADAPTER- TUBE END	1
A 4	87511	SWITCH- DRAIN PAN.....	1
B 5	140244	KIT- DRAIN VALVE W/O MODULE.....	AR
B 6	86157	MOTOR-ACTUATOR.....	AR
7	151486	ROD-FILTER PUMP BRACKET	2
8*	PN01-034	COTTER-PIN HAIR PIN	2
B 9*	90506-002	VALVE- CHECK SAE 12 35 PSI.....	1
B 10*	76948	O-RING (located in drain tube in trough).....	1/vat
B 11*	80728	FILTER- EMI (230V units only)	1
12*	151686-001	HOSE-OIL DISPOSAL	1
13*	140272	KIT-LVG200 PUMP PRIME	1

Recommend Parts: A=Truck Stock/B=Dist. Stock / *not shown

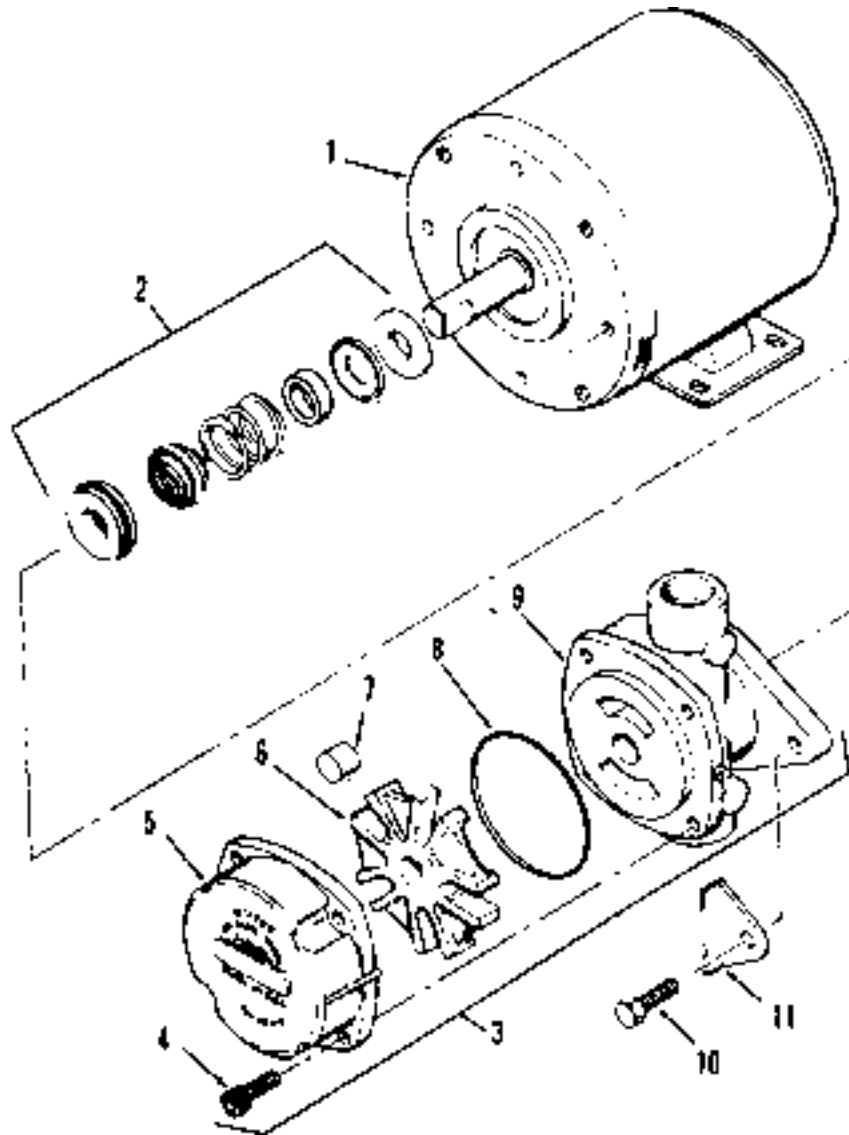

Filter Motor and Pump

Item No.	Part No.	Description	Quantity
	151534-001	ASSY-FILTER PMP & 1/2 HP MOTOR.....	1
	67589	ASSY-FILTER PMP & 1/2 HP MOTOR.....	1
A 1	67583	MOTOR, 1/2 HP - 50/60 Hz.....	1
A 2	17476	SEAL KIT.....	1
B 3	17437	PUMP ASSEMBLY.....	1
4	SC01-132	SCREW, Pump Cover.....	1
5	17451	COVER, Pump.....	1
B 6	17447	ROTOR, Pump.....	1
A 7	17446	ROLLER, Pump.....	5
A 8	17453	O-RING.....	1
9	17454	BODY, Pump.....	1
10	17456	SHIELD, Pump.....	2
11	SC01-026	SCREW, Pump Shield.....	1

Recommend Parts: A=Truck Stock/B=Dist. Stock / *not shown



1

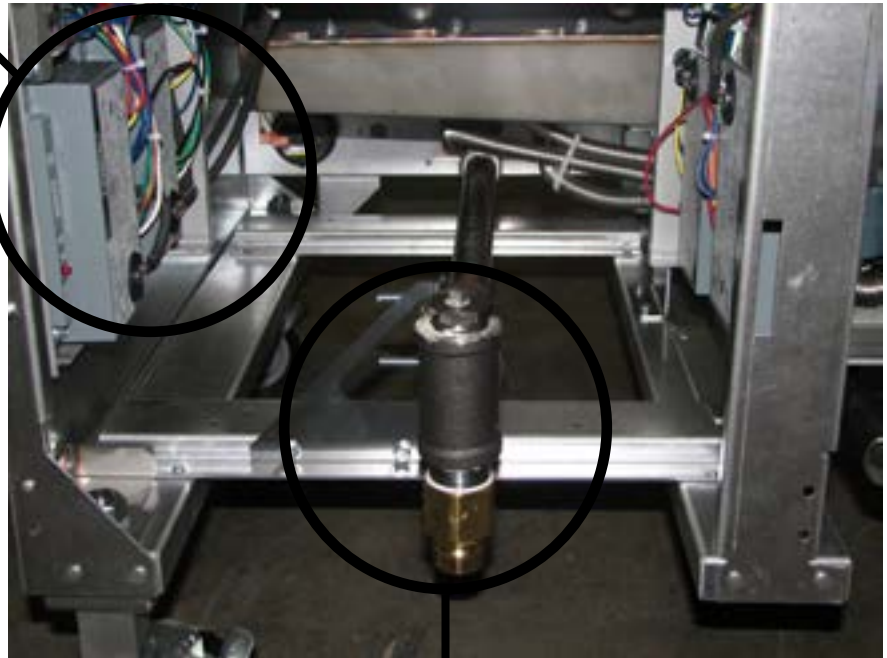

See Next page for parts

Item No.	Part No.	Description	Quantity
A 1	77839	MODULE- IGNITION NON CE	2/ WELL
A 1	77602	MODULE- IGNITION CE	2/ WELL

Recommend Parts: A=Truck Stock/B=Dist. Stock / *not shown

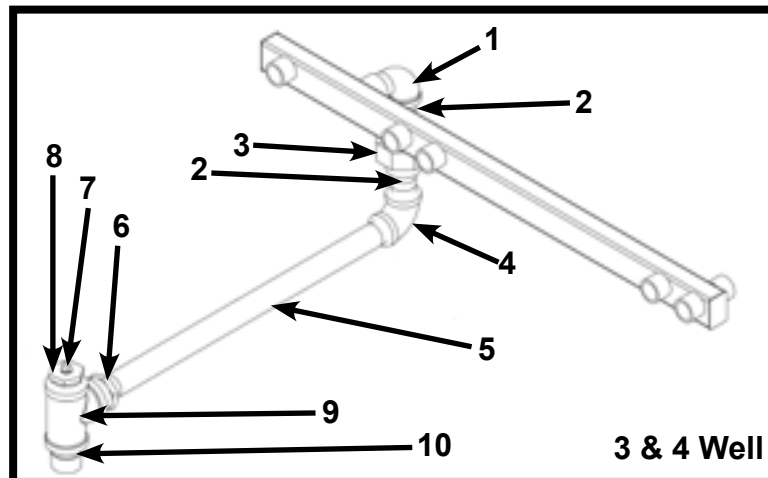
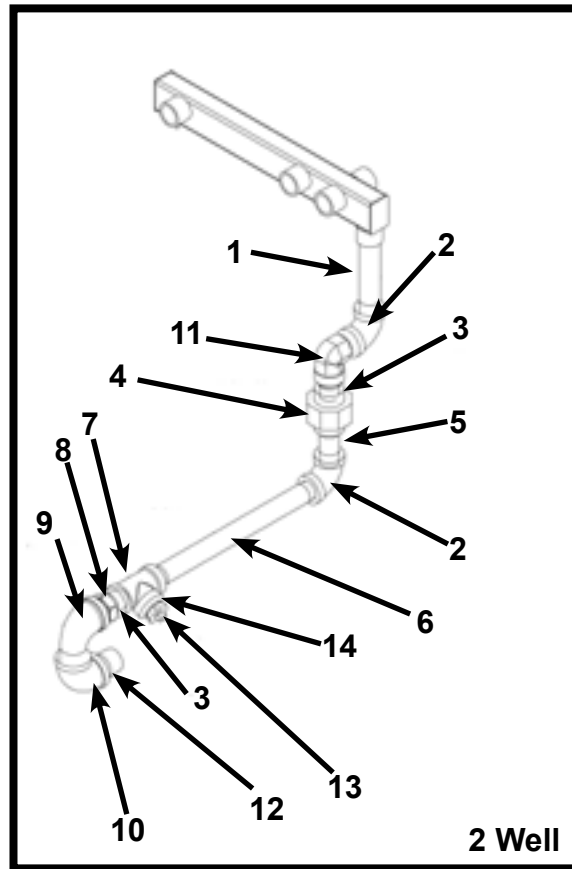

2 WELL

Item No.	Part No.	Description	Quantity
1	FP02-047	NIPPLE- 1/2 X 4 1/2 LONG	1
2	FP01-090	ELBOW-1/2 X 90 FEMALE	2
3	FP01-023	NIPPLE- 1/2 INCH CLOSE	2
4	FP01-150	UNION- 1/2 THREADED.....	1
5	FP01-018	1/2 STR PIPE COUPLING.....	1
6	FP02-071	FITTING- 1/2 BARB-F 1/2 NPT BRASS.....	1
7	FP01-112	1/2 NPT FEMAL PIPE TEE.....	1
8	FP01-078	REDUCER 3/4 MALE TO 1/2 FEMALE	1
9	FP01-100	ELBOW-STREET 3/4 NPT	1
10	FP01-098	ELBOW- 3/4 NPT X 90 FEMALE.....	1
11	16239	ELBOW STREET 90 DEGREE	1
12	16282	NIPPLE 3/4 X CLOSE	1
13	FP01-220	1/8 PIPE PLUG.....	1
14	FP01-215	REDUCING BUSHING- 1/2-1/8	1

3 & 4 WELLS

Item No.	Part No.	Description	Quantity
1	FP01-100	ELBOW- 3/4 NPT	1
2	FP02-044	NIPPLE- 3/4 X 2 LG	2
3	FP01-141	UNION- 3/4 3000LB	1
4	FP01-098	ELBOW- 3/4 NPT X 90 FEMALE.....	1
5	FP02-032	NIPPLE- 3/4" NPT X 17 IN LONG	1
6	FP01-227	REDUCER 1" MALE TO 3/4" FEMALE.....	1
7	FP01-220	1/8 PIPE PLUG.....	1
8	FP01-214	REDUCING BUSHING- 1 INCH 1/8.....	1
9	FP01-086	TEE-1IN NPT FEMALE PIPE.....	1
10	FP01-083	NIPPLE- 1IN NPT CLOSE BLACK.....	1

Recommend Parts: A=Truck Stock/B=Dist. Stock / *not shown

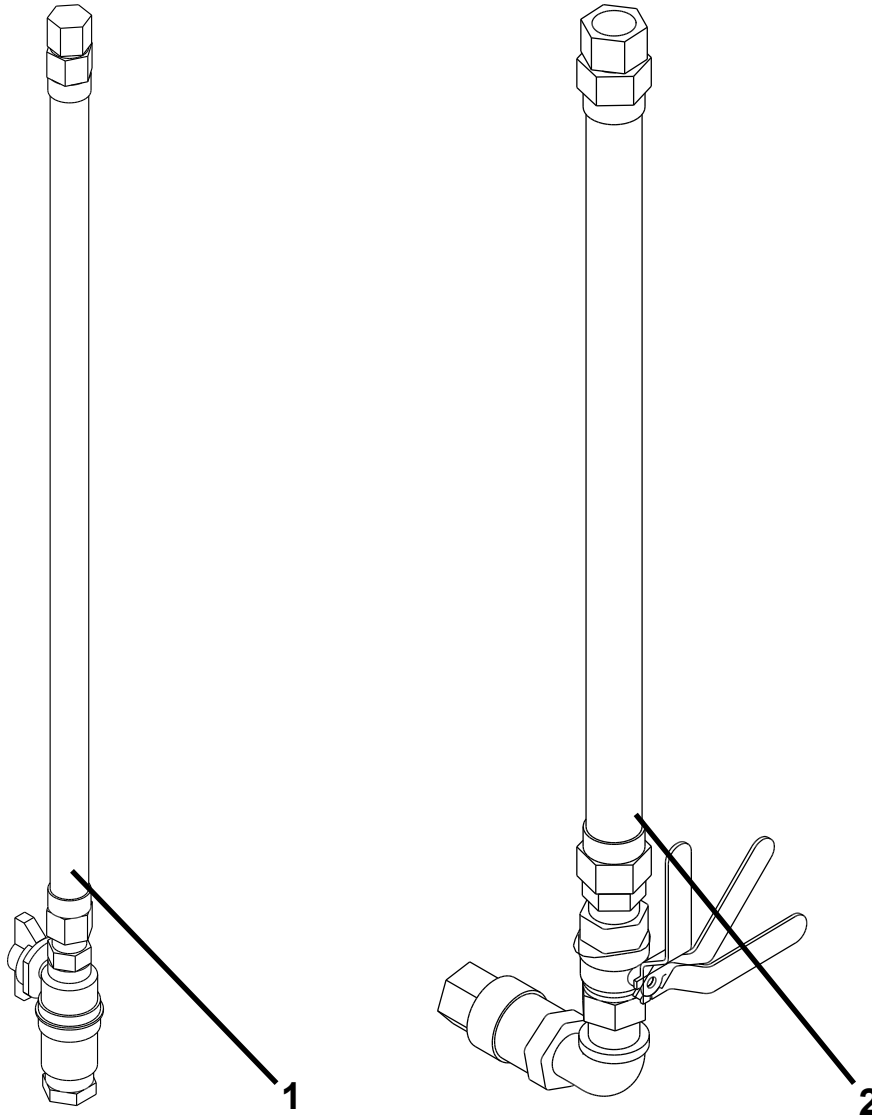

Item No.	Part No.	Description	Quantity
1	79327	FLEXIBLE GAS LINE W/SHUT-OFF VALVE - 2 -WELL-36 IN	1
2	77668-002	FLEXIBLE GAS LINE W/SHUT-OFF VALVE - 3 -WELL-72 IN	1

Recommend Parts: A=Truck Stock/B=Dist. Stock / *not shown

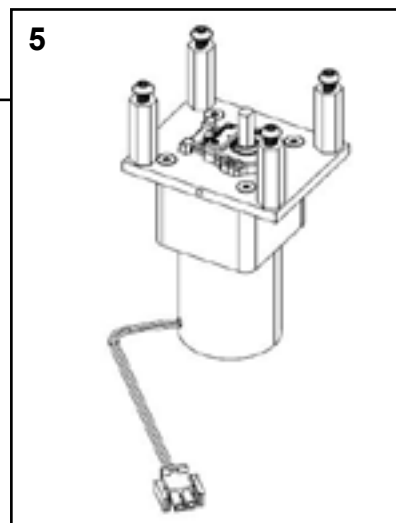
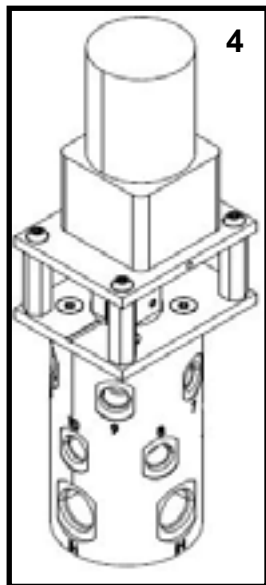
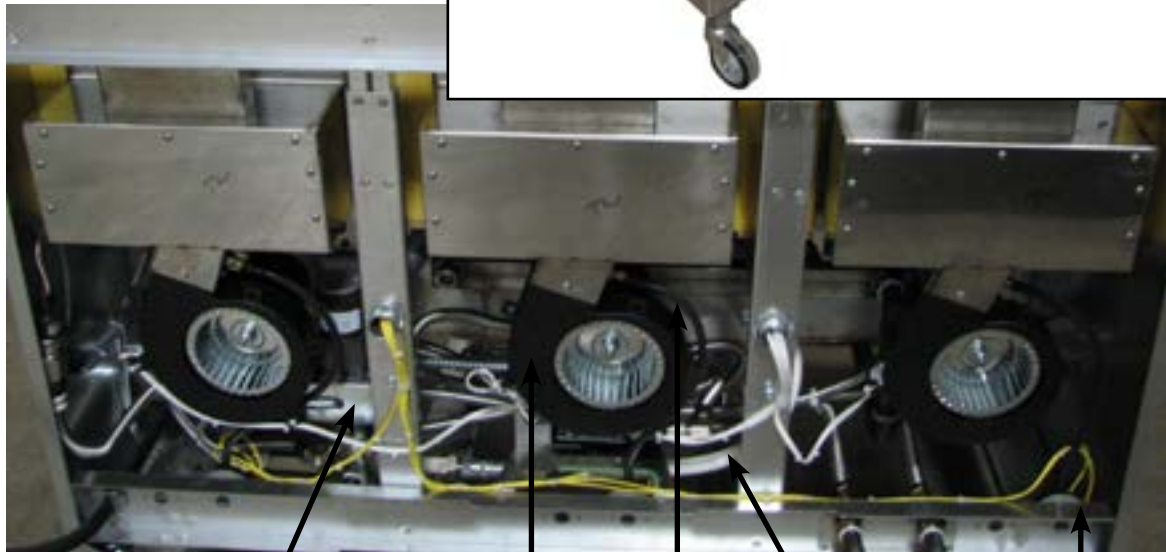
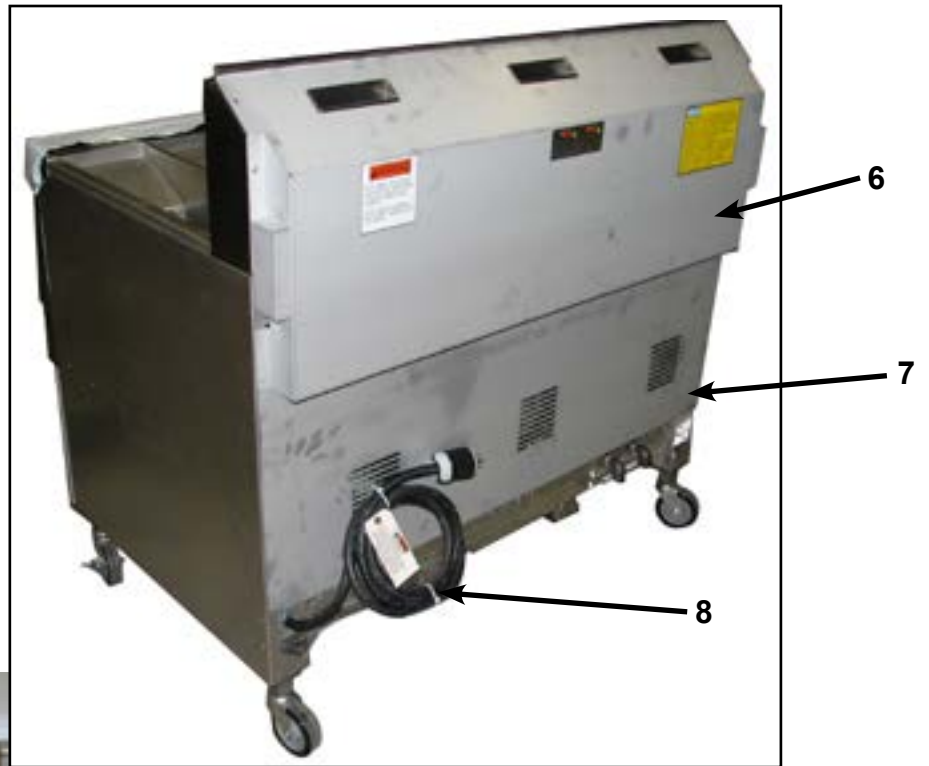

Item No.	Part No.	Description	Quantity
A 1	77992	SWITCH - PRESSURE - 0.80 (behind covers).....	1/vat
B 2	92963-001	MOTOR - BLOWER - 115V.....	1/ control board
B 2	92963-002	MOTOR - BLOWER - 230V.....	1/ control board
3	79443-X	TUBE - PRESSURE SWITCH (see chart below).....	AR
4	89405	SELECTOR VALVE.....	1
5	92627	ASSY-SEL VAL MOTOR ENCODER	1
		(Flex hose chart on next page)	
6	89445	COVER-REAR SHROUD LVG-202	1
6	86568	COVER-REAR SHROUD LVG-203	1
6	87558	COVER-REAR SHROUD LVG-204	1
7	89901	COVER- LOWER REAR LVG-202	1
7	86567	COVER- LOWER REAR LVG-203	1
7	87557	COVER- LOWER REAR LVG-204	1
8	79363	ASSY-CE CONT CORD & PLUG 230V.....	1
8	73517	ASSY- 120V POWER CORD	1
9*	82139	BAR-REAR SPACER-LVG-102.....	1
9*	80219	BAR-REAR SPACER-LVG-103.....	1
9*	83792	BAR-REAR SPACER-LVG-104.....	1
10	151686-002	HOSE-OIL DISPOSAL.....	1

PART NO.	“A”
79443-1	2.5”
79443-2	13”
79443-3	19”
79443-4	16”
79443-5	26”
79443-6	14”
79443-7	17”
79443-8	22”
79443-9	32”
79443-10	38”
79443-11	5.5”
79443-12	11”
79443-13	15”

Recommend Parts: A=Truck Stock/B=Dist. Stock / *not shown

SELECTOR VALVE
FLEX HOSES LENGTH/ PART
NUMBER

LVG-202				
Selector Valve Port	FF	SD SR SS	FD FR FS	SF
1	Plug	24"	Plug	30"
2	18"	18"	18"	24"
3	Plug	18"	18"	Plug
4	18"	18"	18"	18"
5	Plug	Plug	Plug	Plug
6	Plug	Plug	Plug	Plug
7	Plug	Plug	Plug	Plug
8	Plug	Plug	Plug	Plug
9 (JIB)	From JIB pump on line			
10 (RTI-Discard oil)	24"	24"	24"	24"
New Oil (RTI)	24"	24"	18"	18"
New Oil (From JIB)	From JIB pump on line			

LVG-203						
Selector Valve Port	FFF	SSD SSR SSS	FSD FSR FSS	FFD FFR FFS	SSF	SFF
1	Plug	36"	Plug	Plug	36"	36"
2	36"	30"	30"	30"	30"	30"
3	Plug	24"	24"	Plug	24"	Plug
4	18"	18"	18"	18"	18"	18"
5	Plug	18"	18"	18"	Plug	Plug
6	18"	18"	18"	18"	18"	18"
7	Plug	Plug	Plug	Plug	Plug	Plug
8	Plug	Plug	Plug	Plug	Plug	Plug
9	From JIB pump on line					
10 (RTI-Discard oil)	36"	36"	36"	36"	36"	36"
New Oil (RTI)	30"	30"	30"	30"	30"	30"
New Oil (From JIB)	From JIB pump on line					

LVG flex hose lengths and part numbers listed on next page

SELECTOR VALVE
FLEX HOSES LENGTH/ PART
NUMBER (CONTINUED)

LVG-204								
Selector Valve Port	FFFF	SSSD SSSR SSSS	FSSD FSSR FSSS	FFSD FFSSR FFSS	FFFD FFFR FFFS	SSSF	SSFF	SFFF
1	Plug	54"	Plug	Plug	Plug	54"	54"	54"
2	48"	48"	48"	48"	48	42"	42"	48"
3	Plug	36"	36"	Plug	Plug	36"	36"	Plug
4	30"	30"	30"	30"	30"	30"	30"	30"
5	Plug	24"	24"	24"	Plug	24"	Plug	Plug
6	24"	24"	24"	24"	24"	24"	24"	24"
7	Plug	18"	18"	18"	18"	Plug	Plug	Plug
8	18"	18"	18"	18"	18"	18"	18"	18"
9 (JIB)	From JIB pump on line							
10 (RTI- Discard Oil)	54"	54"	54"	54"	54"	54"	54"	54"
New Oil (RTI)	42"	42"	42"	42"	42"	42"	42"	42"
New Oil (From JIB)	From JIB pump on line							

LVG Flex Hose Lengths/ Part Number	
12" 77523-001	18" 77523-006
24" 77523-003	30" 77523-004
36" 77523-005	42" 77523-006
48" 77523-007	54" 77523-010

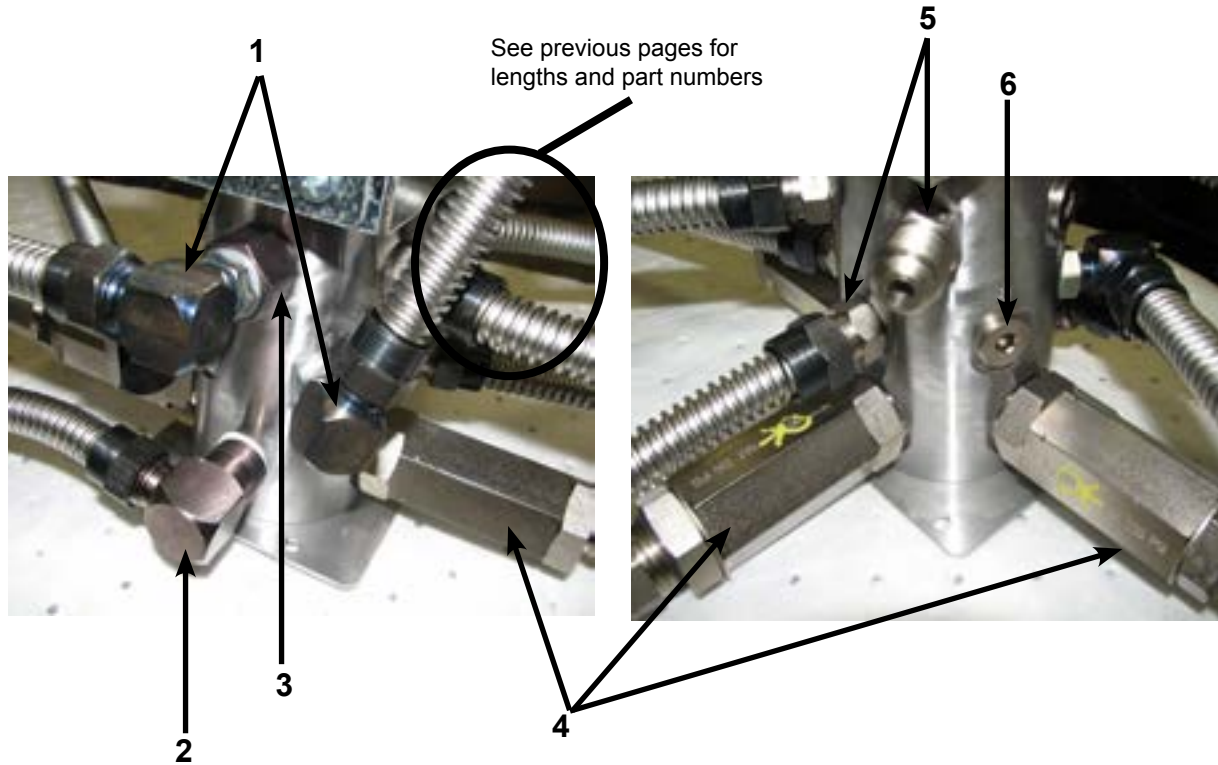

Item No.	Part No.	Description	Quantity
1	FP01-235	FTG-SAE ELBOW 45 DEG FLARE.....	A/R
2	FP01-205	ELBOW- 1/2 IN NPT MALE 45 FLARE	A/R
3	FP01-277	CONNECTOR-6 SAE M 6 SAE F.....	A/R
B 4	90506-001	VALVE- CHECK SAE 12 3 PSI	A/R
B 4	152165	ASSY-CHK VALVE PLUMBING (SN: BU1204119 & After)	1
	152161	-- ASSY- OIL MANF CHK VALVE.....	A/R
5	FP01-236	FTG-SAE STR 45 DEG FLARE.....	A/R
6	FP01-237	FTG- SAE PLUG	A/R
7*	96220	HARN-SELECTOR VLV ENCODER.....	1
8*	90479	HARN-SELECTOR VALVE-LVG20X.....	1

Recommend Parts: A=Truck Stock/B=Dist. Stock / *not shown

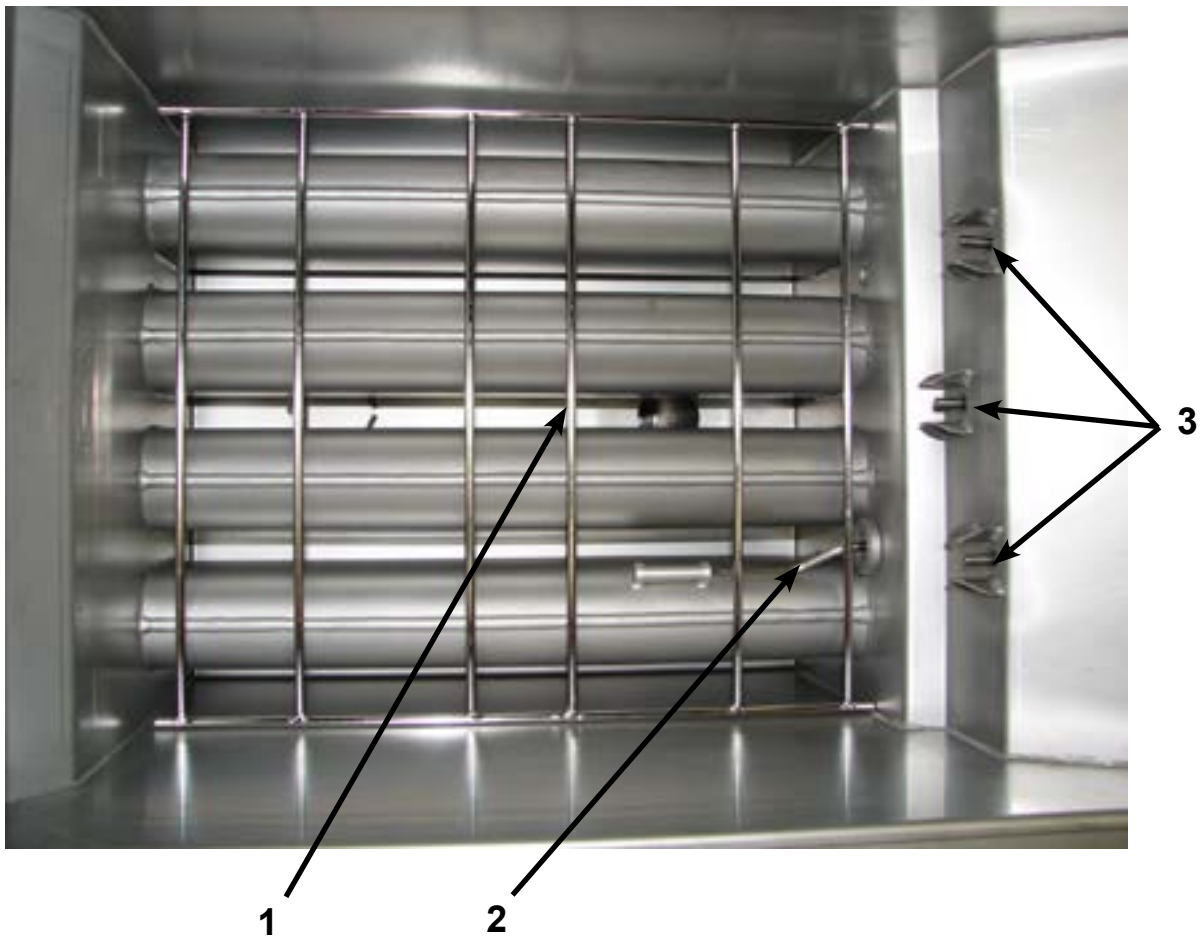

Item No.	Part No.	Description	Quantity
B 1	76980	RACK - SPLIT VAT	1/vat
B 1	76982	RACK - FULL VAT	1/vat
A 2	92717	THERMOCOUPLE - HIGH LIMIT.....	1/vat
B 3	140098	KIT- ASSY 2.5 INCH PROBE/ CAUGE	A/R
4*	140206	KIT-REPLACEMENT FULL POT ASSY.....	A/R
4*	140207	KIT-REPLACEMENT SPLIT POT ASSY.....	A/R

Recommend Parts: A=Truck Stock/B=Dist. Stock / *not shown

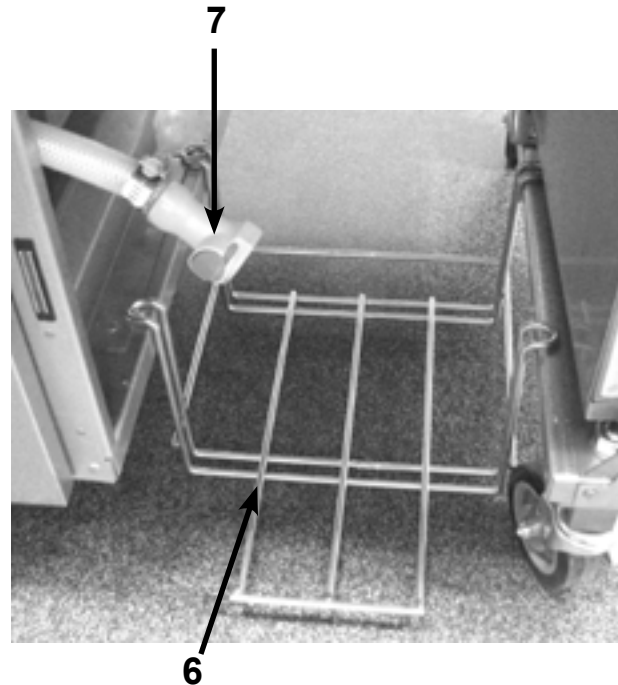
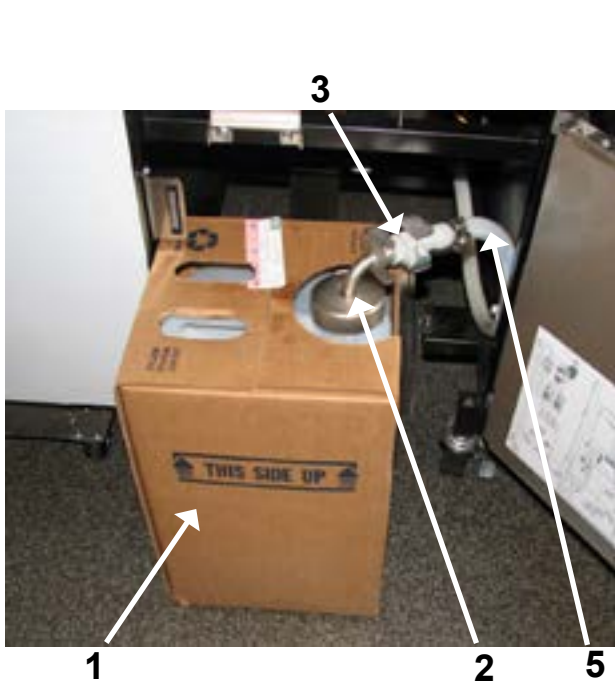

Item No.	Part No.	Description	Quantity
1	03617	ACCESSORY-JUG-AUTO TOP OFF (EMPTY).....	1
B 2	85738	ASSY-JIB TUBE & QUICK DISC (includes items 3 & 4).....	1
B 2	85737	ASSY-INT'L. JIB TUBE & QUICK DISC (includes items 3 & 4)	1
B 3	FP05-017	QUICK DISCONNECT - 3/8"	1
A 4*	MS01-561	O-RING - JIB TUBE	1
B 5	77288	ASSY - HOSE.....	1
6	83539	SHELF-JIB	1
7	FP05-017	QUICK DISCONNECT-3/8 (Male).....	1
8*	FP05-016	QUICK DISCONNECT-1/2 (Female).....	1

Recommend Parts: A=Truck Stock/B=Dist. Stock
*not shown

Recommend Parts: A=Truck Stock/B=Dist. Stock / *not shown

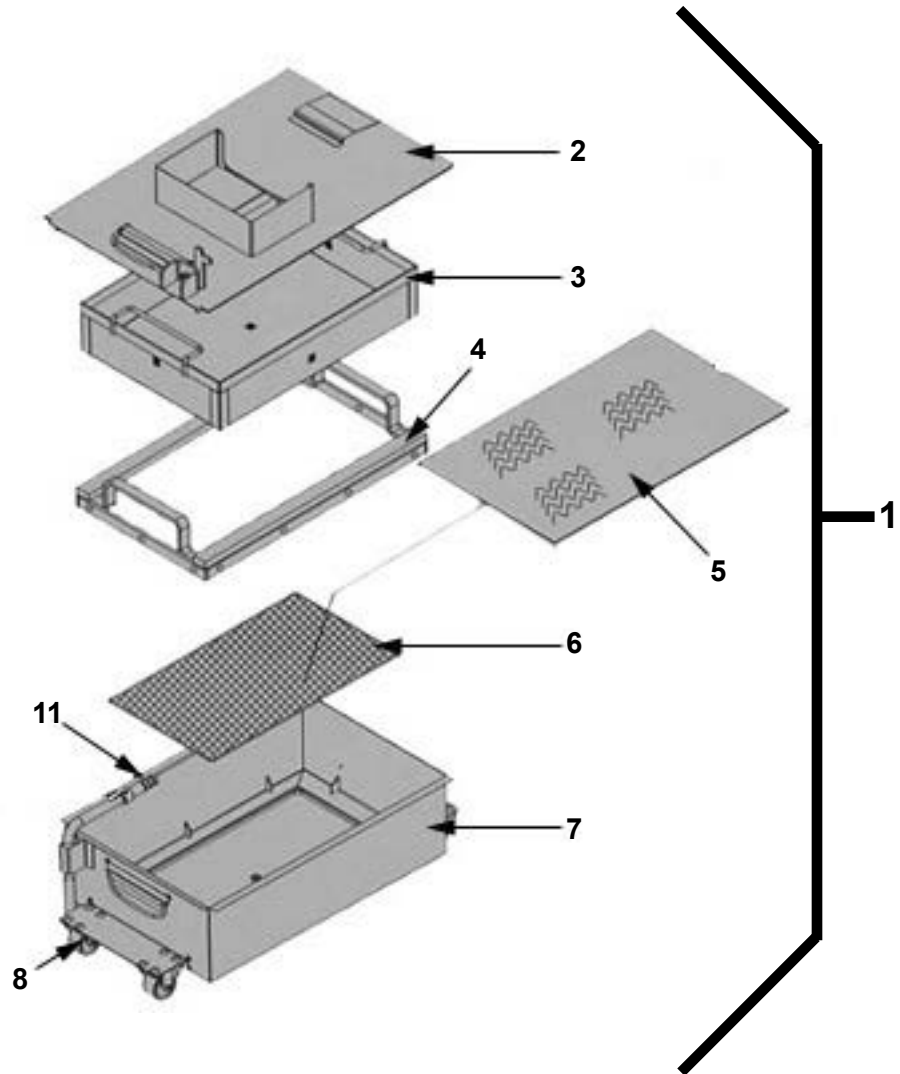

Item No.	Part No.	Description	Quantity
1	91185	ASSY - DRAIN PAN - LVG.....	1
2	152264	ASSY-DRAIN PAN COVER.....	1
3	85507	WELD ASSY-CRUMB CATCHER	1
4	85503	WELD ASSY-FILTER WEIGHT	1
5	03190-054	McD's FILTER KIT (not supplied by Henny Penny)..... (includes fryer cleaner, 30 filter pads, & green cleaner pads)	1
6	85519	FILTER-SECTION	1
7	95842	ASSY-DRAIN PAN & CASTERS-20X	1
8	19004	CASTER - DRAIN PAN.....	4
9*	SC01-009	SCREW (1/4-20 x 1/2).....	16
10*	NS04-005	NUT, KEPS (1/4-20).....	16
A 11	86349	O-RING-PICKUP TUBE.....	3
B 12	12126	BRUSH - BLACK L.....	1
B 13	12112	BRUSH - STRAIGHT WHITE	1
B 14	12116	BRUSH - FRYER - LONG HANDLE	1

Recommend Parts: A=Truck Stock/B=Dist. Stock / *not shown

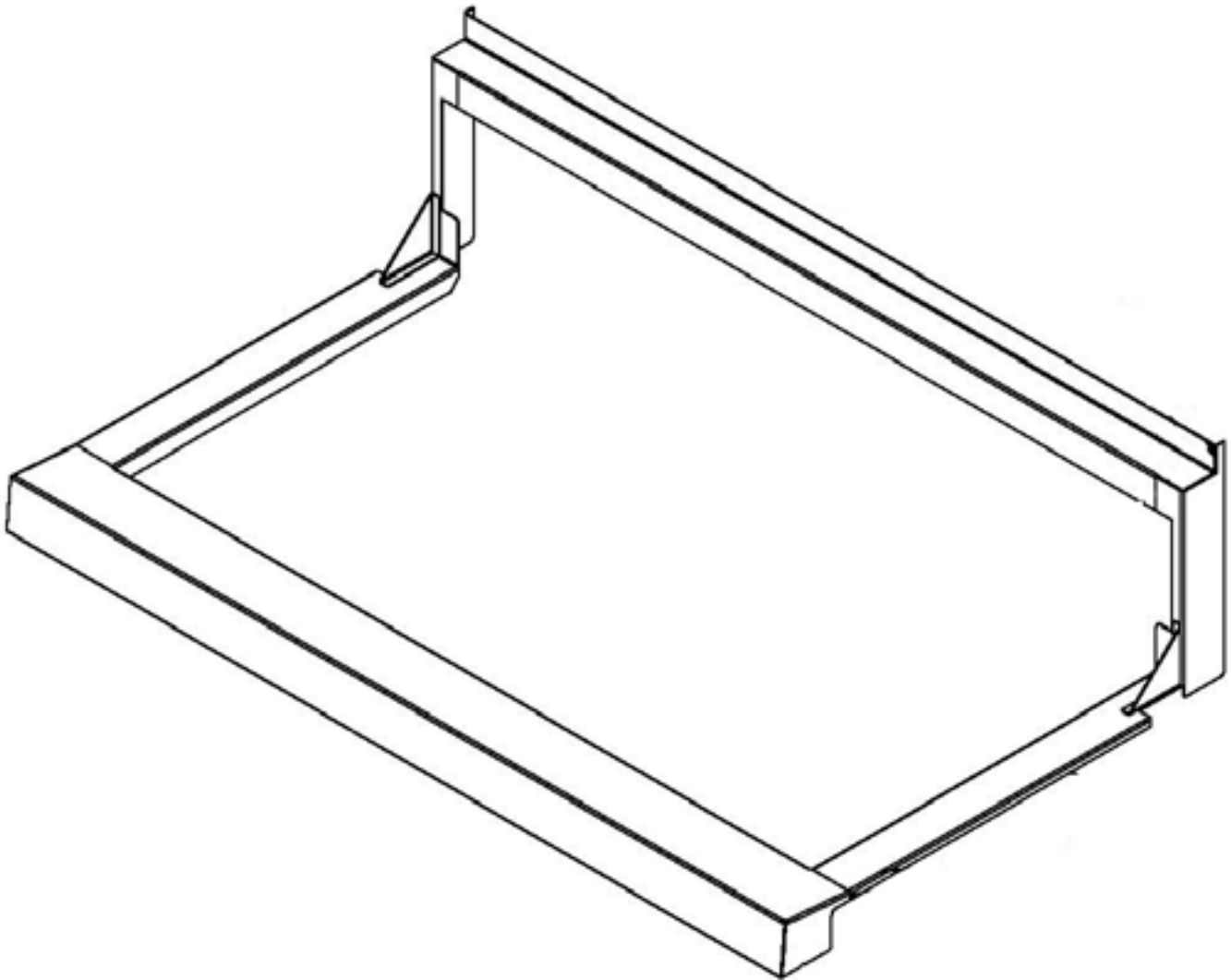

Fry Cap

Item No.	Part No.	Description	Quantity
1	03702	ACCESSORY-FRY CAP - LVG-202.....	1
1	03703	ACCESSORY-FRY CAP - LVG-203.....	1
1	03704	ACCESSORY-FRY CAP - LVG-204.....	1

Recommend Parts: A=Truck Stock/B=Dist. Stock / *not shown

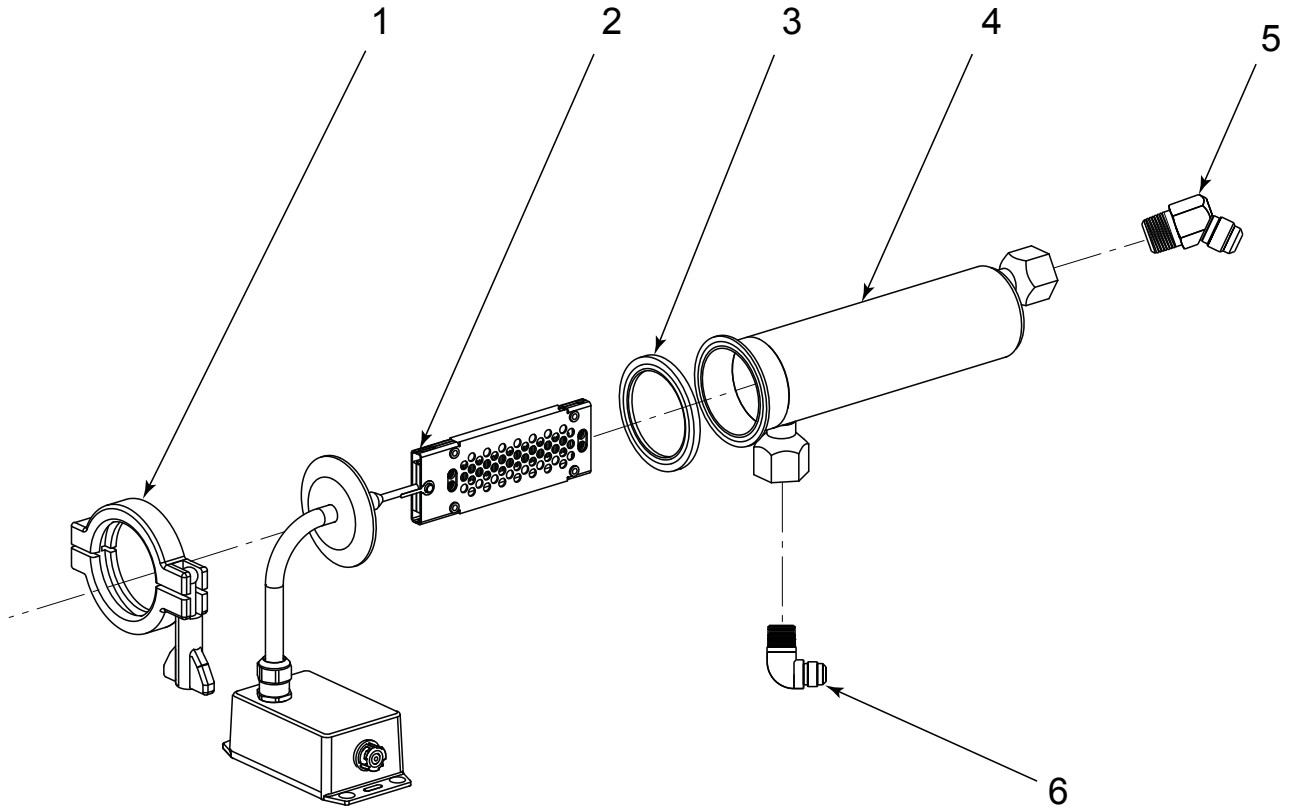

05160001

Oil Quality Monitoring (OQM) Sensor

Item No.	Part No.	Description	Quantity
1	154103	CLAMP, SENSOR OQM.....	1
2	154101	ASSY, OQM SENSOR & TUBE.....	1
3	154104	SEAL, SENSOR OQM.....	1
4	154102	WELD ASSY, OQM SENSOR BODY.....	1
5	FP01-278	ELBOW, 45 DEG 1/2 NPT M X #8 M	2
6	FP01-205	ELBOW, 1/2 IN NPT MALE 45 FLARE	1

APPENDIX A. WIRING DIAGRAMS AND SCHEMATICS

WIRING LEGEND

The legend below helps in identifying the components of the wiring diagrams on the following wiring diagrams.

ABBREV	DEFINITION
CM	COMMON
CP	CONTROL POWER
D	DRAIN PAN
FB	FILTER BOARD
FL	FILTER LIGHT
FN	FAN
GND	GROUND
GV	GAS VALVE
HL	HIGH LIMIT
J	JUMPER
JL	JIB LOW LIGHT
JM	JIB MOTOR
JV	JIB VALVE

ABBREV	DEFINITION
L1	LINE VOLTAGE
LDV	LEFT DRAIN VALVE
LDS	LEFT DRAIN SWITCH
LRV	LEFT RETURN VALVE
LW	LONWORKS
M	MOTOR
MLT1	MELTER LINE VOLTAGE
MLTN	MELTER NEUTRAL
MV	MAIN VALVE
N	NEUTRAL
PB	PROBE
PJ	POWER JUMPER
PS	POWER SWITCH

ABBREV	DEFINITION
PV	PILOT VALVE
R	RELAY
RDV	RIGHT DRAIN VALVE
RDS	RIGHT DRAIN SWITCH
RRV	RIGHT RETURN VALVE
RTIC	RTI CABLE
RTIK	RTI KEY
SEN	SENSOR, FLAME
SFTY	SAFETY VALVE
TH	IGNITION MODULE TH
TR	TRANSFORMER
VS	VACUUM SWITCH
-	EXT. OF SAME SIGNAL

