

**HENNY PENNY**™

*Global Foodservice Solutions*

**Henny Penny  
Pressure Fryer  
Model 580 KFC**

**SERVICE MANUAL**



# HENNY PENNY 8 HEAD PRESSURE FRYER

## Model 580 Electric Fryer

### SPECIFICATIONS

Height	60" (155 cm)
Width	24" (61 cm)
Depth	41" (104 cm)
Floor Space	Approximately 7 sq. ft. (.65 sq. m.)
Pot Capacity	8 Head of chicken (22 lbs.)(9.9 Kg.) 100 lbs. shortening (45.4 Kg.)
Electrical	120/208 VAC, 3 Phase, 50/60 Hz, 47.2 Amp, 17 KW 120/240 VAC, 3 Phase, 50/60 Hz, 40.9 Amp, 17 KW 200 VAC, 3 Phase, (Delta) 50/60 Hz, 49.1 Amp, 17 KW 240 VAC, 3 Phase, (Delta) 50 Hz, 40.9 Amp, 17 KW 380 VAC, 3 Phase, 50 Hz, 25.8 Amp, 17 KW 415 VAC, 3 Phase, 50 Hz, 23.7 Amp, 17 KW
Heating	Two 8,500 Watt Electric Immersion Elements
Pressure	12 PSI operating pressure (827 mbar) 14.5 PSI safety relief pressure (999 mbar)
Shipping Weight	Approximately 600 lbs. (226.8 Kg.)

### NOTE

A data plate, located on the right side panel, gives the information of the type of fryer, serial number, warranty date, and other information pertaining to fryer. Also, the serial number is stamped on the outside of the cookpot. See figure below.

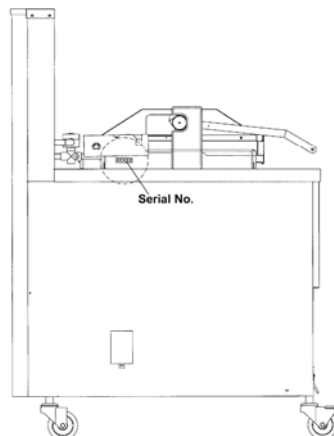

## **LIMITED WARRANTY FOR HENNY PENNY APPLIANCES**

Subject to the following conditions, Henny Penny Corporation makes the following limited warranties to the original purchaser only for Henny Penny appliances and replacement parts:

**NEW EQUIPMENT:** Any part of a new appliance, except lamps and fuses, which proves to be defective in material or workmanship within two (2) years from date of original installation, will be repaired or replaced without charge F.O.B. factory, Eaton, Ohio, or F.O.B. authorized distributor. To validate this warranty, the registration card for the appliance must be mailed to Henny Penny within ten (10) days after installation.

**REPLACEMENT PARTS:** Any appliance replacement part, except lamps and fuses, which proves to be defective in material or workmanship within ninety (90) days from date of original installation will be repaired or replaced without charge F.O.B. factory, Eaton, Ohio, or F.O.B. authorized distributor.

The warranty for new equipment and replacement parts covers only the repair or replacement of the defective part and does not include any labor charges for the removal and installation of any parts, travel or other expenses incidental to the repair or replacement of a part.

**EXTENDED FRYPOT WARRANTY:** Henny Penny will replace any frypot that fails due to manufacturing or workmanship issues for a period of up to seven (7) years from date of manufacture. This warranty shall not cover any frypot that fails due to any misuse or abuse, such as heating of the frypot without shortening.

**0 TO 3 YEARS:** During this time, any frypot that fails due to manufacturing or workmanship issues will be replaced at no charge for parts, labor, or freight. Henny Penny will either install a new frypot at no cost or provide a new or reconditioned replacement fryer at no cost.

**3 TO 7 YEARS:** During this time, any frypot that fails due to manufacturing or workmanship issues will be replaced at no charge for the frypot only. Any freight charges and labor costs to install the new frypot as well as the cost of any other parts replaced, such as insulation, thermal sensors, high limits, fittings, and hardware, will be the responsibility of the owner.

Any claim must be represented to either Henny Penny or the distributor from whom the appliance was purchased. No allowance will be granted for repairs made by anyone else without Henny Penny's written consent. If damage occurs during shipping, notify the sender at once so that a claim may be filed.

THE ABOVE LIMITED WARRANTY SETS FORTH THE SOLE REMEDY AGAINST HENNY PENNY FOR ANY BREACH OF WARRANTY OR OTHER TERM. BUYER AGREES THAT NO OTHER REMEDY (INCLUDING CLAIMS FOR ANY INCIDENTAL OR CONSEQUENTIAL DAMAGES) SHALL BE AVAILABLE.

The above limited warranty does not apply (a) to damage resulting from accident, alteration, misuse, or abuse; (b) if the equipment's serial number is removed or defaced; or (c) for lamps and fuses. THE ABOVE LIMITED WARRANTY IS EXPRESSLY IN LIEU OF ALL OTHER WARRANTIES, EXPRESS OR IMPLIED, INCLUDING MERCHANTABILITY AND FITNESS, AND ALL OTHER WARRANTIES ARE EXCLUDED. HENNY PENNY NEITHER ASSUMES NOR AUTHORIZES ANY PERSON TO ASSUME FOR IT ANY OTHER OBLIGATION OR LIABILITY.

## TABLE OF CONTENTS

Section	Page
Section 1. INTRODUCTION .....	1-1
1-1. Pressure Fryer .....	1-1
1-2. Proper Care .....	1-1
1-3. Assistance .....	1-1
1-4. Safety .....	1-2
Section 2. INSTALLATION .....	2-1
2-1. Unpacking Instructions .....	2-5
2-2. Selecting the Fryer Location .....	2-5
2-3. Leveling the Fryer .....	2-5
2-4. Ventilation of Fryer .....	2-5
2-5. Electrical Requirements .....	2-5
2-6. Testing the Fryer .....	2-6
2-7. Operational Checks .....	2-6
2-8. International Electrical Requirements .....	2-7
Section 3. OPERATION .....	3-1
3-1. Operating Controls .....	3-1
3-2. Lid Operation .....	3-3
3-3. Melt Cycle, Operation .....	3-5
3-4. Filling or Adding Shortening .....	3-5
3-5. Filtering Instructions .....	3-6
3-6. Switches and Indicators .....	3-8
3-7. Fryer Power Mode .....	3-9
3-8. Mode Selection to Filter Shortening .....	3-9
3-9. Start-Up .....	3-10
3-10. Cleaning the Frypot .....	3-11
Section 4. TROUBLESHOOTING .....	4-1
4-1. Introduction .....	4-1
4-2. Troubleshooting .....	4-1
Section 5. MAINTENANCE .....	5-1
5-1. Introduction .....	5-1
5-2. Arrangement .....	5-1
5-3. Maintenance Hints .....	5-1
5-4. Electrical Components .....	5-1
5-5. High Temperature Limit Control .....	5-2
5-6. Fuse Holders .....	5-4
5-7. Cook/Pump Switch .....	5-5
5-8. Contactors .....	5-6
5-9. Heating Elements .....	5-8
5-10. Drain Switch .....	5-10

## TABLE OF CONTENTS

<b>Section</b>	<b>Page</b>
5-11. Temperature Probe.....	5-10
5-12. Complete Control Panel.....	5-12
5-13. Pressure Regulation.....	5-12
5-14. Preventive Maintenance.....	5-13
5-15. Reversing the Lid Gasket.....	5-13
5-16. Lid Counterweight.....	5-14
5-17. Pressure Pads.....	5-16
5-18. Lid Adjustment.....	5-16
5-19. Adjusting the Magnet Plate (SN: GG015JJ and below).....	5-18
5-20. Solenoid Valve Replacement.....	5-18
5-21. Operating Control Valve.....	5-20
5-22. Removal & Cleaning of Safety Valve.....	5-21
5-23. Pressure Gauge.....	5-22
5-24. Drain Valve.....	5-23
5-25. Nylatron Strips.....	5-24
 Section 6. PROGRAMMING.....	 6-1
6-1. Basic Programming Sequence.....	6-1
6-2. Cook Cycle.....	6-1
6-3. Error Codes.....	6-2
6-4. Special Programming Modes.....	6-2
6-5. One Step KFC Parameters.....	6-3
6-6. Test Procedures.....	6-3
6-7. Special Functions.....	6-4
Parts Section.....	6-5
Wiring Diagrams.....	6-20
SMS Programming (If Applicable).....	6-34

**SECTION 1. INTRODUCTION**

**1-1. PRESSURE FRYER**

The Henny Penny Pressure Fryer is a basic unit of food processing equipment. It has found wide application in institutional and commercial food service operations.

**P-H-T**

A combination of Pressure, Heat, and Time is automatically controlled to produce the optimum in a tasty, appealing product.

**PRESSURE**

Pressure is basic to this method of food preparation. The pressure is developed from the natural moisture of the food. The patented lid traps this moisture and uses it as steam. Because the steam builds rapidly, the greater part of the natural juices are retained within the food. An operation valve vents excess steam from the pot and maintains constant live steam pressure.

**HEAT**

Heat generated is another important factor of the pressure fryer. Energy savings is realized due to the unit's short frying time, low temperature, and heat retention of the stainless steel cookpot.

**TIME**

Time is important because the shorter time involved in frying foods results in additional economies for the user. Foods are table ready in less time than it would take to fry them in a conventional open-type fryer.

**1-2. PROPER CARE**

As in any unit of food service equipment, the Henny Penny Pressure fryer does require care and maintenance. Requirements for the maintenance and cleaning are contained in this manual and must become a regular part of the operation of the unit at all times.

**1-3. ASSISTANCE**

Should you require outside assistance, just call 1-800-417-8417, or 937-417-8417.

1-4. SAFETY

The Henny Penny Pressure Fryer has many safety features incorporated. However, the only way to ensure a safe operation is to fully understand the proper installation, operation, and maintenance procedures. The instructions in this manual have been prepared to aid you in learning the proper procedures. Where information is of particular importance or safety related, the words DANGER, WARNING, CAUTION, and NOTE are used. Their usage is described below.



The word DANGER indicates an imminent hazard which will result in highly serious injury such as second or third degree burns, loss of sight, and other permanent injuries.



The word WARNING is used to alert you to a procedure, that if not performed properly, might cause personal injury, such as burns and/or loss of sight, and damage to the fryer.



The word CAUTION is used to alert you to a procedure that, if not performed properly, may damage the fryer, or product.

**NOTE**

The word NOTE is used to highlight especially important information.

**SECTION 2. INSTALLATION****2-1. UNPACKING  
INSTRUCTIONS**

1. Cut and remove the metal bands from the carton.
2. Remove the carton lid and lift the main carton off the fryer.
3. Remove corner packing supports (4).
4. Cut and remove the metal bands holding the fryer to the pallet.

**WARNING**

Do not unlatch the lid before completion of steps 5, 6, and 7.

5. Remove the fryer from the pallet. See page 2-3.

**WARNING**

The fryer weighs approximately 600 lbs. (273 KG). Extreme care should be taken when moving the fryer to prevent personal injury.

6. Remove rear cover.
7. Load the Counterweight Assembly. See page 2-4.
8. Replace rear cover.
9. Cut warning tags from the lid assembly. The lid may now be unlatched.
10. Prepare the deadweight valve for operation.

**CAUTION**

The metal shipping support is placed inside the deadweight valve housing to protect the orifice and weight during shipment. This support must be removed prior to installation and start-up.

- A. Unthread the top cap.
- B. Remove the round weight.
- C. Remove and discard the shipping support.
- D. Clean the orifice with a dry cloth.
- E. Replace the weight and secure the top cap.

**2-1. UNPACKING  
INSTRUCTIONS  
(Continued)**

11. Open lid and remove packing and racks from inside of cookpot.
12. Remove the protective paper from the fryer cabinet. It is necessary to clean exterior surface with a damp cloth.

**WARNING**

THE FRYER WEIGHS APPROXIMATELY 600 LBS.  
(273 KG). EXTREME CARE MUST BE TAKEN  
WHEN MOVING THE FRYER TO PREVENT  
PERSONAL INJURY.

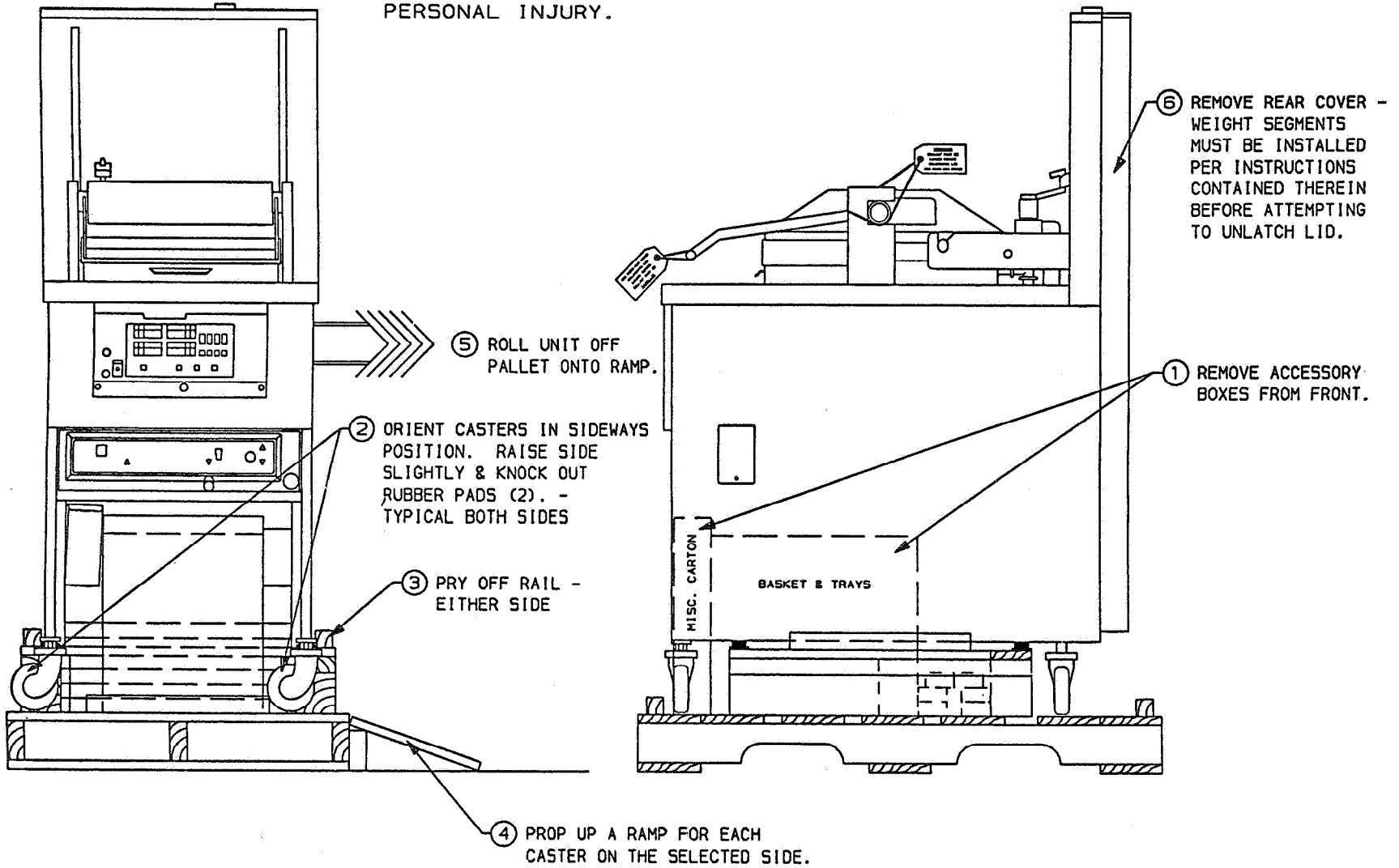

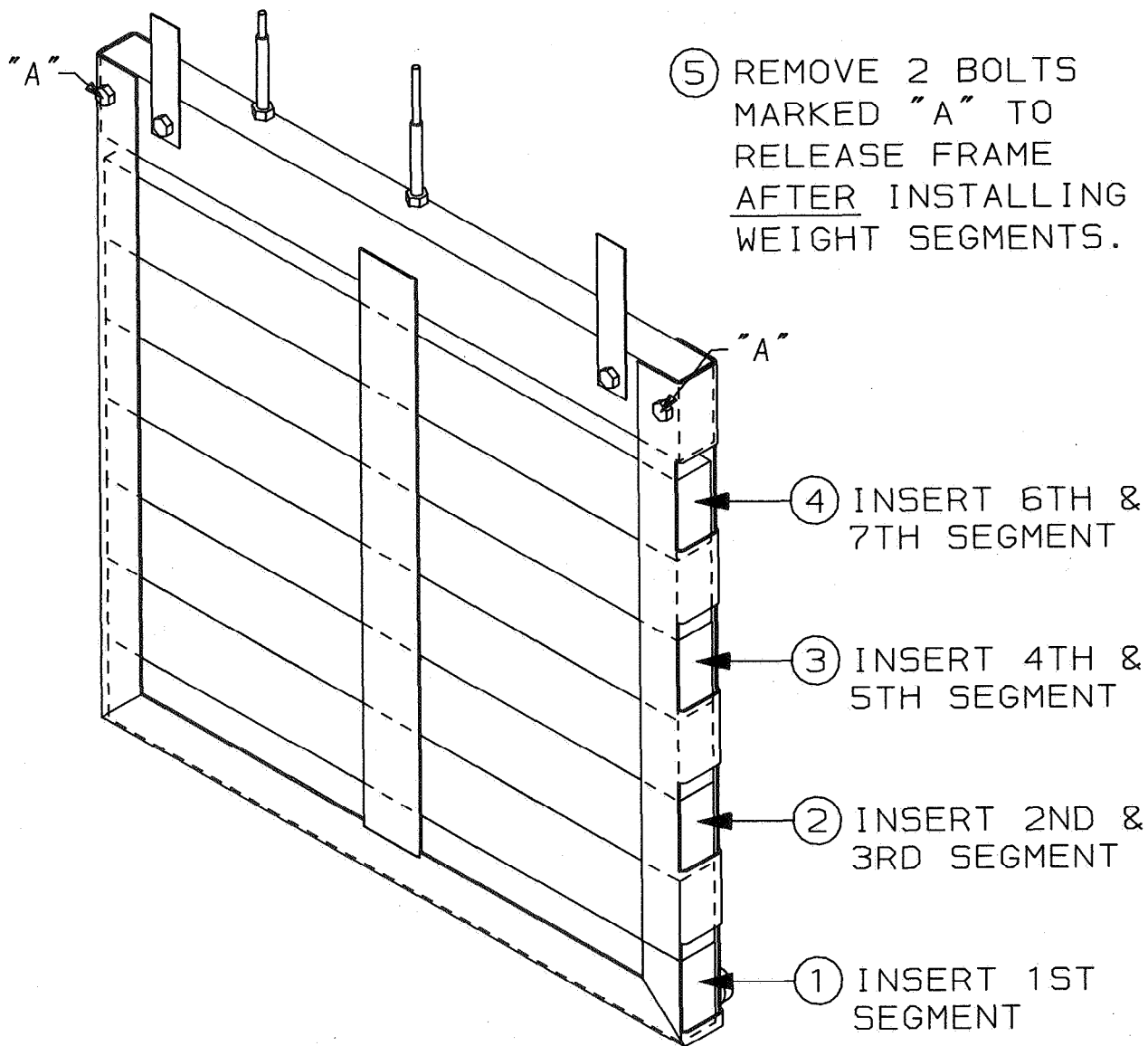

WARNING!

- \* EACH WEIGHT SEGMENT WEIGHS APPROXIMATELY 18 LBS. (8.1 KG) - HANDLE WITH CARE.
- \* ALL SEGMENTS ARE IDENTICAL.
- \* ALL SEGMENTS MUST BE INSTALLED AND SECURED IN THE FRAME BEFORE ATTEMPTING TO UNLATCH LID.

## 2-2. SELECTING THE FRYER LOCATION

The proper location of the fryer is very important for operation, speed, and convenience. Choose a location which will provide easy loading and unloading without interfering with the final assembly of food orders. Operators have found that frying from raw to finish, and holding the product in warmers provides fast continuous service. Landing or dumping tables should be provided next to at least one side of the straight line operation, i.e. raw in one side and finish out the other side. Other assembly can be moved away with only a slight loss of efficiency.

## 2-3. LEVELING THE FRYER

For proper operation, the fryer must be level from side to side and front to back. Using a level placed on the flat areas around the frypot collar, adjust the leveling bolt or casters until the unit is level.

## 2-4. VENTILATION OF FRYER

The fryer should be located with provision for venting into adequate exhaust hood or ventilation system. This is essential to permit efficient removal of the steam exhaust and frying odors. Special precaution must be taken in designing an exhaust canopy to avoid interference with the operation of the fryer. Make certain the exhaust allows for proper opening of the fryer lid. We recommend you consult a local ventilation or heating company to help in designing an adequate system.

## 2-5. ELECTRICAL REQUIREMENTS

The electric fryer is available from the factory wired for 208/120, 240/120 volts, three phase 60 Hz. service. The power cord may be already attached to the fryer, or provided at installation. Check the data plate on the right side of the fryer to determine the correct power supply.

**WARNING**

This fryer must be adequately and safely grounded. Refer to local electrical codes for correct grounding procedures. If fryer is not adequately grounded, electrical shock could result.

A separate disconnect switch with proper capacity fuses or breakers must be installed at a convenient location between the fryer and the power source. It should be an insulated copper conductor rated for 600 volts and 90°C. For runs longer than 50 feet, use the next larger size wire.

**CAUTION**

The main power switch on this appliance does not disconnect all line conductors. This appliance must be equipped with an external circuit breaker which will disconnect all ungrounded conductors.

**2-6. TESTING THE FRYER**

Each Henny Penny pressure fryer was completely checked and tested prior to shipment. However, it is good practice to check the unit again after installation.

**2-7. OPERATIONAL CHECKS**

1. Cook a round of product.
2. Check to see that the indicator needle in the pressure gauge is reading in the "Operating Zone".

**WARNING**

Should the pressure gauge read beyond the "Operating Zone" turn the Power/Pump switch to the "OFF" position and refer to the Operation Control Valve Section. Continued use of the unit at this high pressure could result in serious injuries and severe burns.

3. Make sure lid gasket is not leaking, and no steam is coming from safety relief valve.
4. Check the drain valve and fill line check valve for leaks.
5. Depressurization starts before end of cycle.
6. At the end of the cook cycle:
  - The control will sound off by beeping.
7. Push the cycle button.
8. When all the pressure has exhausted (observe pressure gauge) open the lid.



**DO NOT ATTEMPT TO OPEN LID UNTIL THE PRESSURE DROPS TO ZERO.** Opening the lid when the cookpot is pressurized will allow hot shortening and moisture to escape from the cookpot, resulting in severe burns.

9. Let rack hang for 3-5 seconds, then proceed to take out racks of chicken and place onto a bun pan.

If all the above functions have been performed satisfactorily the fryer is ready for operation.

**WARNING**

All operators, as well as maintenance and management personnel, must thoroughly read and understand the Operation Section prior to putting the fryer into operation. Failure to adhere to these instructions could result in serious bodily injury or property damage.

## 2-8. INTERNATIONAL ELECTRICAL REQUIREMENTS

Units being used outside the United States may not be shipped with the power cord attached to the unit because of the different wiring codes. The fryers are available from the factory wired for 208, 240, 380 and 415 volts, 3 phase, 50 Hertz service. A terminal block is mounted inside the fryer for the cable wiring. A decal on the inside of the right side panel will help in the wiring of the unit.

To install the power cord, follow these procedures:

1. Remove the side panel from the right side of the unit.
2. Remove the front panel, behind the filter knob and quick disconnect.
3. Thread the cable through the strain relief on the junction box.
4. Attach the wires to the terminal block according to the wiring diagram on the side panel.
5. Pull the slack out of the cable and tighten the screws on the strain relief.
6. Pull the slack out of the cable and secure it with the clamp on the back of the cookpot.

### NOTE

Be sure the cable doesn't sag, or it could interfere with the use of the portable filter.

7. Pull the slack out of the cable and secure it with the clamp on the frame, at the rear, right leg of fryer.

### WARNING

Be sure enough slack is out of the cable so it doesn't extend out past the portable filter stop bracket at the bottom of the fryer frame. The cable could interfere with the portable filter, not allowing it to be pushed all the way in. This could cause hot shortening to spill onto the floor.

8. Wiring the fryer is now complete.

**BOIL-OVER PREVENTION  
IN HENNY PENNY EIGHT HEAD COOKERS**



FAILURE TO FOLLOW THESE INSTRUCTIONS CAN RESULT IN SHORTENING OVERFLOWING THE COOKPOT, WHICH COULD CAUSE SERIOUS BURNS, PERSONAL INJURY, FIRE AND/OR PROPERTY DAMAGE.

- THE SHORTENING MAY BE STIRRED ONLY DURING THE MORNING START UP PROCEDURE. **DO NOT STIR THE SHORTENING AT ANY OTHER TIME.**
- FILTER THE SHORTENING AT LEAST TWICE A DAY.
- FILTER ONLY WHEN "COOL" IS DISPLAYED.
- BRUSH ALL CRACKLINGS FROM COOKPOT SURFACES AND THE COLD ZONE DURING THE FILTERING PROCESS.
- MAKE SURE THE COOKER IS LEVEL.
- BE CERTAIN THE SHORTENING IS NEVER ABOVE THE UPPER COOKPOT "FILL" LINE.
- USE RECOMMENDED PRODUCT LOAD SIZE IN BASKET.

FOR ADDITIONAL INFORMATION ON THESE INSTRUCTIONS REFER TO THE HENNY PENNY SERVICE MANUAL AND THE KFC CONFIDENTIAL OPERATIONS MANUAL ("COM").

**FOR ASSISTANCE CALL THE HENNY PENNY SERVICE DEPARTMENT AT  
1-800-417-8405, or 937-456-8405.**

**SECTION 3. OPERATION**

**3-1. OPERATING CONTROLS**

1	Power/Pump Switch	The Power/Pump Switch is a three way switch with center "OFF" position. Move the switch to the position marked "POWER" to operate the fryer. Move the switch to the position marked "PUMP" to operate the optional portable filter pump. These conditions are covered later in this section.
2	Frypot	This reservoir holds the cooking shortening.
3	Cooking Rack	This stainless steel rack consists of five shelves which contain the food product during and after frying.
4	Lid Gasket	The lid gasket provides the pressure seal for the frypot chamber.
5	Deadweight Valve	The dead weight style operating pressure relief valve is used to maintain a constant level of steam pressure within the frypot. Any excess steam pressure is vented through the exhaust stack.
6	Safety Relief Valve	The safety relief valve is an ASME approved spring loaded valve set at 14.5 psi. In the event the operation valve becomes obstructed, this safety valve will release excess pressure, keeping the frypot chamber at 14.5 psi. If this occurs, turn the Power/Pump switch to the "OFF" position to release all pressure from the frypot.
7	Safety Relief Valve Ring	<p>THE RING IS NOT TO BE PULLED.</p>  <p>Severe burns from the steam will result.</p>
8	Pressure Gauge	The pressure gauge indicates the pressure inside the cookpot.

9	Solenoid Valve	<p>The solenoid valve is an electro-mechanical device that causes pressure to be held in the frypot.</p> <p>The solenoid valve closes at the beginning of the frying cycle and is opened automatically at the end of the frying cycle. If this valve should become dirty or the teflon seat nicked, pressure will not build up and it must be repaired per the maintenance section.</p>
10	Drain Valve	<p>The drain valve is a two-way ball valve. It is normally in the closed position. Pull the knob out to drain the shortening from the frypot into the filter drain pan.</p> <div data-bbox="954 638 1198 821" style="text-align: center;">  <p><b>DANGER</b></p> </div> <p>DO NOT OPEN THE DRAIN VALVE WHILE FRY POT IS UNDER PRESSURE. Hot shortening will exhaust from this valve. Severe burns will result.</p>
11	Drain Interlock	<p>The drain interlock switch is a microswitch that provides Switch protection for the frypot in the event an operator inadvertently drains the shortening from the frypot while the main switch is in the POWER position. The switch is designed to automatically shut off the heat when the drain valve is opened.</p>
12	Condensation	<p>The condensation drain pan is the collection point for the Drain Pan condensation formed within the steam exhaust system. It must be removed and emptied periodically.</p>

**3-2. LID OPERATION**

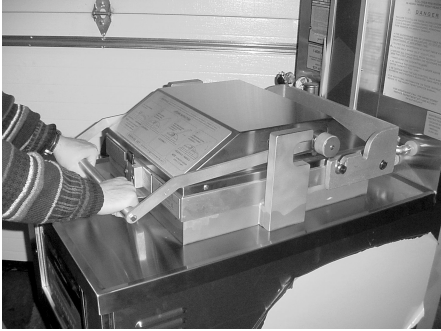

To close lid:

1. Lower the lid until lid latches into place.
2. Pull lid handle forward until it stops.
3. Lift up on the lid handle until it stops.
4. Bring lid handle out towards you until it stops.
5. Push lid handle down, locking lid in place.



DO NOT ATTEMPT TO OPEN LID UNTIL THE PRESSURE DROPS TO ZERO. Lid is locked when fryer is under pressure. Do not attempt to force the lid latch or open the lid while under pressure. Opening the lid when the cookpot is pressurized will allow hot shortening and moisture to escape from the cookpot, resulting in severe burns.

3-2. LID OPERATION (Continued)

To open lid:



1



2



3

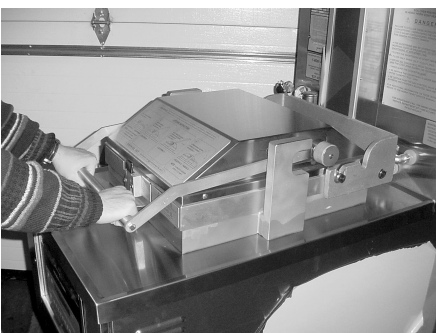

4

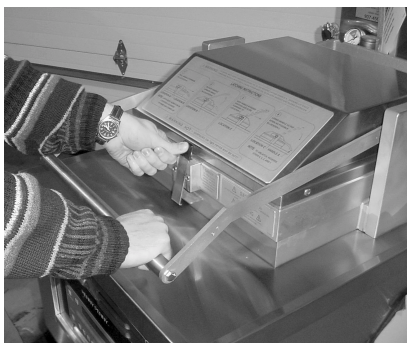

5



DO NOT ATTEMPT TO OPEN LID UNTIL THE PRESSURE DROPS TO ZERO. Lid is locked when fryer is under pressure. Do not attempt to force the lid latch or open the lid while under pressure. Opening the lid when the cookpot is pressurized will allow hot shortening and moisture to escape from the cookpot, resulting in severe burns.

1. Gently raise handle until it stops.
2. Push handle back until it stops.
3. Lower handle.



DO NOT raise the lid with the handle in the up position. Lower the handle before attempting to raise the lid, or damage to the lid could result.

4. Push handle back.
5. Unlatch the front lid latch and raise lid with handle.

**3-3. MELT CYCLE OPERATION**

If the shortening is below 185°F (85°C) with the Power/Pump Switch in the "Power" position, the fryer will enter the melt cycle. The shortening is heated slowly to prevent scorching of the shortening. The display will read "LO" and the heat will cycle, 10 seconds on, 30 seconds off, to ensure slow melting of shortening. No other buttons on the control panel will operate except the Power/Pump Switch.

**NOTE**

Should you require outside assistance, just call 1-800-543-6243, or Ohio, 1-800-762-2964.

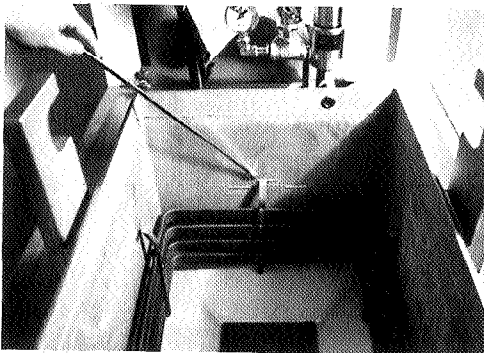
**3-4. FILLING OR ADDING SHORTENING**

1. It is recommended that a high quality frying shortening be used in the pressure fryer. Some low grade shortenings have a high moisture content and will cause foaming and boiling over.
2. If a solid shortening is used, it can be melted into a liquid first, then poured into the cookpot. Attempting to melt solid shortening in the cookpot may cause burning or scorching of the fresh shortening.

**WARNING**

**GLOVES SHOULD BE WORN AND CARE MUST BE TAKEN WHEN POURING HOT SHORTENING.** Severe burns could result. Also, when adding fresh shortening to existing shortening, care must be taken to avoid splashing or severe burns could result.

3. The electric model requires 100 lbs. The pot has three level indicator lines inscribed on the rear wall of the cookpot which show when the heated shortening is at the proper level.
4. Cold shortening should be filled to ½ inch below lower indicator.

### 3-5. FILTERING INSTRUCTIONS

The Henny Penny Electric 8 Head Fryer must be cleaned and the shortening must be cleaned and polished at least twice daily; after lunch rush and at the end of the day.

#### CAUTION

Shortening should be filtered immediately following a cook cycle when the shortening temperature is at or below low heat; less than 270°F. **DO NOT DRAIN THE SHORTENING IF IT IS AT DROP TEMPERATURE.** The high temperature can cause cracklings to burn on the steel cookpot surfaces after the shortening has drained.



Filter only when "COOL" is displayed. Failure to do so can result in shortening overflowing the cookpot, causing serious burns, personal injury, fire and/or property damage.

If volume dictates, cleaning may be required more often. Part of the process involves removing cracklings from the cold zone of the cookpot. High volume cooking could cause the cold zone to fill quicker with cracklings, and if so, cleaning would be required. **SURFACES OF FRYER AND COOK BASKET WILL BE EXTREMELY HOT. USE CARE NOT TO GET BURNED.**

1. Turn power/pump switch OFF before draining shortening.
2. Roll filter unit under fryer and lock in place.



The filter unit must be as far back under fryer as it will go, and latched into place. If not fully seated and latched, the hole in the filter tank cover will not be directly under the drain. This will cause splashing of shortening and could result in severe burns.

Leave filter hose connected to the filter tank and plug the filter power cord into fryer outlet.

3. Remove cooking basket and wipe bottom of lid. Tilt lid out of the way to clean cookpot.

**3-5. FILTERING  
INSTRUCTIONS  
(Continued)**

4. Lift up drain handle safety latch and pull handle out to open drain valve. Use L-shaped brush to clean cracklings from elements (electric fryer only) and from sides and bottom of cookpot as shortening drains. Use straight brush to push cracklings through drain opening in bottom of cookpot if necessary.



Brush ALL cracklings from cookpot surfaces and the cold zone during the filtering process. Failure to do so can result in shortening overflowing the cookpot, which could cause serious burns, personal injury, fire and/or property damage.

5. Turn power/pump switch to PUMP to circulate shortening in filter tank. Polish for 5 (five) minutes.
6. Scrape cracklings and crackling ring from cookpot and discard. DO NOT let cracklings drain into filter tank. These cracklings can cause a burned taste in gravy. Wipe all surfaces with a clean damp towel. If water drops into cold zone, dry with towel before pumping shortening back into cookpot.
7. Turn power/pump switch of OFF, and connect filter hose to cookpot fill line. Lower lid and use swing lock pin to hold lid in lower position to keep shortening from splashing out of cookpot. Turn power/pump switch to PUMP, and close drain valve by pushing handle in all the way.
8. When all shortening has been pumped into cookpot turn power/pump switch OFF.

**3-6. SWITCHES AND INDICATORS**

**NOTE**

If the fryer has the FAST controls, see the FAST operation manual.

**“Lo” Mode**

The display will read “LO” anytime the shortening temperature is below 250°F. When the Power/Pump Switch is placed in the “Power” position, the control will begin a melt mode which cycles the heat on and off. This slowly melts/heats the shortening until the temperature reaches 185°F (85°C). This heat stays on until the “COOL” mode is reached, or until reaching the temperature of the selected cooking cycle.

**“Cool” Mode**

After cooking or filtering the shortening, the temperature will automatically go into the “COOL” mode which keeps shortening at 250°F (121°C). This temperature extends the shortening life and minimizes the time needed to heat the shortening for the next cook cycle. Press “Exit Cool” to leave the “Cool” mode, then press product button for the cook cycle desired.

To manually place the controls in the “COOL” mode, start a cooking cycle, and then press the cycle button again. The display should then show “COOL”. See Cycle Selection below.



Although the display will read “COOL” in the stand-by mode, the shortening is hot and could cause burns.

**Cycle Selection**

Select the cook cycle by pressing the button for the number of heads, or product, to be cooked. Shortening will then heat to “Drop” temperature.

Pressing the same button again will begin the cook cycle. The indicator will change from “Drop” to counting down the cook time in minutes and seconds.

At the end of the cook cycle, press the same button again when the indicator reads “Done” and the alarm sounds. The fryer will reset to the “Cool” mode.

**Time/Temperature Display**

This is a four (4) digit LED type display which shows the remaining cook time during cook cycles and also the shortening temperature on demand from the operator.

**Heater Indicator**

The heat light will illuminate whenever the control calls for heat. When setpoint temperature has been reached the heat light will go off.

**Hi Temperature Indicator**

The display will read “HI” if the shortening temperature is 40° above the setpoint.

<p><b>Drop Indicator</b></p>	<p>The display will read "Drop" when the shortening has reached the setpoint temperature (+4° to -2°).</p>
<p><b>Done Indicator</b></p>	<p>The display will read "Done" at the end of the cook cycle.</p>
<p><b>Temperature Button</b></p>	<p>This button allows the operator to read the temperature of the shortening while in a cook cycle. The display range is from 256°F (124°C) to 390°F (199°C).</p>

**3-7. FRYER POWER MODE**

With the Power Switch in the "Power" position, the mode is selected depending on the temperature of the shortening.

1. If pot temperature is below the melt temperature of 185°F (85°C) the fryer will enter the melt mode. Display will read "LO".
2. If the pot temperature is 185°F (85°C) or higher, the control will regulate the programmed temperature of the selected cycle.
3. The temperature will be regulated at 250°F (121°C), if the "Exit Cool" button is pressed during heat up. The display will read "COOL".



Although the display will read "COOL" in the stand-by mode, the shortening is hot and could cause burns.

**3-8. MODE SELECTION TO FILTER SHORTENING**

When the operator wishes to filter, move the Power Switch to the "OFF" position and filter as usual (refer to filter instructions). The display should read "COOL" before filtering.



To avoid personal injuries or property damage be sure shortening has been pumped back into the cookpot before depressing the "EXIT COOL" switch. Unit will enter heat mode.

### 3-8. MODE SELECTION (Continued)

#### NOTE

The filter pump motor on the PF-180 is equipped with a manual reset button in the event the motor's thermal protection actuates. This reset button is located on the rear of the motor. A hinged door is placed on the motor cover to easily access this reset button. Wait approximately 5 minutes before attempting to reset this protective device. Also, some effort must be used when resetting the button and a definite "click" will be heard when it resets.

#### WARNING

To prevent burns caused by splashing shortening, the unit's main power switch must be in the "OFF" position before resetting the filter pump motor's manual reset protection device.

#### NOTE

The pump motor and the combustion air motor are permanently lubricated and need no maintenance.



Failure of brushing all cracklings from the cookpot and cold zone and putting the controls in the "COOL" mode before filtering can result in shortening overflowing the cookpot. This could cause serious burns, personal injury, fire and/or property damage.

### 3-9. START-UP

The following procedures should be followed on the initial start-up of the fryer each time the fryer is brought from a cold, or shut down condition, back into operation:

1. Make sure the shortening is filled to the proper level in the cookpot - 1/2 inch below lower indicator.



Be certain the shortening is never above the upper cookpot "fill" line. Failure to follow these instructions can result in shortening overflowing the cookpot which could cause serious burns, personal injury, fire and/or property damage.

**3-9. START-UP (Continued)**

2. Turn Power/Pump Switch to the "Power" position, then select the product to be cooked.
3. Stir the shortening as it's heating up from a "cold" start. Be sure to stir down into the cold zone.



Do not stir the shortening at any other time except at initial "cold" start-up. Failure to follow these instructions can result in shortening overflowing the cookpot which could cause serious burns, personal injury, fire and/or property damage.

4. Slide cook basket into rails of lid and push the basket back into the lid as far as it will go.
5. After the product has been loaded onto the basket, the lid can be lowered, immersing the product into the shortening when the display indicates the shortening is at the correct temperature.

**3-10. CLEANING THE FRYPOT**

After the initial installation of the fryer, as well as before every change of shortening, the cookpot should be thoroughly cleaned as follows:

1. Turn the main power switch to "OFF"



The filter drain pan must be in position under the drain valve to prevent splashing or spilling of hot liquids. Failure to do so will result in splashing and severe burns.

2. If hot shortening is present in the cookpot, it must be drained by slowly pulling the drain valve knob.
3. Close the drain valve and discard the shortening.
4. Lower the lid to the lid stop bracket and tilt lid back, so that the lid won't interfere with cleaning.
5. Refer to KFC's COM on cleaning instructions.

### 3-10. CLEANING THE FRYPOT (Continued)



NEVER PRESSURIZE FRYER TO CLEAN. Leave the lid open. Water under pressure is super heated and will cause severe burns if it comes in contact with skin.

#### WARNING

Never heat the cleaning solution to the boiling point. If the cleaning solution in the cookpot starts to foam and boil over, immediately move the main power switch to OFF. DO NOT TRY TO CONTAIN IT BY CLOSING THE FRYER LID, or severe burns could result.

#### CAUTION

Do not use steel wool, other abrasive cleaners or cleaners/sanitizers containing chlorine, bromine, iodine, or ammonia chemicals, as these will deteriorate the stainless steel material and shorten the life of the unit.

#### NOTE

Make sure the inside of the cookpot, the drain valve opening, and all parts that come in contact with the new shortening are dry as possible. Refill the fryer with fresh shortening.

**SECTION 4. TROUBLESHOOTING****4-1. INTRODUCTION**

This section provides troubleshooting information in the form of an easy to read table.

If a problem occurs during the first operation of a new fryer, recheck the installation per the Installation Section of this manual.

Before troubleshooting, always recheck the operation procedures per Section 3 of this manual.

**4-2. TROUBLESHOOTING**

To isolate a malfunction, proceed as follows:

1. Clearly define the problem (or symptom) and when it occurs.
2. Locate the problem in the Troubleshooting table.
3. Review all possible causes. Then, one-at-a-time work through the list of corrections until the problem is solved.
4. Refer to the maintenance procedures in the Maintenance Section to safely and properly make the checkout and repair needed.

**WARNING**

If maintenance procedures are not followed correctly, injuries and/or property damage could result.



Problem	Cause	Correction
---------	-------	------------

**COOKING SECTION (Continued)**

<p>D. Spotted Product</p>	<ul style="list-style-type: none"> <li>• Improper separation of the product.</li> <li>• Breading not uniform on the product.</li> <li>• Burned breading particles on product.</li> <li>• Product sticking together.</li> </ul>	<ul style="list-style-type: none"> <li>• Load product into racks properly.</li> <li>• Sift breading regularly.</li> <li>• Separate product during breading.</li> <li>• Filter the shortening more frequently.</li> <li>• Separate product prior to pressure cooking.</li> </ul>
<p>E. Dryness of Product</p>	<ul style="list-style-type: none"> <li>• Moisture loss prior to cooking.</li> <li>• Overcooking the product.</li> <li>• Low operating pressure.</li> </ul>	<ul style="list-style-type: none"> <li>• Use fresh products.</li> <li>• Reduce cooking time.</li> <li>• Reduce cooking temperature.</li> <li>• Check pressure gauge reading, check for pressure leaks.</li> </ul>
<p>Product Flavor (Taste):</p>	<ul style="list-style-type: none"> <li>• Wrong cook button pushed.</li> </ul>	<ul style="list-style-type: none"> <li>• Be sure to select the correct amount of product to be cooked.</li> </ul>
<p>A. Salty Taste</p>	<ul style="list-style-type: none"> <li>• Breading mixture is too salty.</li> <li>• Incorrect choice of breading.</li> </ul>	<ul style="list-style-type: none"> <li>• Sift breading after each use.</li> <li>• Incorrect breading mixture.</li> <li>• Discard old breading.</li> <li>• Use breading designed for the desired product.</li> </ul>
<p>B. Burned Taste</p>	<ul style="list-style-type: none"> <li>• Burned shortening flavor.</li> <li>• Cookpot not properly cleaned.</li> </ul>	<ul style="list-style-type: none"> <li>• Replace shortening.</li> <li>• Drain and clean cookpot.</li> </ul>
<p>C. Bland Taste</p>	<ul style="list-style-type: none"> <li>• Raw product not fresh.</li> <li>• Breading mixture incorrect for product (spice content too low).</li> <li>• Cooking temperature too high (spice flavors lost).</li> </ul>	<ul style="list-style-type: none"> <li>• Use fresh raw products.</li> <li>• Use breading designed for desired product.</li> <li>• Check temperature.</li> </ul>

Problem	Cause	Correction
<b>COOKING SECTION (Continued)</b>		
<p>D. Rancid Taste</p> <p>General:</p> <p>A. Meat Separation From Bone</p> <p>B. Bone Color Not Proper</p> <p>C. Breading Falls Off</p> <p>D. Product Sticking Together</p>	<ul style="list-style-type: none"> <li>• Shortening too old.</li> <li>• Non compatible products cooked within the same shortening.</li> <li>• Infrequent filtering.</li> <li>• Raw product not fresh.</li> <li>• Incorrect meat cut.</li> <li>• Overcooking.</li> <li>• Product not fresh.</li> <li>• Using frozen product (black bone).</li> <li>• Improper processing of product (black bone).</li> <li>• Product not thoroughly cooked (red bone).</li> <li>• Incorrect breading procedures.</li> <li>• Product partially frozen.</li> <li>• Product breaded too long prior to cooking.</li> <li>• Improper loading procedure.</li> <li>• Wrong cook button pushed.</li> </ul>	<ul style="list-style-type: none"> <li>• Replace shortening, and follow recommended care and use of shortening.</li> <li>• Replace shortening.</li> <li>• Use compatible products, and follow recommended care and use of shortening.</li> <li>• Replace shortening, and follow recommended care and use of shortening.</li> <li>• Use fresh product.</li> <li>• Use correct meat cutting procedures.</li> <li>• Check cooking time.</li> <li>• Use fresh product.</li> <li>• Use fresh product.</li> <li>• Use proper processing procedure for product.</li> <li>• Check cooking time.</li> <li>• Check cooking temperature.</li> <li>• Use correct breading procedure.</li> <li>• Thoroughly thaw the product, before breading.</li> <li>• Refer to breading and frying instructions.</li> <li>• Properly load product per loading procedures.</li> <li>• Be sure to select the correct amount of product to be cooked.</li> </ul>



Problem	Cause	Correction
<b>LID/PRESSURE SECTION (Continued)</b>		
 <p>DO NOT OPERATE UNIT IF HIGH PRESSURE CONDITIONS EXIST. SEVERE INJURIES AND BURNS WILL RESULT. Place the Power/Pump switch in the "OFF" position immediately. Release the pressure by allowing unit to cool. The pressure will then drop. Do not resume use of unit until cause of high pressure has been found and corrected.</p> <p>Pressure does not build</p>	<ul style="list-style-type: none"> <li>• Exhaust line to stack clogged.</li> <li>• Not enough product in fryer or product not fresh.</li> <li>• Metal shipping spacer not removed from dead weight.</li> <li>• Lid open or not latched.</li> <li>• Solenoid valve leaking or not closing.</li> <li>• Dead weight valve leaking.</li> <li>• Pressure not programmed.</li> <li>• Lid gasket leaking.</li> </ul>	<ul style="list-style-type: none"> <li>• Clean exhaust line to stack.</li> <li>• Place proper quantity of fresh product within cookpot to generate steam.</li> <li>• Remove shipping spacer. See Unpacking Section.</li> <li>• Close and latch lid.</li> <li>• Check or clean solenoid valve per Maintenance Section on the Solenoid Valve.</li> <li>• Repair per Maintenance Section on Operating Valve.</li> <li>• Check programming.</li> <li>• Shims need to be added to lid assembly. See Maintenance Section under lid system.</li> </ul>

Problem	Cause	Correction
<b>PRESSURE SECTION (Continued)</b>		
Lid won't move up or down	<ul style="list-style-type: none"> <li>• Safety relief valve leaking.</li> <li>• Pressure pad broken or crushed.</li> </ul>	<ul style="list-style-type: none"> <li>• Check and replace if necessary per maintenance section on the relief valve.</li> <li>• Replace pressure pads.</li> </ul>
	<ul style="list-style-type: none"> <li>• Cable on Counterweight loose or broken</li> <li>• Check operation of counterweight carriage in rear of cooker.</li> </ul>	<ul style="list-style-type: none"> <li>• Put cable on Counterweight per section on Counterweight Cable.</li> <li>• Make proper adjustments.</li> </ul>

Problem	Cause	Correction
---------	-------	------------

**HEATING OF SHORTENING SECTION**

<p>Shortening will not heat (Electric Model)</p>	<ul style="list-style-type: none"> <li>• Blown fuse or tripped circuit breaker at supply box or control panel.</li> <li>• Blown fuse at control panel.</li> <li>• Faulty cord and plug.</li> <li>• Faulty contactor.</li> <li>• Faulty Power/Pump switch.</li> <li>• Faulty drain switch.</li> <li>• Faulty PC Board.</li> <li>• Faulty high limit control switch.</li> <li>• Low or improper voltage.</li> <li>• Weak or burnt out element(s).</li> <li>• Points in contactor bad.</li> <li>• Wire(s) loose.</li> <li>• Burnt or charred wire connection.</li> </ul>	<ul style="list-style-type: none"> <li>• Reset breaker or replace fuse.</li> <li>• Check fuse per Maintenance Section on Fuses.</li> <li>• Check cord and plug and power at wall receptacle.</li> <li>• Check contactor per Maintenance Section on Contactors.</li> <li>• Check Power/Pump switch per Maintenance Section on Power/Pump switch.</li> <li>• Check drain switch per Maintenance Section on Drain Switches.</li> <li>• Remove and replace control panel.</li> <li>• Check high limit control switch per Maintenance Section on High Limit.</li> <li>• Use a meter and check the receptacle against data plate.</li> <li>• Check heating element(s) per Maintenance Section on Heating Elements.</li> <li>• Check contactor per Maintenance Section on Contactors.</li> <li>• Tighten.</li> <li>• Replace wire and clean connectors.</li> </ul>
<p>Heating of shortening too slow (Electric Model)</p>		

Problem	Cause	Correction
---------	-------	------------

**HEATING OF SHORTENING SECTION (Continued)**

<p>Shortening overheating (Electric Model)</p>	<ul style="list-style-type: none"> <li>• Check shortening temperature.</li> <li>• Check contactor for not opening.</li> <li>• Faulty PC Board.</li> <li>• Faulty probe.</li> </ul>	<ul style="list-style-type: none"> <li>• Check temperature setting in the program mode.</li> <li>• Check faulty contactor per Maintenance Section on Contactors.</li> <li>• Remove and replace control panel.</li> <li>• Remove and replace probe.</li> </ul>
--	--	---

**SHORTENING FOAMING/DRAINING SECTION**

<p>Foaming or boiling over of shortening</p>	<ul style="list-style-type: none"> <li>• Water in shortening.</li> <li>• Condensation line stopped up.</li> <li>• Improper or bad shortening.</li> <li>• Cold zone full of cracklings.</li> <li>• Improper rinsing after cleaning the fryer.</li> </ul>	<ul style="list-style-type: none"> <li>• At end of cooking cycle, drain shortening and clean cookpot. Add fresh shortening.</li> <li>• Remove and clean condensation line.</li> <li>• Refer to the procedure covering filtering the shortening.</li> <li>• Filter shortening.</li> <li>• Clean and neutralize the cookpot. Rinse with vinegar to remove the alkaline, then rinse with hot water and dry cookpot.</li> </ul>
<p>Shortening will not drain from cookpot</p>	<ul style="list-style-type: none"> <li>• Drain valve clogged with crumbs.</li> <li>• Drain valve will not open by pulling the knob.</li> </ul>	<ul style="list-style-type: none"> <li>• Open valve - push cleaning brush through drain opening from inside of cookpot.</li> <li>• Replace cotter pins in valve coupling.</li> </ul>
<p>Shortening leaking through drain valve.</p>	<ul style="list-style-type: none"> <li>• Obstruction in drain.</li> <li>• Faulty drain valve.</li> </ul>	<ul style="list-style-type: none"> <li>• Remove obstruction.</li> <li>• Replace drain valve.</li> </ul>



## SECTION 5. MAINTENANCE

## 5-1. INTRODUCTION

This section provides procedures for the checkout and replacement of the various parts used within the fryer. Before replacing any parts, refer to the Troubleshooting section. It will aid you in determining the cause of the malfunction.

## 5-2. ARRANGEMENT

This section is arranged in groupings of the components that work together within the fryer. The general groups are listed below.

- Removing the Control Panel
- Probe
- Electrical Components
- Control Board
- Pressure System

## 5-3. MAINTENANCE HINTS

1. You may want to use a multimeter to check the electric components.
2. When the manual refers to the circuit being closed, the multimeter should read zero unless otherwise noted.
3. When the manual refers to the circuit being open, the multimeter will read infinity.
4. The weights can be removed from the frame to easily access the rear of cooker.

## 5-4. ELECTRICAL COMPONENTS

The following electrical components are described in this section.

1. High Limit
2. Fuse Holders
3. Power/Pump Switch
4. Contactors
5. Heating Elements
6. Temperature Probe
7. Complete Control Panel Henny Penny

## 5-5. HIGH TEMPERATURE LIMIT CONTROL (Electric Models)

### Description



This high temperature control is a manual reset control which senses the temperature of the shortening. If the shortening temperature exceeds 420° F (215° C), this control switch will open and shut off the heat to the cookpot. When the temperature of the shortening drops to a safe operation limit, the control must be manually reset. The reset button is located above the filter knob in the front of the cooker. This will allow heat to be supplied to the cookpot.

### Checkout

Before replacing a high temperature limit control, check to see that its circuit is closed.

#### NOTE

The shortening temperature must be below 380° F (193° C) to accurately perform this check.

1. Remove electrical power supplied to the fryer.

#### WARNING

Remove electrical power supplied to the fryer by unplugging the unit, or by turning off the wall circuit breaker or electrical shock could result.

2. Remove the control panel.
3. Remove the two electrical wires from the high temperature limit control.
4. Manually reset the control, then check for continuity between the two terminals after resetting the control. If the circuit is open, replace the control, then continue with this procedure. (If the circuit is closed, the high limit is not defective. Reconnect the two electrical wires.)

## 5-5. HIGH LIMIT (Continued)

## Replacement

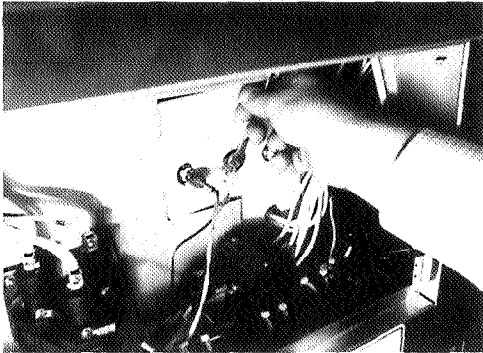

4

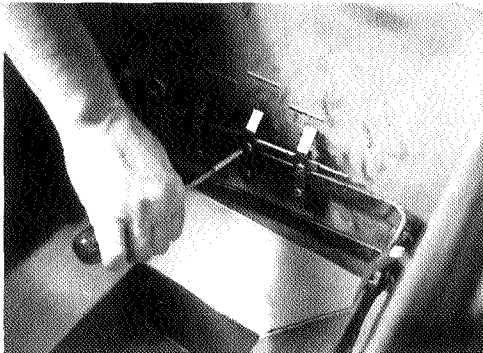

5

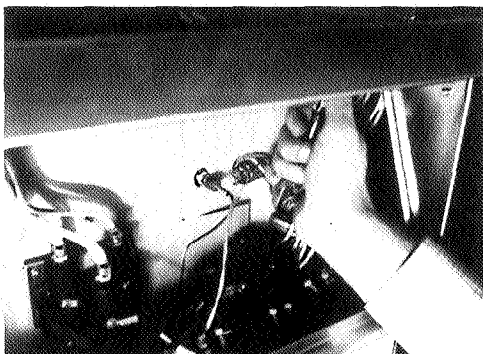

7

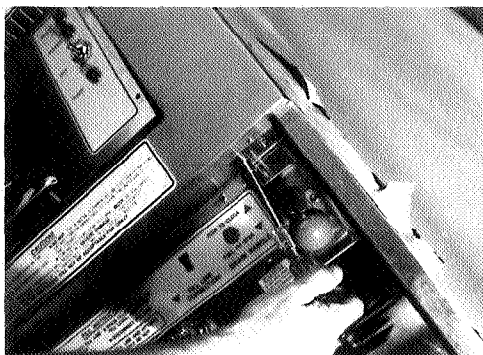

8

**WARNING**

Remove electrical power supplied to the fryer by unplugging the unit, or by turning off the wall circuit breaker or electrical shock could result.

1. If the tube is broken or cracked, the control will open, shutting off electrical power. The control cannot be reset.
2. Drain shortening from the cookpot and discard. A substance in the tube could contaminate the shortening.
3. Remove control panel.
4. Loosen small inside screw nut on capillary tube.
5. Remove capillary bulb from bulb holder inside the cookpot.
6. Straighten the capillary tube.
7. Remove larger outside nut that threads into pot wall.
8. Remove the two nuts securing the high limit bracket at the front of the fryer, and remove bracket.
9. Remove the two screws that secure high limit to the high limit bracket.
10. Remove defective control from control panel area.
11. Insert new control and replace screws.
12. Uncoil capillary line, starting at capillary tube, and insert through cookpot wall.

**WARNING**

To avoid electrical shock or other injury, the capillary line must run under and away from all electrical power wires and terminals. The tube must NEVER be in such a position where it could accidentally touch the electrical power terminals.

13. Carefully bend the capillary bulb holder on heating elements.
14. Slip capillary bulb into bulb holder located on heating elements. Pull excess capillary line from pot and tighten nut into cookpot wall.

5-5. HIGH LIMIT (Continued)

**CAUTION**

Be sure capillary bulb of high limit is positioned as not to interfere with carrier or when cleaning the cookpot wall, or damage to capillary tube could result.

15. With excess capillary line pulled out, tighten smaller nut.
16. Replace front panel.
17. Refill with shortening.

5-6. FUSE HOLDERS

There are two fuse holders on each model of the electric fryers. There are no fuse holder assemblies for the gas models other than that at the main power source.



**WARNING**

Remove electrical power supplied to the fryer by unplugging the unit, or turning off the wall circuit breaker or electrical shock could result.

Checking Procedure for Fuses

CONTROL PANEL FUSES 3 Phase Check from #54 to #55 and #68 to #69 on fuse assembly, or the fuse can be removed to check for a closed circuit. If not, replace the fuse (HP# EF02-007).

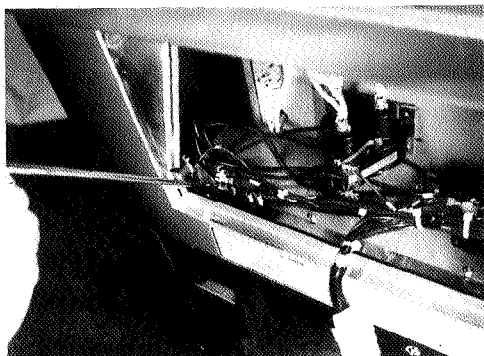

5-7. POWER/PUMP SWITCH

The Power/Pump Switch is a three way rocker switch with a center "OFF" position. With the switch in the POWER position the fryer will operate. With the switch in the PUMP position the filter pump will operate, but the heating unit will not.

Checkout

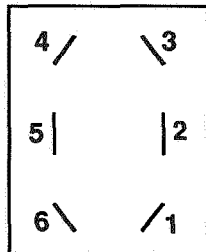

1. Remove Control Panel.



Remove electrical power supplied to the fryer by unplugging the unit, or turning off the wall circuit breaker or electrical shock could result.

2. "OFF" Position - should be open circuit anywhere on the switch.
3. "Power" Position  
Check from:  
-5 to -6 closed circuit  
-1 to -2 closed circuit
4. "Pump" Position  
Check from:  
#4 to #5 closed circuit  
#3 to #2 closed circuit

NOTE

Check across the jumpers on the wires of the Power/Pump Switch. These jumpers have resistors and capacitors which may be faulty.

Replacement

1. With control panel removed and wires off of the switch, push in on tabs on the switch to remove from the panel.
2. Replace with new switch, and reconnect wires to switch following the wiring diagram.
3. Replace the control panel.

5-8. CONTACTORS

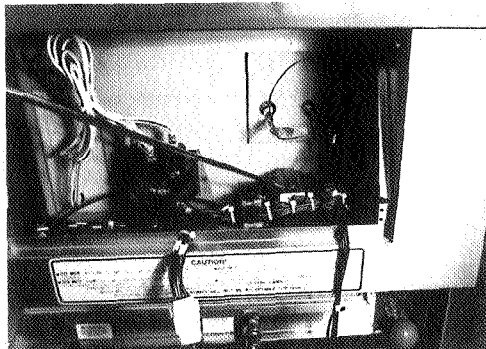

Primary

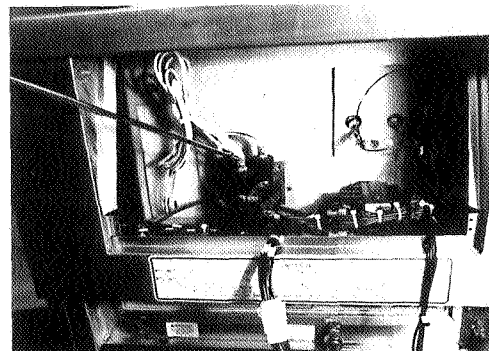

Heat

Checkout

The electric fryer requires two switching contactors: a primary contactor and a heat contactor. The primary contactor energizes (contacts close) any time the Power/Pump Switch is in the "Power" position and the temperature of the pot is below 420° F (215° C). The hi limit will cut the power at the primary contactor if temperatures in the cookpot exceed 420° F (215° C). The primary contactor supplies power to one side of the heat contactors.

The heat contactor is controlled by the computer controller. When the controller calls for heat, the heat contactor applies power to one side of the heating elements. When the heat contactor and the primary contactor are energized (contacts closed), the electric heating elements heat the shortening.

1. Remove electrical power supplied to the fryer.

**WARNING**

Remove electrical power supplied to the fryer by unplugging the unit, or turning off the wall circuit breaker or electrical shock could result.

2. Remove the control panel.
3. Perform a check on both contactors as follows:

Test Point	Results
L3 - L3	Open Circuit
L2 - L2	Open Circuit
L1 - L1	Open Circuit

4. Check across the coil terminals:  
 Standard Contactor - 415 ohms  
 Mercury Contactor - 1500 ohms

## 5-8. CONTACTORS (Continued)

### WARNING

The following checks are performed with the wall circuit breaker on, and the Power/Pump Switch in the "Power" position. Extreme caution should be taken. Make connections before applying power, take reading, and remove power by unplugging the power cord, or by turning off the wall circuit breaker, before removing meter leads or electrical shock could result.

5. With power re-applied and in a heat-up mode, check the power going to both contactor coils. This is to be sure power is going to the contactors.

If no voltage is found going into the coils, check wiring, hi-limit, and drain switch for the primary contactor. (See Maintenance Section.) For the heat contactor, check wiring and connection at the P.C. Board.

## Replacement

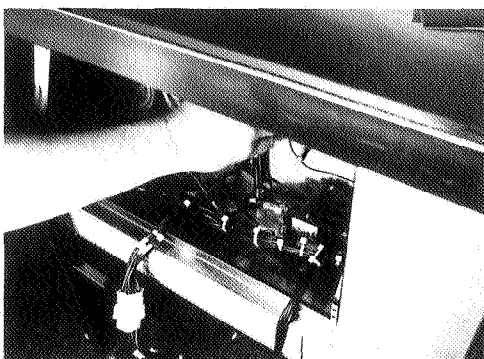
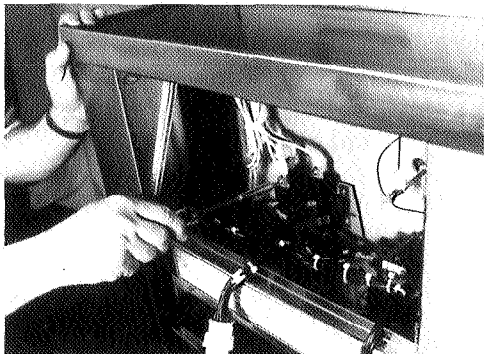

If either contactor is defective it must be replaced as follows:

### WARNING

Remove electrical power supplied to the fryer by unplugging power cord or turning off the wall circuit breaker, or electrical shock could result.

1. Remove only those wires directly connected to the contactor being replaced. Label the wires.
2. Remove the two mounting screws on the base plate and remove standard contactor (primary). Proceed to step 5.
3. Remove the two nuts securing the mercury contactor bracket to the base plate and remove bracket.
4. Remove the two screws securing the mercury contactor to the bracket and remove contactor.
5. Install new contactor in reverse order of previous steps.
6. Install control panel.
7. Reconnect power to fryer and test the fryer for proper operation.

5-9. HEATING ELEMENTS

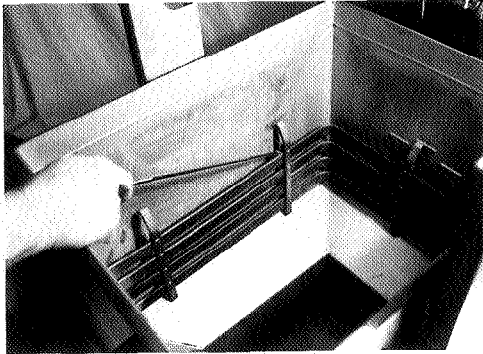

Each electric fryer uses two heating elements.

**NOTE**

Heating elements are available for 208 or 220/240, 380 and 415 voltage. Check the data plate on the right side panel of unit to determine the correct voltage.

If the shortening's temperature recovery is very slow, or at a slower rate than required, this may indicate defective heating element(s). A multimeter will quickly indicate if the elements are shorted or open.

1. Remove electrical power supplied to the fryer.

**WARNING**

Remove electrical power supplied to the fryer by unplugging the unit, or turning off the wall circuit breaker or electrical shock could result.

2. Remove the Control Panel.

**WARNING**

The following checks are performed with the wall circuit breaker closed and the Power/Pump switch in "Power" position. Extreme caution should be taken. Make connections before applying power, take reading, and remove power by unplugging the power cord, or by turning off the wall circuit breaker, before removing meter leads, or electrical shock could result.

3. Perform an amp check on one heating element at a time with the wires connected to the contactors. The two heaters actually have three small heating elements on the inside of the outer plate. It is important to check between the correct wires to obtain an accurate amp reading. The wires are labelled for your convenience.

Wires	Power	Voltage	Amperage
L1 - L3	8500 W	208 V	47.8
L3 - L2	8500 W	208 V	47.9
L2 - L1	8500 W	208 V	48.0
L1 - L2	8500 W	240 V	39.4
L3 - L2	8500 W	240 V	40.1
L2 - L1	8500 W	240 V	39.9

## Replacement

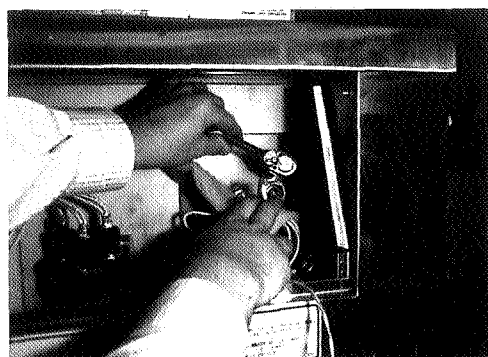
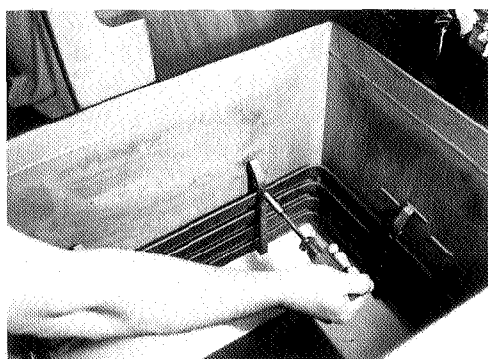

1. Drain the shortening.
2. Remove the high limit bulb holder from the heating element.
3. Remove the Control Panel.
4. Disconnect the heating element wires from the contactors.
5. Loosen the screws on the element spreaders.
6. Slide the element spreaders to the back of the heating elements.
7. Remove the brass nuts and washers which secure the ends of the elements through the cookpot.
8. Remove the heating elements from the cookpot as a group by lifting the far end and sliding them up and out toward the rear of the cookpot.

**CAUTION**

Always install new rubber "O" rings when installing heater elements, or shortening may leak inside cooker.

9. Install new heating elements with new rubber "O" rings mounted in the center of the stacked elements.
10. Replace the heating elements, terminal ends first at approximately 45° angle, slipping the terminal ends through the front wall of the cookpot.
11. Replace the brass nuts and washers on the heating element terminals.
12. Move the element spreaders from the back of the elements into a position which will spread each element apart evenly on all four sides, and tighten.
13. Replace the high limit bulb holder on the top element, and position on the bulb above the top element and tighten screws which hold bulb in place.
14. Reconnect the wires to the appropriate terminals.
15. Replace the front control panel.
16. Connect the power cord to the wall receptacle or turn wall circuit breaker on.

**CAUTION**

Heating elements should never be energized without shortening in the cookpot, or damage to heating elements could result.

### 5-10. DRAIN SWITCH

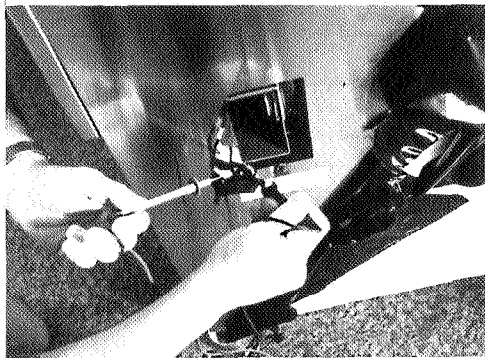
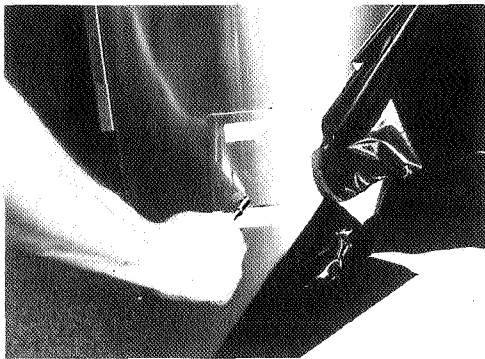

All fryers are equipped with a drain valve micro-switch that prevents heat from coming on when the drain valve is open. With the drain valve open, the switch prevents power from being applied to the coil of the primary and heat contactors, and the solenoid coil.

#### WARNING

Remove electrical power supplied to the fryer by unplugging the unit, or turning off the wall circuit breaker or electrical shock could result.

1. The following check should be made to determine if the Drain Switch is defective.
  - a.) Remove the access panel on the right side of the unit.
  - b.) Remove switch from unit, using 9/16" wrench.
  - c.) Check for continuity across the two outside terminals on the Drain Switch. If circuit is open, the Drain Switch is bad. The circuit should only be opened by pressing on the actuator of the Drain Switch.
2. To replace the Drain Switch, remove the wires from switch.
3. Connect wires to new Drain Switch, and reposition switch in unit.
4. Test to see if drain valve extension rod actuates the switch. NOTE - Listen for CLICK of switch while pulling drain valve extension rod.

### 5-11. TEMPERATURE PROBE REPLACEMENT



The Temperature Probe relays the actual shortening temperature to the control. If it becomes disabled, PROB will show in the display. Also, if the temperature is out of calibration more than 10° F or C°, the probe should be replaced as follows:

1. Remove electrical power supplied to the fryer.

#### WARNING

Place the Power Switch to the "OFF" position, and unplug the power cord or turn the wall circuit breaker off or electrical shock could result.

2. Drain the shortening from the cookpot.

## 5-11. TEMPERATURE PROBE REPLACEMENT (Continued)

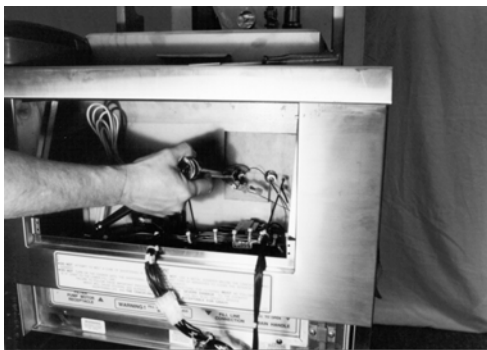

3. Remove the Control Board.
4. Remove probe connections from PC board.
5. Using a 1/2" wrench, remove the nut on the compression fitting.
6. Remove the probe from the cookpot.
7. Place the nut and new ferrule on the new probe and insert the probe into the compression fitting until it extends .475 inches (12 mm) into the cookpot.
8. Tighten hand-tight and then a half a turn with wrench.

**CAUTION**

Excess force damages the probe.

9. Connect new probe to PC board and replace Control Panel.
10. Replace shortening.
11. Turn power "ON" and check out fryer.

### 5-12. COMPLETE CONTROL PANEL HENNY PENNY



Should the Control Panel become inoperative, follow these instructions for replacing the board.

1. Remove electrical power supplied to the fryer.

Place the Power/Pump Switch in the "OFF" position,

**WARNING**

and unplug the power cord and/ or turn the wall circuit breaker off or electrical shock could result.

2. Remove the two screws securing the Control Panel and lift panel up and out.
3. Unplug the connectors going to the Control Board.
4. Install a new Control Panel.

**CAUTION**

When plugging connectors into new Control Panel be sure connectors are put on in the correct manner, such as, be sure connector isn't put on backwards.

### 5-13. PRESSURE REGULATION

The Henny Penny Fryer uses pressure as one of the components of the cooking process. Once the lid is sealed to the cookpot, and the solenoid valve closes, a deadweight valve maintains the correct pressure in the cookpot.

The lid has minimal and limited maintenance and repair procedures, which are addressed in the following sections.

**5-14. PREVENTIVE MAINTENANCE**

The following is a routine maintenance schedule for the Lid:

**Every 90 days**

- Clean and reverse lid gasket

**Yearly Cleaning and Inspection**

- Remove and clean Safety Relief Valve
- Check Lid Gasket for splitting and tears - replace if necessary
- Check Pressure Pads for wear - rotate if necessary
- Check Cam Slide Guides - replace if worn or broken
- Check Lid Rollers - replace if cracked or damaged.

**5-15. REVERSING LID GASKET**

The gray rubber gasket surrounding the inside of the lid is designed to be reversed. HENNY PENNY RECOMMENDS THIS BE DONE EVERY 90 DAYS.

Because heat expansion and the pressure used for the cooking process, the gasket is constantly under extreme stress. Reversing the lid gasket every 90 days helps to assure the fryer won't lose pressure through leakage.



“kickstand”

1. Open the lid completely, tilt lid back, and lock lid in place with the “kickstand”.
2. Using a thin blade screwdriver pry out the gasket at the corners. Remove the gasket.

### 5-15. REVERSING LID GASKET (Continued)

#### NOTE

Check the gasket for any tears or nicks. If the gasket is damaged it needs to be replaced.

#### WARNING

Be careful that the lid doesn't fall down while it is in the upright position, or serious injury could result.

3. Clean the gasket and gasket seat with hot water.
4. Rotate the gasket with the opposite side facing out.

#### NOTE

Begin the installation by installing the four corners of the lid gasket, and smoothing the gasket into place from the corners.

### 5-16. LID COUNTERWEIGHT

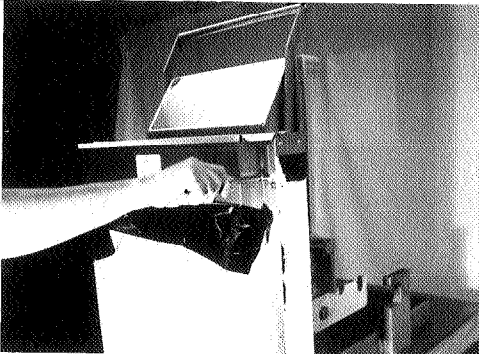

The Lid Counterweight in the back of the fryer balances the weight of the lid system to allow easier opening and closing of the lid. The weight has two cables attached to it, and weighs about 150 lbs. (67.5 Kg). One cable is centered on the weight and is the cable being used. The other cable is a safety cable and is off center. In case the main cable becomes loose or broken, the safety cable catches the weight and puts the weight into a bind, not allowing the lid to be opened or closed.

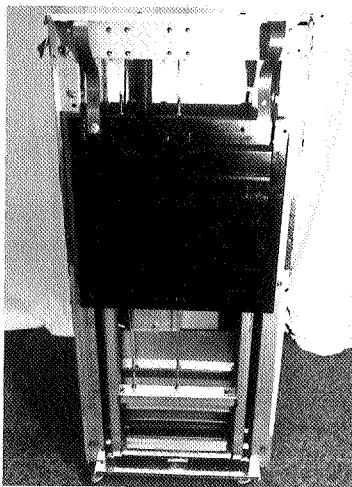

#### Replacement/Repair

1. Using a 3/8" socket, remove the back shroud of the fryer.
2. With one person holding the weight level, another person locks the lid down.
3. Unthread the broken cable from the weight and the bracket attached to the fryer, and remove broken cable.
4. Thread a 5/16" nut on each end of the new cable.
5. Screw the new cable into the weight, using a wrench, until it is tight.

**Replacement/Repair  
(Continued)**

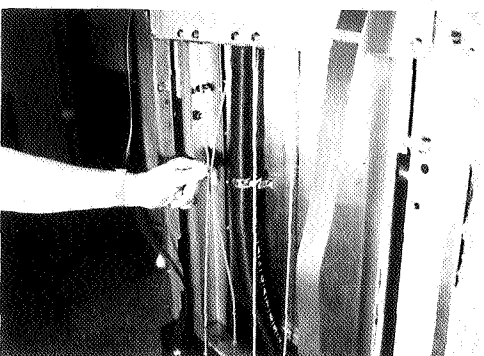
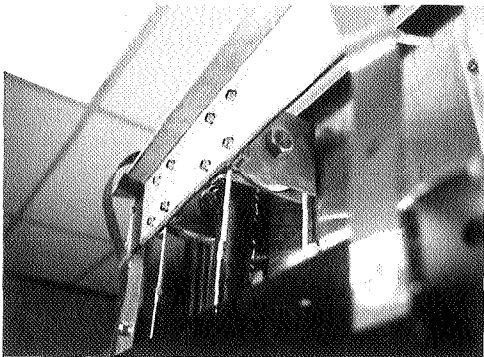
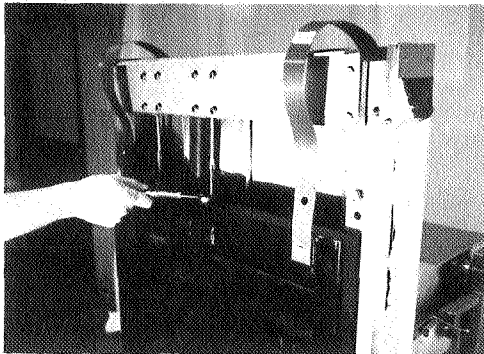

6. Using a 1/2" wrench, tighten the nut (already threaded on the cable) against the weight securing the cable into the weight.
7. Pull cable over pulley and down behind the weight.
8. Thread the other end of the cable through a 5/16" nut on the underside of the bracket.
9. Tighten the cable up by screwing the cable through the nut, until the weight becomes level.

**NOTE**

The safety cable should now have some slack in it, with the weight level.

10. Tighten the nut against the bracket, securing the cable.
11. Replace the back shroud. Repair is now complete.

## 5-17. PRESSURE PAD

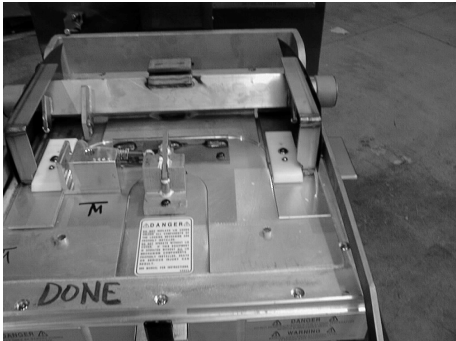

The pressure pads are plastic strips that the lid cam presses against to seal the lid.

1. Raise the lid.
2. Remove the four screws securing the lid cover and remove cover.
3. Push the lid cam back, off of the pressure pads.
4. Using an Allen wrench, remove large bolt securing the pad.
5. Using a Phillips head screw driver, remove the small screw securing the pad and remove the broken pad.

**NOTE**

If the pressure pad is worn, but not broken, it can be reversed 180 degrees, and the other end of the pad used.

6. Install new pad in reverse order.

**5-18. LID ADJUSTMENT**

If steam leaks out from around the lid gasket, the pressure pads could be worn or broken. If the pressure pad is worn, but not broken, it can be reversed 180 degrees, and the other end of the pad used. See Section 5-17.

**WARNING**

Other problems could cause the steam to leak, such as a cracked or worn gasket, or gasket not installed properly. Be certain leaking is not caused by too much pressure before making any lid adjustments. Fryer should be operating at 12 psi. Refer to Operating Control Valve section. All these areas should be checked, or serious burns could result.

**5-19. ADJUSTING THE MAGNET PLATE**

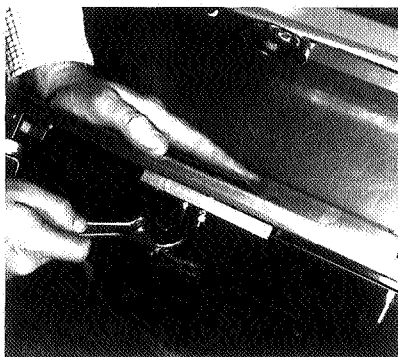

With the carrier and racks installed on the lid, the lid should stay down, in contact with the pot rim, when the lid is lowered. The user will then be able to lock the lid in place. If the lid has a tendency to rise up before getting the lid locked down, the magnet plate probably needs adjusting. Follow these steps:

1. Remove the six nuts securing the back shroud and remove back shroud.
2. Loosen the bottom nut under the plate and unscrew both nuts a couple turns, then lower the lid again to see if the lid stays down. If not, repeat procedure.
3. Tighten lower nut up against the other nut and install back shroud - adjustment is now complete.

**5-20. SOLENOID VALVE**

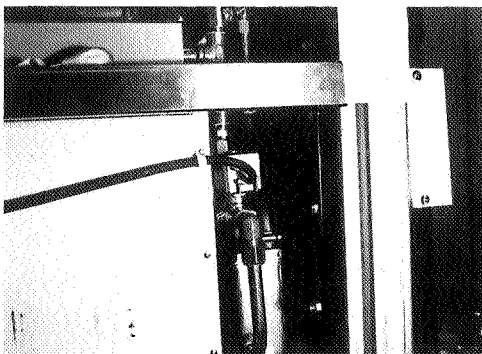

This is an electromechanical device that causes pressure to be held in the cookpot. The solenoid valve closes at the beginning of the cook cycle and opens automatically at the end of the cook cycle. If this valve should become dirty, or the Teflon seat nicked, pressure will not build up. The electric fryer uses a 208/240 volt, 60 hertz coil (50 hertz internationally).

**WARNING**

Before starting repair procedures, move the Power/Pump Switch to the "OFF" position. Disconnect main circuit breaker at the circuit breaker box and/or unplug service cord from the wall receptacle or electrical shock could result.

**Coil Check Procedure**

Remove the solenoid wires from the wire nuts which are found behind the control panel. Check across wires.

	<b>RESULTS</b>
208/240 Volt, 60 Hertz	150 Ohms
208/240 Volt, 50 Hertz	230 Ohms

## Replacement

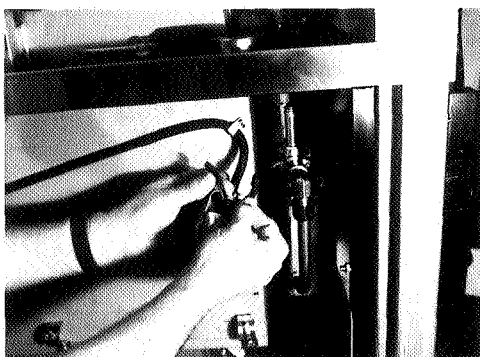
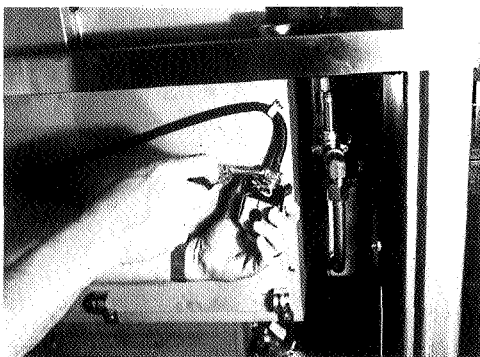
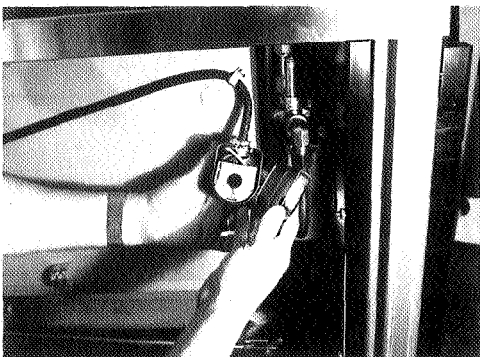
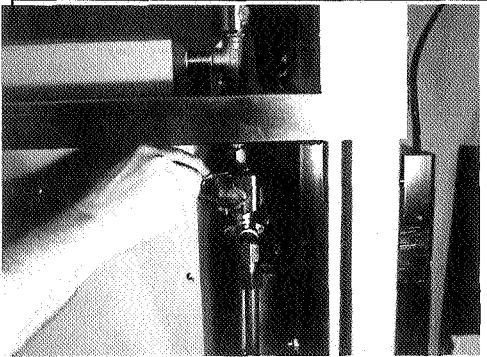

## NOTE

Prior to servicing the solenoid valve, it is necessary to remove the side panel on the right side of the unit.

1. Remove the "tru-arc" retaining clip on top of the coil housing.
2. Remove the cover.
3. If only the coil is to be replaced, disconnect the two coil wires at the wire nuts in the coil housing. Remove the coil, insert new coil, and connect the wires at the wire nuts. Assemble in reverse order of disassembly.

## NOTE

The wires may be connected in any order.

4. Loosen the screws on the strain relief and pull the wires through the relief.
5. If the core-disc assembly is sticking due to build-up of shortening, breading, and food particles, proceed with the following steps:
  - a. Unscrew the solenoid bonnet assembly from the solenoid valve body.
  - b. Remove the solenoid bonnet assembly and bonnet gasket.
  - c. Remove the core-disc assembly, core spring retainer, and the core spring.
  - d. Wash all these parts in hot water.

## NOTE

If Teflon seals need to be replaced, proceed to Step 6; otherwise, assemble in reverse order of disassembly. Assemble valve core and blade with smooth side and rounded edge of blade toward the disc spring guide.

6. A repair kit (Part No. 17120) is available if any of the seals must be replaced. If any one seal is defective, they all should be replaced.

## NOTE

Solenoid body must be removed from the fryer for replacement of seals.

### 5-20. SOLENOID VALVE Replacement (Continued)



7. With the bonnet assembly and core-disc assembly removed, disconnect the two nut fittings. One connects the solenoid valve to the dead weight system; the other is attached to the condensation tank.
8. Remove the elbows from the solenoid valve.
9. Remove the two adapter screws which attach the pipe adapter to the solenoid valve body.
10. Remove the disc spring, guide, and Teflon seat.
11. Clean the valve body.
12. Wet "O" ring around seat with water and insert "O" ring assembly (flat side first) in valve through "IN" side of body. Use an eraser end of pencil and press in the Teflon seal until it snaps into place. **BE CAREFUL NOT TO MAR OR NICK THE SEAT.**

#### NOTE

The smallest nick can cause a pressure leak. Replace all "O" ring seals that are in the parts kit and reassemble valve.

13. If the complete valve is being replaced, follow steps 1, 2, 3, 4, 5, 7, and 8, in this section.

### 5-21. OPERATING CONTROL VALVE



**DO NOT ATTEMPT TO REMOVE THE VALVE CAP WHILE THE FRYER IS OPERATING, or severe burns or other injuries could result.**

The operating valves are located at the back of the unit. The valve left of the pressure gauge is a 14 ½ lb. safety relief valve, and to the right of the pressure gauge, the operating valve.

Valves are working properly, when "OPERATING ZONE" indicates on the gauge by the pointer. The gauge pointer should not normally exceed the operating zone. If the pressure builds to 14 ½ lbs., the safety relief valve opens and releases pressure from the frypot.

**5-21. OPERATING CONTROL VALVE (Continued)**

**Cleaning Steps**

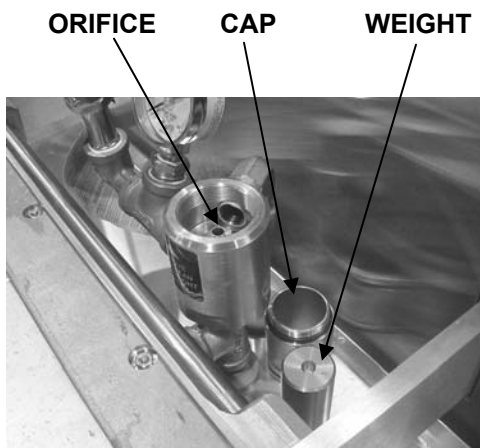

**DO NOT MANUALLY ACTIVATE THE SAFETY RELIEF VALVE.** Hot steam will be released from the valve when the ring is pulled. Keep away from safety valve exhaust, or severe burns could result.

1. AT THE END OF EACH DAY'S USAGE OF THE FRYER, THE OPERATING VALVE MUST BE CLEANED. The fryer must be OFF and the pressure released. Open the lid and then remove the dead weight valve cap and dead weight.



Failure to clean the operating valve daily could result in the fryer building too much pressure. Severe injuries and burns could result.

2. Wipe both the cap and weight with a soft cloth. Make certain to thoroughly clean inside cap, the weight seat, and around valve orifice.
3. Dry the parts and replace immediately to prevent damage or loss.

**5-22. REMOVAL & CLEANING OF SAFETY VALVE**

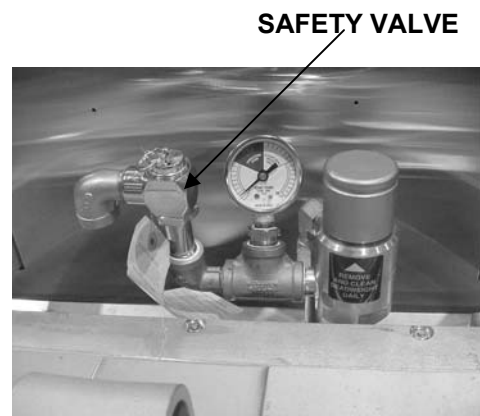

The safety relief valve should be cleaned once a year.

Do not attempt to remove valve while fryer is operating, or severe burns or other injuries could result.

1. Remove pressure gauge.
2. Use a wrench to loosen the valve from the elbow, turn counterclockwise to remove.

**5-22. REMOVAL & CLEANING OF SAFETY VALVE (Continued)**

- 3. Clean inside of the elbow with hot water.

**NOTE**

Turn the relief valve towards the left side of the fryer when reinstalling relief valve.

- 4. Immerse the safety relief valve in soapy water for 24 hours. Use a 1 to 1 dilution rate. The valve cannot be disassembled. It is factory preset to open at 14 ½ pounds of pressure. If it does not open or close, replace it!



**DO NOT DISASSEMBLE OR MODIFY THIS VALVE!**  
Tampering with this valve could cause serious injuries and also voids agency approvals and appliance warranty.

**5-23. PRESSURE GAUGE**

**Calibration Steps**

**PRESSURE GAUGE**

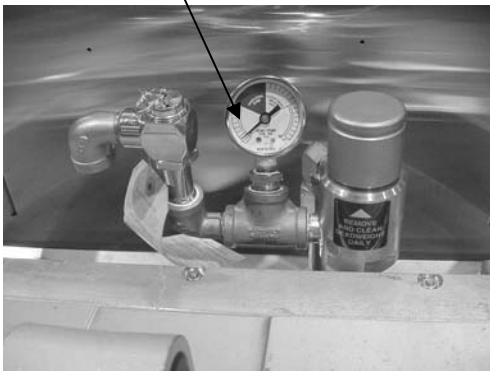

Recalibrate the pressure gauge if it is out of adjustment.

- 1. Remove the rim and glass.
- 2. If the indication hand shows a pressure or vacuum reading when it should stand at "0", turn the recalibrator screw in the same direction in the indicating hand is to be moved until the hand stands at proper "0" position.
- 3. Replace the rim and glass.

**Cleaning Steps**

- 1. Remove the gauge and check inside the pipefittings from dead weight body. Make certain fittings are clean and open.
- 2. Clean and reinstall the gauge.

**5-24. DRAIN VALVE REMOVAL**

The drain valve is found underneath the cookpot in the back of the fryer. It is opened by pulling the red knob in the front of the fryer, allowing the shortening to drain from the cookpot.

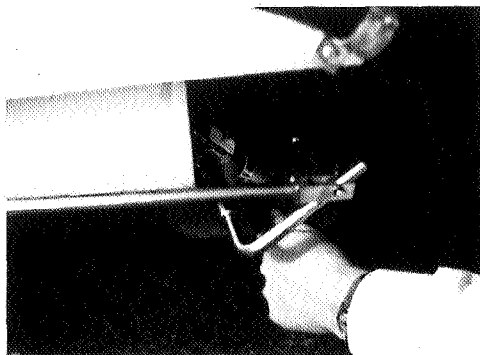
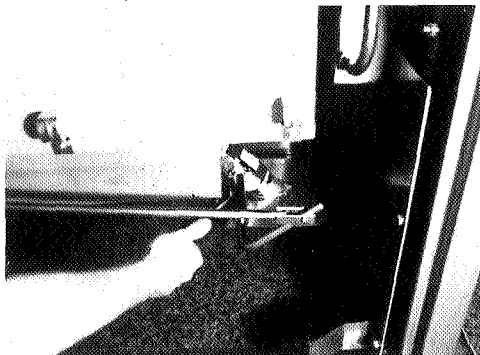
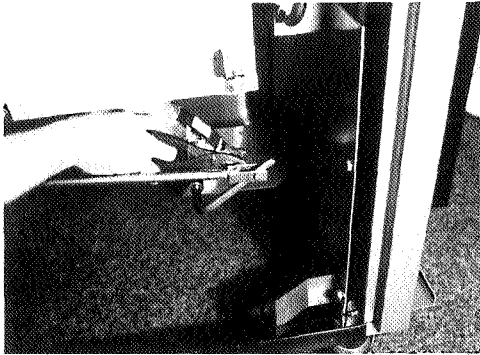

1. Drain the shortening from the cookpot.
2. Remove right side panel of fryer.
3. Remove the two cotter pins from the drain valve fitting and drain rod and pull extension from the drain valve, and let rod drop down.
4. Unscrew the drain shield from the valve.
5. Unscrew drain valve from the cookpot.
6. Replace new drain valve in reverse order.

## 5-25. NYLATRON STRIPS

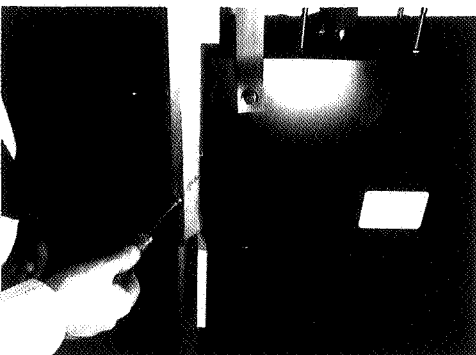
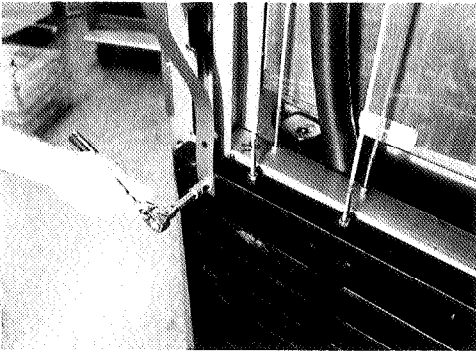
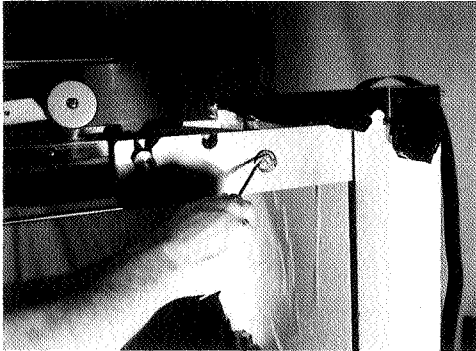

The nylatron strips fill the gap in the shroud behind the lid.

1. Secure the lid with the lid stop bracket.
2. Remove one of the tru-arc rings off of the lid pin and knock the pin out of the lid.
3. Lift the lid from the unit.

**WARNING**

The lid weighs 80 lbs. Care should be taken when lifting the lid to prevent personal injury.

4. With one person on each lid arm, release arms from the lid stop bracket and allow lid arms to rise all the way up.
5. Using a 3/8" socket remove the nuts securing the back shroud and remove the back shroud.
6. Remove bolts securing the strips to the weights, and remove strips from weights.
7. Remove the screws securing the front shroud.

5-25. NYLATRON STRIPS  
(Continued)

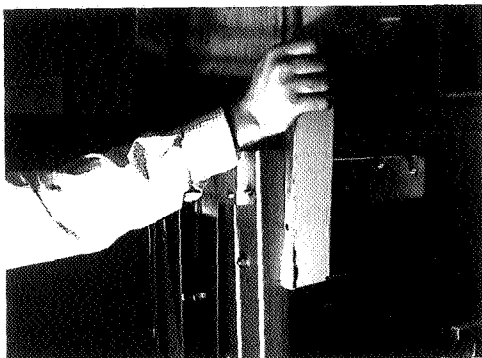

8. Lift the front shroud up and out, over the arms of the lid.
9. Thread the new nylatron strip through the track in the front shroud.
10. Lining up the holes in the strips, fit the front shroud over the lid arms and secure to carriage frame.

5-25. NYLATRON STRIPS  
(Continued)

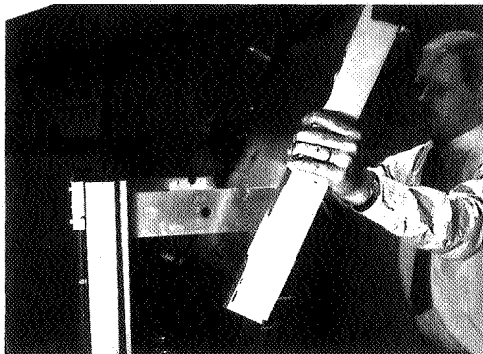

11. Secure the strips to the weights.

12. Replace back shroud and lid - replacement is complete.

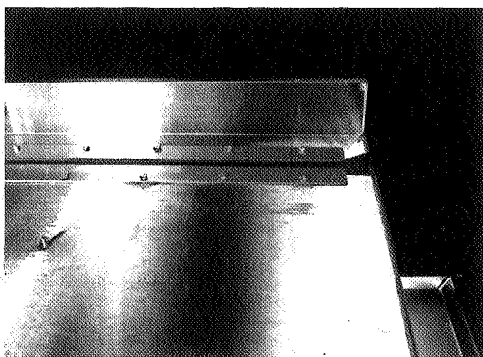

**SECTION 6. PROGRAMMING****6-1. BASIC PROGRAMMING SEQUENCE**

To enter the program mode, a password keystroke sequence is required. Note that when performing this sequence, the buttons must be depressed within one second of each other, If not, the control will not enter the program mode.

1. Depress the square under the far right digit of the display.
2. Depress the "Select Time" button.
3. Depress the square under the far left digit of the display.
4. Depress the "Exit Cool" button.

You are now in the program mode of the control.

**6-2. COOK CYCLE**

To program a cook cycle, the following steps should be followed.

1. Follow the keystroke sequence and enter the program mode.
2. Select the product you desire to program by depressing the cycle button next to the product.
3. TIME will be flashing in the function display.
4. Use the four change buttons beneath the display to change the displayed values. Program the starting time first.
5. Depress the SELECT TIME button, which allows you to enter the second interval for time.
6. Program your second interval time. Repeat until all six interval times have been programmed.
7. Depress the SELECT FUNCTION button. TEMP will be flashing in the function display.
8. Repeat steps 4, 5, and 6 until all six interval temperatures have been programmed.
9. Depress the SELECT FUNCTION button until PRESSURE is flashing in the function display. Digital display will read OFF and ON.
10. Follow steps 4, 5, and 6 until all six intervals have been programmed for pressure.
11. To exit program mode, depress EXIT FILL button.

**6-2. COOK CYCLE (Continued)****NOTE**

The above steps may be followed for interval alarms except you cannot program an interval alarm in the first interval.

Refer to Special Programming Modes on factory presets for load compensation, proportional control, and filter cycle counts.

**6-3. ERROR CODES**

The following defines the error code number. If an error code occurs, the buzzer will sound until you depress a cycle button. The control will continue to display the error code and fryer will be inoperative until error is corrected.

- E 5 - Pot temperature too high. (Software high limit)
- PROB - Temperature probe has failed.
- E 41 - Control Problem - must be initialized and programmed. (See One-Step KFC Parameters)

**6-4. SPECIAL PROGRAMMING MODES**

The special programming modes are entered by way of a special sequence of keys and are intended to be infrequently used for service or factory preset functions. The modes are numbered according to the cycle that is selected to enter them.

- KFC Parameters (Factory Preset) (Cycle 6)
- Test Procedures (Cycle 7)

To enter special programming mode, the following steps must be followed exactly.

1. Enter the password keystroke sequence for programming mode. Refer to "The Basic Programming Sequence."
2. Depress the EXIT COOL button. Display will read "SP"
3. Select the desired special function by depressing either cycle button 6 or 7.
4. Perform the desired operation.
5. Depress the EXIT FILL button to exit the special program mode. Unit will return to stand-by cook mode.

**NOTE**

The preceding steps must be followed exactly to enter the special program mode.

**6-5. ONE STEP KFC PARAMETERS**

1. Enter the special program mode.
2. Depress the cycle 6 button.  
Display will read as follows.

DISPLAY	E or O	F or C	BLANK	BLANK
Digit	4	3	2	1

Digit 1: Blank - When depressed, it will enter all KFC "Big Bird" cooking parameters. Display will read INIT for two seconds, then 2-75 for two seconds.

Digit 2: Blank - When depressed, it will enter all KFC cooking parameters. Display will read INIT for two seconds, then 2-50 for two seconds.

Digit 3: Display will read either F for Fahrenheit degrees, or C for Celsius degrees.

Digit 4: Display will read either E for Electric or O for Other (includes Gas).

**6-6. TEST PROCEDURES**

1. Enter the special program mode.
2. Depress the product 7 button. Display will be blank.
3. Depressing a certain button on the front panel turns an output on, while depressing the same button again turns that output off. This will test all circuits on the controller.

The table below shows the corresponding button with the output.



To avoid personal injuries or property damage when performing the solenoid and heat control test, be sure there is shortening in the cookpot. The heat could run uncontrolled. For test purposes only.

<b>Button</b>	<b>Device Activated</b>
Product One	Pressure Solenoid and Heat Control
Select Time	Product Indicators
Select Function	Function Indicators
Change Button Under Display 4	Change Button Indicator Display

**6-6. TEST PROCEDURES  
(Continued)**

Button	Device Activated
Change Button Under Display 3	Change Button Indicator Display
Change Button Under Display 2	Change Button Indicator Display
Change Button Under Display 1	Change Button Indicator Display

**NOTE**

The SELECT FUNCTION or SELECT TIME button must be depressed before the PRODUCT ONE button to properly perform the solenoid and heat control output test.

**WARNING**

For short duration only, unit will operate without temperature regulation, and the shortening will overheat.

**6-7. SPECIAL FUNCTIONS**

When programming one-step KFC parameters, load compensation and proportional control are automatically programmed into the control. The following defines these two functions.

**Load Compensation** - Load compensation adjusts cooking times to compensate for differences in the cooking process such as load size. The control is continuously comparing the pot temperature to the setpoint temperature. If the pot temperature is above the setpoint, the control will shorten the cook time. If the pot temperature is below the setpoint, the control will lengthen the cook time. Load compensation for KFC parameters is set at 0.

**Proportional Control** - Proportional control regulates pot temperature by pulsing the heat on and off until it reaches setpoint temperature. This allows better temperature accuracy when dropping product. Proportional control for KFC parameters is set at 10 degrees.

**RECOMMENDED  
SPARE PARTS FOR  
DISTRIBUTORS**

Recommended replacement parts, stocked by your distributor, are indicated with √ in the parts lists. Please use care when ordering recommended parts, because all voltages and variations are marked. Distributors should order parts based upon common voltages and equipment sold in their territory.

FIGURE & ITEM NO.	PART NUMBER	DESCRIPTION	UNITS PER ASSY
1	35726	COVER, Rear Shroud Stud Assembly.....	1
2	36632	CARRIAGE TRACK STUD ASSEMBLY, L.H .....	1
3	NS02-005	NUT, (#6-32 Hex Keys) .....	*
4	35057	SLIDE, Shroud (Inner).....	2
5	35248	SLIDE, Shroud (Outer).....	2
6	36839	SLIDE .....	2
7	62085	WELDMENT, Shroud .....	1
11	37233	PIN, Stop.....	2
15	37143	ASSEMBLY, Restrictor Weld.....	1
16	SC04-003	SCREW, THD Cutting (#8-32 x 3/8 P PHD - TYPE F).....	2
17	35053	PANEL, Left Side.....	1
18	35166	PANEL, Control Weldment.....	1
√	35859RB	PANEL, Control Assy. Complete – Non SMS .....	1
√	56817RB	PANEL, Control Assy. Complete – SMS .....	1
√	70957RB	PANEL, Control Assy. Complete – SMS - International .....	1
19	31299	STUD ASSY COVER, Control Panel – Non SMS .....	1
20	31271	HINGE SPRING – Non SMS .....	2
21	36365	ASSEMBLY, Weld Stud & Spacer – Non SMS .....	1
22	29382	DECAL, Membrane Switch-KFC – Non SMS.....	1
22	56528	DECAL, Membrane Switch-KFC - SMS .....	1
√ 23	16624	LIGHT, Indicator (250V).....	3
√ 23	54085	LIGHT, Indicator – Green (CE).....	3
√ 24	29898	SWITCH, Power .....	1
25	35832	ASSEMBLY, 8 HD FRYER PCB– Non SMS .....	1
26	51737	CONDENSATION PAN ASSEMBLY .....	1
28	35912	DECAL, Fill Instructions.....	1
29	37246	CASTER, w/Brake.....	2
30	35181	COVER, Drain Rod Access .....	1
31	SC02-034	SCREW, (#8-AB or A x 1 .....	2
32	35703	LATCH, Drain Rod .....	1
33	35705	LATCH, Retainer, Drain Rod.....	1
34	35919	BLOCK, Latch Mounting .....	1
35	SC01-034	SCREW, Machine (#8-32 x 3/8).....	2
36	36185	LATCH, Filter.....	1
37	35855	LATCH PLATE, Drain Rod .....	1
38	35899	LATCH PLATE SPACER.....	1
39	17612	INSERT, Leg Casting .....	2

√ Recommended Parts

FIGURE & ITEM NO.	PART NUMBER	DESCRIPTION	UNITS PER ASSY.
40	EF02-072	BUSHING, Split (3/4) .....	1
41	35107	BRACKET, Drain Rod Weldment .....	1
42	35177	PANEL, Right Side w/Access Hole. ....	1
43	35154	CASTER .....	2
44	NS03-017	NUT, (#U Type Clip) .....	1
45	35179	COVER, Access Cover.....	1
46	SC02-023	SCREW, (#8-B x 3/8" PH THD SS) .....	5
47	35416	WELDMENT, Contactor Bracket .....	1
48	NS02-002	NUT, (1/4-20 Hex Keps) .....	2
49	35677	CLAMP, Power Cord .....	1
50	SC04-011	SCREW, (#8-32 x 1/2" Slot Hex HD SS) .....	4
51	NS01-015	NUT – 1/4-20 HEX (SN: GG015JJ & BELOW).....	2
52	35924	BUSHING PLATE (SN: GG015JJ & BELOW) .....	1
53	36075	SPRING, Magnet Plate (SN: GG015JJ & BELOW).....	1
54	LW01-012	LOCKWASHER, (#10 Split Ring SS) .....	2
55	SC01-055	SCREW, (#10-32 x 3/4" Hex HD SS). ....	2
56	35923	PLATE/STUD ASSY (SN: GG015JJ & BELOW) .....	1
57	35455	PLATE, Magnet Mounting.....	1
58	WA01-002	WASHER, (1/4 Type B-Series R) .....	2
59	SC04-006	SCREW, (1/4-20 x 1/2" Hex HD C) .....	2
61	NS02-010	NUT, (5/16-18 Hex Keps SS) .....	8
63	SC01-042	SCREW, (3/8-16 x 1" Hex HD) .....	2
64	SC01-104	SCREW, (1/4-20 x 1 1/2" Hex HD) .....	2
65	LW01-001	LOCKWASHER, (3/8 Split Ring) .....	4
66	35484	LOCKPLATE, Hookarm .....	2
67	EF02-003	WIRE TIE.....	*
68	35299	GUARD, Splash .....	1
69	37294	CARRIAGE TRACK STUD ASSEMBLY, R.H .....	1
70	MS01-291	RUBBER CYL. SPRING .....	2
71	SC01-081	SCREW, (3/8-24 x 3/4" Hex HD S.....	2
72	NS01-011	NUT, (#10-32 Hex) .....	*
73	35954	PLATE, Support Pulley .....	6
74	36851	BRACKET, Hose .....	1
75	37291	BACK, Shroud.....	1
76	35962	BRACKET, Wheel Assembly .....	2
77	37235	BRACE, Carriage Track.....	2
78	35244	SPACER, Top Frame Brace .....	2
79	36561	TOP FRAME BRACE.....	1
80	SC01-160	SCREW, (1/4-20 X 1 1/4" Hex HD.....	4
81	SC01-132	SCREW, (1/4-20 X 5/8" Soc. HD CAP SS).....	8
82	35725	ADAPTER, Hose Exhaust.....	1
√ 83*	36210	REPLACEABLE BEEPER .....	1
√ 83*	51877	WIRE/SPEAKER ASSY – SMS .....	1
84*	51292	FAST CONTROL DECAL .....	1

√ Recommended Parts

\*not shown

FIGURE & ITEM NO.	PART NUMBER	DESCRIPTION	UNITS PER ASSY
85*	35976	TERMINAL BLOCK, Assembly – 240V, 50 Hz, 3 ph.....	1
86*	EF02-120	CONDUIT CLAMP – 1.25” – 2 HOLE (power cord).....	1
87*	14244	KIT, 580 Conversion to SMS – Domestic .....	1
87*	14361	KIT, 580 Conversion FAST to SMS – Domestic .....	1
87*	14244	KIT, 580 Conversion FAST to SMS 380-415V – Domestic .....	1
87*	14747	KIT, 580 Conversion FAST to SMS – International .....	1
87*	14748	KIT, 580 Conversion FAST to SMS – 380-415V– International..	1
87*	14752	KIT, 580 Conversion to SMS – International.....	1

\*not shown

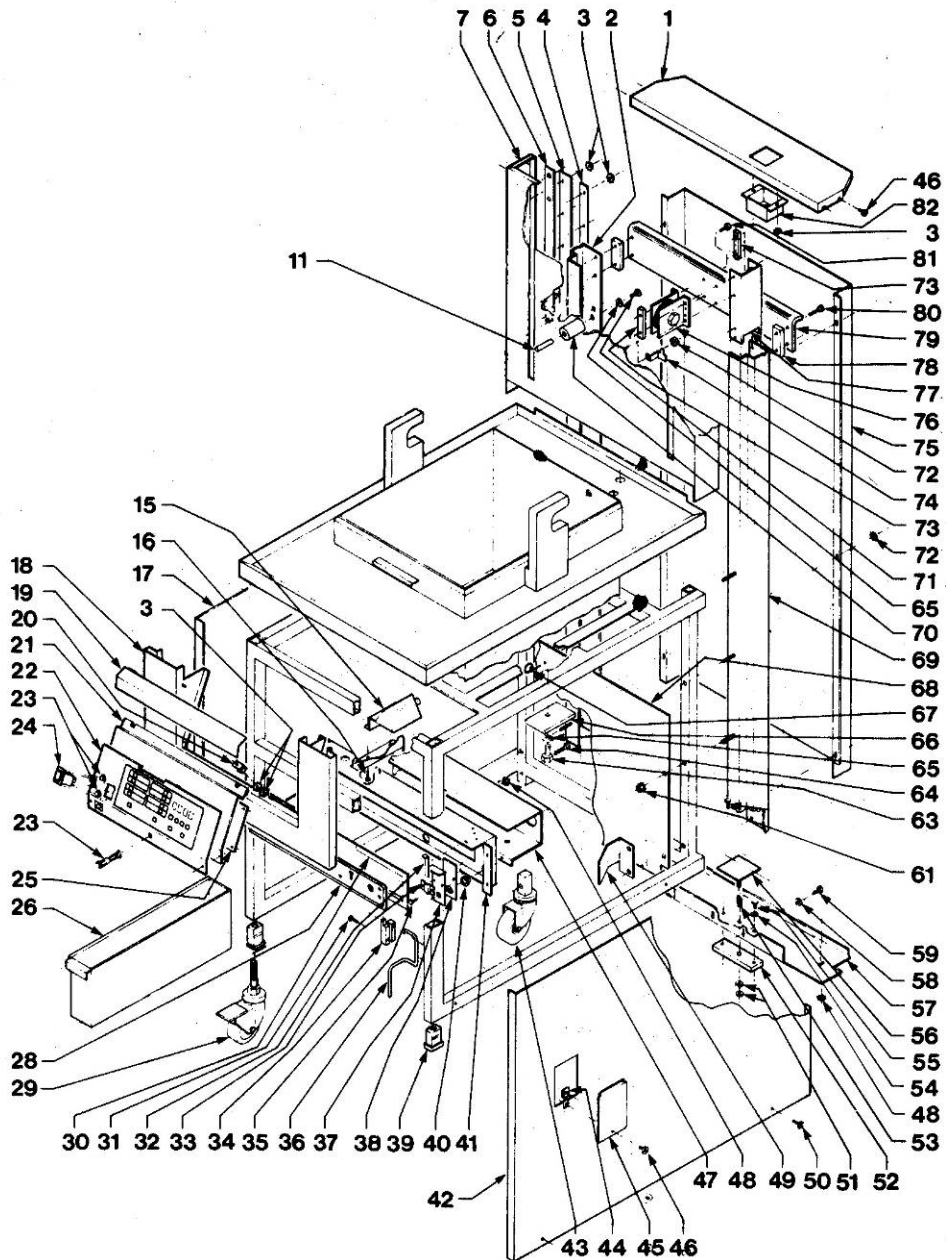

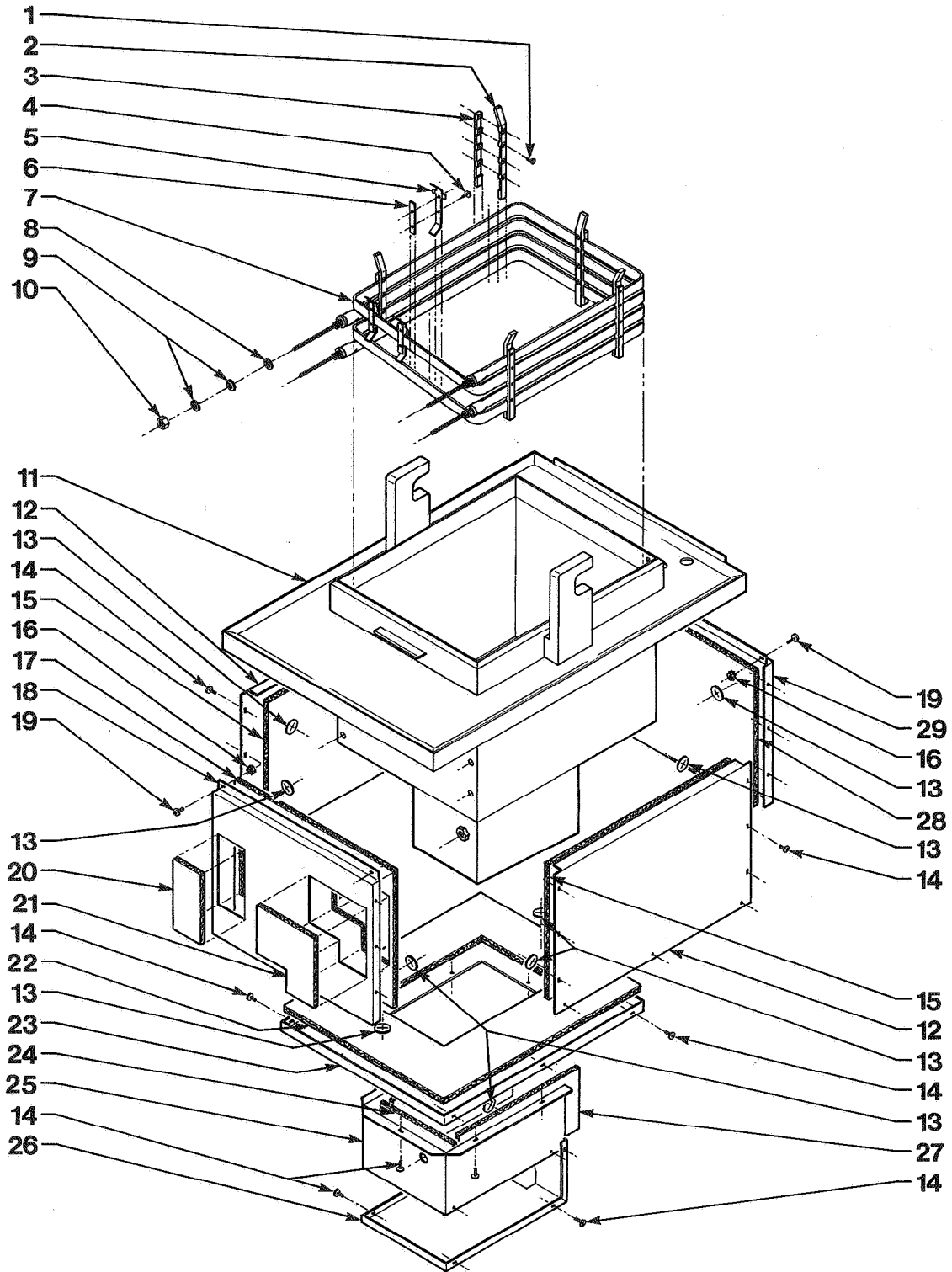

FIGURE & ITEM NO.	PART NUMBER	DESCRIPTION	UNITS PER ASSY
1	SC01-083	SCREW, (#10-32 x 1/2 PH FHD)	*
2	35101	SUPPORT, Element - Long	5
3	35100	SUPPORT, Element - Short	5
4	SCO1-074	SCREW, (#10-32 x 1/2 PH THD S)	*
5	35435	BRACKET, Hi Limit Probe	3
6	35462	BRACKET, Hi Limit Probe	3
√ 7	35234	HEAT ELEMENT ASSEMBLY, 8.5 KW 208V	2
√	35598	HEAT ELEMENT, 8.5 KW 240V	2
√	48367	HEAT ELEMENT, 230 V(Int'l Only)	2
√	36290	HEAT ELEMENT, 220 V(Int'l Only)	2
8	16855	SEAL, O-Ring	4
9	WA01-005	WASHER, (5/8 Dia. Type A - Series N)	8
10	NS01-017	NUT, (5/8-18 B Hex)	4
11	<b>Not Avail.</b>	WELDMENT, Pot & Countertop	1
12	35797	WELDMENT, Insul. Box Upr. Middle	2
13	WA02-001	WASHER, Insulation 1-1/2 x.015	*
14	SC03-005	SCREW, (#8-AB x .50 PH PHD)	*
15	35519	INSULATION, Side Panel	2
16	NS02-007	NUT, (#8-32 C Hex Keps)	4
17	35326	INSULATION, Upper Front	1
18	35531	WELDMENT, Insulation Box (Front)	1
19	SC01-053	SCREW, (#8-32 x 1/2 PH RHDS)	1
20	35328	INSULATION, Front Cutout 3.19 x 7.00	1
21	35327	INSULATION, Front Cutout 6.5 x 7.00	1
22	35334	INSULATION, Middle	1
23	35529	WELDMENT, Insulation Box, (Middle)	1
24	35333	INSULATION, Bottom Back	1
25	35528	WELDMENT, Insulation Box, (Bottom)	1
26	35081	BOX, Insulation, Bottom	1
27	35332	INSULATION, Bottom Sides	2
28	35329	INSULATION, Upper Rear	1
29	35530	WELDMENT, Insulation Box, (Rear)	1

√ Recommended Parts

\*As Required

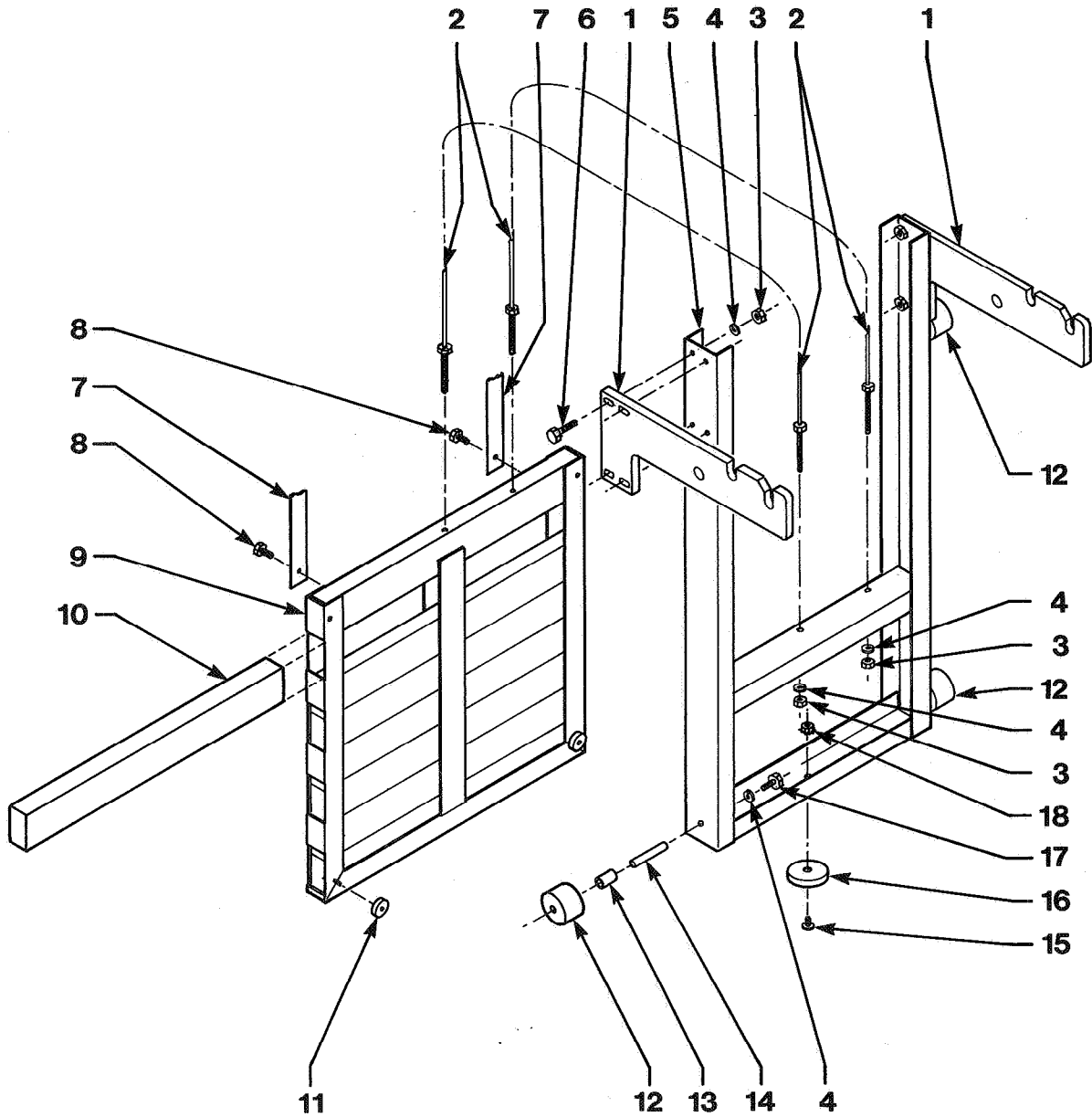

FIGURE & ITEM NO.	PART NUMBER	DESCRIPTION	UNITS PER ASSY.
1	35026	ARM, Lid Support	2
√ 2	35207	CABLE	2
3	NS01-025	NUT, HEX 5/16-18 SS	10
4	LW01-010	WASHER, 3/8 Split Ring SS	10
5	35092	CARRIAGE	1
6	SC01-069	SCREW, 3/8-16 x 1-1/2 Hex HD S2P	8
7	36839	SLIDE	2
8	SC01-042	SCREW, 3/8-16 x 1 Hex C	2
9	36625	WELD ASSEMBLY, C/W Carriage	1
10	36627	COUNTERWEIGHT BAR	7
11	36626	SPACER, C/W Frame	2
12	37362	WHEEL, Carriage	4
13	37363	SPACER, Carriage Wheel	4
14	37364	SPINDLE	4
15	SC01-009	SCREW, 1/4-20 x 1/2 P THD	1
16	35438	MAGNET, Ceramic (Small)	1
17	SC01-081	SCREW, 3/8-24 x 3/4 Hex HD SS	4
18	NS02-002	NUT, 1/4-20 Hex Keps	1

√ Recommended Parts

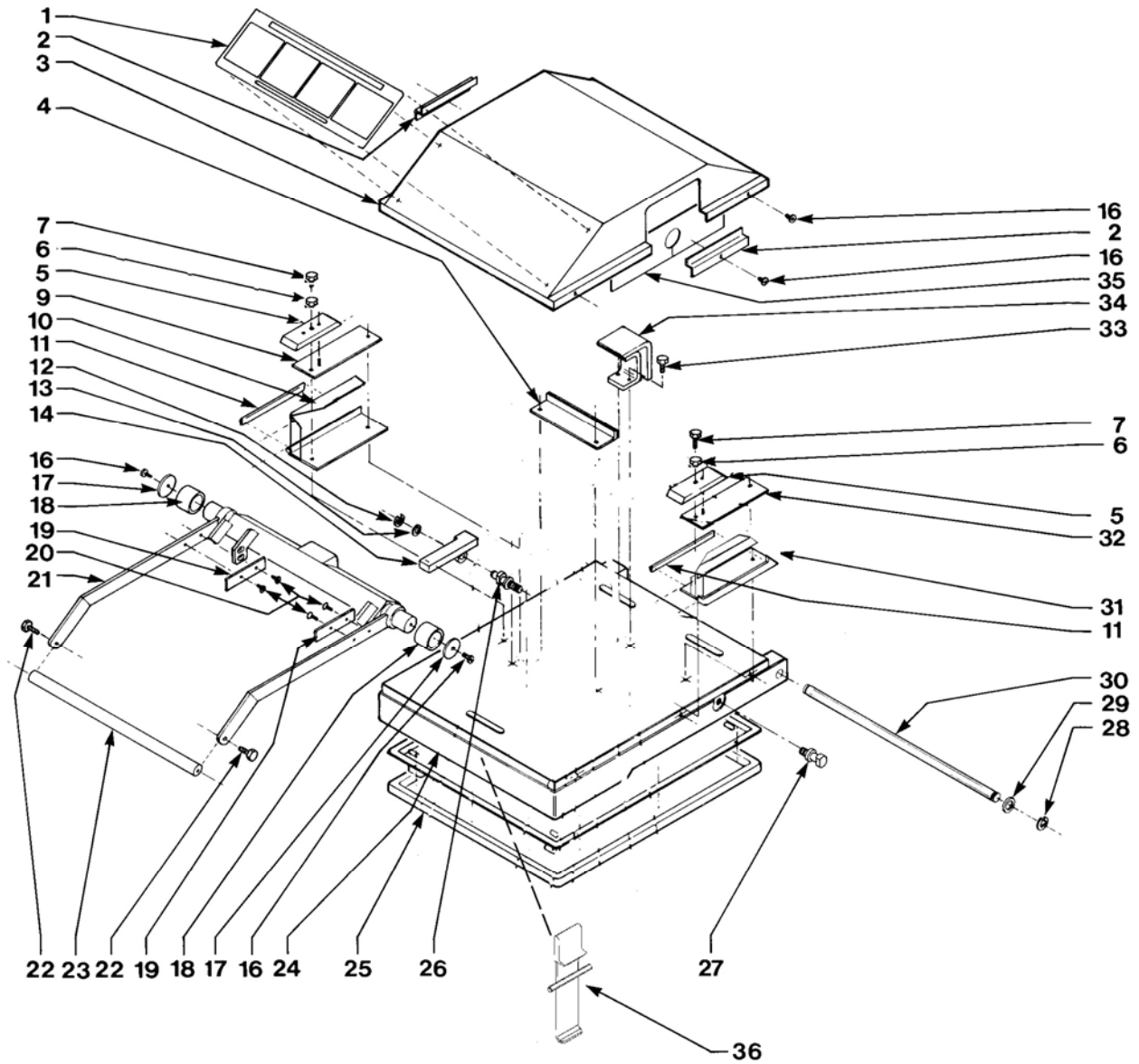

FIGURE & ITEM NO.	PART NUMBER	DESCRIPTION	UNITS PER ASSY
1	35792	LID INSTRUCTION LABEL .....	1
2	35675	FILLER, Lid .....	2
3	35243	COVER, Lid, Main.....	1
4	35413	PLATE, Trip .....	1
√ 5	52627	Pressure Pad Assembly.....	2
5	49864	Pressure Pad (use 52627).....	2
6	49852	Bushing (not shown).....	2
7	SC01-204	Screw 1/4-20 x 1.00 Sock Butt Hd .....	2
8	37171	SHIM, Lid (.030).....	1
9	49962	PLATE, Shim Assembly (L.H.) .....	1
10	49890	PLATE, Cam Guide (L.H.).....	1
11	35359	SLIDE, (6").....	2
12	16121	RING, (Tru-Arc) Latch Pin .....	1
13	WA01-020	WASHER, Lid Stop.....	1
14	51531	CAST, Lid Stop .....	1
16	SC01-074	SCREW, #10-32 x 1/2 PH THD SS .....	8
17	35223	WASHER, Special.....	1
18	35227	ROLLER, Linkage Shaft .....	2
19	35339	GUIDE, Handle Side .....	2
20	SC01-062	SCREW, #6-32 x 3/8 PH FH.....	4
22	SC01-041	SCREW, 5/16-18 x 1.00 Hex HD C .....	2
23	36285	WELDMENT, Handle Tap Plate.....	1
√ 25	34526	GASKET, LID - SN: AC0712021 & below .....	1
√ 25	66620	GASKET, LID - SN: AC0712022 & above .....	1
26	35945	PIN, Lid Support.....	1
27	35032	PIN, Lid Support.....	1
28	RR01-010	RING, Ret. 3/4 Shaft SS .....	2
29	36312	WASHER, Lid Hinge .....	2
30	51697	PIN, Lid Hinge.....	1
31	49895	PLATE, Cam Guide (R.H.) .....	1
32	49963	PLATE Shim Assembly (R.H.) .....	1
33	SC01-146	SCREW, 1/4-20 x 3/4 Hex HD SS .....	2
34	52477	LIFT, Lid .....	1
√ 35	35465	CAM SLIDE FILLER .....	2
36	52497	LATCH ASSEMBLY, Coated .....	1
37	72377	ASSY – REBUILT LID .....	1
38	52498	LATCH SPRING (not shown) .....	1
39	SC01-214	SCREW, Latch, 10-32 x 1 PH THD SS (not shown).....	2
40	LW02-006	LOCKWASHER, Latch (not shown).....	2
41	52728	SHIM, Lid Lift (not shown).....	1

√ Recommended Parts

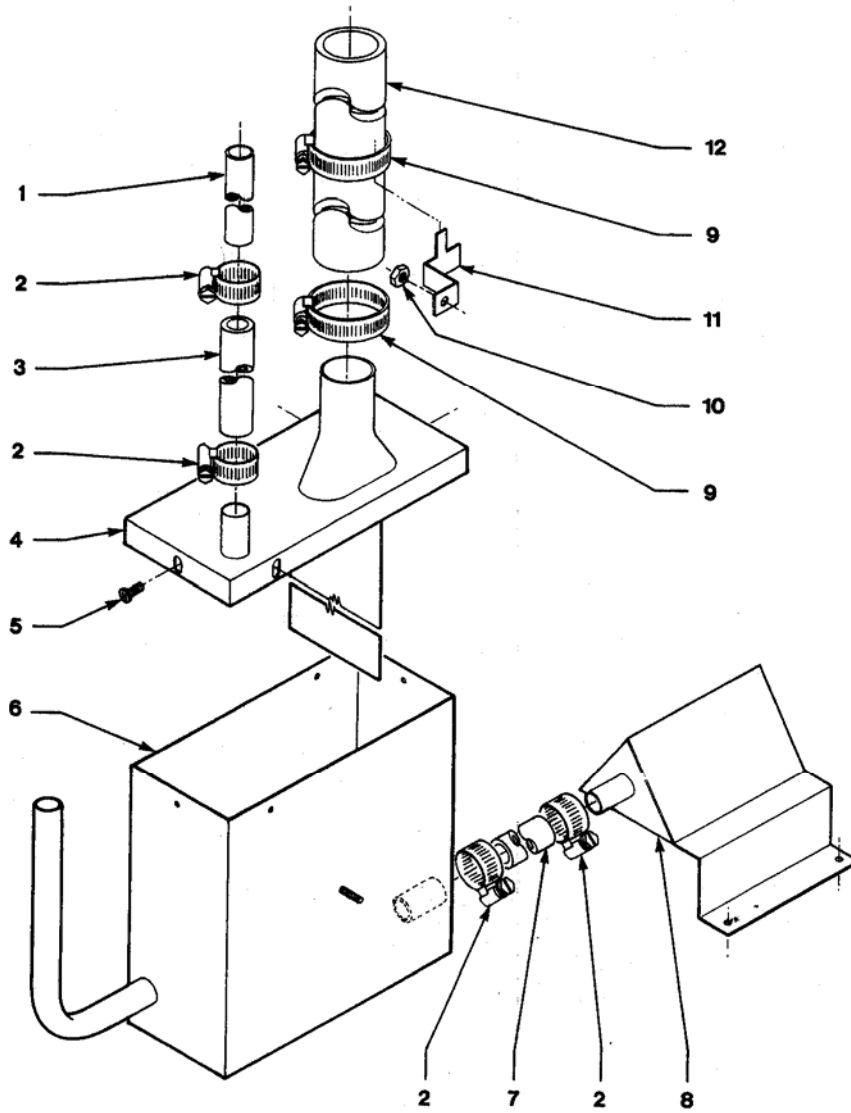

FIGURE & ITEM NO.	PART NUMBER	DESCRIPTION	UNITS PER ASSY.
1	35686	TUBE, DW to Exhaust Stack SS .....	1
2	MS01-297	HOSE CLAMP, SS - .500 – 1.062 DID.....	4
3	35693	TUBE, Exhaust Connect .....	1
4	35696	WELDMENT, Steam Exhaust Box Lid.....	1
5	SC02-014	SCREW, #8 AB x 3/8 P THD SS .....	4
6	35687	WELDMENT, Steam Exhaust Box .....	1
7	35694	TUBE, Condensate.....	1
8	70312	ASSEMBLY, Restrictor Weld.....	1
9	MS01-315	HOSE CLAMP, 1/2 x 1-3/4 SS.....	2
10	NS01-011	NUT, (#10-32 Hex).....	1
11	36851	BRACKET, Hose.....	1
12	21877	TUBING, Steam Exhaust.....	4

NOTE: TURN RELIEF VALVE TOWARDS  
LEFT SIDE OF COOKER

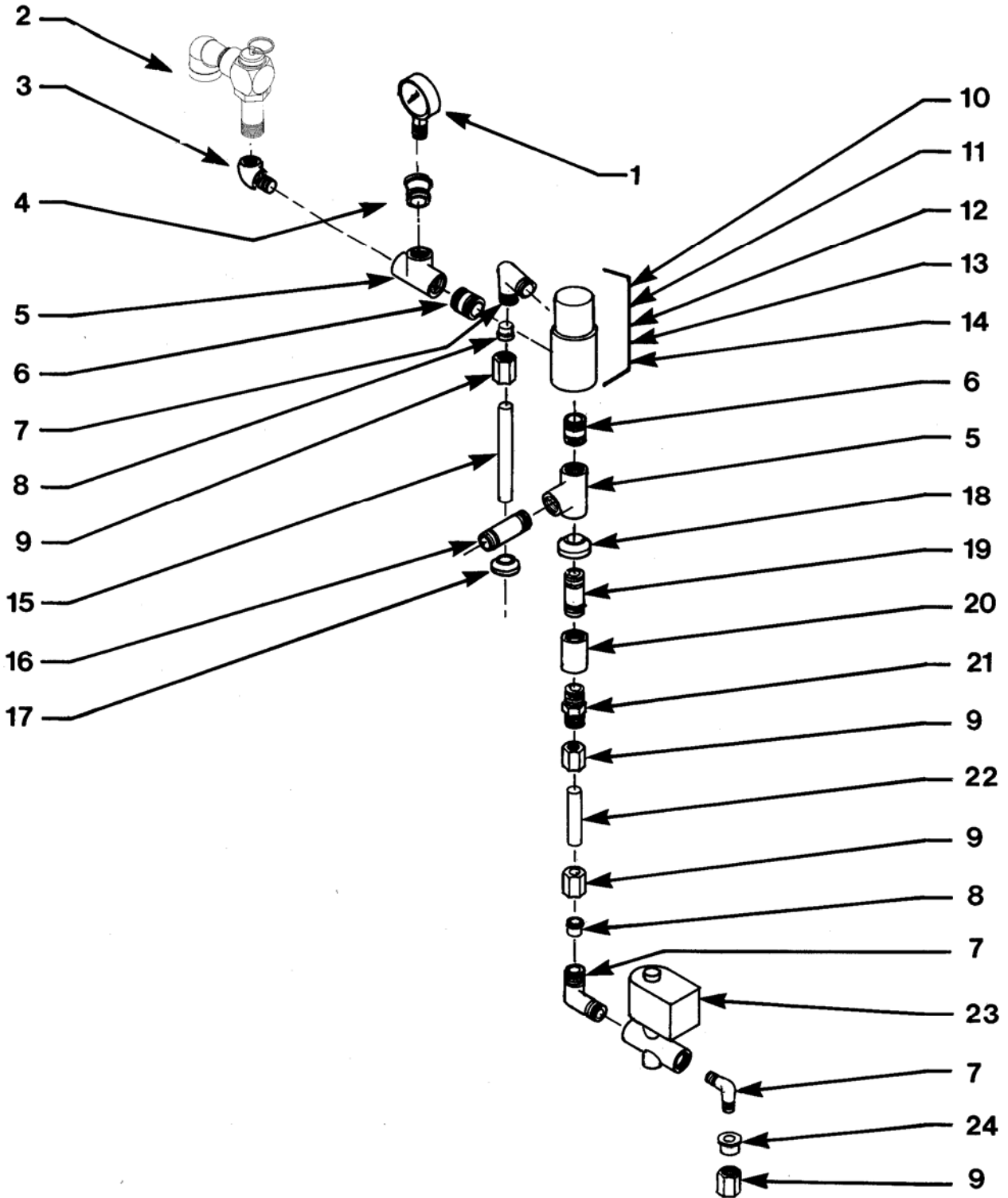

FIGURE & ITEM NO.	PART NUMBER	DESCRIPTION	UNITS PER ASSY
√ 1	16910	PRESSURE GAUGE.....	1
√ 2	59742	RELIEF VALVE ASSY .....	1
3	FP01-127	ELBOW, Street, ½ x ½, 90 Degree .....	1
4	FP01-063	REDUCER, ½ NPT M to ¼ NPT F.....	1
5	FP01-011	PIPE TEE, ½ NPT 304 SS.....	2
6	FP01-028	NIPPLE, Close ½ NPT .....	2
7	17407	CONNECTOR, ½ Male Elbow .....	3
8	16817	FITTING, Sleeve Teflon .....	*
9	16809	NUT FITTING.....	*
10	56307	CAP, Dead Weight .....	1
11	16902	SEAL "O" RING .....	1
12	16903	DEAD WEIGHT .....	1
13	16918	ORIFICE, 12 PSI.....	1
14	16852	BODY, Valve .....	1
15	35686	TUBE, DW to Exhaust Stack .....	1
16	35817	PIPE NIPPLE, ½ x 2 ¼ SS .....	1
17	16804	UMBRELLA GROMMET .....	1
18	35200	UMBRELLA GRAMMET .....	1
19	35474	PIPE NIPPLE, ½ x 2.....	1
20	FP01-066	COUPLING, ½ NPT SS .....	1
21	16807	FITTING CONNECTOR, Male .....	1
22	35147	TUBE, Steam Exhaust - Up.....	1
23	18721	VALVE, Solenoid.....	1
24	16808	FITTING SLEEVE, Steel.....	1

√ Recommended Parts

\*As Required

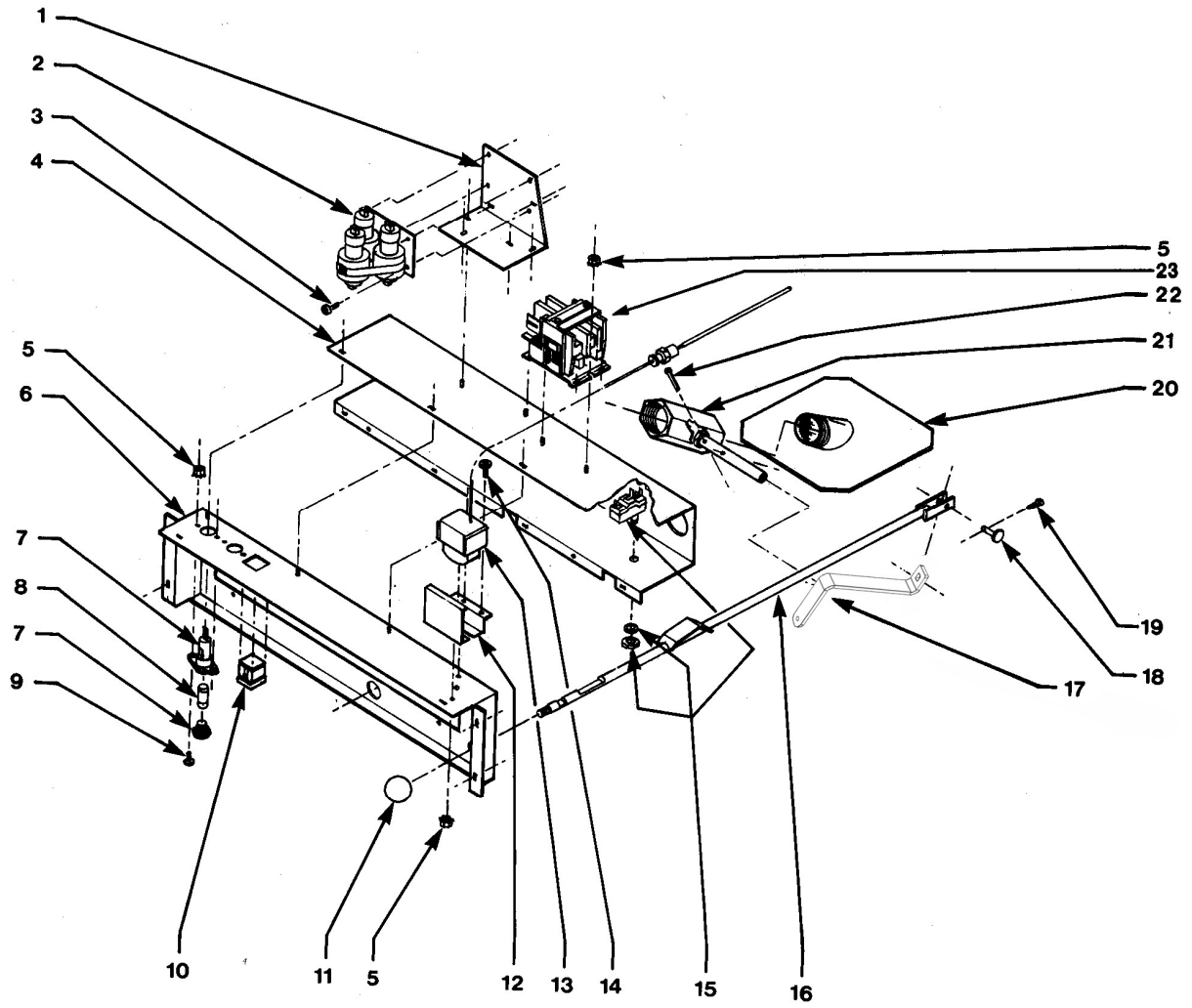

FIGURE & ITEM NO.	PART NUMBER	DESCRIPTION	UNITS PER ASSY.
1	19683	BRACKET, Mercury Contactor	1
√ 2	29942	CONTACTOR, Mercury 208/240 VAC	1
√ 2*	65075	E/M HEAT CONTACTOR-CE-240V (UK)	1
√ 2*	65074	E/M HEAT CONTACTOR-CE-230V	1
3	SC04-003	SCREW, #8-32 x 3/8 P PHD	2
4	35416	WELDMENT, Contactor Bracket	1
5	NS02-005	NUT, #6-32 Hex Keys	*
6	35107	BRACKET, Drain Rod Weldment	1
√ 7	EF02-006	FUSE HOLDER	2
√ 8	EF02-007	FUSE, 15 Amp	2
9	SC01-010	SCREW #6-32 x 1/2 PH PHD	4
10	MS01-197	RECEPTACLE, NEMA 5-15	1
10	56063	CORD ASSY, - CE	1
10	14721	KIT, 580 Receptacle Non-CE to CE	1
11	16102	SPINDLE KNOB, Red	1
12	17216	BRACKET, Hi-Limit Probe	1
√ 13	16738	TEMP. CONTROL, Hi-Limit - 450F	1
14	SC04-004	SCREW, #8-32 x 3/8 P PHD	2
√ 15	18227	MICROSWITCH	1
16	35132	DRAIN ROD HANDLE	1
17	55139	LEVER – DRAIN VALVE	1
18	PN01-012	CLEVIS PIN, 1/4 x 1 SS	1
19	PN01-002	COTTER PIN, 3/32 x 3/4 S	1
20	35521	SPLASH GUARD ASSEMBLY	1
21	55137	DRAIN VALVE & COUPLING ASSEMBLY.	1
22	17255	COTTER PIN, 9/64 x 1 ¼	2
23	19405	CONTACTOR 208/240 VAC	1
√ 24	14329	PROBE KIT – W/O SMS (Not Shown)	1
√ 24	14335	PROBE KIT – W/SMS (Not Shown)	1
25	56065	ADAPTOR, CORD ASSY. – 580 to PF-180 (used in conjunction with 56063 with units of SN: AG005II and below)	1
√	51057	<b><u>Additional Parts for the European Community Units</u></b> FILTER, ASSEMBLY-EMC (Not Shown)	1
	48369	SWITCH, COVER- Plastic (Not Shown)	1

√ Recommended Parts

\*Not Shown



NOTE: FOR SUPPLY CONNECTIONS  
USE COPPER STRANDED WIRE

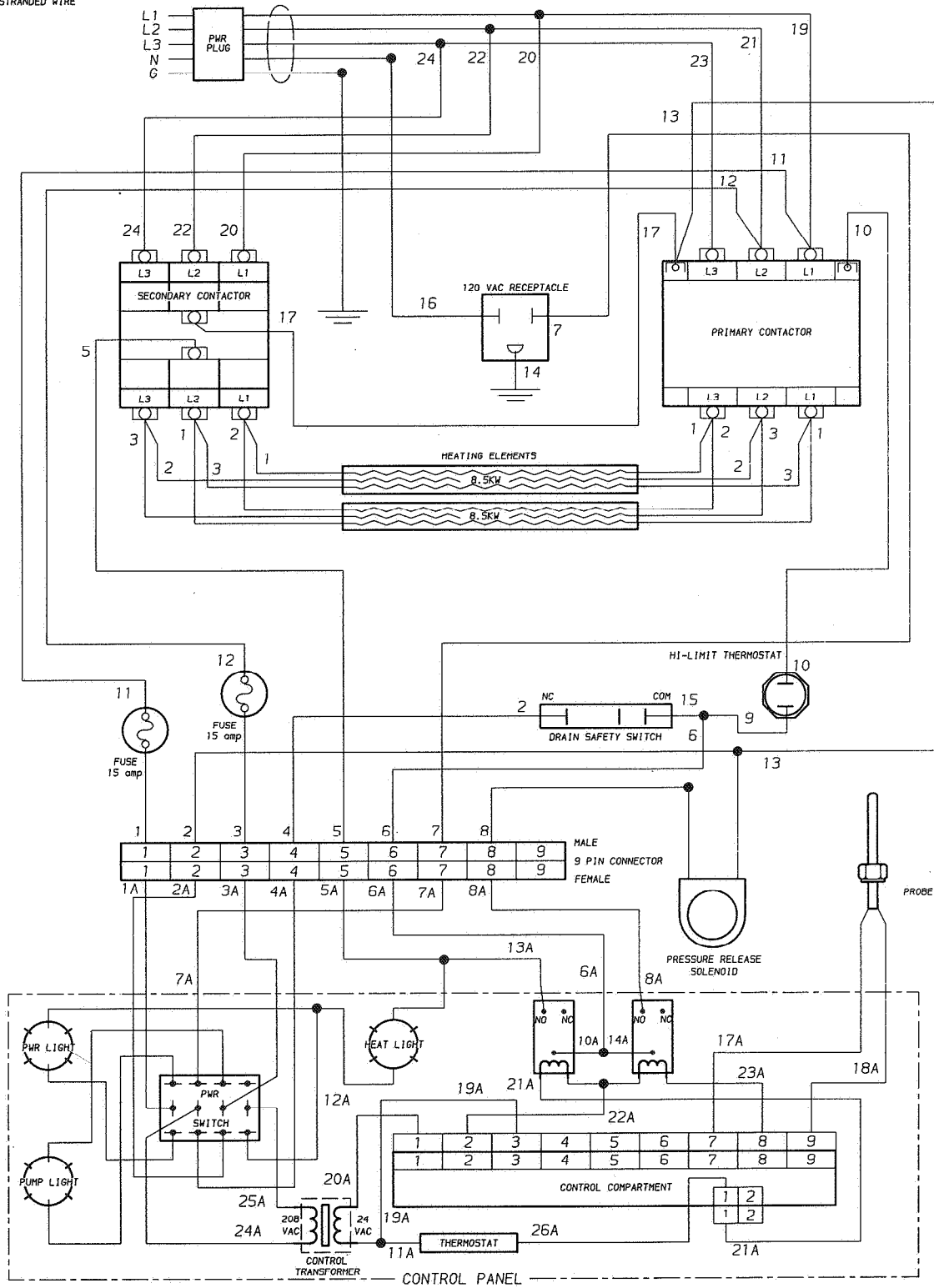

MODEL 582 ELECTRIC FRYER  
17KW 120/208VAC  
3PH 4WIRE W/GRND

35761

NOTE: FOR SUPPLY CONNECTIONS  
USE COPPER STRANDED WIRE

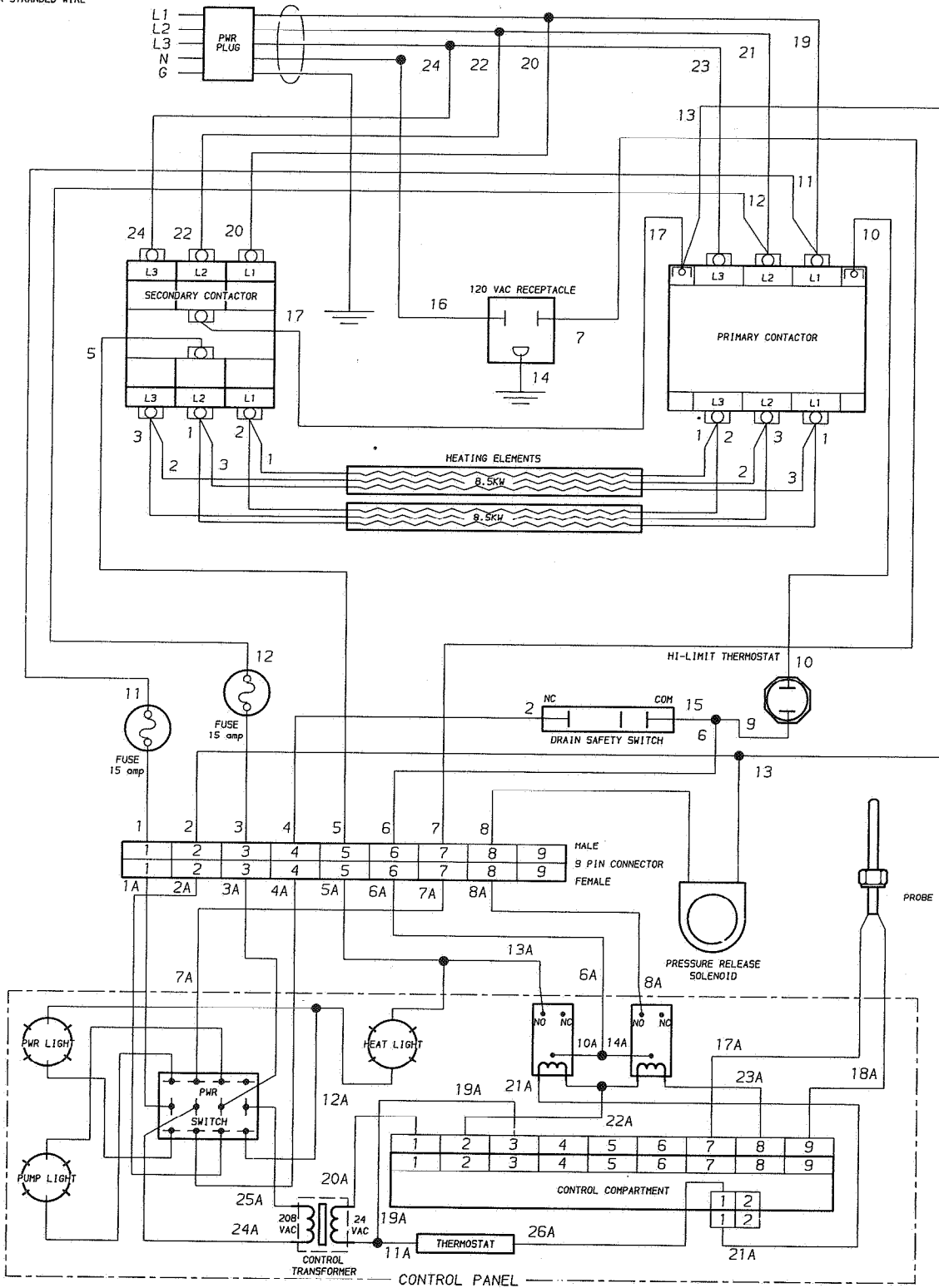

MODEL 582 ELECTRIC FRYER  
17KW 120/240VAC  
3PH 4WIRE W/GRND

35764

NOTE: FOR SUPPLY CONNECTIONS  
USE COPPER STRANDED WIRE

DO NOT CONNECT L1& L2 TO  
A CIRCUIT AT MORE THAN  
150 VOLTS TO GROUND

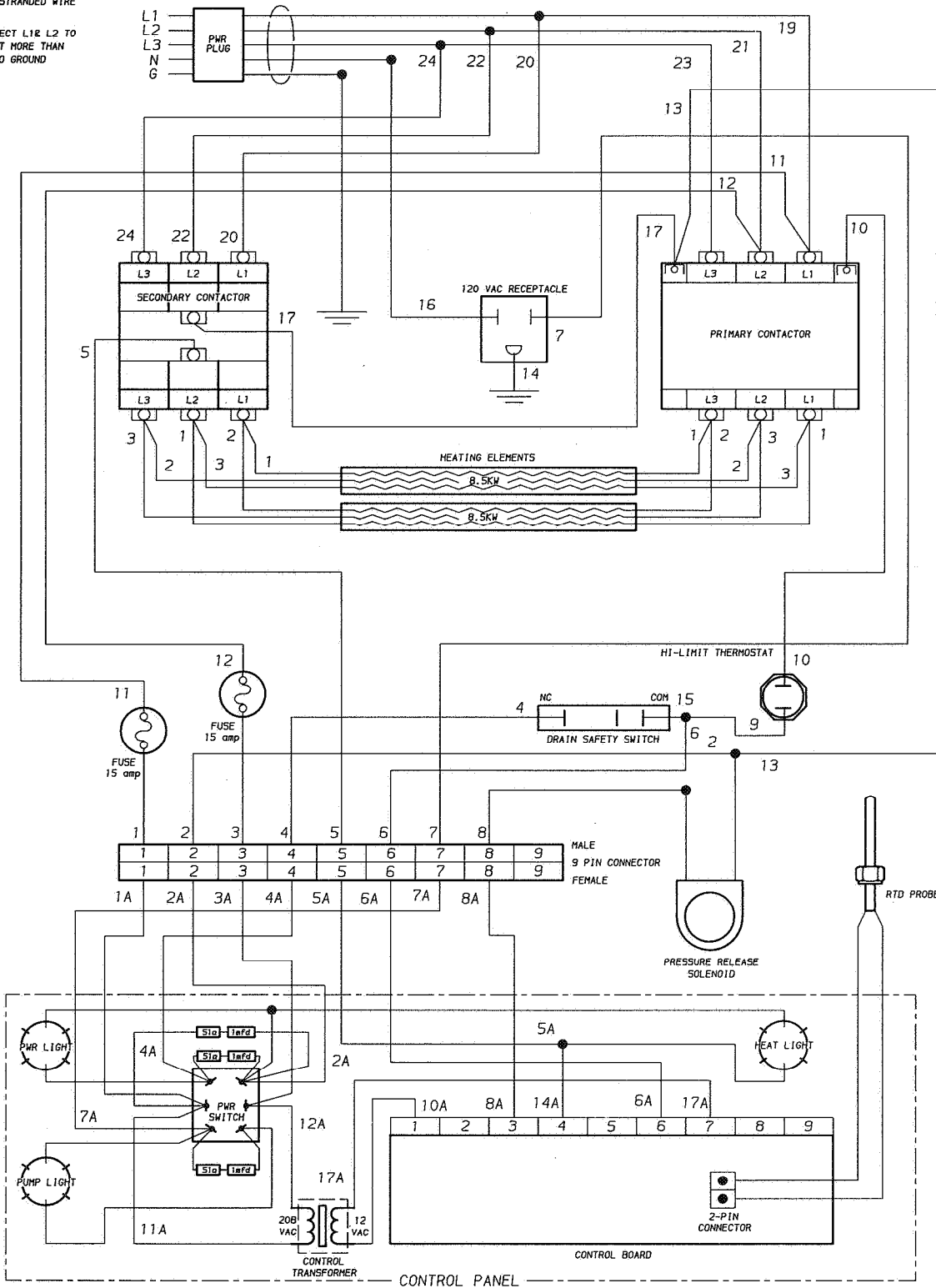

MODEL 580 ELECTRIC FRYER  
17KW 120/208VAC  
3PH 4WIRE W/GRND

35172

NOTE: FOR SUPPLY CONNECTIONS  
USE COPPER STRANDED WIRE

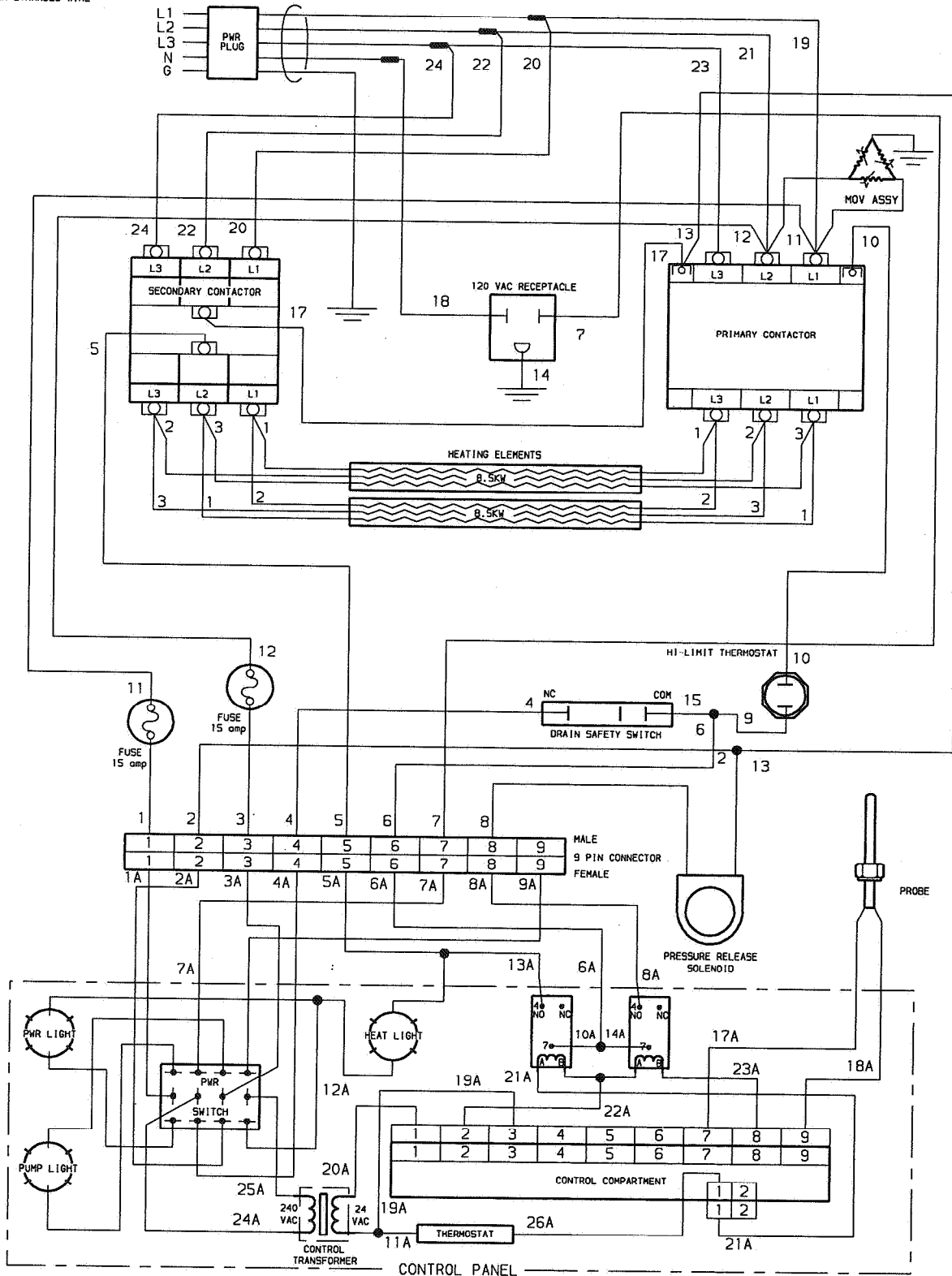

MODEL 582 ELECTRIC FRYER  
17KW 120/240VAC  
3PH 4WIRE W/GRND

35764

NOTE: FOR SUPPLY CONNECTIONS  
USE COPPER STRANDED WIRE

DO NOT CONNECT L1 & L2 TO  
A CIRCUIT AT MORE THAN  
150 VOLTS TO GROUND

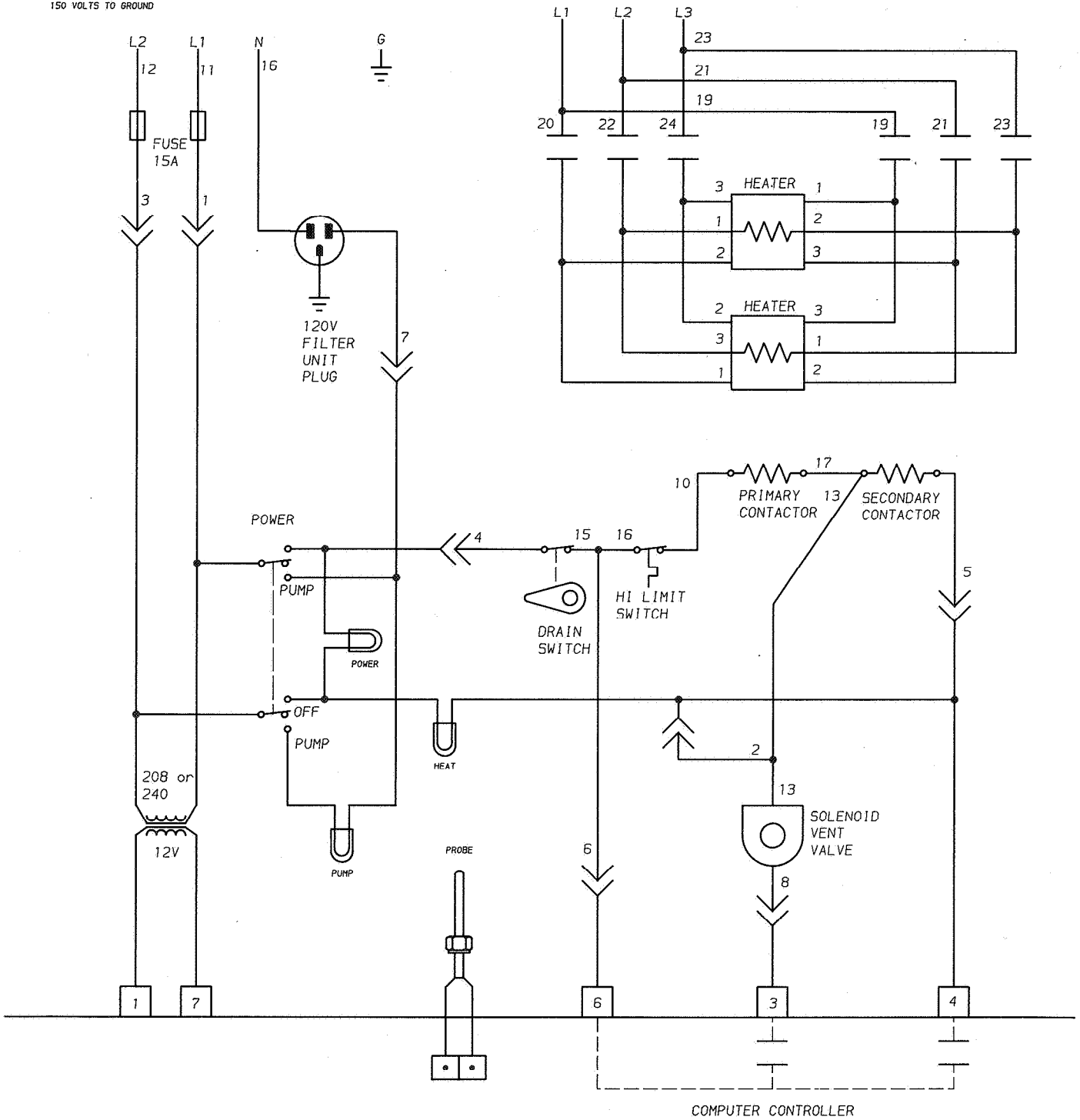

MODEL 580 ELECTRIC FRYER

3PH 4WIRE W/GRND

36178

NOTE: FOR SUPPLY CONNECTIONS  
USE COPPER STRANDED WIRE

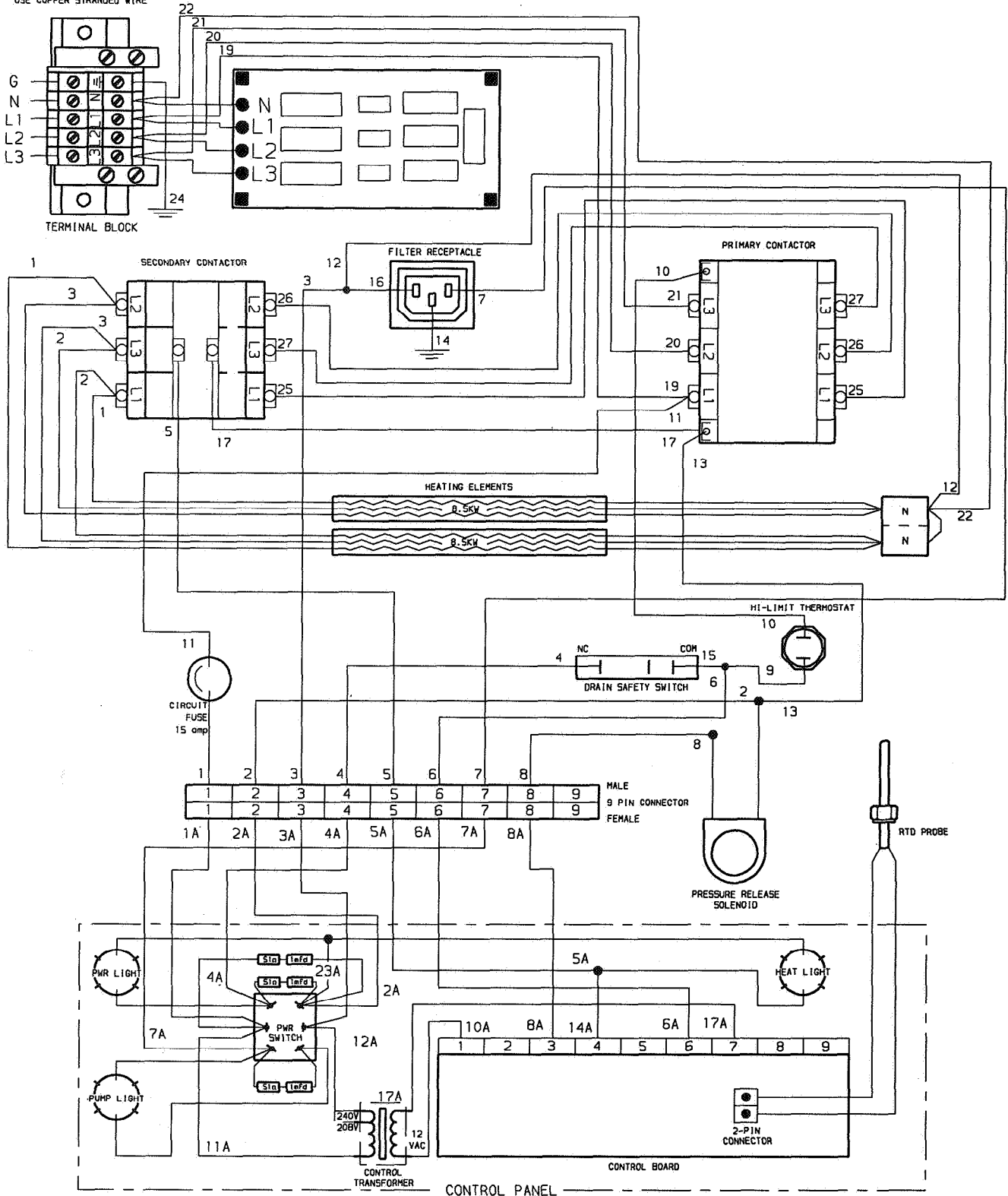

MODEL 580 ELECTRIC FRYER

400V 17KW 3N~

34440

NOTE: FOR SUPPLY CONNECTIONS  
USE COPPER STRANDED WIRE

DO NOT CONNECT L1 & L2 TO  
A CIRCUIT AT MORE THAN  
150 VOLTS TO GROUND

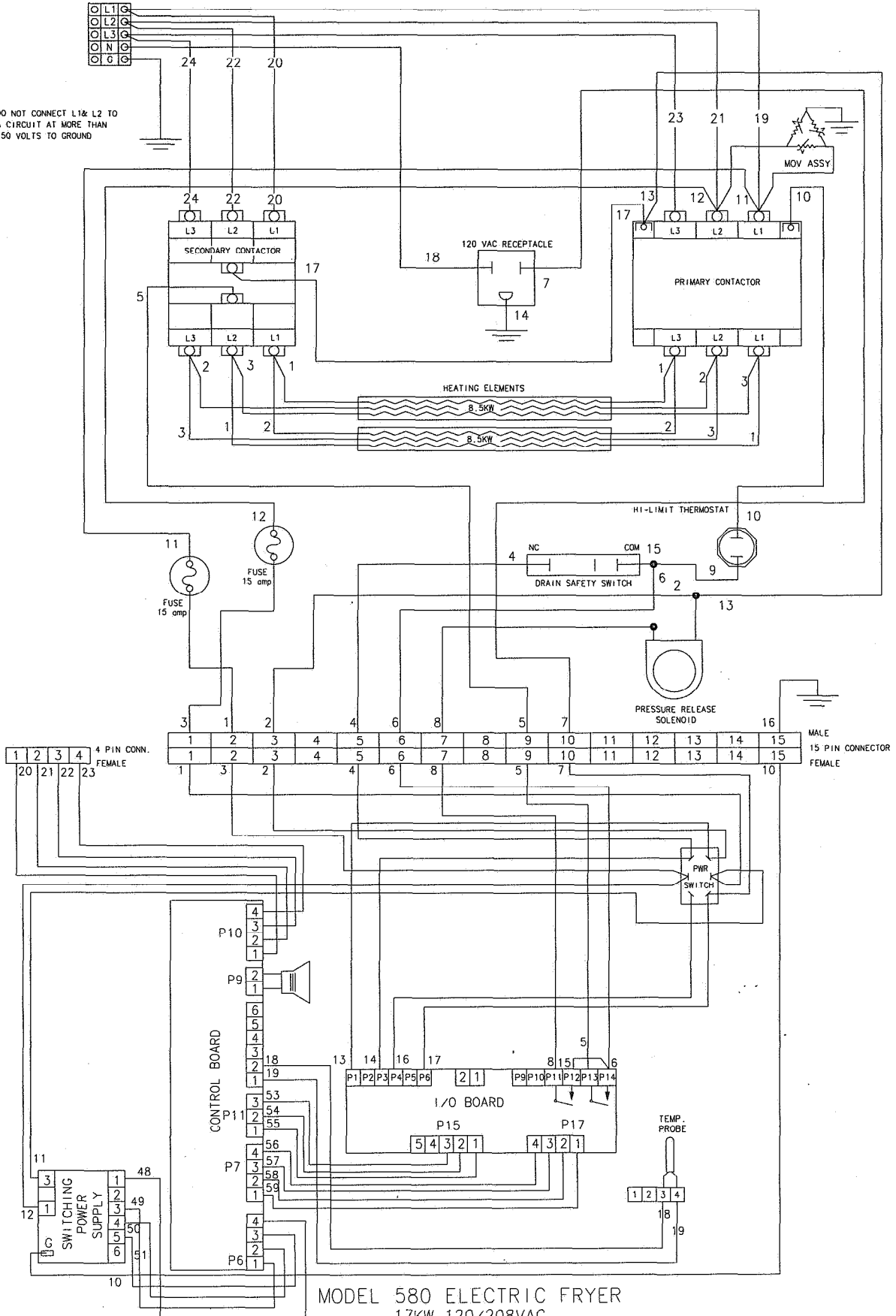

MODEL 580 ELECTRIC FRYER  
17KW 120/208VAC  
3PH 4WIRE W/GRND

NOTE: FOR SUPPLY CONNECTIONS  
USE COPPER STRANDED WIRE

DO NOT CONNECT L1 & L2 TO  
A CIRCUIT AT MORE THAN  
150 VOLTS TO GROUND

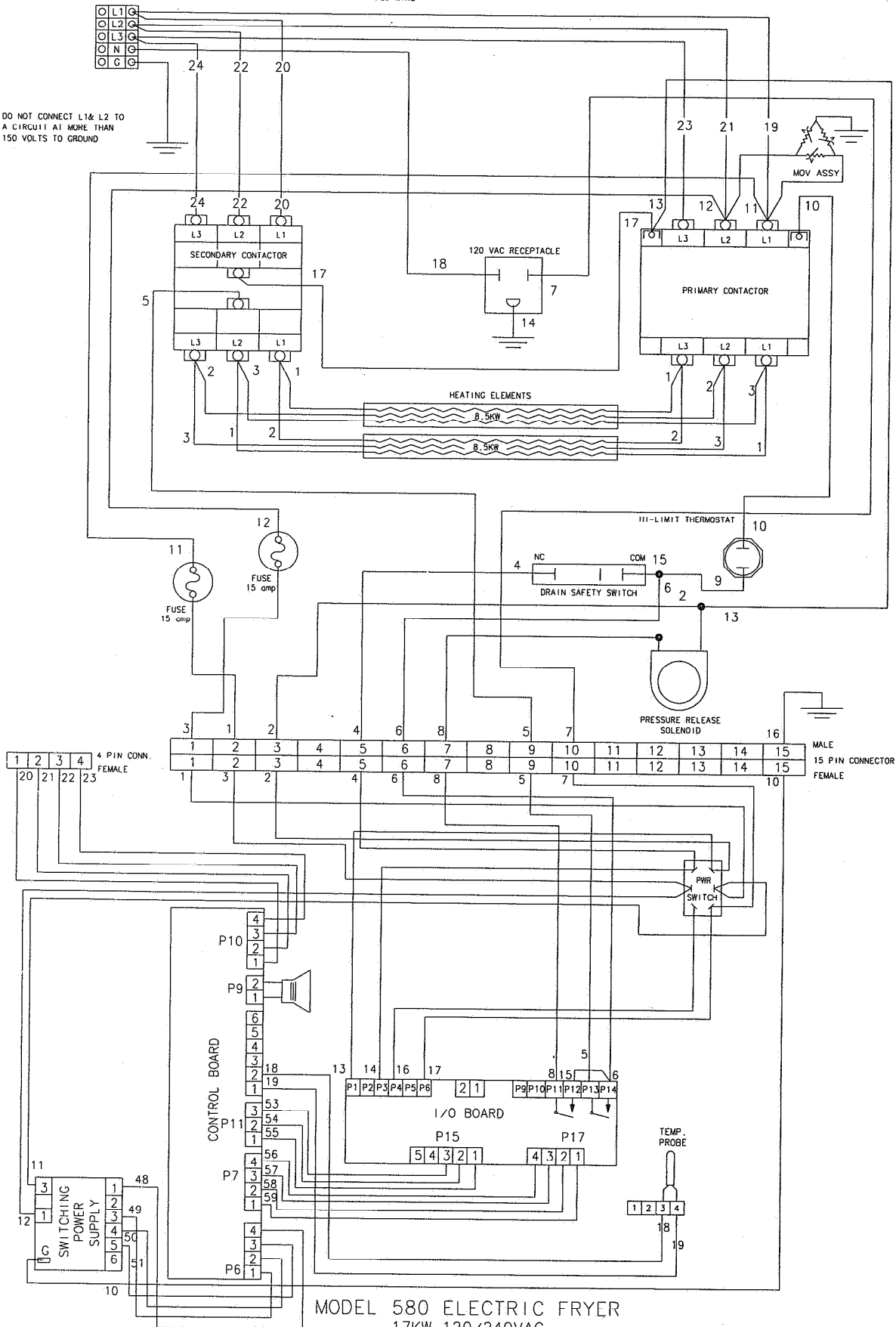

MODEL 580 ELECTRIC FRYER  
17KW 120/240VAC  
3PH 4WIRE W/GRND

NOTE: FOR SUPPLY CONNECTIONS  
USE COPPER STRANDED WIRE

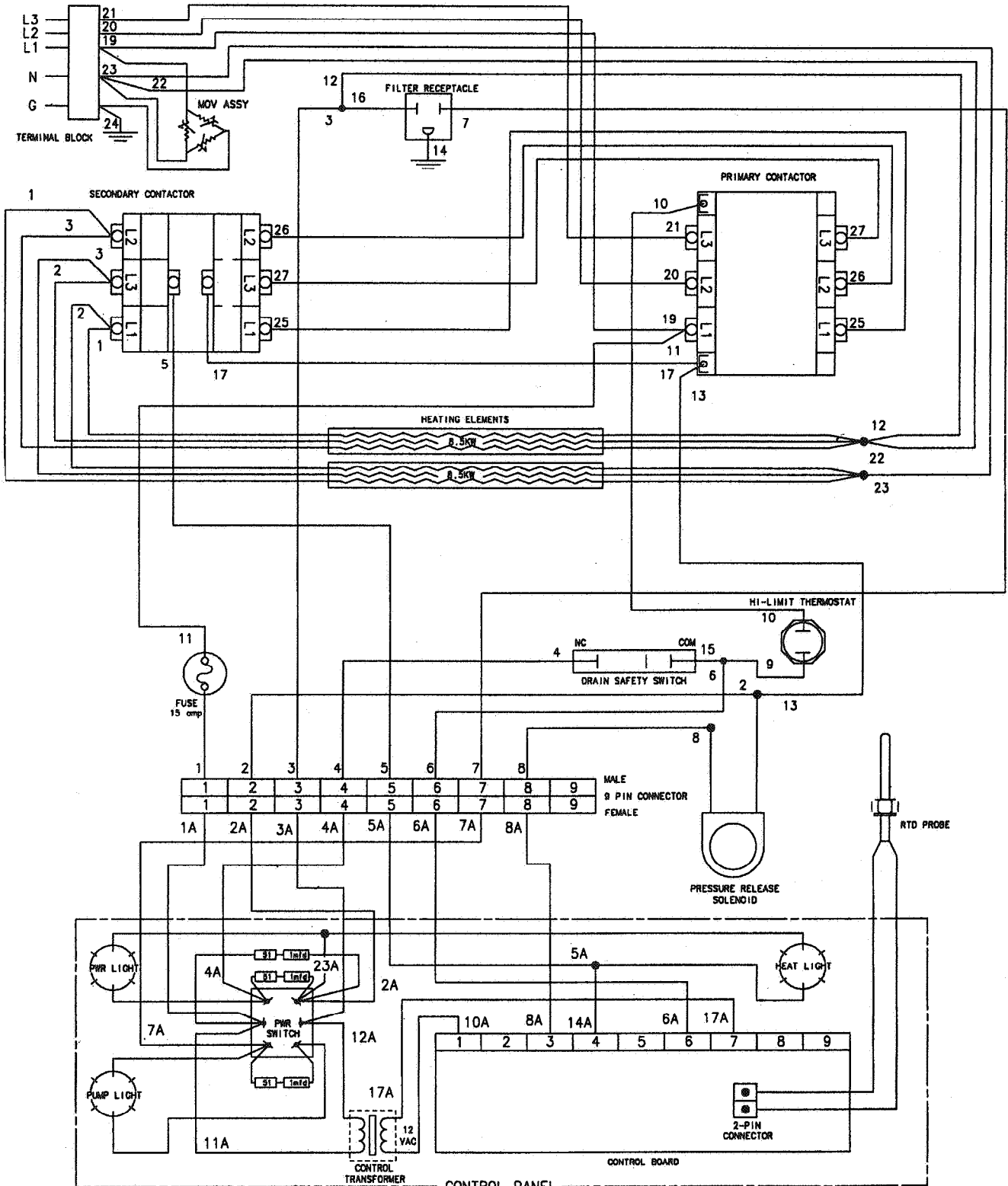

POWER	TRANSFORMER TAP
380	208V
415	240V

CONTROL PANEL  
**MODEL 580 ELECTRIC FRYER**  
 380VAC 3PH 50Hz 4W +GRND  
 OR  
 415VAC 3PH 50Hz 4W +GRND

35775

NOTE: FOR SUPPLY CONNECTIONS  
USE COPPER STRANDED WIRE

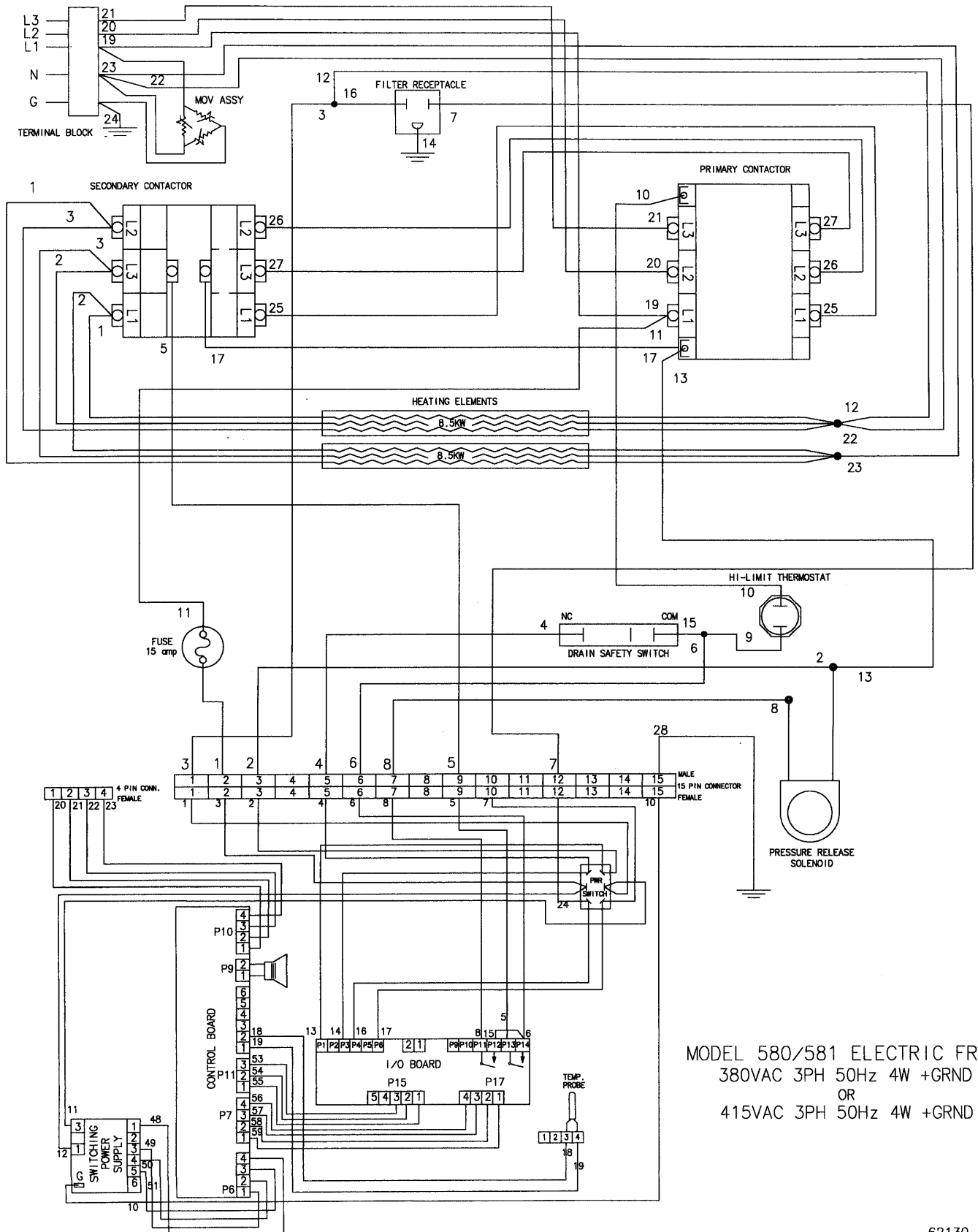

MODEL 580/581 ELECTRIC FRY  
380VAC 3PH 50Hz 4W +GRND  
OR  
415VAC 3PH 50Hz 4W +GRND

NOTE: FOR SUPPLY CONNECTIONS  
USE COPPER STRANDED WIRE

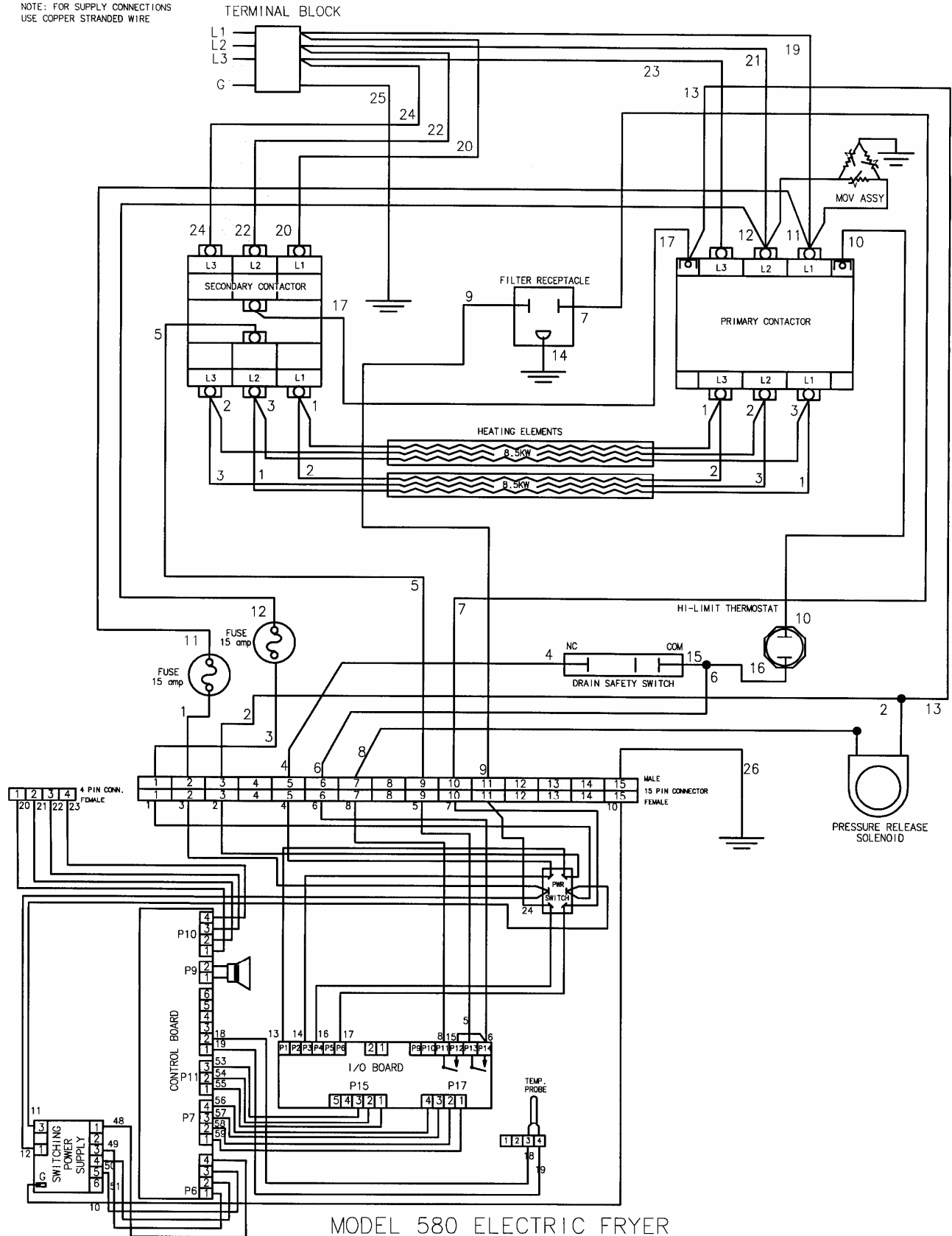

MODEL 580 ELECTRIC FRYER  
200VAC 3PH 50Hz 3W +GRND

62124

NOTE: FOR SUPPLY CONNECTIONS  
USE COPPER STRANDED WIRE

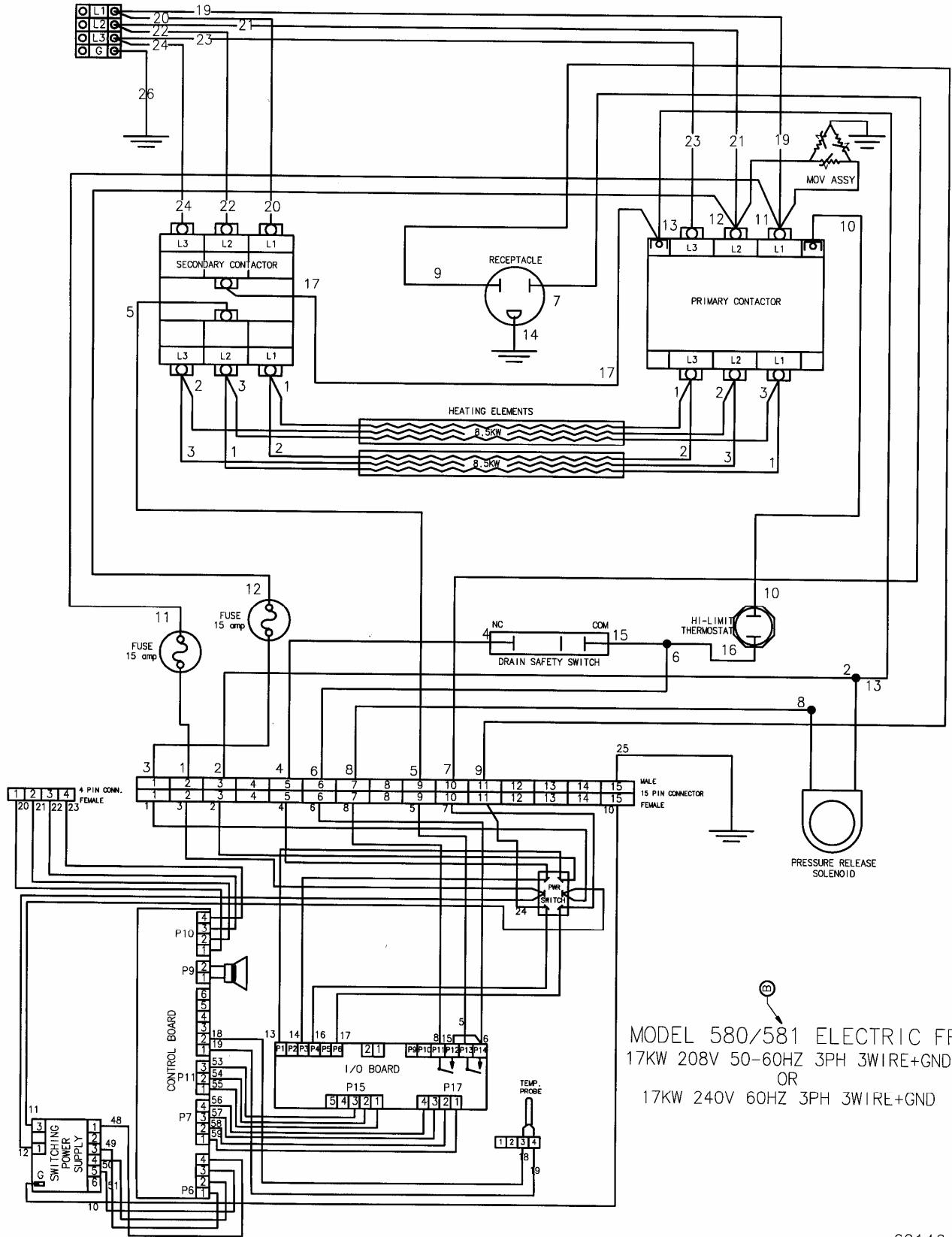

MODEL 580/581 ELECTRIC FR  
17KW 208V 50-60HZ 3PH 3WIRE+GND  
OR  
17KW 240V 60HZ 3PH 3WIRE+GND

62146

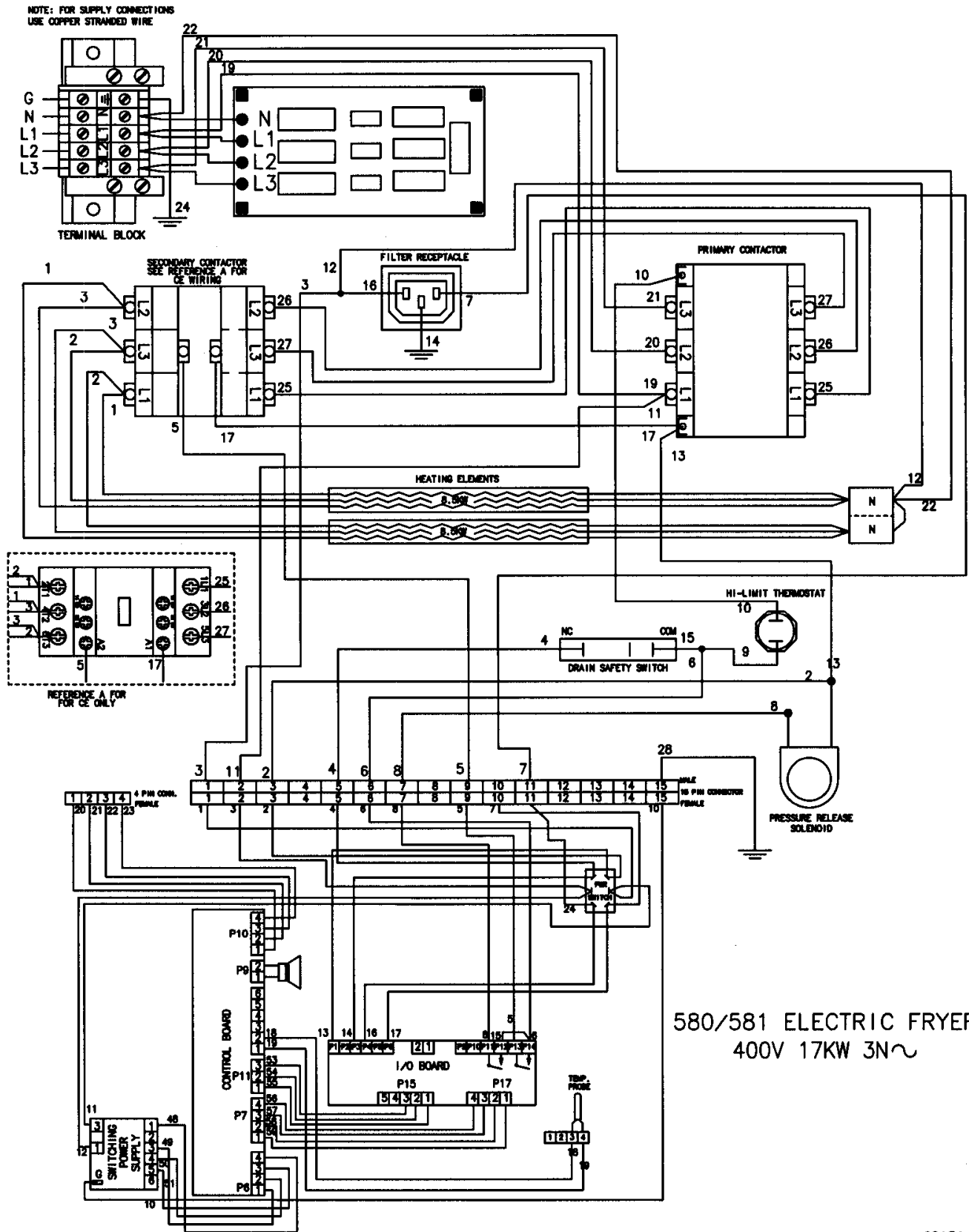

62131

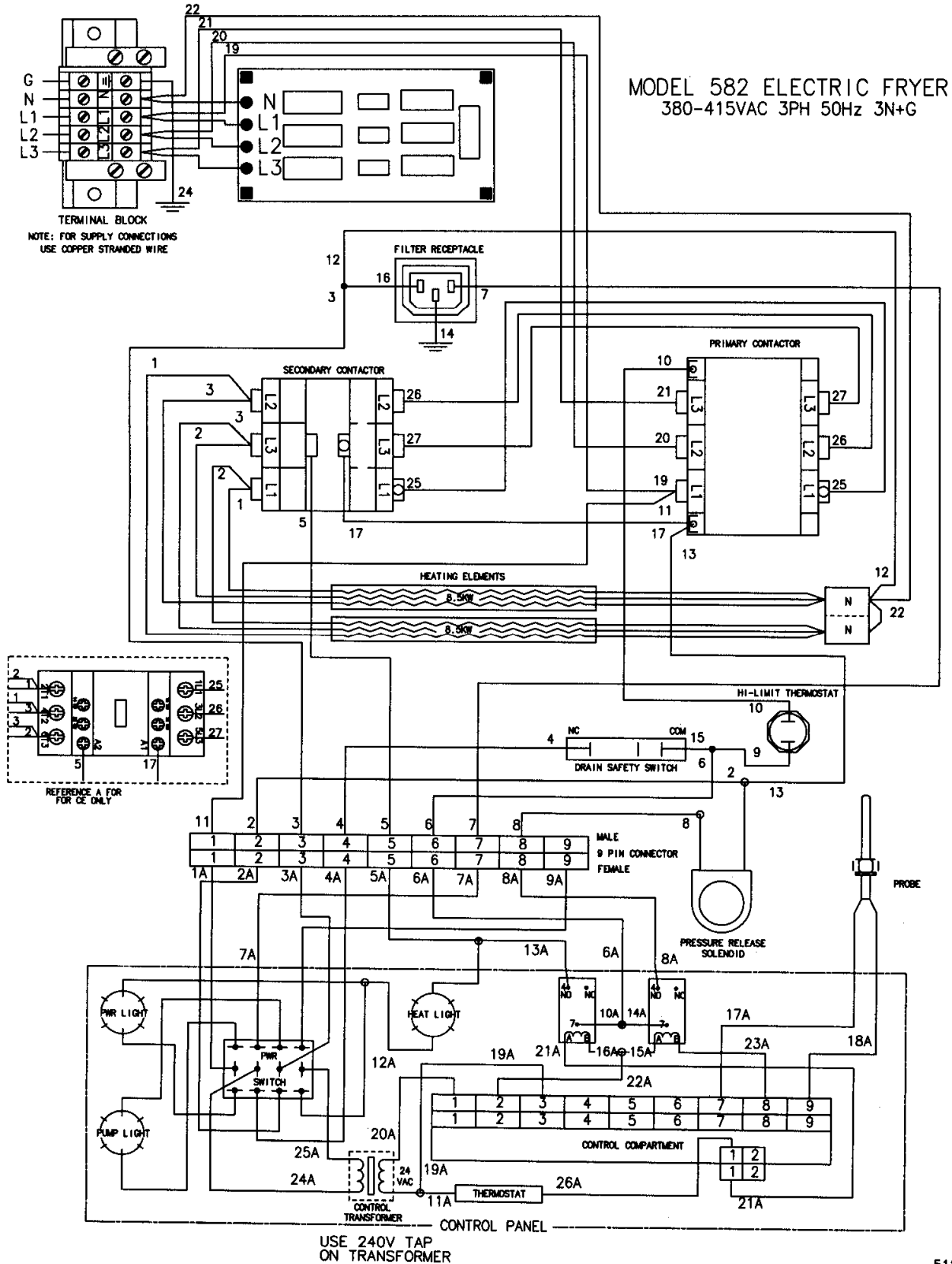

51201

**SMS PROGRAMMING  
(If Applicable)**

1. Press and hold the Function button for two seconds. “REG PROGRAM” will show in the display, followed by “CODE”.
2. Press the code 1,2,3. “SELECT PRODUCT” will scroll across the display.

**NOTE**

If no buttons are pressed, within approximately 1 minute while in the program mode, the controls will revert back to the cook mode.

3. Press the appropriate product button (1-0) to identify what product you want to program.
4. “INT1” and “TIME” will flash on the left side of the display. The right side will show the starting time of the cook cycle and can be changed by pressing the appropriate numbers. Ex: Press 1,0,0,0 and 10:00 will flash on the right side of the display, setting the start time at minutes.
5. After the time is set, press and release the Function button and “INT1” and “TEMP” will flash on the left side of the display. The right side will show the starting temperature and can be changed by pressing the appropriate numbers. Ex: Press 2,5,0 and “250° F” will show on the right side of the display, setting the start temperature at 250° Fahrenheit.
6. After the temperature is set, press and release the Function button and “INT1” and “PRESS” will flash on the left side of the display. Press any of the product buttons, (1-0), to turn the pressure on or off.
7. After the pressure is set, press and release the Function button and “INT1”, “LOAD”, and “COMP.” will flash on the left side of the display. The factory preset load compensation value shows in the right side of the display.

**SMS PROGRAMMING**  
**(Continued)**

8. After the load compensation, press and release the Function button. "PROP" and "CONTROL" shows on the left side of the display and the factory preset proportional control temperature shows on the right side of the display.
9. After the proportional control, press and release the Function button. "ALM 1" and "TIME" flashes in the left side of the display, and the first alarm time shows on the right side of the display. To change the time the alarm sounds, press the appropriate product buttons to set the time. Ex: Press 1,0,0,0. 10:00 will flash on the right side of the display, which means when the timer counts down to 10 minutes, an alarm will sound.
10. After alarm is set, press and release the Function button. "ALM 1", "SELF-", and "CANCEL" flashes in the left side of the display and "YES" or "NO" shows on the right side of the display. The yes and no can be toggled by pressing any of the product buttons, (1 -0). "YES" means the alarm tone will automatically stop after several beeps. "NO" means someone must manually press the appropriate product button to stop the alarm tone.
11. Repeat steps 9 and 10 for alarms 2 and 3.
12. After alarm 3 is set, press and release the Function button. "FILTER" and "CYCLES" show on the left side of the display and the filter cycle value is on the right side of the display. The value is the number of cook cycles that must completed before the control signals the operator that the shortening needs filtered

**SMS PROGRAMMING  
(Continued)**

13. After the filter value is set, press and release the Function button. “EOC” and “EXIT” flashes on the left side of the display and “COOL” shows on the right side of the display. The end-of-cycle, (EOC), exit point can be set to COOL, SETP, or FITR, by pressing any of the product buttons (EOC). At the end of a cook cycle the controls can be set to return to COOL, the setpoint temperature, or to signal the operator to filter the shortening.
14. After the end-of-cycle point is set, press and release the Function button. “HEAD” and “COUNT” flashes on the left side of the display and a number shows on the right side of the display. The number on the right is the number of head of chicken to be cooked when that product button is pressed. The number can be changed by pressing the appropriate product button.

**NOTE**

Another product can be programmed while in the program mode by following these procedures:

Press and hold the SCAN button at any time while in the Program mode and the display will scroll “SELECT PRODUCT”. Then press any of the product buttons, (1-0), and now that product can be programmed.

15. To program second interval, press and release the SCAN button while in the Time Mode of the first mode. “INIT 2” and “TIME” will flash on the left side of the display. Then follow the steps above, starting with step 4.

**SMS SPECIAL PROGRAM  
MODE**

**Review Usage**

1. Press and hold the Function button for two seconds until “REG PROGRAM” shows in the display. As soon as “REG PROGRAM” shows in the display, press and release the Function button 1 time until “REVIEW USE” shows in the display.
2. “DAILY” shows in the display. Press any of the Product buttons to view the usage of that product. Press and hold the Function button to exit Special Program mode.

**SMS SPECIAL PROGRAM  
MODE (Continued)**

**Reset Usage**

1. Press and hold the Function button for two seconds until "REG PROGRAM" shows in the display. As soon as "REG PROGRAM" shows in the display, press and release the Function button 2 times until "RESET USE" shows in the display.
2. When "CODE" shows in the display, press 1-3-5. "DAILY" will show in the display, and press any of the Product buttons to reset them to 0.

**Factory Presets (F/C, Gas/Electric, Speaker Volume, Speaker Frequency, Codes, Initialize System)**

1. Press and hold the Function button for two seconds until "REG PROGRAM" shows in the display. As soon as "REG PROGRAM" shows in the display, press and release the Function button 3 times until "FAC PRESET" shows in the display.
2. When "CODE" shows on the display, enter 2957. "DEG" and "MODE" flashes in the display. Press any of the product buttons to toggle from °F to °C, vice versa.
3. Press and release the Function button and "TYPE" and "FRYR" flashes in the display. Press any of the product buttons to toggle from "GAS" to "ELEC", or vice versa.
4. Press and release the Function button twice, and "SPKR" and "VOL" flashes in the display. The volume can be changed from 01 to 10, 10 being the loudest.
5. Press and release the Function button 3 times, and "SPKR" and "FREQ" will flash in the display. The frequency can be set from 100 to 2000.
6. Press and release the Function button 10 times, and "INITIALIZE SYSTEM" scrolls across the display. Press and hold any of the Product buttons and the display will count down from 5. Once the display counts down, release the Product button, and the control will set factory preset parameters into the controls.

**NOTE**

Before attempting to change the other modes in the Factory Preset mode, please call Technical Service Department at Henny Penny. 1-800-417-8405.

**SMS SPECIAL PROGRAM  
MODE (Continued)**

**Tech I/O Mode**

1. Press and hold the Function button for two seconds until “REG PROGRAM” shows in the display. As soon as “REG PROGRAM” shows in the display, press and release the Function button 4 times until “TECH I-O” shows in the display.
2. When “CODE” shows in the display, press 2-4-6. “HEAT”, “PRESSURE”, and “PUMP” will show, alternately, in the display. Also, the LEDs over 1, 2 and 3 will flash alternately.
3. To test the heat circuit, press and hold the 1 button.
4. To test the pressure system, press and hold the 2 button.
5. To test the pump system, press and hold the 3 button.

**Appliance Test**

Press and hold the Function button for two seconds until “REG PROGRAM” shows in the display. As soon as “REG PROGRAM” shows in the display, press and release the Function button 5 times until “APPL TEST” shows in the display.

With the power switch on, the display will show “CURR=”, along with the time it took the unit to heat from 250° to 300° F (121° to 149° C). This is normally recorded from the initial heat up in the morning.

**Heat Control**

1. Press and hold the Function button for two seconds until “REG PROGRAM” shows in the display. As soon as “REG PROGRAM” shows in the display, press and release the Function button 6 times until “HEAT CNTRL” shows in the display.
2. When “CODE” shows in the display, press 1-2-3-4. “MELT”, “EXIT”, and “TEMP” will flash in the display, along with the shortening temperature at which the unit will exit the melt cycle. This should be set at 180° F (82° C), and should not be changed until the factory is consulted.

**SMS SPECIAL PROGRAM  
MODE (Continued)**

3. Press and release the Function button and "MELT", "CYCLE", and "100s" shows alternately in the display, along with the period (pulse) length of 4000. This should not be changed until the factory is consulted.
4. Press and release the Function button twice and "MELT", "ON-", "TIME", and "100s", shows alternately in the display, along with the length of time the heat is on. This should be set at 1700, and should not be changed until the factory is consulted.
5. Press and release the Function button three times and "COOL", "SET-", and "POINT" shows alternately in the display, along with the temperature at which the control exits the melt cycle. This is set at 250° F (121° C), and should not be changed until the factory is consulted.
6. Press and release the Function button four times and "AUTO", and "IDLE" shows alternately in the display, along with "OFF". This should not be changed until the factory is consulted.
7. Press and release the Function button five times and "AUTO", "IDLE", and "MMSS" shows alternately in the display, along with "0:00". This should not be changed until the factory is consulted.
8. The last 3 functions in the Heat Control mode are used by the factory only, and should not be changed.