

# Hickory Rotisseries

Models: N/5.5 E



Machine Type	N / 5. 5 E
Total Power Rating	6000 or 8400 Watts
Elements / Spits	4 Elements with 5 Spits
Electrical Rating	208/240 V or 380/410 V
Temperature Range	200°F - 550°F
Timer	Manual or Fully Automatic
Delivery Date:	Final Inspection:

---

**Table of Contents**

<b>1.0 Installation Instructions</b>	<b>3</b>
1.1 General Information	4
1.2 Description of the Data Plate	4
1.3 Machine Drawings and Dimensions	6
1.4 Electrical Conversion and Adjustment Instructions	7
1.5 Cooking Cycle	7
1.6 Maintenance, Response to Technical Problems	7
1.6.1 Reasons for Problems and Solutions	8
1.7 Spit Drive Mechanism	9
1.8 N/5.5E Parts List	10
1.9 N/5.5E Exploded View	12

## **1.0 Installation Instructions**

- a. When installing these units, it is important to comply with the most recently established rules and regulations as deemed pertinent by the local and national electrical, ventilation, sanitation, and fire codes. These units are classified by Underwriters Laboratories, Inc. as Electrically Heated Food Service Equipment.
- b. Electric units must not be directly connected to a flue or exhaust vent. However, electric units may require operation in conjunction with a canopy type exhaust hood if deemed necessary by local authorities.
- c. The units must be installed in such a way that proper ventilation and heat exchange is assured. The room must be ventilated in accordance to the valid codes and regulations.
- d. The units are to be installed securely and horizontally. The units may be installed on combustible floors. The units must be installed with adjustable legs if placed on a combustible surface.
- e. The minimum clearance to the rear or side walls must be 13 inches. It is also important to insure that the bottom of the units is kept clear so that proper ventilation or air exchange can occur. Rear clearance can be reduced to 1" with the replacement of the rear glass with metal panels.
- f. Normally, the units will be sent to the operator already set up for the particular electrical service available at their location. However, unless otherwise specified, the electric units are set up for 208 V, 3 Phase, 60 Hz use. Before installing and using the units for the first time, it is important to make sure that the electrical power indicated on the data plate matches the type of electrical power available in the location. Should this not be the case, it is imperative to change or convert the units to the needed types.
- g. Electric units must be hard-wired or fitted with a power cord by a licensed electrician.

**1.1 General Information**



The Operating Instructions are to be given to the operator of the rotisserie. All unit operators are to be familiar with the functions of the rotisserie.



The Operating Instructions should be kept in a location close to the rotisserie. It should be easily recognizeable and easily accessible.

Electric units can be ordered to meet most electrical specifications.

It is recommended that a repair and maintenance contract be signed with the manufacturer's agent, distributor, or service agency.

**1.2 Description of the Data Plate**

<b>HICKORY INDUSTRIES, INC.</b> NORTH BERGEN, NJ 07047		
MODEL: <input type="text" value="N/5.5 E"/>	M	SERIAL NO. <input type="text"/>
MOTOR: 110 - 120 VOLTS 60 CYCLE AC		
CURRENT		
WATTS	SINGLE PHASE	3 RPM
HEATING ELEMENTS LISTED	208 VOLTS	PHASE AC 60 CYCLE
	CURRENT	
	<input type="text" value="4"/>	<input type="text" value="1400"/>
	WATTS PER ELEMENT	
	TOTAL WATTAGE	<input type="text" value="6000"/>
MFG. DATE	<input type="text"/>	
MINIMUM INSTALLATION CLEARANCES		
	SIDES:	13 INCHES
	BACK:	13 INCHES
MAXIMUM WATTAGE PER LAMP 40 WATTS		

<b>HICKORY INDUSTRIES, INC.</b> NORTH BERGEN, NJ 07047		
MODEL: <input type="text" value="N/5.5 E"/>	M	SERIAL NO. <input type="text"/>
MOTOR: 110 - 120 VOLTS 60 CYCLE AC		
CURRENT		
WATTS	SINGLE PHASE	3 RPM
HEATING ELEMENTS LISTED	208 VOLTS	PHASE AC 60 CYCLE
	CURRENT	
	<input type="text" value="4"/>	<input type="text" value="1400"/>
	WATTS PER ELEMENT	
	TOTAL WATTAGE	<input type="text" value="6000"/>
MFG. DATE	<input type="text"/>	
MINIMUM INSTALLATION CLEARANCES		
	SIDES:	13 INCHES
	BACK:	13 INCHES
MAXIMUM WATTAGE PER LAMP 40 WATTS		

**WARNING!**

**This unit must be installed and connected in accordance to the latest regulations and may require operation in conjunction with a forced ventilation or exhaust hood.**

**This unit has been designed for professional use only and may only be installed or repaired by licensed service agencies!**

**Before installing or using this equipment, read these instructions!**



**HICKORY INDUSTRIES, INC.**  
NORTH BERGEN, NJ 07047

MODEL:  M SERIAL NO.

MOTOR: 208 - 220 VOLTS 60 CYCLE AC CURRENT  
WATTS SINGLEPHASE 3 RPM

HEATING ELEMENTS 208 VOLTS 60 CYCLE

LISTED 3 PHASE AC  
CURRENT

   1400 WATTS PER ELEMENT

TOTAL WATTAGE

MFG. DATE

MINIMUM INSTALLATION CLEARANCES  
SIDES: 13 INCHES  
BACK: 13 INCHES  
MAXIMUM WATTAGE PER LAMP 40 WATTS



**HICKORY INDUSTRIES, INC.**  
NORTH BERGEN, NJ 07047

MODEL:  M SERIAL NO.

MOTOR: 110 - 120 VOLTS 60 CYCLE AC CURRENT  
WATTS SINGLEPHASE 3 RPM

HEATING ELEMENTS 208 VOLTS 60 CYCLE

LISTED 3 PHASE AC  
CURRENT

   2000 WATTS PER ELEMENT

TOTAL WATTAGE

MFG. DATE

MINIMUM INSTALLATION CLEARANCES  
SIDES: 13 INCHES  
BACK: 13 INCHES  
MAXIMUM WATTAGE PER LAMP 40 WATTS



**HICKORY INDUSTRIES, INC.**  
NORTH BERGEN, NJ 07047

MODEL:  M SERIAL NO.

MOTOR: 208 - 240 VOLTS 50 CYCLE AC CURRENT  
WATTS SINGLEPHASE 3 RPM

HEATING ELEMENTS 208 VOLTS 50 CYCLE

LISTED 1 PHASE AC  
CURRENT

   1400 WATTS PER ELEMENT

TOTAL WATTAGE

MFG. DATE

MINIMUM INSTALLATION CLEARANCES  
SIDES: 13 INCHES  
BACK: 13 INCHES  
MAXIMUM WATTAGE PER LAMP 40 WATTS



**HICKORY INDUSTRIES, INC.**  
NORTH BERGEN, NJ 07047

MODEL:  M SERIAL NO.

MOTOR: 208 - 240 VOLTS 50 CYCLE AC CURRENT  
WATTS SINGLEPHASE 3 RPM

HEATING ELEMENTS 208 VOLTS 50 CYCLE

LISTED 3 PHASE AC  
CURRENT

   1400 WATTS PER ELEMENT

TOTAL WATTAGE

MFG. DATE

MINIMUM INSTALLATION CLEARANCES  
SIDES: 13 INCHES  
BACK: 13 INCHES  
MAXIMUM WATTAGE PER LAMP 40 WATTS



**HICKORY INDUSTRIES, INC.**  
NORTH BERGEN, NJ 07047

MODEL:  M SERIAL NO.

MOTOR: 208 - 240 VOLTS 50 CYCLE AC CURRENT  
WATTS SINGLEPHASE 3 RPM

HEATING ELEMENTS 208 VOLTS 50 CYCLE

LISTED 3 PHASE AC  
CURRENT

   2000 WATTS PER ELEMENT

TOTAL WATTAGE

MFG. DATE

MINIMUM INSTALLATION CLEARANCES  
SIDES: 13 INCHES  
BACK: 13 INCHES  
MAXIMUM WATTAGE PER LAMP 40 WATTS

1.3 Machine Drawings and Dimensions

The following drawing of the Front View, Side View, and Top View indicate where the dimensions are taken and should be used to plan the installation of the units.

N/ 5.5 E

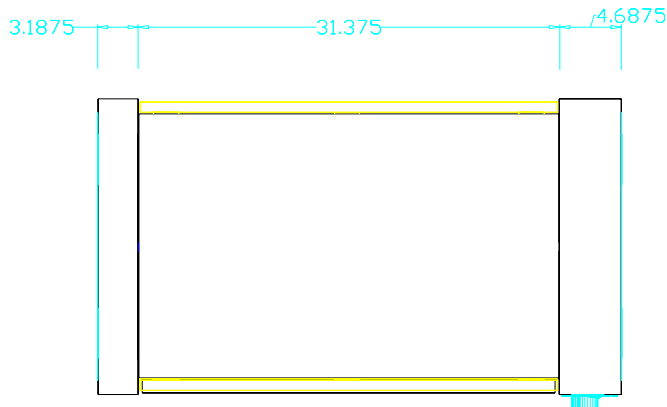

Top View

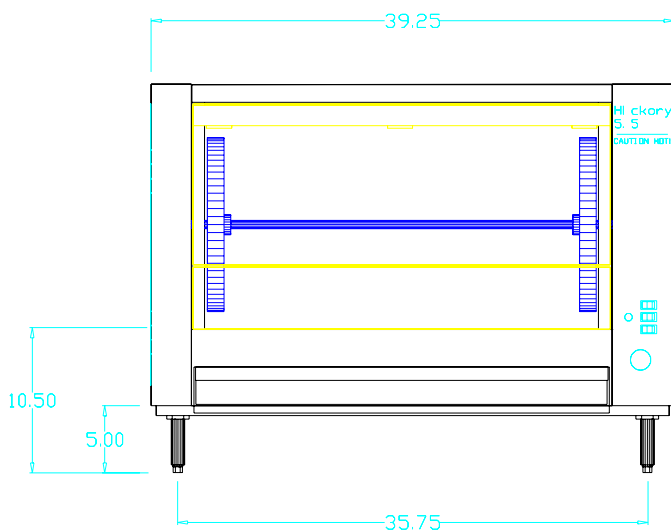

Front View

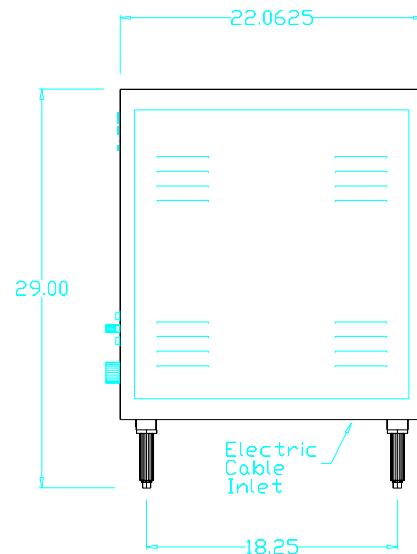

Right Side View

N/ 5.5 E	inches	mm
Height	29"	737
Width	39-1/4"	997
Depth	22-1/16"	560

#### **1.4 Electrical Conversion and Adjustment Instructions**

Before converting or adjusting the machine to another type of electricity, it is imperative that electrical power to the machines should also be turned off. When converting, make sure that the proper electrical diagram is followed and that the motor and timer match the connected single phase voltage!

#### **1.5 Cooking Cycle**

In order to start the cooking cycle, the elements must be powered. The heating cycle will start only when the following procedure is followed:

- a. The TEMPERATURE switch is turned to "on".
- b. A cooking temperature must be set on the thermostat (i.e. 450°F).
- c. The cooking timer must be activated (see Operating Instructions).

Once these steps are completed, the unit will call for heat and the cooking cycle will be activated. The main contactor, which powers the heating elements, will stay on until the set cooking temperature is reached, as sensed by the thermocouple attached to the thermostat. With the temperature reached, the electrical power to the elements will be cut off as the thermostat shuts off the power to the contactor. When the temperature drops below the set point, electrical power is again sent to the heating system, thus starting the heating process all over. The system will cycle on and off as needed to maintain the set cooking point.

#### **1.6 Maintenance, response to technical problems.**

Should a technical problem arise for any reason, shut off the machine and call for technical service.

A routine maintenance should be carried out at least once a year. Contact your local, certified service company for maintenance.

**1.6.1 Reasons for Problems and Solutions**

Problem	Cause	Solution
Unit does not heat.	a. Rotisserie not "on".	<ol style="list-style-type: none"> <li>1. Make sure that the TEMPERATURE switch is on.</li> <li>2. Thermostat must be set (i.e. 550°F). The cooking timer must be operational (cook cycle).</li> <li>3. A red LED on the TEMPERATURE switch indicates that the contactor is supplying power to the heating elements.</li> <li>4. Using the electrical diagram, make sure that the entire system is fully functional.</li> </ol>
Unit takes too long to cook.	<ol style="list-style-type: none"> <li>a. Temperature set too low.</li> <li>b. Timer is not properly set.</li> <li>c. Chicken are too big.</li> <li>d. Not enough power is being supplied to the unit.</li> <li>e. The lower metal deflectors are on backwards.</li> </ol>	<ol style="list-style-type: none"> <li>a. To cook chickens, we suggest that the temperature be set to MAXIMUM. If the chickens are "burning", which is usually due to sugars in the marinade or rub, then the temperature must be reduced accordingly.</li> <li>b. When programming the timer, it will only heat up the rotisserie when a "cook pot" appears on the display. Before setting a cooking time, make sure that enough time is programmed!</li> <li>c. A load of 20 chickens, each about 3.25 lbs., will take about 1 hour and 30 minutes to cook in a 6400 Watt unit. The larger the chickens, the longer the cooking time.</li> <li>d. Make sure that the hot, neutral, and ground leads are properly matched up. Also make sure that all of the phases are live.</li> <li>e. The two lower heating elements have two concave deflectors which direct the heat towards the center of the chamber. A common error is to cover the elements, preventing the heat from reaching the center of the unit.</li> </ol>

1.7 Spit Drive Mechanism

This unit is equipped with a planetary motion spit drive system. This means that each spit is turning upon its axis at the same time that they turn about the center shaft. When the motor switch is turned to on, the disks and the spits will begin to turn. Insure that the mechanism turns smoothly when testing the unit.

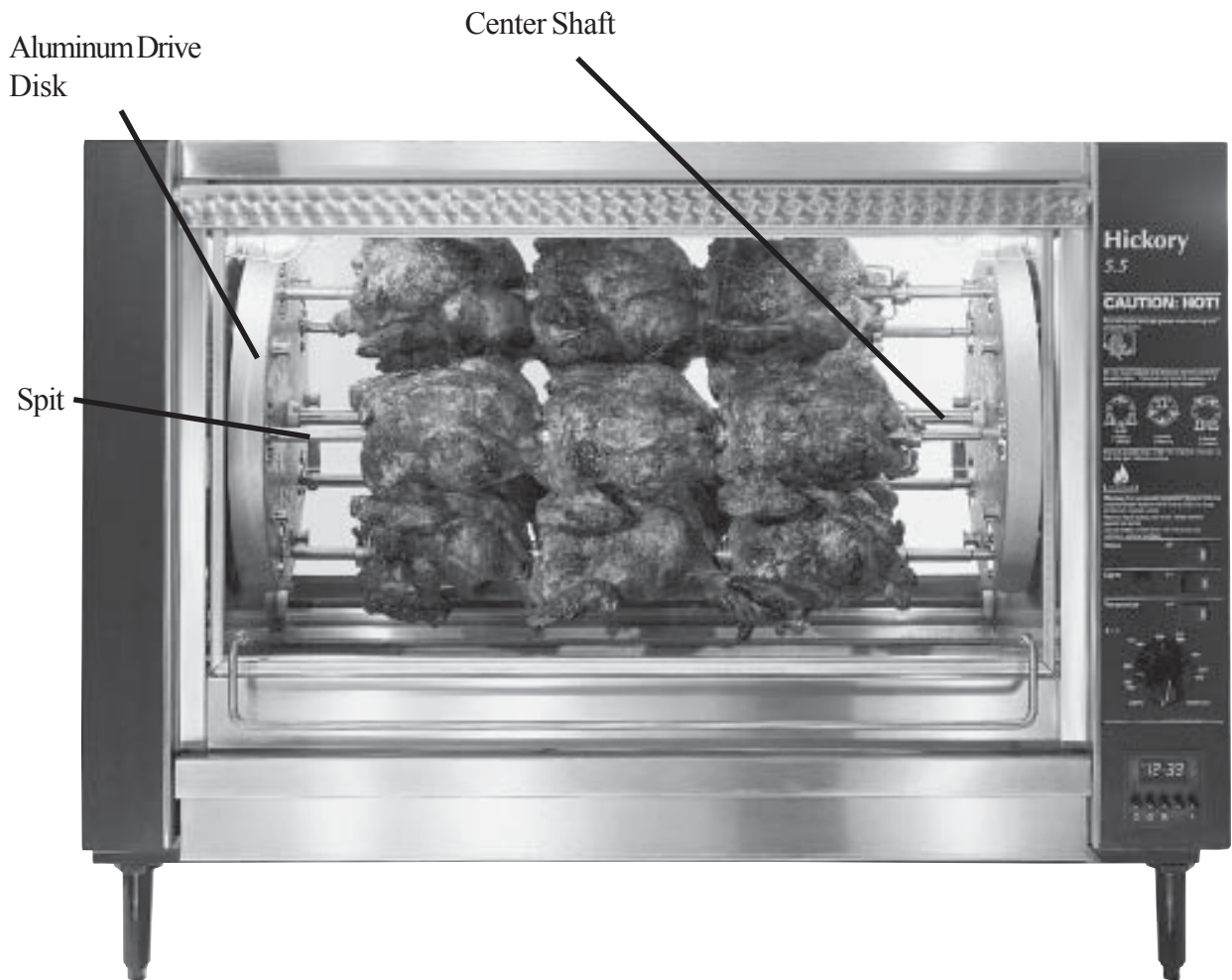

Before cooking, it is imperative that the center shaft be covered and protected with aluminum foil. This will prevent fats from carbonizing on the shaft, making the removal of the aluminum disks much easier in the future. If the shaft is not protected, it may eventually be impossible to remove the disks should there be a problem in the spit drive mechanism.

The driven and the stationary drive gears are located behind the aluminum drive disk. These can be viewed by taking out the removable aluminum disks. The driven gears and the stationary gear should be viewed once a week to check for fat or carbonization build-up. Any fat or dirt should be cleaned off since a build-up will eventually damage the drive system.

## 1.8 N/5.5E Parts List

Item	Qty.	Description	Material	Length	Size	Manufacturer
553	1	Shaft 5/8 (Removable Drums - Center)	SS		5/8"	Hickory
554	1	Shaft Locking Slide	SS			Hickory
519	1	Drive Bearing Holder (Left - with brass bearing)	Steel (Chromed)			Hickory
520	1	Drive Bearing Holder (Right - with teflon bearing)	Steel (Chromed)			Hickory
	1	Brass Shaft Bearing	Brass			Hickory
566	1	Teflon Shaft Bearing	Teflon			Hickory
501	1	Aluminum Disk Drive (Bare)	Cast Aluminum			Hickory
502	1	Aluminum Disk Slave (Bare)	Cast Aluminum			Hickory
503	1	Alum. Disk Drv. (Complete w/ Spit Driven Gears)				Hickory
504	1	Alum. Disk Slave (Complete w/ Spit Supports)				Hickory
514	1	Disk Retaining Pin	Steel	1-1/2"	5/32"	Hickory
564	5	Teflon Spacers - 1/4" round				Hickory
505		Aluminum Disk Teflon Coating				Hickory
561	5	Spit Driven Gear Assembly	Steel (Chromed)			Hickory
555	5	Snap Ring (Gears)	Steel			Hickory
559	5	Spit Driven Gear Bearing Holder	Steel (Chromed)			Hickory
560	5	Spit Driven Gear	Steel (Chromed)			Hickory
565	5	Teflon Spit Driven Gear Bearing			1/4"	Hickory
563	1	Stationary Gear	Steel			Hickory
562	5	Spit Support	Steel (Chromed)			Hickory
510	1	Chain (Roller - 5.5)	Steel			Hickory
511	1	Chain Link (Roller - 5.5)	Steel			Hickory
521	1	Drive Sprocket - Roller Chain	Steel			Hickory
522	1	Driven Sprocket - Roller Chain	Steel			Hickory
	1	Drive Shaft				
512	1	Chain Tensioner	Steel			Hickory
509	1	Buss Fuse 0.5 Amp				Buss
527	1	Fuse Holder 0.5 Amp				
538	4	Lamp Cover	Steel (Chromed)			Hickory
541	3	Micro Switch & Toggle				Marquardt
567	1	Thermostat 200-550				
568	1	Thermostat Knob				
569	1	Timer (without Adapter)				Eaton
569a	1	Adapter (for Timer)				Eaton
542	1	Motor Gear - 120V				Bodine
539	1	Lamp, 120 V				Hickory
540	4	Lamp Socket	Ceramic			Leviton
120	1	Drip Pan (5.5)	SS			Hickory
121	1	Drip Pan Plug	Brass			Hickory
122	1	Drip Pan Receptacle	Brass			Hickory

1.8 N/5.5E Parts List (Contd.)

Item	Qty.	Description	Material	Length	Size	Manufacturer
123	1	Electrical Grounding Cap				Hickory
		Electrical Wire				Janor Wire
106	1	Buchanan Contact Section 824				Buchanan
107	1	Buchanan Contact Section 830				Buchanan
550	1	Relay (Contactor) 3 Pole 220V				GE
	1	Capacitor				GE
525	8	Element Holder				Hickory
129	4	Element Porcelain Insulator				Hickory
523	4	Element, Straight 220 V - 1400 Watt				Glenn
524	4	Element, Straight 240 V - 1400 Watt				Glenn
549	2	Reflector	SS			Hickory
513	2	Glass Hinge	SS			Hickory
515	2	Door Bearing Brass	Brass			Hickory
516	1	Door Handle (Metal)	Steel			Hickory
518	1	Door Spring (Mechanical)	Steel			Hickory
545	1	Pneumatic Spring				
532	1	Glass Tempered Large (Door)	Glass		28.94" x 16.5"	Hickory
533	1	Glass Tempered (Rear)	Glass		28.94" x 12"	Hickory
534	1	Glass Tempered (Rear - Small)	Glass		28.94" x 4.5"	Hickory
526	4	Feet Adjustable Plastic	Plastic			Hickory
556	5	Spit Complete (incl. all skewers & screws)	SS			Hickory
185	5/Spit	Skewer Double	SS			Hickory
186	5/Spit	Skewer Single	SS			Hickory
219	1/Skw.	Thumb Screw	Steel			Hickory
557	1	Spit Turkey Center only	SS			Hickory
225	2	Turkey Skewers Single	SS			Hickory
506	5	Basket Hanging	Steel (Chromed)			Hickory
507	5	Basket Bearing Brass	Brass			Hickory
439a		Angle (V) Spits (Option!)	SS			Hickory
508		Basket Spits (	Steel (Chromed)			Hickory



## Glass Replacement on the 5.5E & 10.10E Machines

Make sure that the handle and all associated hardware is available at the site or order the mounting kit from Hickory.

**Make sure that the glass bar is in the open position.**



Closed Position

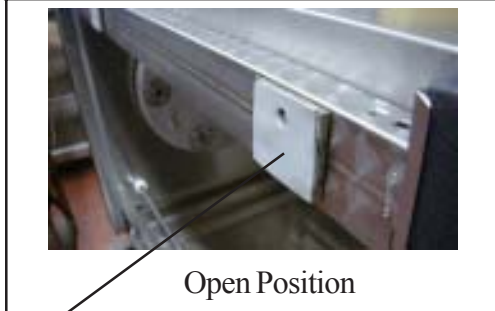

Open Position

**Newer style units incorporate the spacer welded on the glass bar..**

### Upper mounting hardware

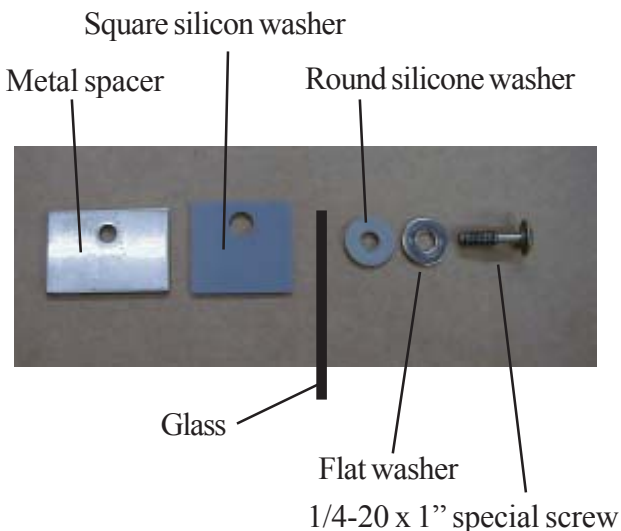

Make sure that the handle and all associated hardware is available at the site or order the mounting hardware from Hickory.

Glass handle, flat washer, lock washer, 10/32 screw

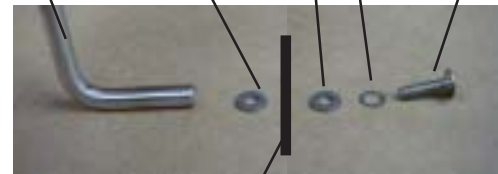

Glass

The glass mounts between the glass handle and the flat washer.

Install the glass handle. Be sure to use Loc-Tite.

Glass Frame

Glass Handle



**NOTE: THE 90 BEND ON THE GLASS HANDLE IS LOWER THAN THE GLASS. DO NOT MOUNT THE HANDLE WITH THE 90 DEGREE BEND UP.**

**USE HIGH TEMPERATURE LOC-TITE on all screws for both the glass handle and the upper mounting screws.**

**Otherwise the handle will come loose and chip the glass or fall slightly and chip around the mounting screw holes. This will lead to breakage!**

**Replacing the front glass**

Insert the screw on to the glass (use hi heat Loc-tite). As a hint, start with the middle screw it will give you some leverage with the glass.



Slowly turn the screw onto the glass bar - **DO NOT TIGHTEN**. Make sure that you do not see any threads or that the glass rests on the threads.

**Make sure that when resting the glass on the screws, it only rests on the un-threaded portion of the screw (closest to the head of the screw).**

Before moving glass make sure threads are inserted onto metal spacer



**Threads Exposed**

**DO NOT TIGHTEN.** This will ensure that you have enough play to move the glass around without bumping the glass.

Proceed with the remaining screws (use hi heat Loc-tite). Make sure that the glass is sandwiched between silicone washer and the silicone spacer.

Silicone Washer

Silicone Spacer



Slightly turn each screw until snug. It should be snug but loose enough to move. Adjust the glass so that the spacing is even around the sides and bottom of the machine. You can now verify the glass spacing with the side and the bottom of the machine.

**Improperly Spaced**

**Note:  
Uneven  
Spacing**

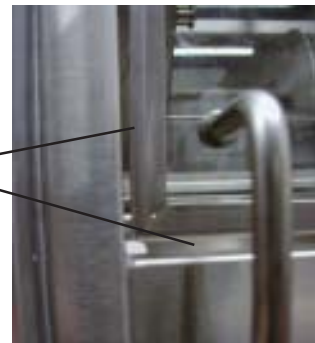

**Properly Spaced**

**Note:  
Even  
Spacing**

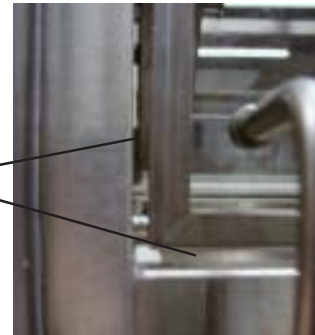

If the glass is not evenly spaced, adjust the glass until its evenly spaced.

**CAUTION:** If the screws are not snug enough, when lowering the glass door, the glass may hit the screws and chip the glass.

**CAUTION:** When tightening the screws, if the glass shifts down, the glass door will be too close to the roof of the machine when the glass door is shut.

Open door and tighten upper mounting screws.

Close the door and verify that the side and bottom spacing is even all around.

Make sure all screws are tight and have been replaced using hi **heat Loc-Tite**.

Return equipment back to operating condition.

## Caution

**Operators should not use a razor blade or knife to clean the glass.**

**Glass should not be cleaned with abrasives, soft scrub or any pad, i.e. Brillo, Scotch Brite, scouring pad etc. This will scratch the glass and render the glass faulty.**

**Tempered glass will break if scratched, shipped or mishandled in any way. It can break in a day or a year. BUT IT WILL BREAK.**