

Hickory Rotisseries

Model: N/6.5G & N/7.5 G



(7.5G Shown)



Voltage: 120V single phase, Amps: 3, Hz: 60

Cooking burners: 1 Pressurized burner

	6.5G	7.5G
BTU's / Cooking Burner: Natural	42,000	99,000
Propane	40,000	98,000

Manifold Pressure: 5.5 in W.C. Natural
11 in W.C. Propane

Minimum Installation Clearance:
3 Inches sides and back. 15 inches rear with glass door in back

Lamps should be replaced with 120V, 40W rated bulbs or equivalent

Specifications and manual subject to change without notice

Table of Contents

Installation Instructions	3
Unpacking The Unit	4
Setting Up The Rotisserie	4
General Information	5
Machine Drawings and Dimensions	6
Spit Preparation Using Angle Spits	7
Spit Preparation Using Spits & Skewers	12
Daily Operation	17
Cleaning	17
Thermometer Guidelines	18
Temperature Chart	19
Do's and Don'ts	20
Parts Diagram	21
Electrical Diagram	22
Warranty	23

Installation Instructions

- a. When installing these units, it is important to comply with the most recently established rules and regulations as deemed pertinent by the local and national electrical, gas, ventilation, sanitation, and fire codes. These units are classified by Underwriters Laboratories, Inc. as Gas-Fired Food Service Equipment in accordance with American National Standards Institute ANSI Z83.11b-1991, Gas Food Service Equipment - Ranges and Unit Boilers.
- b. These gas units may not be directly connected to a gas flue or exhaust. However, the units may only be operated in conjunction with a canopy type exhaust hood.
- c. The room where the units are being installed must be ventilated in accordance to the valid codes and regulations.
- d. The units are to be installed securely and horizontally. The units may be installed on combustible floors.
- e. The minimum clearance to the rear or side walls must be 3 inches. It is also important to insure that the bottom of the units is kept clear so that proper ventilation or air exchange can occur.
- f. Normally, the units will be sent to the operator already set up for the particular type of gas available at their location. However, unless otherwise specified, the units will be set up for natural gas use. Before installing and using the units for the first time, it is important to make sure that the gas type and pressure indicated on the data plate matches the type of gas available in the location. Should this not be the case, it is imperative to change or convert the units to the needed gas type.
- g. The units must be fitted with the manual shut-off gas cock (valve) supplied with the machine. This manual valve is needed to shut off the gas to the machine during maintenance work, repairs, pressure testing and if the unit needs to be disconnected for any reason. **DO NOT REMOVE otherwise warranty will be voided.**
- h. A gas regulator is also supplied with the machine. This component is needed so that the appropriate gas pressure can be set and insure an optimum operation of the unit. **DO NOT REMOVE otherwise warranty will be voided.**
- i. When installing this unit with a gas quick disconnect, a tethering device must be used.
- j. Depending on local codes or if deemed necessary, a gas filter may also be required.
- k. Do not connect the unit to a 3/4" gas line. Connecting the unit to a lesser line can reduce the units effectiveness or cause improper operation.

l. After connecting the unit, make sure that the line has been bled and that a static pressure reading of at least 7" water column pressure is obtained.

m. The unit is equipped with a water/drip tray. Always operate the unit at least 2 gallons of water. Contents are emptied by unscrewing the drain plug.

Unpacking the unit:

a. After the unit is un-crated, roll the unit and all accessories into place.

b. Remove all vinyl paper on the stainless steel

c. Remove all tape from glass surfaces and metal surfaces

d. Carefully remove and inspect parts that are inside the unit. Ensure that all materials sent with the crate are inspected:

Setting Up The Rotisserie

a. Clean, rinse and sanitize the spits. If baskets and accessories are ordered, clean and sanitize as well.

b. The rotisserie is now ready to be plumbed by a licensed gas fitter.

General Information

The Operating Instructions are to be given to the operator of the rotisserie. All unit operators are to be familiar with the functions of the rotisserie.

The Operating Instructions should be kept in a location close to the rotisserie. It should be easily recognizable and easily accessible.

Electric units can be ordered to meet most electrical specifications.

It is recommended that a repair and maintenance contract be signed with the manufacturer's agent, distributor, or service agency.

WARNING!

This unit must be installed and connected in accordance to the latest regulations and may require operation in conjunction with a forced ventilation or exhaust hood.

**This unit has been designed for professional use only
and may only be installed or repaired by licensed service agencies!
Before installing or using this equipment, read these instructions!**

Machine Drawings and Dimensions

The following drawing of the Front View and Side View indicate where the dimensions are taken and should be used to plan the installation of the units.

N/ 6.5 G

N/ 6.5 G	inches
Height	39-1/2"
Width	40-1/2"
Depth	27-1/2"

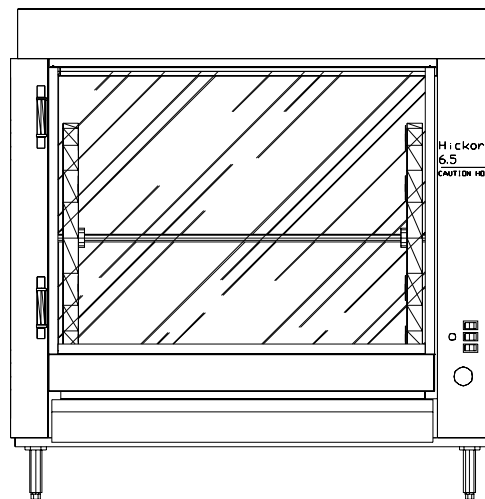

Front View

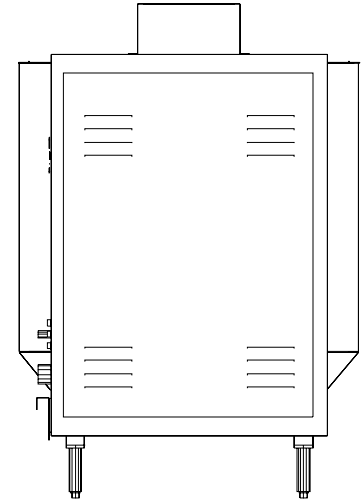

Side View

N/ 7.5 G

N/ 7.5 G	inches
Height	*34-1/2"
Width	50-1/4"
Depth	30"

**Dimension without legs*

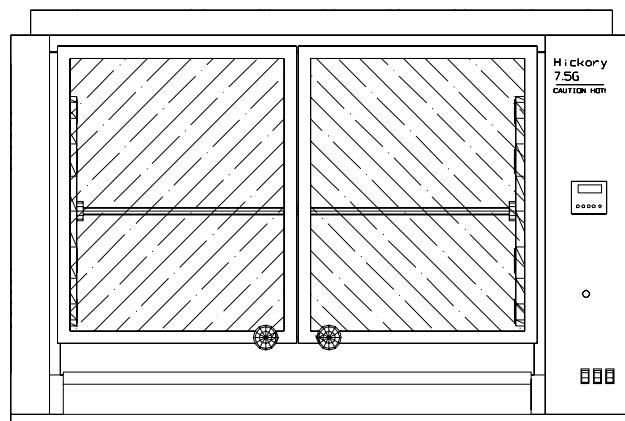

Front View

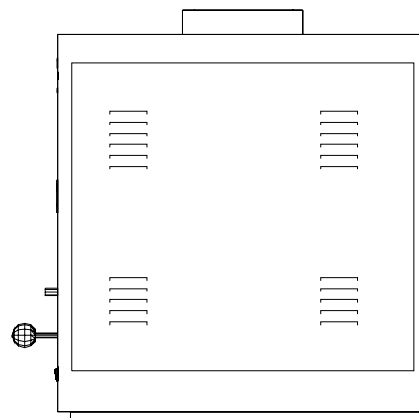

Side View

Spitting Chickens

The most important part in getting started with a rotisserie is knowing how to properly spit the product. This is quite easy, but it must be learned! As an operator, you will become an expert in spitting chickens within half an hour! There are two types of commonly used spits: the angle spit and the regular spit. The following pages describe and show how spitting is done with both these types of spits.

A. Using Angle Spits

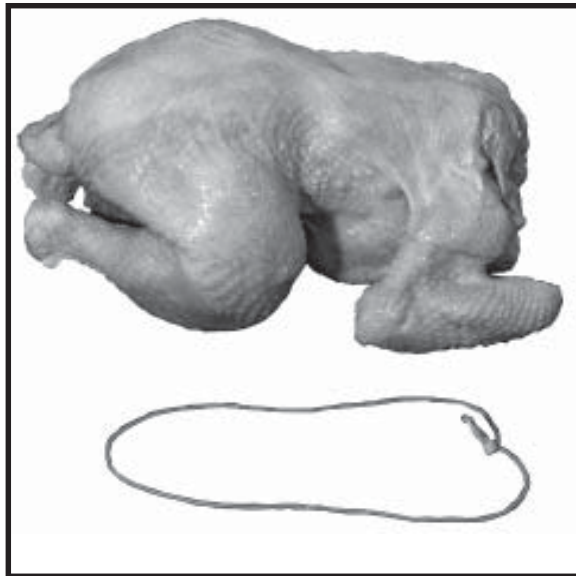

Figure 1. Chickens Ties

When using a “V” or angle spit, it is very important to tie or truss the product being cooked. This prevents the product from moving around the spit and also prevents damage by preventing the legs and wings from flopping. In this section, we will show how to properly truss a chicken. It is important to use a tie to the size of the product. In this case, we are tying a 2³/₄ lb. chicken with a 6” tie.

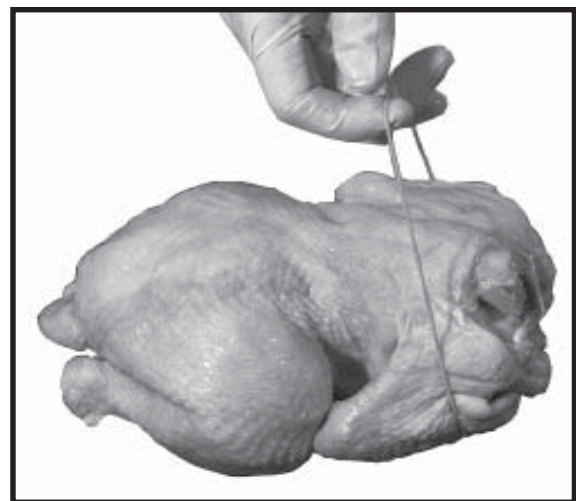

Figure 2. Trussing Wings

With the back of the chicken facing up, take the tie and wrap it around the breast, making sure to tuck the wings against the breast. Pull on the tie as pictured. You will also need to hold the chicken with your other hand.



Figure 3. Trussing Across Back

While pulling on the tie, cross the strings so that you make an “X” across the back of the chicken. With the “loop” in your hand, you will now need to tie the legs of the chicken.



Figure 4. Trussing Legs

While pulling on the tie, loop the strings over the legs of the chicken.



Figure 5. Trussed Legs

Make sure that both legs are securely held by the tie.



Figure 6. Trussed wings

Make sure that both wings are securely held by the tie against the breast of the chicken.



Figure 7. Pop-up Thermometer

The only way to tell if a chicken is done is take the internal temperature. Since it can be difficult to probe the chickens while they are in the rotisserie, we recommend the use of pop-up thermometer. These inexpensive items should be placed in the thickest part of the chicken, which is the breast. The thermostat will “pop-out” when the internal temperature reaches **185° F**.



Figure 8. Chicken Ready to Spit

With the chicken trussed and the pop-up thermometer in place, the chicken is ready to be spitted with an angle spit.

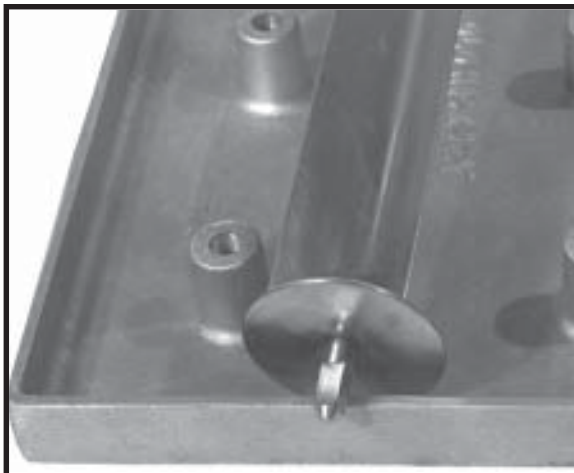

Figure 9. Spitting Accessories

In order to make the use of the angle spits fast and easy, we offer an accessory called a Spit Holder (Hickory Part 195). This aluminum plate offers six holes where the base (square-end) of the angle spit can be inserted.

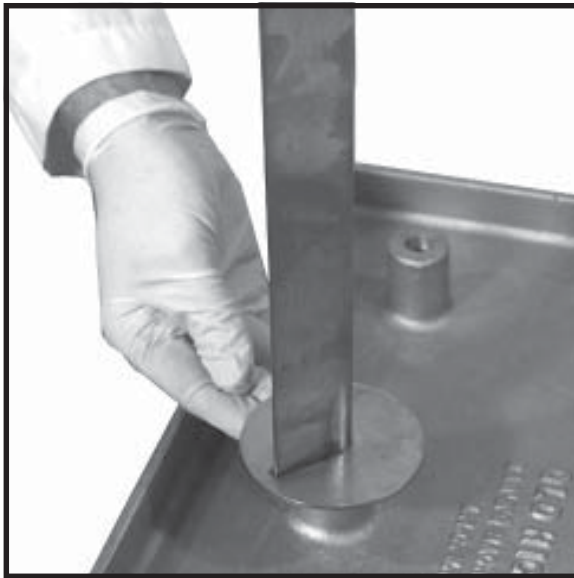

Figure 10. Using the Angle Spit

Insert the bottom (square-end) of the spit into one of the holes in the Spit Holder.



Figure 11. Spitting a Chicken

Spit the chicken through the cavity. The chicken should be inserted through the “head” (or at least where the head used to be) first.

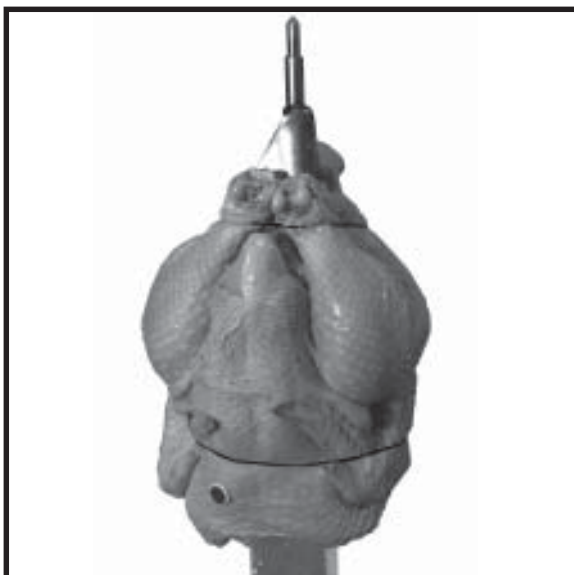

Figure 12. Chicken Position on Spit

When spitting the chicken, make sure that the breast is sitting on the flat, exterior side of the spit. Notice on the picture how the breast is not directly on the rounded corner of the spit, but above one of the flat parts of the “V”. It is also important to note that the legs (and the tie) must sit on the same flat side of the spit. This picture shows exactly how the chicken should look when spitted.



Figure 13. Incorrectly Spitted Chicken

This picture shows a chicken with the legs improperly placed. Note how the chicken seems to hang to one side. When spitted this way, the chickens will tend to “bounce” up and down causing the chicken to breakup.



Figure 14. Complete Spit

After inserting the first chicken, push it all the way to the bottom of the spit and add the next chicken. Depending on the size of the birds and on the rotisserie model, each spit will accommodate three to four $2\frac{3}{4}$ lb. chickens. Once completed, the spit is ready to be placed in the rotisserie.

B. Using Regular Spits



Figure 15. Inserting Single Bottom Skewer

Attach a *single skewer* with a *thumb screw* at least 1/2" from the square end of the spit. The skewer must be on the round section of the spit.

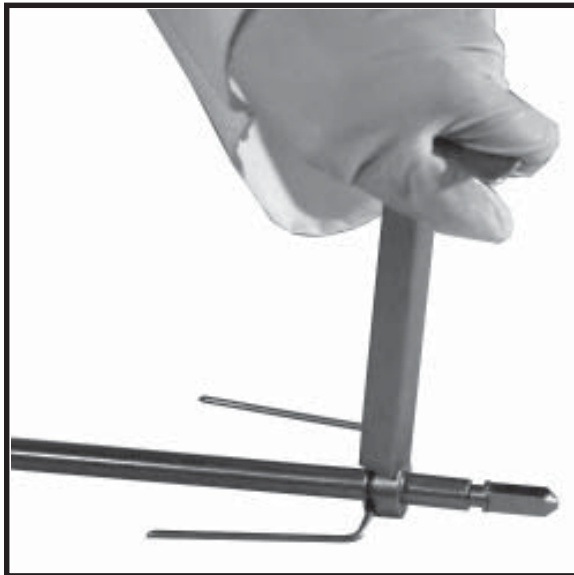

Figure 16. Fastening Bottom Skewer

Use the "T" shaped tool supplied with the unit to tighten the thumb screw. This will prevent the bottom skewer from sliding off the screw.

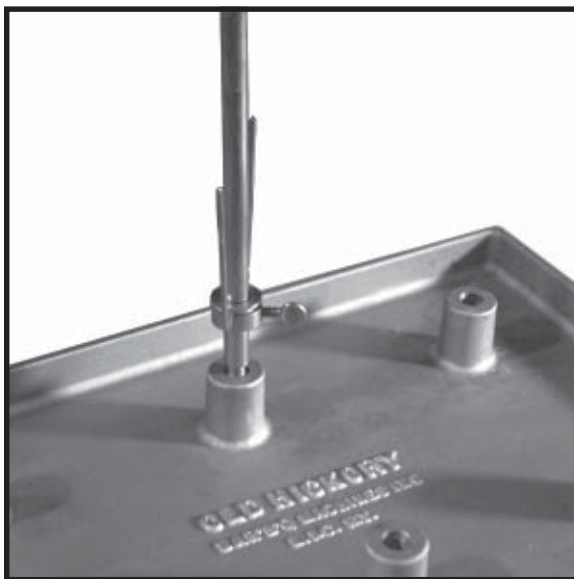
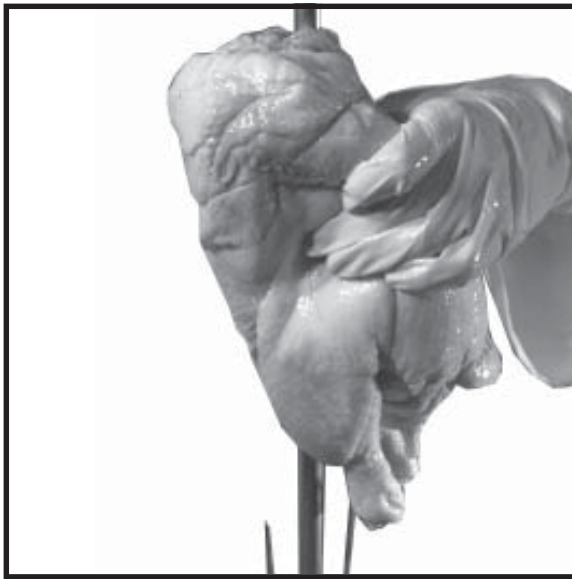

Figure 17. Using the Spit Holder

Even though the chickens can be spitted on a work table, the use of the Spit Holder (Hickory Part 195) will make the spitting process much easier.

Figure 18. Inserting Chicken



Take the chicken, with the drumsticks in the direction of the attached *skewer*, and slide the *spit* through the cavity of the chicken.

Figure 19. Tucking the Legs



The legs must be tucked between the skewer prongs and the center spit. Note that the bottom of the drumstick is what is being locked in place.

Figure 20. Pressing Chicken Towards Skewer

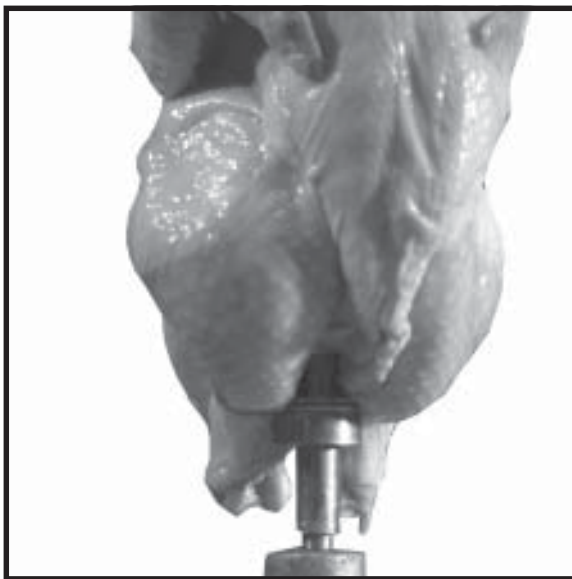

When viewed from the breast side of the chicken, the bottom of the drumstick is being pushed back while the meaty part of the leg is “puffed up” for better presentation. Note that the skewer is not going straight through the drumstick!

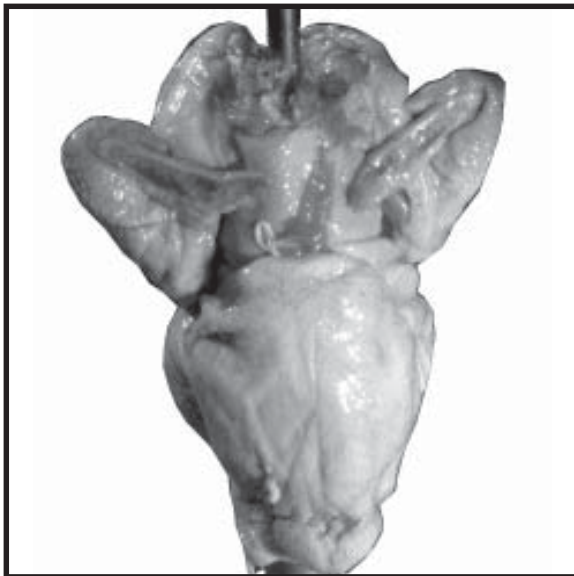

Figure 21. Locking Wings

The wings must be locked or tucked in place. **When using the models N/5.5 and N/10.10, the locking method (pictured here) is only recommended with birds up to 2³/₄ lbs!** With larger birds, the wings must be tucked under the breast, with elastic ties or “wing tuckers”. If the wings are locked on large birds, the wings on the adjacent spits will rub or catch, preventing the spits from rotating freely. This will cause the wings to break off or the gear mechanism to jam.

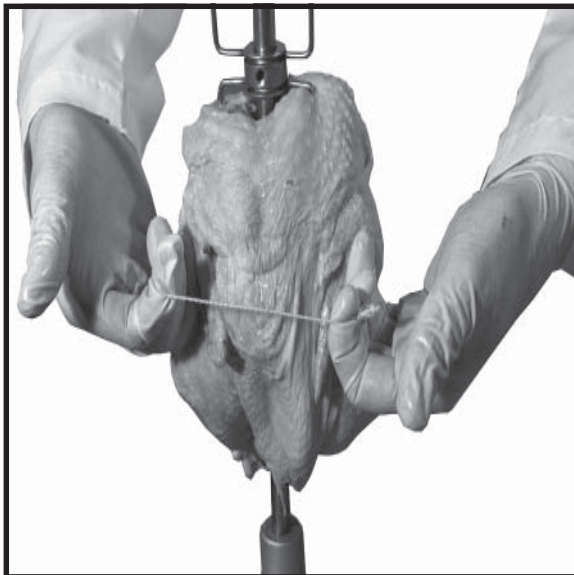

Figure 22. Tucking Wings

With larger birds, the wings must be tucked under the breast, with elastic ties or “wing tuckers”.

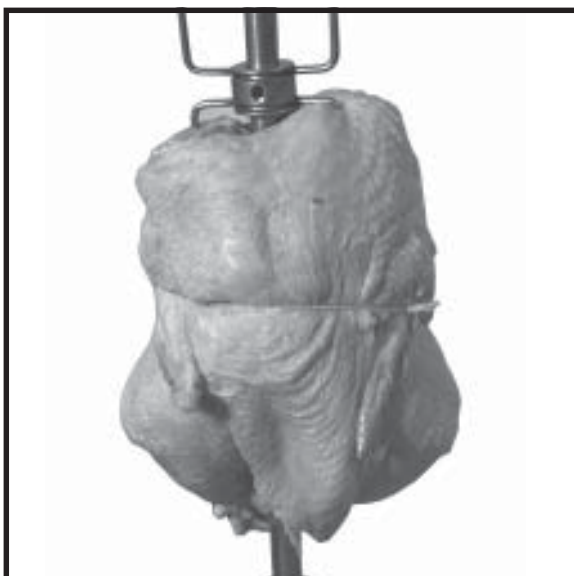

Figure 23. Tucked Wings

Notice how the wings are tucked against the breast. By “tucking” instead of “locking” the wings, the working or rotating diameter of the chicken has been reduced.

Figure 24. Inserting Double Skewers



With the first chicken in place, insert a *double skewer* down the length of the *spit* into the shoulders of the first chicken. **No thumb screw is required for the double skewers!**

WARNING! When driving the double skewer into the chicken, do not exert pressure from the end of the prongs! These are sharp and will pierce a finger or hand if not careful. Only apply pressure at the bottom of the "U" shaped half of the skewer!

Figure 25. Double Skewer in Place



With the double skewer in place, insert the next chicken down the length of the *spit* and position the chicken as previously described.

Figure 26. Loaded Spit

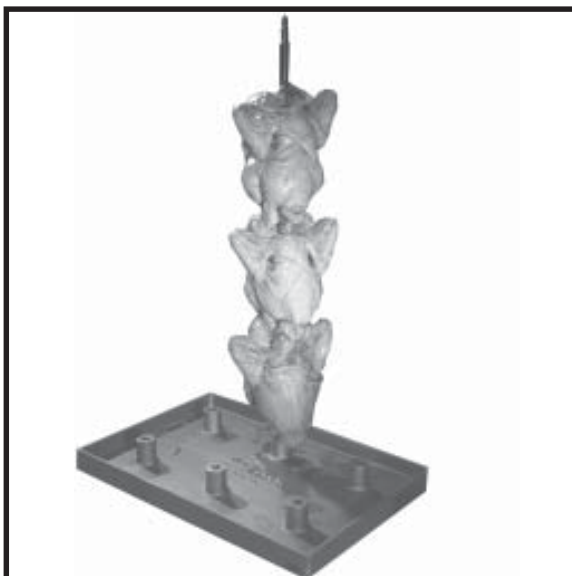

When the loading of the chickens is complete, the end of the spit must be locked in place with another single skewer.

Figure 13. Completing the Load

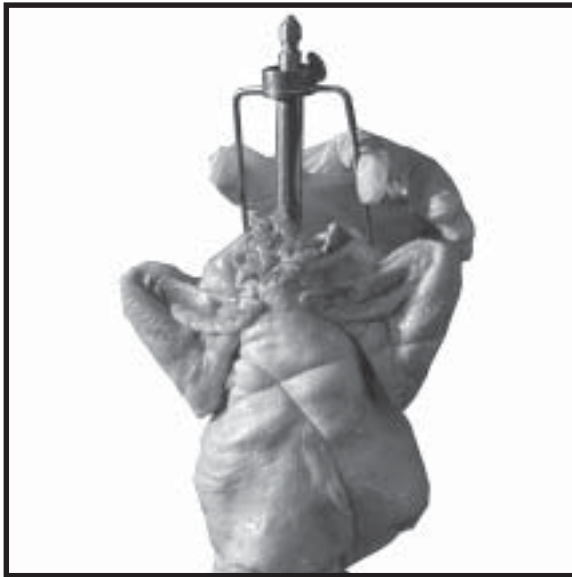

Slide a *single skewer with a thumb screw* into place from the top,

Figure 14. Tightening Final Skewer



Compress the chickens by exerting pressure on this last skewer, and tighten the thumb screw securely.

Figure 15. Securing the Load

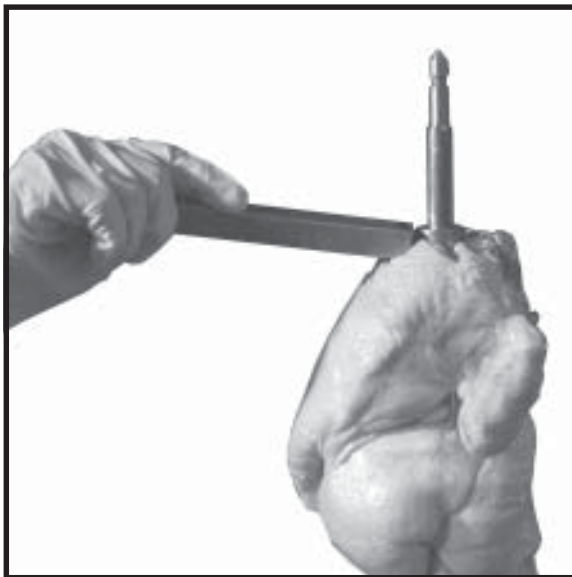

Tighten the *thumb screws* with Hickory's *thumbscrew tightening tool*. This will prevent the chickens from coming loose.

Cooking Preparations

Morning Preparation:

1. Cover the center shaft with aluminum foil.
2. Add water into drip pan (approximately one inch of water should be sufficient. If the unit will be in operation all day, you will need to add more water accordingly.).
3. **Be sure to spray the non-cooking components of the oven with Kote™. (Spray the interior walls; drums and the rear wall with USDA and FDA approved KOTE™.**

Cooking Preparations:

1. Be sure that the rotisserie has been preheated for approximately 20 minutes.
2. Open the glass doors and place the spitted product in the rotisserie. **The pointy end of the spit goes into the circular holes first and the square end next.**
3. Close the glass doors.
4. Choose the program for you cooking options (Refer to Time / Temp Controller Instructions).
5. After the programmed time has elapsed, the timer will beep. Always check the product's internal temperature and ensure that they are at least 180°F.
6. If product is fully cooked, shut off and remove the product from the oven and package accordingly. Take care not to allow the product temperatures to fall below critical temperatures.
7. To start a new load, follow step #1 through #4. **REMINDER: If possible, wipe the glass down with approved glass cleaner between cooking loads. This will facilitate end of day cleaning.**

Cleaning:

1. Shut off all power to the unit.
2. Shut off burner and lights.
3. Let the oven cool down.
4. Remove the aluminum foil from the center shaft.
5. Place a bucket under the drip pan and drain the contents of the drip pan. Close the valve and refill the drip pan with hot soapy water.
5. Wipe the oven surfaces with a rag using the soapy solution; the Kote coating and the fat that has adhered to the Kote will remove very easily. If the unit was not sprayed with Kote, appropriate degreasers / cleaner will be required.
7. When finished cleaning the oven, drain the soapy solution from the drip pan and wipe the drip pan clean.

8. Wipe the glass with a glass cleaning solution. **DO NOT USE RAZOR BLADES, SCOURING PADS OR ANYTHING ABRASIVE TO CLEAN THE GLASS.** You can use an oven cleaner for stubborn spots.
9. Place the spits and skewers in a hot soapy solution. Soak for 15 - 20 minutes – this will loosen the baked on residue. Brush the baskets clean with a scrubbing brush. Follow guidelines for rinsing and sanitizing.
10. You can fill the drip pan with water in advance for tomorrow's cooking cycle.
11. **Recommendation** – It would be a good time to place foil on the center shaft and to spray the oven down with KOTE™ for tomorrow's cooking cycle.

Thermometer Guidelines

When checking product temperature, ensure that you have a calibrated thermometer. A good thermometer should be 1/8" thick and about 6 inches long. The thermometer should not have a dimple. If it does, this is where the thermometer actually measures temperature. This dimple must be placed in the thigh area.

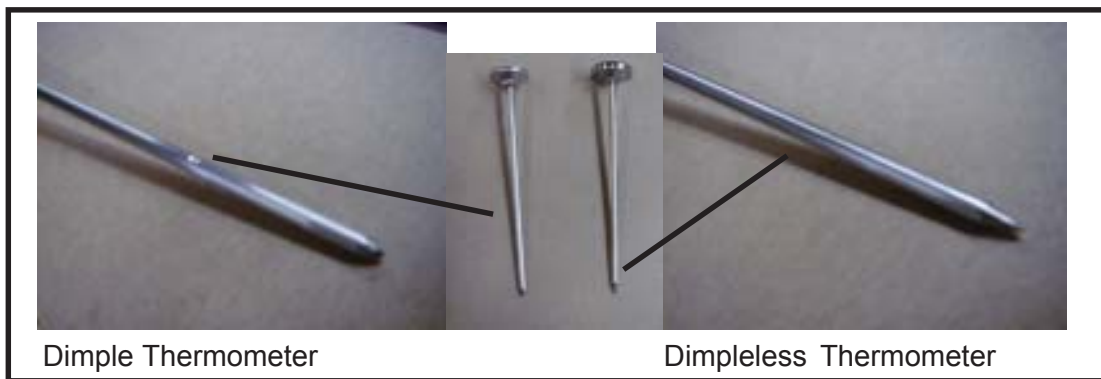

The thermometer should have an easily readable scale. It also should be calibrated using manufacturers recommendation.



When checking for product temperature, insert your thermometer into the meatiest part of the product. When testing chickens, the thermometer should be inserted into the leg and thigh area and it should read 180 to 185 degrees F.



Temperature Chart

Product	Internal Temperature
Poultry	185F
Beef	135-140F Rare 150F Medium 160F Well
Lamb	140F Rare 150F Medium 160F Well
Pork	160F Medium 170F Well

Do's

Do read the manual before operating this unit.

Do clean the rotisserie every day.

Do wipe the the glass between loading and unloading product with a glass cleaner to minimize grease adhesion to the glass.

Do Shut Off power before cleaning

Do let the oven cool down before cleaning.

Do shut the lamps off when cooling the oven down.

Do stop the motor operation using the foot pedal when loading and unloading.

Don'ts

Do Not use a powerwasher to clean the unit

Do Not use abrasives or razors on the glass

Do Not spray anything into the gas burners

Do Not spray anything towards the ignitors

Do Not spray anything towards the lamps when they are hot - glass breakage will occur.

Do Not spray water on the controls.

Do Not leave the oven on all night.

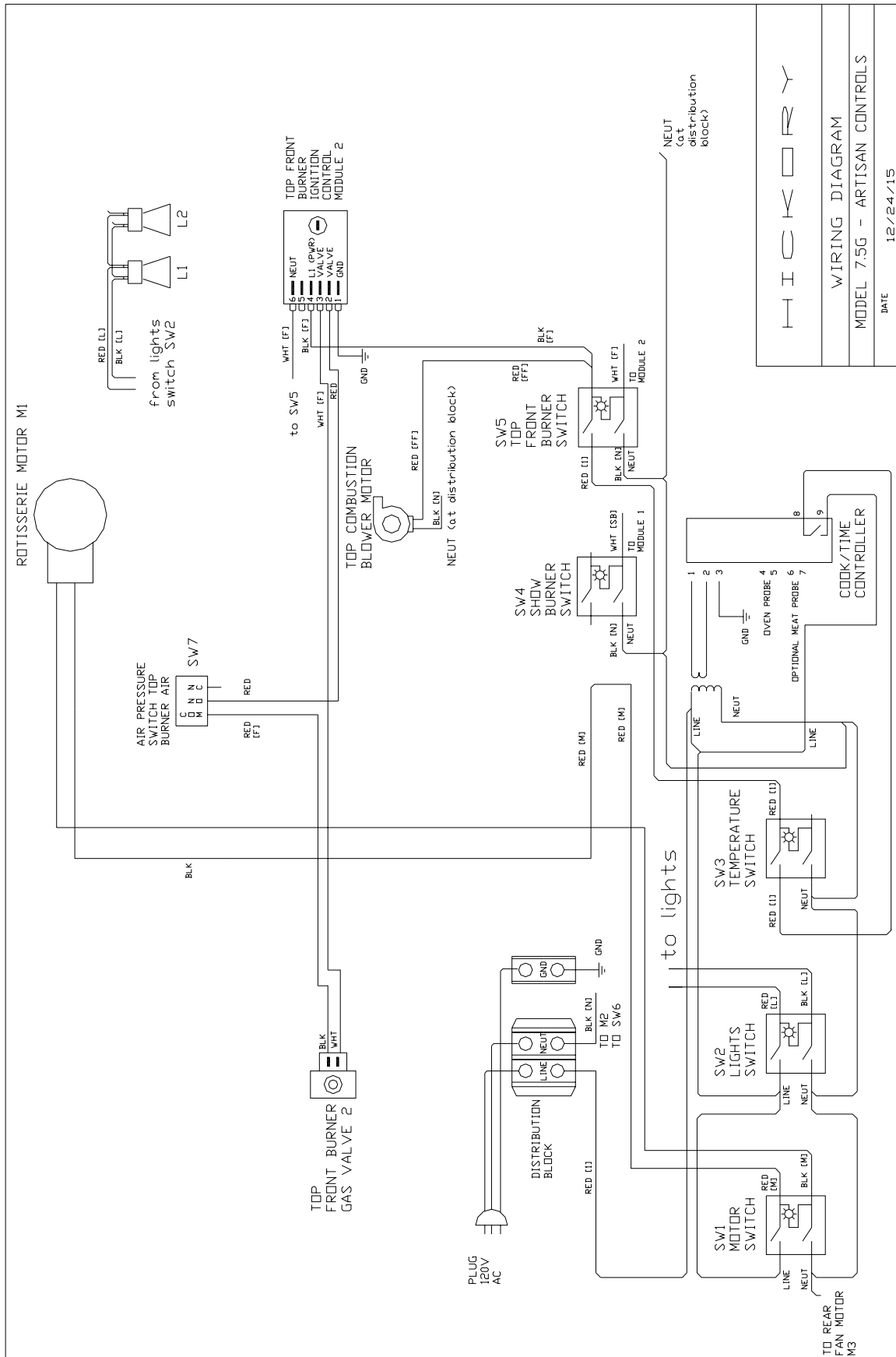

WARRANTY

HICKORY INDUSTRIES, INC., WILL WARRANTY ALL ROTISSERIES FOR ONE YEAR FROM THE DATE OF ORIGINAL INVOICE. WARRANTY INCLUDES ALL PARTS EXCEPT BULBS AND GLASS. WARRANTY CONDITION IS THAT ALL WARRANTY DOCUMENTS MUST BE SIGNED AND MUST BE RETURNED TO HICKORY BY THE USER AFTER RECEIPT OF THE ROTISSERIE. HICKORY RESERVES THE RIGHT TO REVIEW ALL WARRANTY CLAIMS SENT BY ITS AUTHORIZED REPRESENTATIVE. IF NEGLIGENCE OR ABUSE IS FOUND, THE CLAIM WILL BE DISALLOWED.

FOR SERVICE, CONTACT YOUR DISTRIBUTOR OR CALL 1-800-732-9153