

# OPERATOR'S MANUAL

## TXM-15

15"x 15" Swing Away Manual Tortilla Press



*For Customer Service:  
Call 1-800-835-0606 or Visit [hixcorp.com](http://hixcorp.com)*



# CONTENTS

*Receiving & Setup*..... 3

*Operation* ..... 4

*Dough Ball Weights*..... 5

*Cleaning & Maintenance*..... 6

*Dough Shrinkage*..... 7

*Frequently Asked Questions* ..... 7

*Troubleshooting* ..... 8

*Parts List* ..... 10

*Warranty*..... 12

BEFORE warranty repair you MUST get Prior Authorization



Intertek



Intertek

# RECEIVING & SETUP

## UNPACKING

Remember to save all packing materials - including box, liner, and board. You may need these for shipping your machine or if a repair is necessary in the future.

## INSPECTION

Inspect your machine for hidden shipping damage. Contact the delivery company immediately, should you find damage.

## PLATEN SURFACE

Slight surface imperfections are a normal part of the aluminum casting process for the platens on your press. These are not considered a defect and do not affect the functionality of the machine in any way.

## SHIPPING OR RETURNS

**NOTE:** Save all of your shipping/packing materials.

**DO NOT RISK COSTLY SHIPPING DAMAGE. SHIP ONLY IN ORIGINAL BOX**

1. Fasten machine to plywood shipping base with bolts provided.
2. Make sure the handle is pressed down so that the heat platen will not swing around during shipment.
3. Place in original box, and put side liner and top liner in place. Fold in flaps and seal the box.  
*\*Additional bottom boards, box, and liners may be obtained from your supplier for a nominal cost.*

## INSTALLATION

1. Remove tie down straps from press
2. Lift press from box and place on counter top.  
**CAUTION:** Heavy lifting can cause injury. We recommend two person lifting or use of a mechanical aid when handling this press. Remember to always maintain natural curves of the back and bend knees to lift.
3. Plug the cord of the press into a correctly grounded electrical outlet. The correct voltage is indicated on the identification tag of the press.
4. Remove wrap from handle and press.

**NOTE:** Upon receiving your new equipment, some debris or residue may be present on the aluminum platen(s). Clean the platens per the instructions prior to first use.

**WARNING:** Do not use an extension cord to supply power to your press.

This machine is designed in accordance with the NSF/ANSI standard for sanitation to be sealed to the counter-top to prevent the harborage of vermin and the accumulation of dirt and debris. To comply with this standard, the end customer must seal around the perimeter of the base of the machine to the countertop with a food grade RTV silicone sealant that is certified to the NSF/ANSI 51 standard such as Dow Corning #732 Multipurpose Sealant.

**NOTE:** This symbol represents "Hot Surfaces"



# OPERATION

## SETTING UP YOUR PRESS

Move the on/off switch to "ON". \*Up is "ON" and down is "OFF"

## THICKNESS ADJUSTMENT

With the press in the open position, adjust the press to the desired thickness by turning the thickness control knob located at the top/rear of the press. Thickness is reduced by turning the knob **clockwise** and increased by turning the knob **counterclockwise** as indicated. Thickness setting should be set so that the heat head will lock down firmly with your dough in place.

**NOTE:** Adjustments may be required from one product to another and will vary to achieve the desired results,

**CAUTION:** Excessive pressure can cause structural damage, voiding the machine warranty.

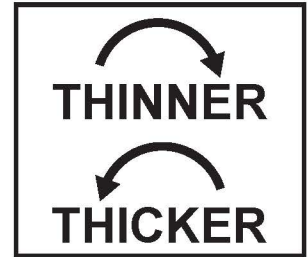

## ADJUST TEMPERATURE

Temperature settings vary for different types and recipes of dough. As a general rule, pressing either corn or flour tortillas, start at 325°F then raise or lower the temperature as needed until the desired results are achieved.

1. Turn the temperature control dial to the desired set temperature.

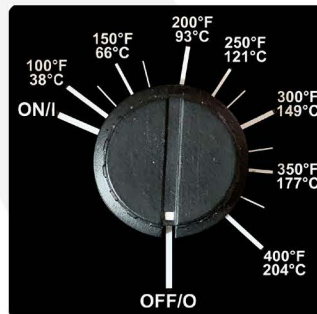

TEMPERATURE CONTROL DIAL

2. The heat indicating lamp will illuminate anytime the platens are heating and will cycle on and off after the set temperature is reached to maintain set temperature.

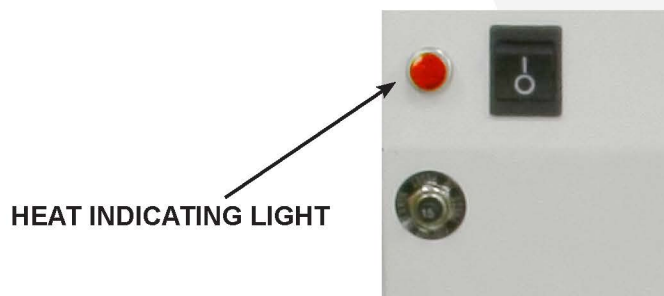

3. A temperature indicating alarm will sound once the set temperature has been reached.

# OPERATION

## PRESSING TORTILLAS

Your tortilla press is designed for easy use and will reliably press your dough balls into tortillas. Thickness, shape, and size is directly related to your dough balls, its shape the temperature of the dough, the recipe of your dough, the type of lubricating food oil, as well as the settings of your machine. You should experiment with the following to determine your desired results.

1. Lightly lubricate the lower platen with olive oil, food/cooking oil, or other food release lubricant when pressing wheat flour dough. Place corn tortilla dough balls between sheets of parchment paper to prevent sticking.

**TIP:** Dough balls at room temperature give you the best results.

**WARNING:** Never attempt to press frozen dough. Personal injury and damage to your press could result.

2. Place your preformed dough ball on the lower platen.  
**FLOUR TORTILLAS:** Dough should be oiled sufficiently in storage trays.  
**CORN TORTILLAS:** Place dough balls between sheets of parchment paper.
3. Pull the handle down all the way, applying pressure, until it stops.
4. After the designated time has elapsed, raise the handle all the way up and swing the upper platen away from the lower platen.
5. Remove your flattened dough. Tortillas can be moved to a tortilla warmer or skillet for finishing.
6. Move on/off switch to "OFF" when you are finished using the press for the day. this will turn the power off to the entire machine.
7. Allow time for the press to cool. Clean press for preparation of next use in accordance with the instructions in this manual.

**NOTE:** Final size is determined by a combination of weight of dough ball and thickness setting.

## DOUGH BALL WEIGHTS

TORTILLA SIZE	WEIGHT OF THE DOUGH BALL
6"	1-1.5 oz.
8"	1.5-2.5 oz.
10"	2.5-3.25 oz.
12"	3.25-3.75 oz.
14"	4-4.5 oz.
16"	4.5-5 oz.

# CLEANING & MAINTENANCE

**WARNING:** Before cleaning, performing maintenance, or repairs make sure the machine is turned off and unplugged.

***\*This appliance is not waterproof. Never spray or pour water or any other cleaning solution onto this appliance.\****

## **CLEANING ALUMINUM UNCOATED PLATENS**

1. Unplug the machine and allow it to cool.
2. Open the heat platen for easier access.
3. Dampen a nonmetallic scrubbing sponge with a mild soap or detergent to remove any excess material from the heat platen(s).
4. Wipe clean with a dry cloth.

## **CLEANING PTFE (XYLAN) COATED PLATENS**

1. Unplug the machine and allow it to cool.
2. Open the heat platen for easier access.
3. Clean the PTFE coated platens with a mild soap and warm water applied with a soft cloth or sponge. Do not use steel wool, scrub sponges, kitchen or oven cleaners, or any other kind of abrasive material. This will damage the coating.
4. Wipe clean with a dry cloth.

## **CLEANING THE OUTSIDE SURFACES OF THE MACHINE**

Use a mild soap and warm water applied with a soft cloth or sponge. Do not use steel wool, scrub sponges, kitchen or oven cleaners, or other abrasives that will damage the painted surface.

## **LUBRICATION**

Your press requires lubrication every 15,000 cycles or every 6 months. Lubricate weekly in a heavy use production environment. Use NSF/NLG12 rated food grade grease (such as Bel-Ray No-Tox #2 or equivalent). A general purpose food grade machine oil spray is also acceptable such as CRC 03055 lubricant. Lubricate all moving or hinged points.

## **CIRCUIT BREAKER RESETTING**

Should the circuit breaker trip, simply allow the machine to cool for 2 minutes and then reset the circuit breaker by pressing the button back in to allow the machine to come back on. If the circuit breaker continues to trip, have an electrician diagnose the cause of the fault.

# DOUGH SHRINKAGE

## WAYS OF OVERCOMING THIS PROBLEM

1. **RECIPE:** What is the percentage of water content in the dough? What is the percentage of oil content in the dough?
2. **MIXING:** Mixing procedure, such as water temperature and mixing speed.
3. **DOUGH PREPARATION:** What is the time between mixing and pressing? How is the dough being stored.
4. **PRESSING:** What is the temperature of the dough when pressing? What is the temperature of the press when pressing? How long is the dough being pressed?

## FAQS

### **Q: Why won't my dough press to size?**

- Weight of the dough ball - not enough dough
- Set to thick - change thickness setting
- Dirty or unclean platens

### **Q: Why won't my dough press out even?**

- Dough ball placement
- Unlevel platens

### **Q: Why is my dough coming apart when I press it?**

- Pressing too long with too much heat
- Not enough oil on dough ball
- Build up on platens

### **Q: What temperature should I be pressing at?**

- 275° - 325°F

### **Q: How long should I be pressing the dough?**

- 2 -3 seconds

### **Q: Can I press corn tortillas?**

- Yes - but you need to use either parchment or baking paper...
  - a. Place paper down on the platen
  - b. Place dough ball(s) on paper
  - c. Place another sheet of paper on top of dough ball(s)
  - d. Press

### **Q: Can I cook the tortillas on the press?**

- Yes - cooking the tortillas on the press can be done in the following manner
  - a. Set press temperature 275° - 325°
  - b. Press dough ball(s) 2-3 second press
  - c. Lift handle and leave tortillas on lower platen for 1 - 1:30 min.
  - d. Turn tortillas over and leave on lower platen for 1 - 1:30 min. on second side.
  - e. Remove

**NOTE:** For faster production and a better finished product, it is recommend to use a two step process using a tortilla press and tortilla warmer.

# TROUBLESHOOTING

## PRESS WON'T TURN ON

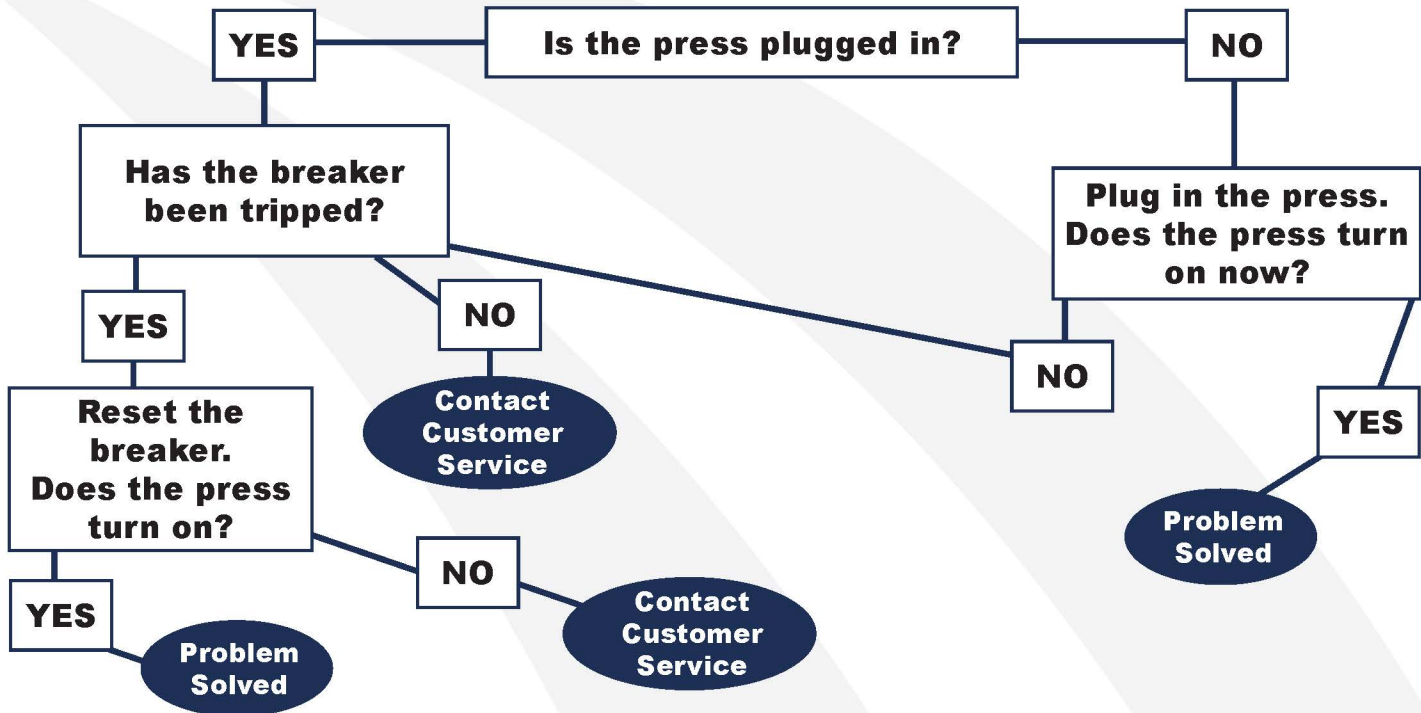

## PRESS IS NOT PRESSING DOUGH ENOUGH

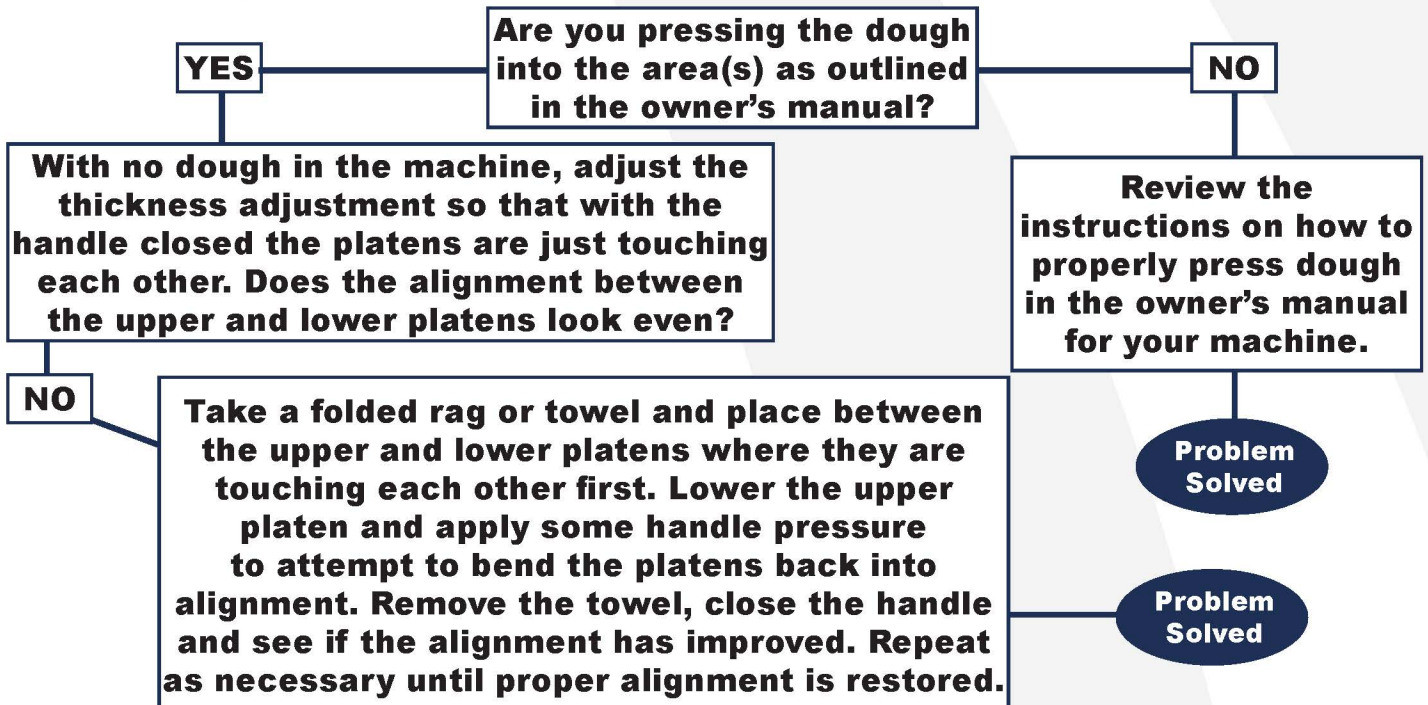

# TROUBLESHOOTING

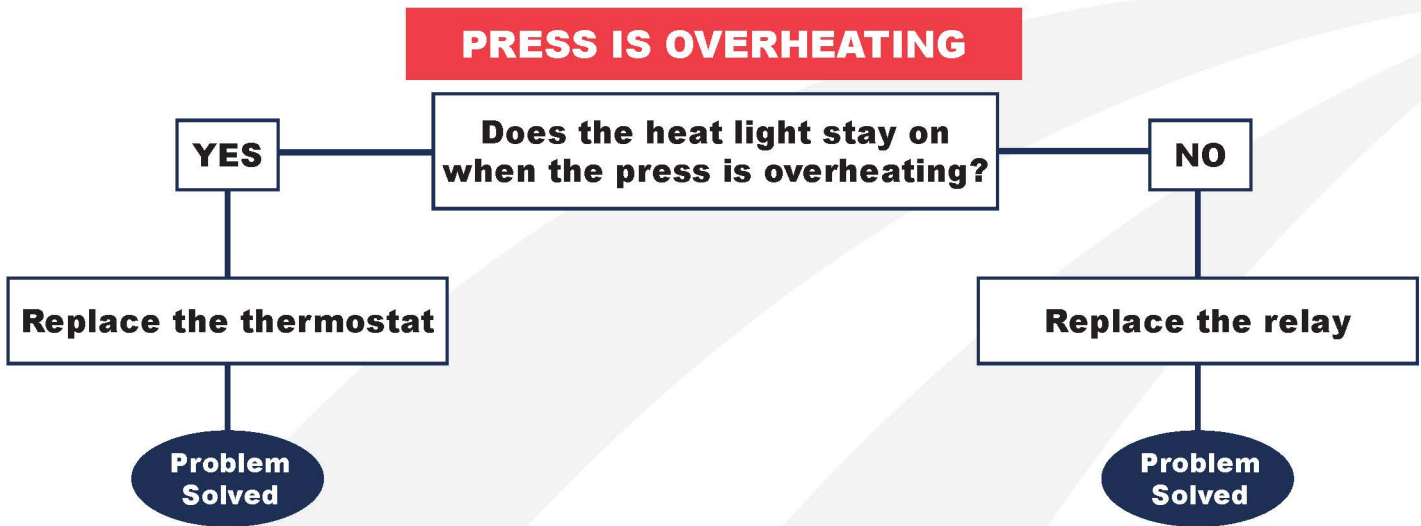

# REPLACEMENT PARTS LIST

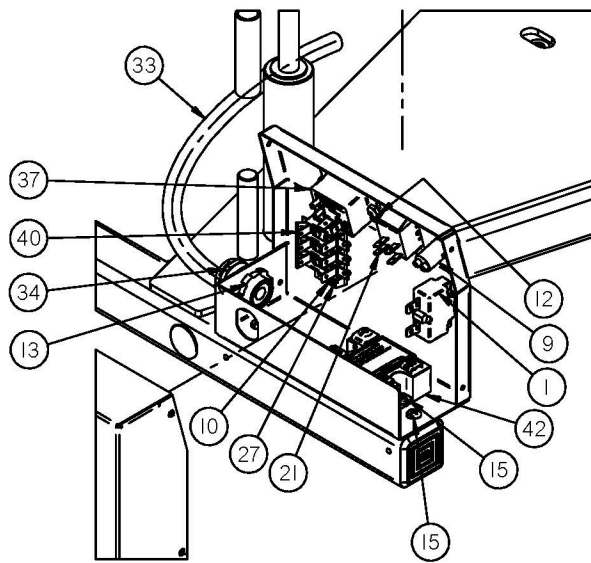
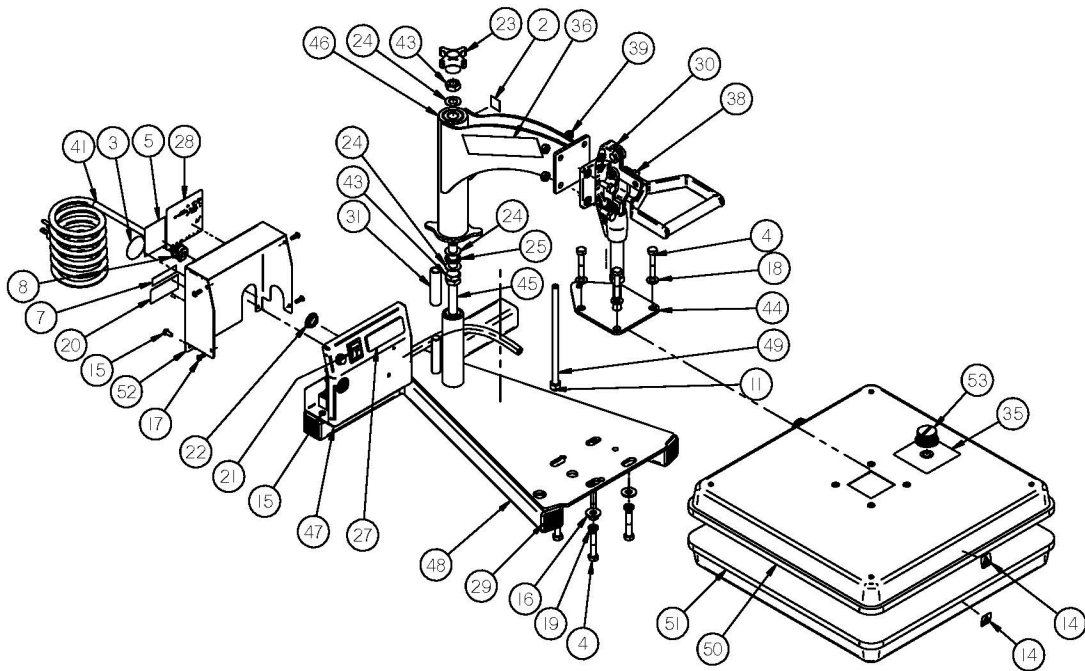

# REPLACEMENT PARTS LIST

ITEM#	PART#	TITLE	ITEM#	PART#	TITLE
1	10349	CIRCUIT BKR 1-POLE PTR 25A ST			
2	10550	DECAL THICK THIN			
3	10664	DECAL MADE IN USA			
4	10793	BOLT 5/16-18x1.750			
5	10963	DECAL, QR CODE DXP			
6*	11431	DECAL, DOUGHXPRESS DOMED 3 X 1			
7	11434	DECAL, FOR SERVICE 2 X .5			
8	13250	CORD GRIP HEYCO 1557 RDD201			
9	14241	LAMP ID RED 220V 1/2" HOLE			
10	14524	SCREW MCH 4-40X0.250 PHPH			
11	14571	NUT 3/8-16 ZPS			
12	14621	NUT 6-32 ZPS			
13	14696	LOCKNUT 1/2" APPL BL50			
14	14910	DECAL HOT SURFACE SYMBOL			
15	15339	SCREW MACHINE 10-24 X .500 PHPH			
16	16683	WASHER FLT .375x0.875x.078 ZPS			
17	21482	SCREW TAP 8x0.500 PHPH			
18	24732	WASHER FLT .344X0.688X.063 ZPS			
19	30910	WASHER LOCK HEL SPR 5/16 ZP			
20	33605	DECAL, UNPLUG MACHINE			
21	37842	SWITCH ROCKER DPST POWER			
22	40980	PLUG HOLE 3/4" STL NI PLATED			
23	62898	KNOB PHENOLIC SWINGMAN			
24	63320	BEARING WSHR .500x0.937x.031			
25	63622	BEARING THRUST .500x0.937x.078			
26*	69086	WIRE KIT TXM-15 220V			
27	70128	WASHER FLT .125x0.313x.025 ZPS			
28	70268	DECAL HIX I.D. 3" X 3" SILVER			
29	70283	PLUG TUBE 1.5x1.5x.120 BLK			
30	70426	CLAMP TOGGLE TXM15 SHOVEL DIP			
31	7051035	TXM15 MAIN ARM STOP SLEEVE			
32*	70611	MANUAL OWNERS TXM-15			
33	70965	CONDUIT LTIGHT 1/4 LT-140			
34	70966	CON CABLE GLAND MCG-1/2			
35	70974	DECAL THERMOSTAT FOOD 400F			
36	71011	M-DECAL DOUGHXPRESS			
37	71057	RELAY SPST 40A 220V			
38	71498	BOLT 5/16-18x0.750 G8			
39	71662	NUT 5/16-18 JAM NYLON INSERT ZPS			
40	72231	TERM BD 601-3-KT37,38,39			
41	72495	CORDSET 220V 14/3 SJTOW 6-20P			
42	84368	RELAY SS 50A 90-280VAC INPUT			
43	87056	NUT 1/2-13 JAM			
44	9140020	SWG15 PLATEN MNT WELDMENT			
45	9141010	SWG15 PRESSURE ADJ ROD			
46	9150030	TXM15 PIVOT ARM WELDMENT CURVED			
47	9150050	TXM-15 CONTROL BOX ASSEMBLY			
48	9151053	FRAME WELDMENT TXM-15 / DXM-PB			
49	9152500	M-TXM15 ANTI ROTATION BOLT			
50	9153002	ASSEMBLY, TXM15 UPPER PLATEN			
51	9153003	ASSEMBLY, TXM15D LOWER PLATEN			
52	9154042	TXM-15 CONTROL BOX COVER ANGLED			
53	94854	KNOB SSAC TIMER (19800)			
54*	9861175	PACKAGING TXM-15			

# WARRANTY

**BEFORE warranty repair you MUST get Prior Authorization: Call 1-800-835-0606 Warranty will be voided otherwise.**

doughXpress® will automatically register the equipment on the date it was shipped to you or your distributor. If the equipment was not purchased directly from HIX, but through a distributor (either domestic or foreign), please keep a copy of their sales invoice showing the serial number and date it was sold/shipped to you with this warranty.

In this case, we will use the distributor's invoice date as the beginning warranty date. **STAPLE A COPY OF YOUR RECEIPT TO THIS WARRANTY** and keep in a safe place to provide verification of your warranty should a problem occur. Thank you.

Please fill in the following information and attach a copy of your receipt for your records.

**Date Purchased:** \_\_\_\_\_ **From:** \_\_\_\_\_

**Model #:** \_\_\_\_\_ **Serial #:** \_\_\_\_\_

This warranty applies to equipment manufactured by the HIX Corporation (HIX), Pittsburg, Kansas, U.S.A. HIX warrants to the original purchaser, the full line of doughXpress® product against defects in workmanship and material, except for wear and tear for a period of one year parts and labor limited warranty on most items, there are selected items which may carry a two year warranty (refer to owners manual.) All dough press carts, compressors, and accessories are warranted for 90 days from the date of purchase. Repairs include parts and labor only, excluding is the following:

1. Overtime Labor Rates
2. Expedited Freight for Parts
3. doughXpress® assumes no responsibility for down time or loss of product. All defective parts must be returned to doughXpress® for credit. Repairs must be pre-authorized by doughXpress® prior to work commencing.
4. Travel time is not covered by doughXpress®, unless pre-authorized by doughXpress®. In the event of a defect, doughXpress®, at its option, will repair, replace or substitute the defective item at no cost during this period subject to the limitations of insurance and shipping costs stated below.

This warranty does not cover normal wear and tear, damages due to accident, misuse/abuse, alterations or damage due to neglect, or lack of proper lubrication or maintenance. doughXpress® shall not be responsible for repairs or alterations made by any person without the prior written authorization by doughXpress®. This warranty is the sole and exclusive warranty of doughXpress® and no person, agent, distributor, or dealer of doughXpress® is authorized to change, amend or modify the terms set forth herein, in whole or in part.

In the case of a problem with the equipment identified herein, doughXpress® should be contacted during regular business hours to discuss the problem and verify an existing warranty. doughXpress® personnel will assist the customer to correct any problems which can be corrected through operation or maintenance instructions, simple mechanical adjustments, or replacement of parts. In the event the problem cannot be corrected by phone, and upon the issuance of a return authorization by doughXpress®, the equipment shall be returned to doughXpress® or an authorized service representative. All insurance, packaging and shipment/freight costs are solely the responsibility of the customer, and doughXpress® shall not be responsible for improper handling or damage in transit.

doughXpress® customer service personnel may be contacted for complete return authorization and reconditioning information. This expressed warranty is given in lieu of any and all other warranties, whether expressed or implied, including but not limited to those of merchantability and fitness for a particular purpose, and constitutes the only warranty made by doughXpress®. In no event shall doughXpress®' liability for breach of warranty extend beyond the obligation to repair or replace the nonconforming goods. doughXpress® shall not be liable for any other damages, either incidental or consequential, or the action as brought in contract, negligence or otherwise.

This warranty gives you specific legal rights and you may also have other rights which vary from state to state.



1201 E. 27th Terrace • Pittsburg, KS 66762 • U.S.A.

Phone: (800) 835-0606 • Fax: 620-231-1598

Web site: [hixcorp.com](http://hixcorp.com) • E-Mail: [sales@hixcorp.com](mailto:sales@hixcorp.com)