



HOSHIZAKI

Parts List

Crescent Cube Icemaker/Dispenser

Models

DKM-500BAJ, BWJ



hoshizakiamerica.com

Number: 71376
Issued: 2-7-2017
Revised: 2-21-2022

CONTENTS

Auxiliary Codes.....	3
Note About Ordering Parts	3
A. Main Assembly	4
DKM-500BAJ.....	4
DKM-500BWJ.....	6
B. Refrigeration Circuit.....	8
DKM-500BAJ.....	8
DKM-500BWJ.....	10
C. Water Circuit.....	12
D. Control Box Assembly.....	14
E. Bin Assembly	16
F. Mechanism Assembly	18
G. Solenoid Assembly.....	20
H. Accessories & Labels.....	22

Auxiliary Codes

DKM-500BAJ

F-0 December 2016
G-0 February 2017
H-0 January 2018
J-0 January 2019
J-1 April 2019
J-2 December 2019

DKM-500BWJ

F-0 December 2016
G-0 February 2017
H-0 February 2018
J-1 April 2019
J-2 December 2019

Auxiliary Code Breakdown

The auxiliary code is the first two characters in the serial number. The first character indicates the year. Years progress or regress in alphabetical order. The series runs from "A" through "V" and the letters "I" and "O" are skipped. The second character indicates significant part changes within a year. Base is "0" and this number advances for each change. In cases where there is a letter in parentheses, this designates the month. This is the last character in the serial number. The series runs from "(A)" through "(M)" and the letter "(I)" is skipped. This designation is only included when identifying a parts change within an auxiliary code.

Note About Ordering Parts

Most assemblies cannot be ordered as complete units; parts in the assemblies generally must be ordered separately.

A. Main Assembly
DKM-500BAJ
 F-0 to J-2

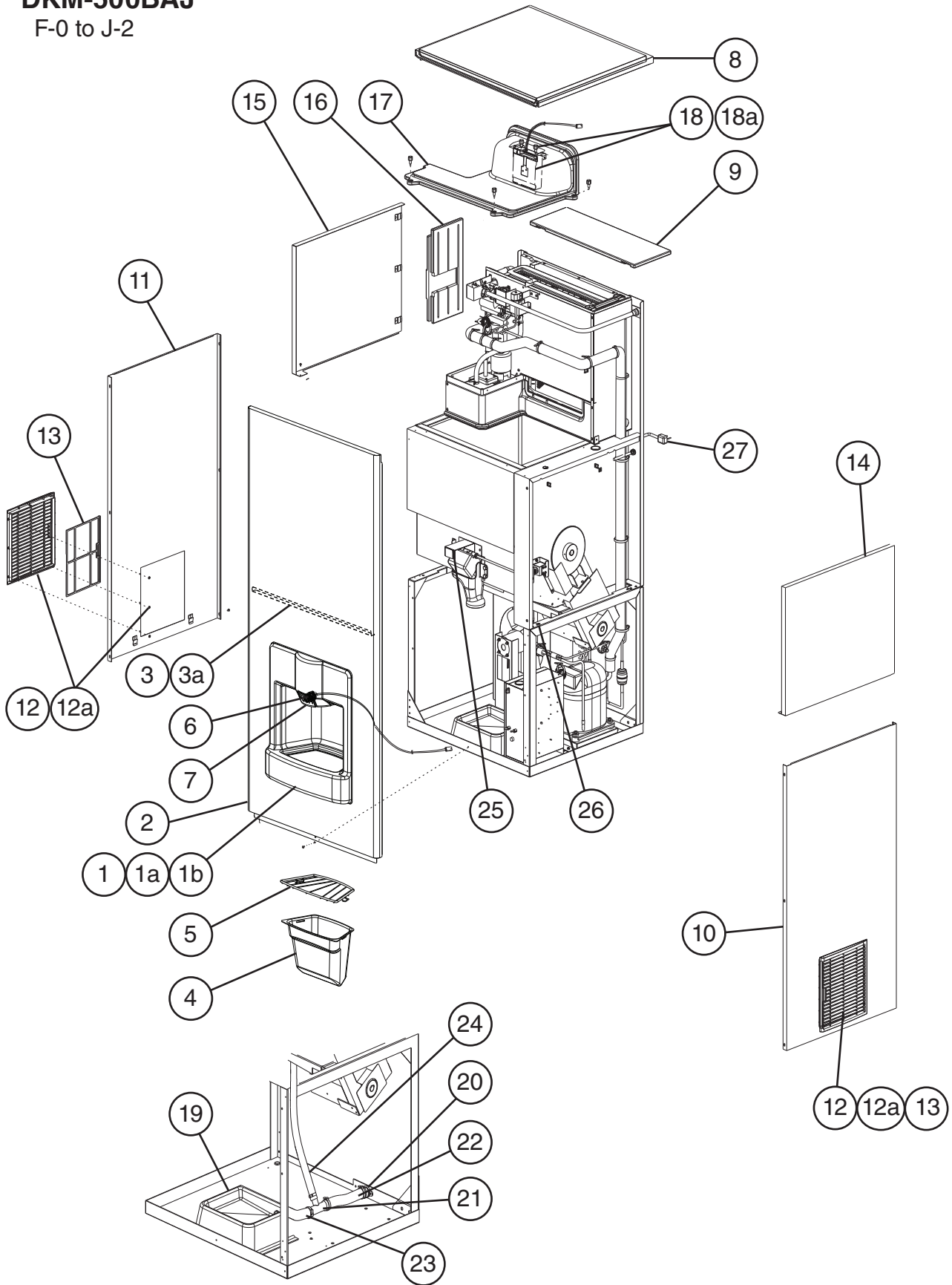

Title: A. Main Assembly Model: DKM-500BAJ											
Index No.	Description	Material or Model Number	Part Number	Required Number							
				F-0 J-0	J-1 J-2						
1	Front Panel A		1A1077-01	1	1						
1a	Foam Tape	L=640 mm	4A2460L01	2	2						
1b	Foam Tape	L=484 mm	4A2460L01	2	2						
2	Front Panel B		1A1076-01	1	1						
3	Front Panel Brace		4A4086-01	1	1						
3a	Foam Tape	L=700 mm	4A2460L01	1	1						
4	Chute		2A3448-01	1	1						
5	Grill		3A3485G01	1	1						
6	Push Switch		460111-01	1	1						
7	Push Switch Button		3A3871-01	1	1						
8	Top Panel		3A3583G01	1	1						
9	Top Insulation		215730G01	1	1						
10	Lower Right Side Panel		2A3530-01	1	1						
11	Lower Left Side Panel		2A4124-01	1	1						
12	Louver		1A0547-01	2	2						
12a	Push Retainer		4A2414-01	6	6						
13	Air Filter		2A2062G01	2	2						
14	Upper Right Side Panel		2A3529G01	1	1						
15	Upper Left Side Panel		2A3532G01	1	1						
16	Side Insulation		2A0664G01	1	1						
17	Bin Cap		1A1142-01	1	1						
18	Bin Control Switch		2A4393G01	1	-						
			2A8598G01		1						
18a	Thumbscrew		434168G02	2	2						
19	Drain Pan Assembly		2A3522G01	1	1						
20	Drain Fitting		4A5528-02	1	1						
21	Tee		4A0525-05	1	1						
22	Vinyl Hose	L=195 mm	4A0658L01	1	1						
23	Vinyl Hose	L=192 mm	4A0658L01	1	1						
24	Vinyl Hose	L=550 mm	7716-2025	1	1						
25	Front Panel Support		4A4133G01	1	1						
26	Rubber Gasket	L=50 mm	4A0662L01	1	1						
27	Power Supply Cord		4A1543-01	1	1						
Hose Clamps											
	Hose Clamp	21-26 mm	4A2017-01	2	2						
	Hose Clamp	32-37 mm	4A2017-03	4	4						

A. Main Assembly
DKM-500BWJ
 F-0 to J-2

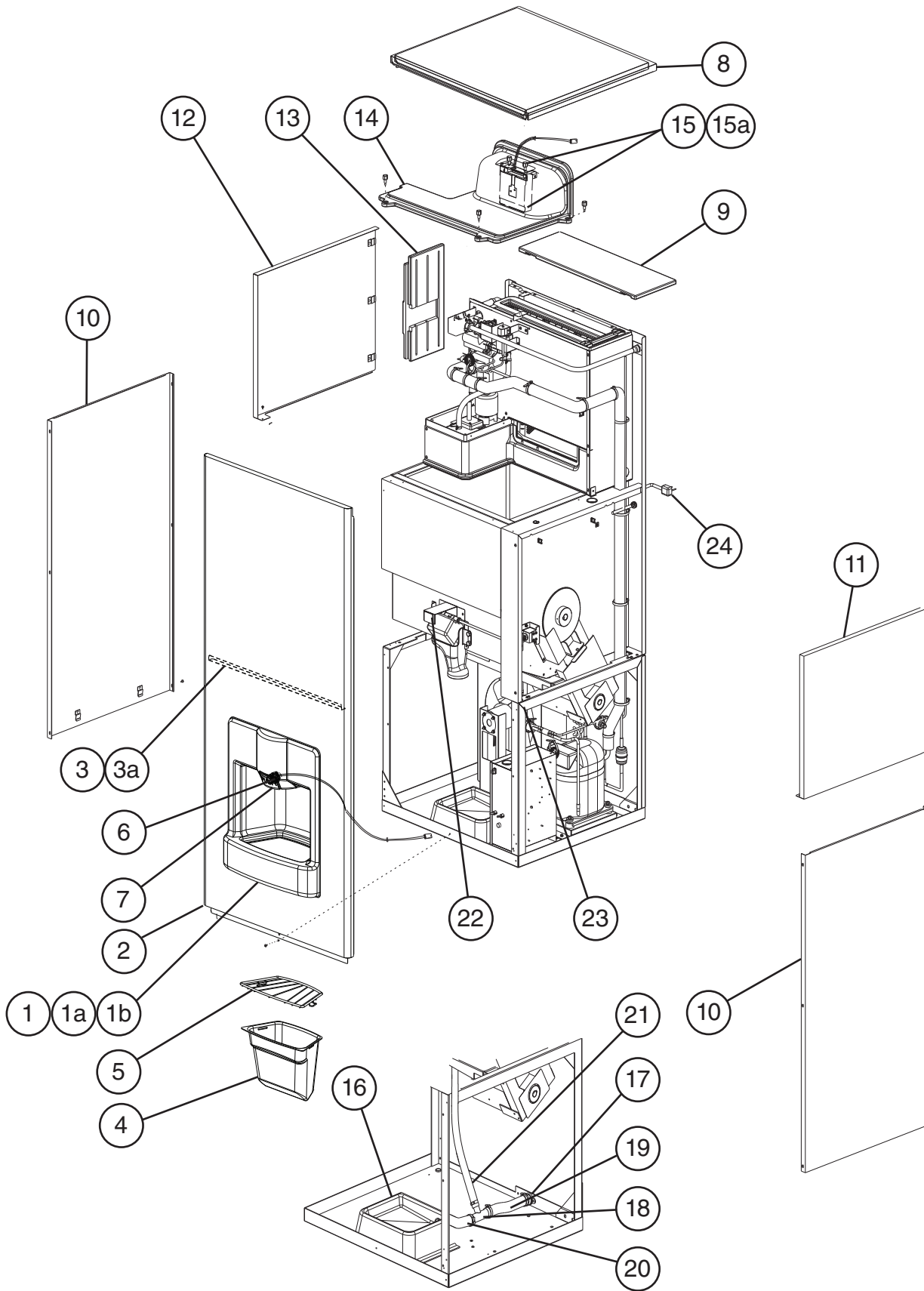

Title: A. Main Assembly Model: DKM-500BWJ											
Index No.	Description	Material or Model Number	Part Number	Required Number							
				F-0 J-0	J-1 J-2						
1	Front Panel A		1A1077-01	1	1						
1a	Foam Tape	L=640 mm	4A2460L01	2	2						
1b	Foam Tape	L=484 mm	4A2460L01	2	2						
2	Front Panel B		1A1076-01	1	1						
3	Front Panel Brace		4A4086-01	1	1						
3a	Foam Tape	L=700 mm	4A2460L01	1	1						
4	Chute		2A3448-01	1	1						
5	Grill		3A3485G01	1	1						
6	Push Switch		460111-01	1	1						
7	Push Switch Button		3A3871-01	1	1						
8	Top Panel Assembly		3A3583G01	1	1						
9	Top Insulation		215730G01	1	1						
10	Lower Right/Left Side Pane		2A4573-01	2	2						
11	Upper Right Side Panel		2A3529G01	1	1						
12	Upper Left Side Panel		2A3532G01	1	1						
13	Front Insulation		2A0664G01	1	1						
14	Bin Cap		1A1142-01	1	1						
15	Bin Control Switch		2A4393G01	1	-						
			2A8598G01		1						
15a	Thumbscrew		434168G02	2	2						
16	Drain Pan Assembly		2A3522G01	1	1						
17	Drain Fitting		438729-01	1	1						
18	Tee		4A0525-05	1	1						
19	Vinyl Hose	L=195 mm	4A0658L01	1	1						
20	Vinyl Hose	L=192 mm	4A0658L01	1	1						
21	Vinyl Hose	L=550 mm	7716-2025	1	1						
22	Front Panel Support		4A4133G01	1	1						
23	Rubber Gasket	L=50 mm	4A0662L01	1	1						
24	Power Supply Cord		4A1543-01	1	1						
Hose Clamps											
	Hose Clamp	21-26 mm	4A2017-01	2	2						
	Hose Clamp	32-37 mm	4A2017-03	4	4						

B. Refrigeration Circuit
DKM-500BAJ
F-0 to J-2

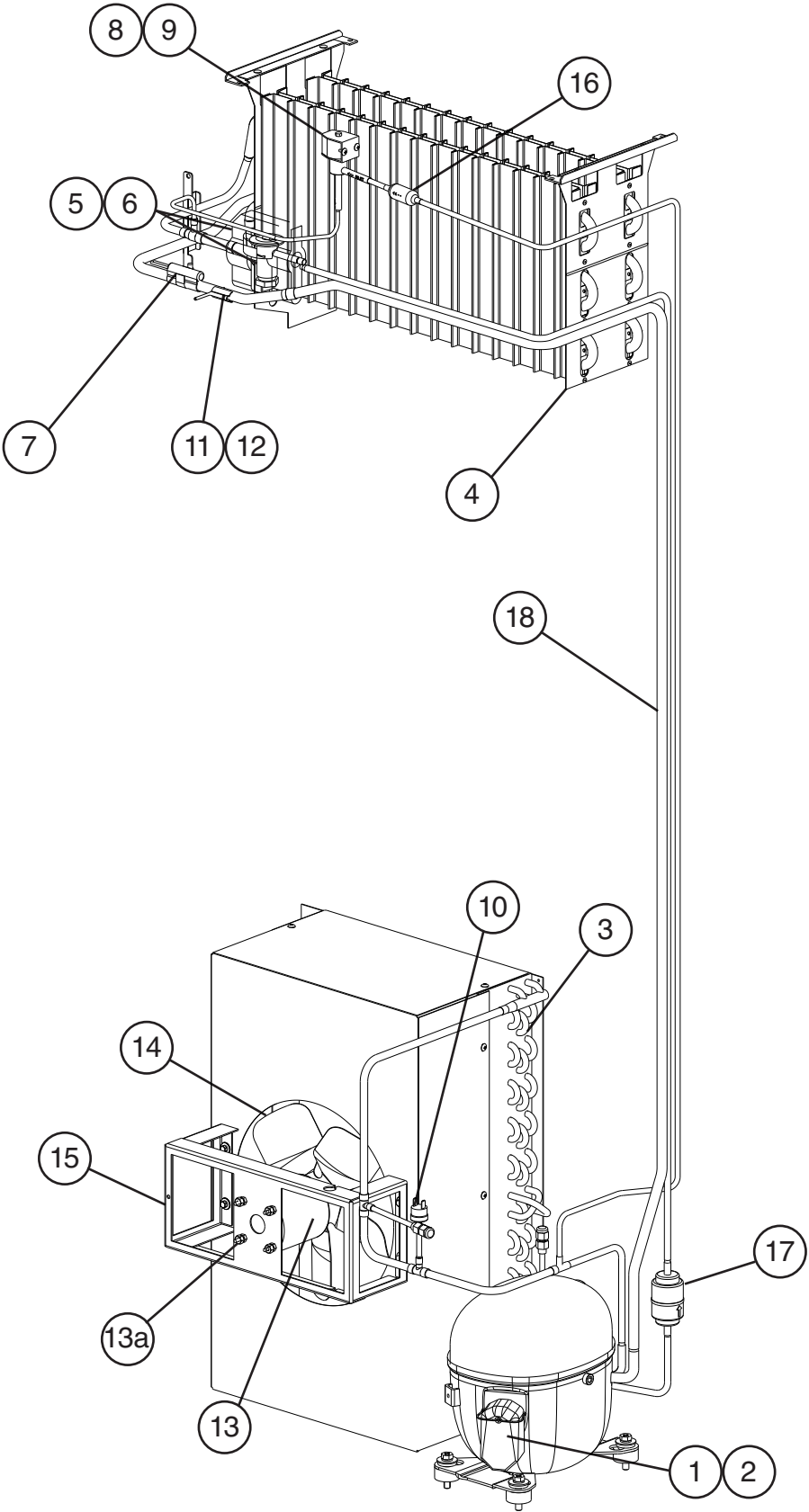

Title: B. Refrigeration Circuit Model: DKM-500BAJ												
Index No.	Description	Material or Model Number	Part Number	F-0 to J-2	Required Number							
1	Compressor		4A5158-01	1								
2	Compressor Sound Cover		4A3992-01	1								
3	Condenser		1A1099-01	1								
4	Evaporator Assembly		2A8120G01	1								
5	Thermostatic Expansion Valve		4A3493-01	1								
6	Thermostatic Expansion Valve Cover		4A1168-01	1								
7	Thermostatic Expansion Valve Bulb Holder		3A0112-01	1								
8	Hot Gas Valve Body		4A3978-01	1								
9	Valve Coil		4A3277-01	1								
10	High-Pressure Switch		463180-04	1								
11	Thermistor		429006-06	1								
12	Thermistor Holder		427430-01	1								
13	Fan Motor		4A3158-01	1								
13a	Self-Locking Nut		7N2110832	4								
14	Fan Blade		4A4014-01	1								
15	Fan Motor Bracket		3A5406-01	1								
16	Strainer		441569-01	1								
17	Drier		4A1113-01	1								
18	Heat Exchanger		2A8273G01	1								

B. Refrigeration Circuit
DKM-500BWJ
F-0 to J-2

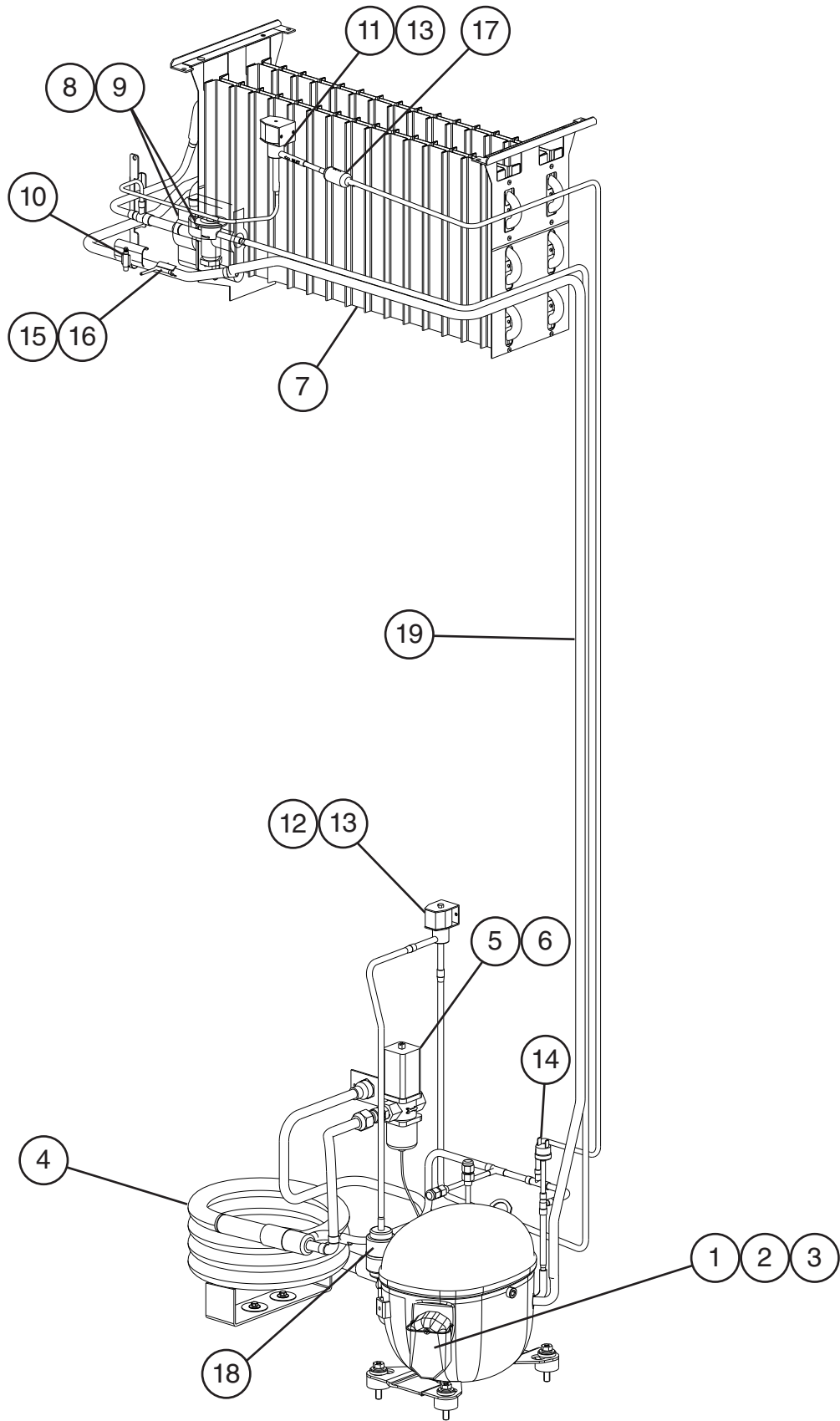

Title: B. Refrigeration Circuit Model: DKM-500BWJ												
Index No.	Description	Material or Model Number	Part Number	F-0 to J-2	Required Number							
1	Compressor		4A4376-01	1								
2	Compressor Sound Cover		4A3992-01	1								
3	Compressor Protector		4A2634-02	1								
4	Water Cooled Condenser		3A7321-01	1								
5	Water Regulating Valve		4A0911-06	1								
6	Male Connector		4A1087-01	1								
7	Evaporator Assembly		2A8120G01	1								
8	Thermostatic Expansion Valve		4A3493-01	1								
9	Thermostatic Expansion Valve Cover		4A1168-01	1								
10	Thermostatic Expansion Valve Bulb Holder		3A0112-01	1								
11	Hot Gas Valve Body		4A3978-01	1								
12	Liquid Line Valve Body		4A3276-01	1								
13	Valve Coil		4A3277-01	2								
14	High-Pressure Switch		463180-05	1								
15	Thermistor		429006-06	1								
16	Thermistor Holder		427430-01	1								
17	Strainer		441569-01	1								
18	Drier		4A1113-01	1								
19	Heat Exchanger		2A8283G01	1								

C. Water Circuit
DKM-500B_J
F-0 to J-2

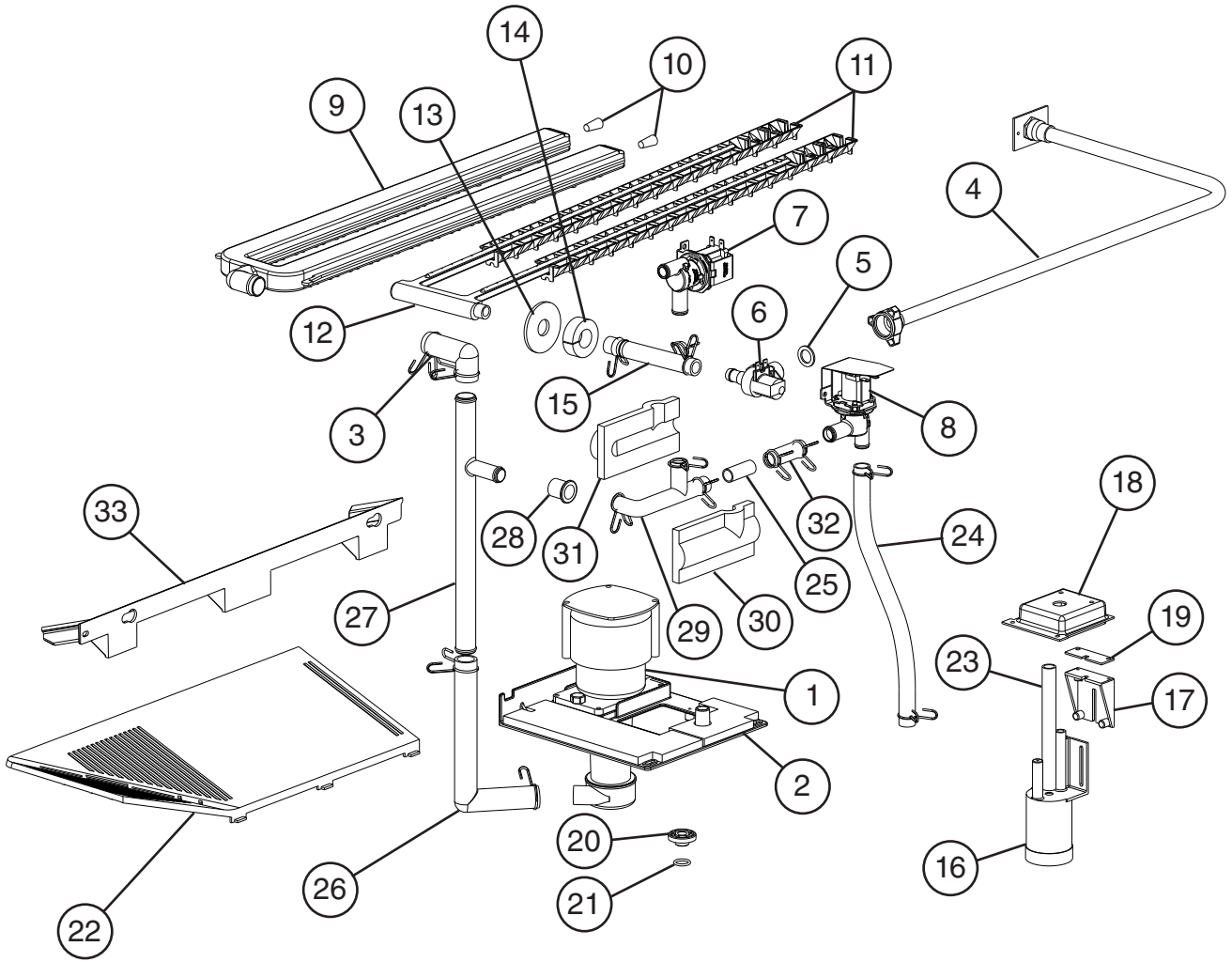

Title: C. Water Circuit Model: DKM-500B_J												
Index No.	Description	Material or Model Number	Part Number	F-0 to J-2	Required Number							
1	Pump Motor		4A4259-01	1								
2	Pump Motor Bracket		2A4920G01	1								
3	Elbow		4A0393-01	1								
4	Water Supply Pipe		3A3589G01	1								
5	Rubber Gasket		413854-03	1								
6	Inlet Water Valve		4A5251-06	1								
7	Cleaning Valve		4A5745-01	1								
8	Drain Valve		4A5745-03	1								
9	Spray Tube		1A0260-02	1								
10	Plug		4A0176-01	2								
11	Spray Guide		2A4282-02	2								
12	Water Supply Tube		2A0079-01	1								
13	Flange		439267-01	1								
14	Insulation E		4A0392-01	1								
15	Water Supply Tee		4A1006-01	1								
16	Float Switch		4A3624-03	1								
17	Float Switch Bracket		327757-01	1								
18	Float Switch Cover		3A0665-01	1								
19	Float Switch Spacer		4A5888-01	1								
20	Drain Plug		309246-01	1								
21	O-Ring		7611-P015	1								
22	Cube Guide		2A0660-01	1								
23	Vinyl Hose	L=150 mm	7716-1216	1								
24	Vinyl Hose	L=458 mm	7716-1519	1								
25	Joint Pipe		439329-01	1								
26	Hose B		325867-01	1								
27	Connecting Pipe		3A1335-01	1								
28	Rubber Ring		4A1004-01	1								
29	Bypass Hose		4A1005-01	1								
30	Bypass Hose Insulation A1		4A1259-01	1								
31	Bypass Hose Insulation A2		4A1260-01	1								
32	Vinyl Hose	L=55 mm	7716-1519	1								
33	Cube Guide B		3a9028-01	1								
Hose Clamps												
	Hose Clamp	25 mm	427443-03	4								
	Hose Clamp	18 mm	427443-05	10								

D. Control Box Assembly
DKM-500B_J
 F-0 to J-2

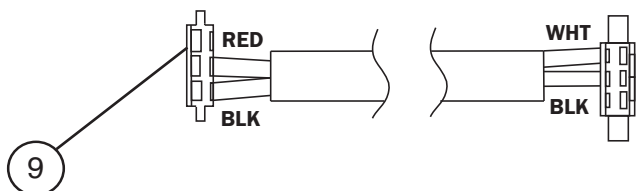
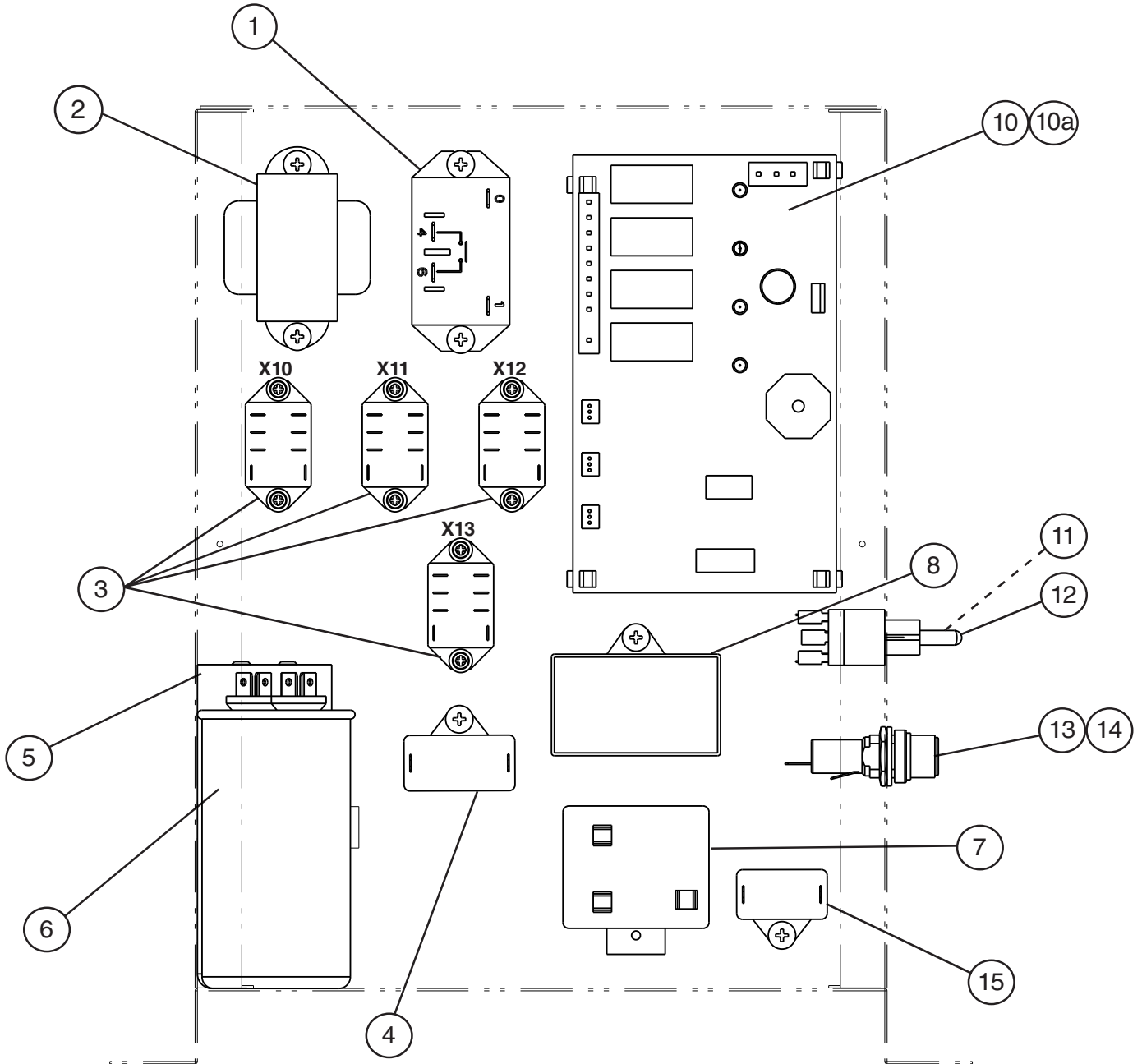

Title: D. Control Box Assembly Model: DKM-500B_J											
Index No.	Description	Material or Model Number	Part Number	F-0 to J-2	Required Number						
1	Compressor Relay		4A3140-01	1							
2	Control Transformer		3A0172-01	1							
3	Relay (X10 = Pump Direction X11 = Inlet Water Valve X12 = Anti-Slush X13 = Ice Dispense)	120VAC	406132-07	4							
4	Fan Motor Capacitor	DKM-500BAJ 5MFD, 250VAC	443192-02	1							
5	Start Capacitor	DKM-500BAJ 243-292MFD, 250VAC	3A0076-21	1							
		DKM-500BWJ 243-292MFD, 165VAC	3A0076-20	1							
6	Run Capacitor	DKM-500BAJ 40MFD, 440VAC	3A2005-07	1							
		DKM-500BWJ 35MFD, 440VAC	3A2005-12	1							
7	Start Relay	DKM-500BAJ	4A1107-20	1							
		DKM-500BWJ	4A1107-11	1							
8	Gear Motor Capacitor	20MFD, 250VAC	4A4319-02	1							
9	Bin Control Wire Harness	L=1220 mm	4A2200G06	1							
10	"J" Control Board		2A7664-04	1							
10a	Control Board Support		4A0336-03	4							
11	Service Switch (toggle)		4A0985-01	1							
12	Control Switch (toggle)		443119-01	1							
13	Fuse	AGC-10A, 250VAC	4A0893-07	1							
14	Fuse Holder		4A5443-01	1							
15	Pump Motor Capacitor	2.5MFD, 250VAC	4A2128-05	1							

E. Bin Assembly
DKM-500B_J
F-0 to J-2

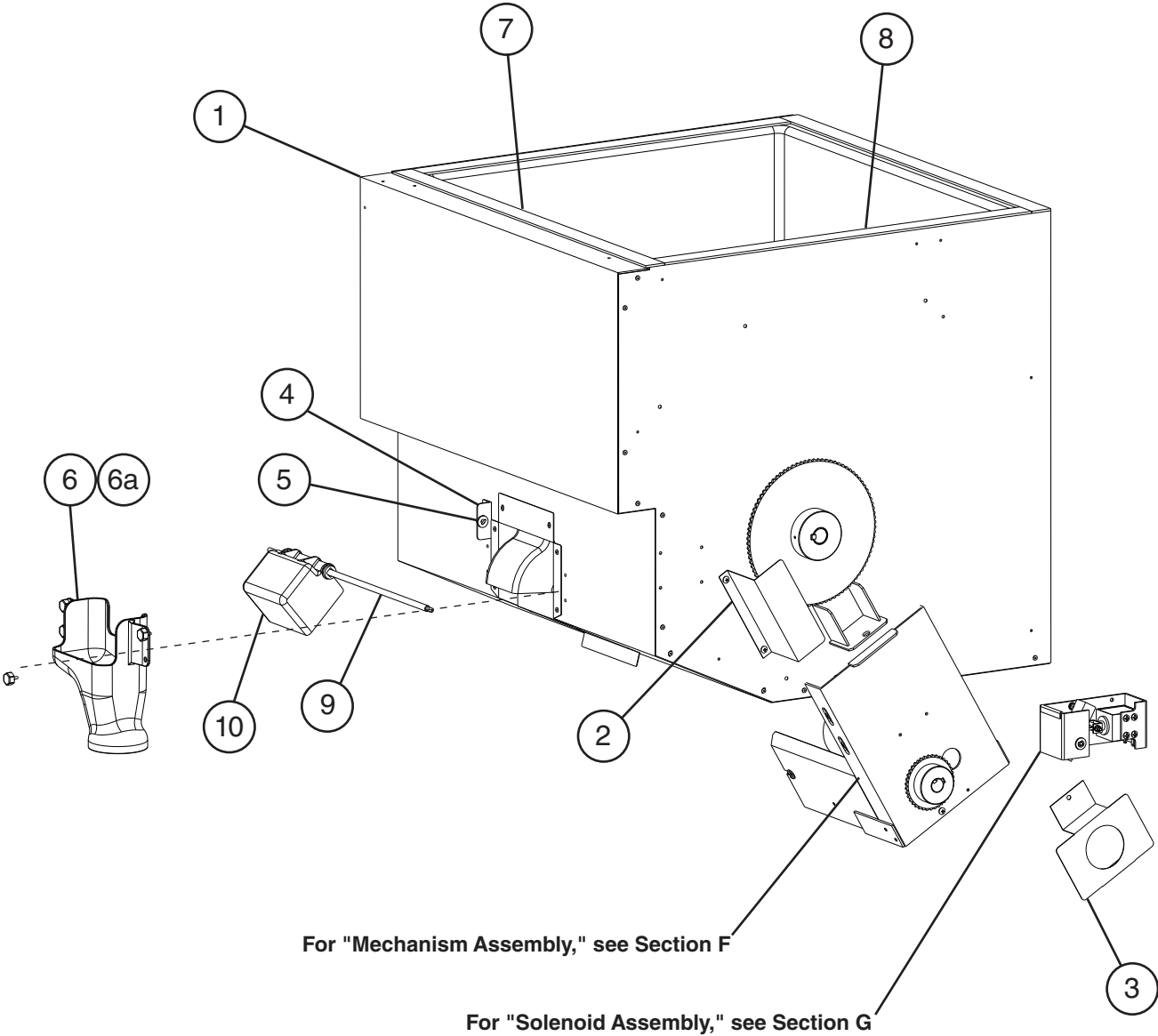

Title: E. Bin Assembly Model: DKM-500B_J												
Index No.	Description	Material or Model Number	Part Number	F-0 to J-2	Required Number							
1	Bin Body		106184G04	1								
2	Chain Cover A		438282-01	1								
3	Chain Cover B		438283-01	1								
4	Shutter Collar Bracket		439399-01	1								
5	Shutter Collar		435533-01	1								
6	Spout		2A3528-01	1								
6a	Thumbscrew		415949G08	4								
7	Gasket	L=650 mm	4A0808L01	2								
8	Gasket	L=580 mm	4A0808L01	2								
9	Shutter Shaft		328648-01	1								
10	Shutter		215459-01	1								

F. Mechanism Assembly
DKM-500B_J
F-0 to J-2

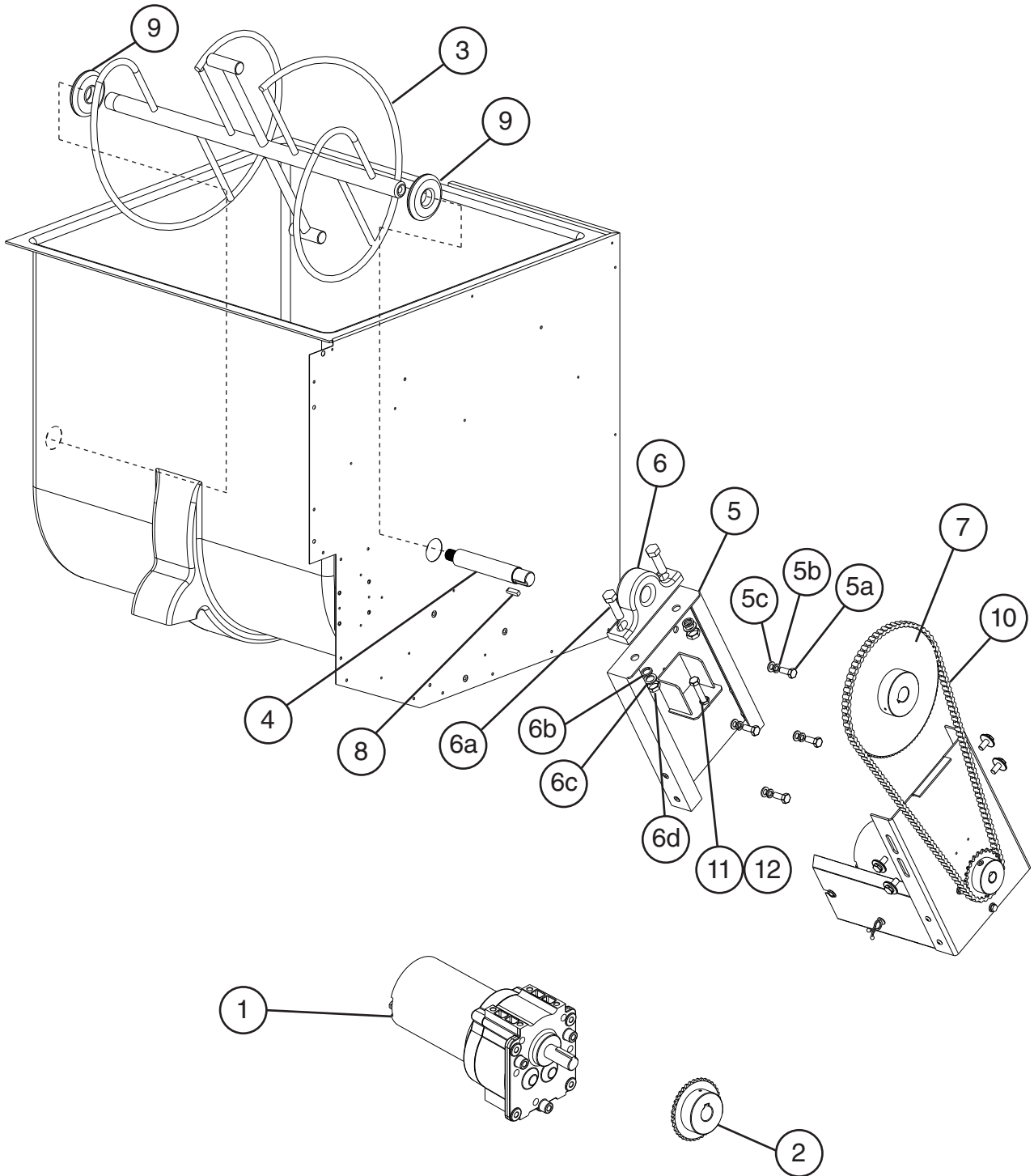

Title: F. Mechanism Assembly Model: DKM-500B_J												
Index No.	Description	Material or Model Number	Part Number	F-0 to J-2	Required Number							
1	Gear Motor		4A5055-01	1								
2	Small Sprocket A	(w/5x8 set screw)	4A4413-01	1								
3	Agitator		212969G01	1								
4	Drive Shaft		435551-01	1								
5	Gear Motor Bracket A		2A0450G01	1								
5a	Hex Head Bolt		7B01-0820	4								
5b	Split Lock Washer		7L21-0800	4								
5c	Flat Washer		7W21-0800	4								
6	Pillow Block Bearing		435553-02	1								
6a	Hex Head Bolt		7B01-1240	2								
6b	Flat Washer		7W21-1200	2								
6c	Split Lock Washer		7L21-1200	2								
6d	Hex Nut		7N11-1200	2								
7	Large Sprocket B	No. 35x65T (w/6x18 set screw)	435554-01	1								
8	Key	6x6x22	437265-01	1								
9	Seal B		435558-01	2								
10	Chain		435797-01	1								
11	Hex Head Bolt	8x45	7B01-0845	1								
12	Hex Nut		7N11-0800	1								

G. Solenoid Assembly
DKM-500B_J
F-0 to J-2

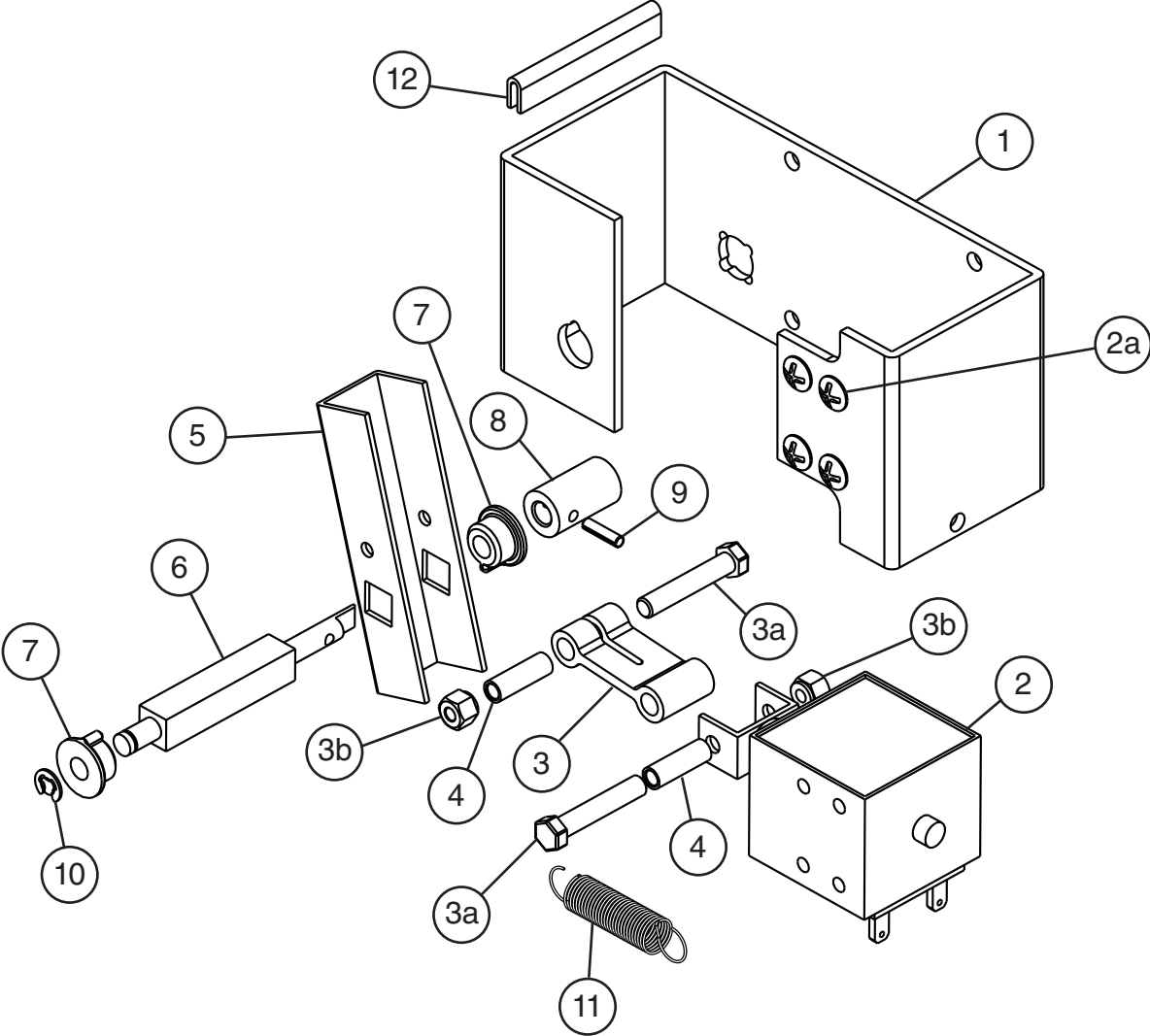

Title: G. Solenoid Assembly Model: DKM-500B_J												
Index No.	Description	Material or Model Number	Part Number	F-0 to J-2	Required Number							
1	Solenoid Bracket		3A0533-01	1								
2	Solenoid		4A0856-01	1								
2a	Truss Head Screw		7C32-0408	4								
3	Link		432232-01	1								
3a	Hex Head Bolt		7B02-0430	2								
3b	Self-Locking Nut		7N22-0400	2								
4	Collar D		432471-01	2								
5	Solenoid Link		439397-01	1								
6	Shaft		435532-01	1								
7	Shutter Collar		435533-01	2								
8	Connector		435534-01	1								
9	Spring Pin		712S-0312	1								
10	E-Ring		721S-0005	1								
11	Spring		432878-01	1								
12	Rubber Gasket	L=50 mm	4A0662L01	1								

H. Accessories & Labels

DKM-500B_J

F-0 to J-2

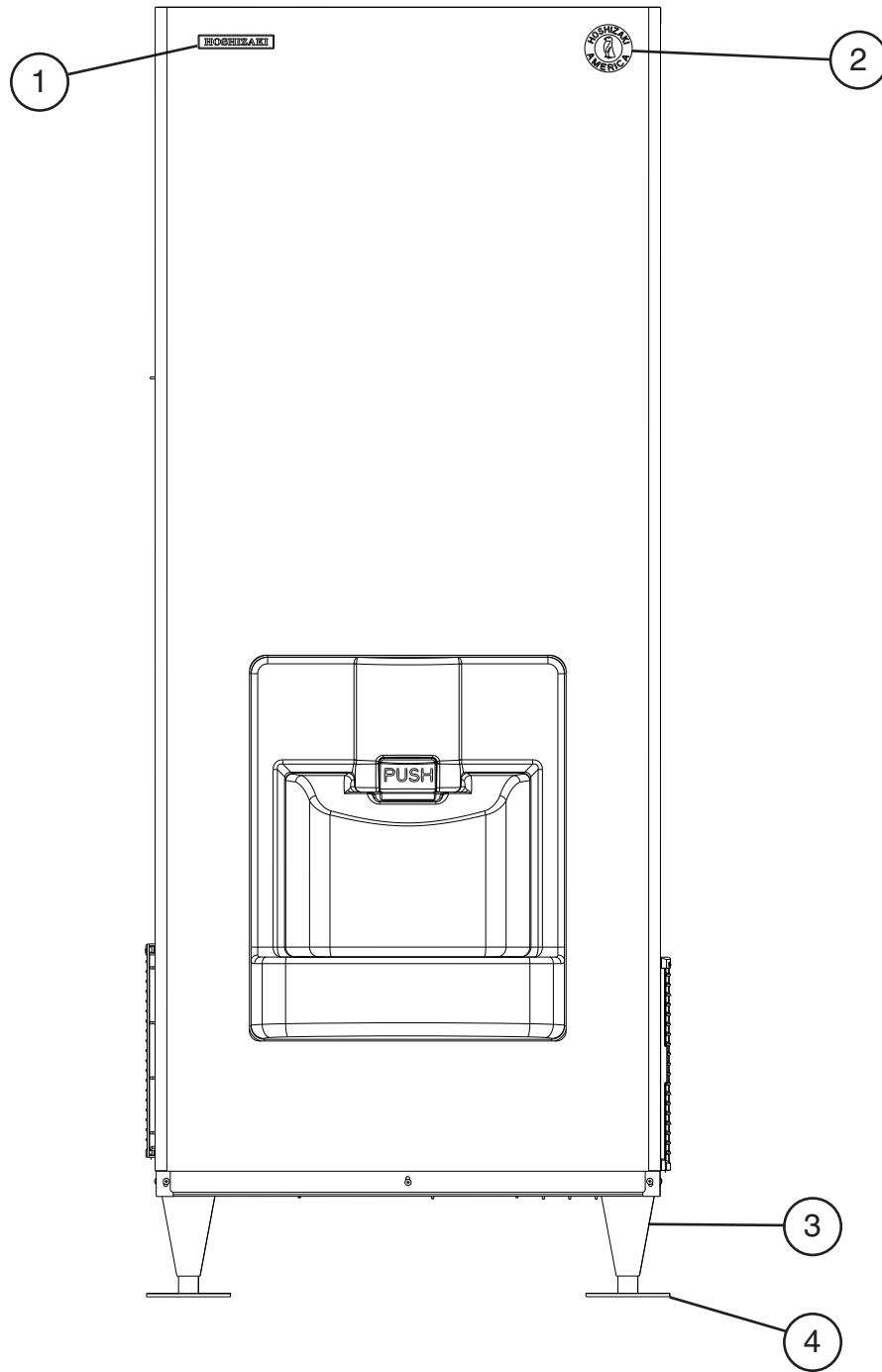

Title: H. Accessories & Labels Model: DKM-500B_J					Required Number								
Index No.	Description	Material or Model Number	Part Number	F-0 to J-2									
1	Emblem		4A0560-01	1									
2	Penguin Label		4A0526-02	1									
3	Adjustable Leg		4A2526-01	4									
4	Leg Protector		3A0134-01	4									