

WIRE COLOR CODE

BR	BROWN
W	WHITE
BK	BLACK
R	RED
O	ORANGE
GY	GRAY
P	PINK
DBU	DARKBLUE
V	VIOLET
Y	YELLOW
LBU	LIGHTBLUE
W/R	WHITE/RED

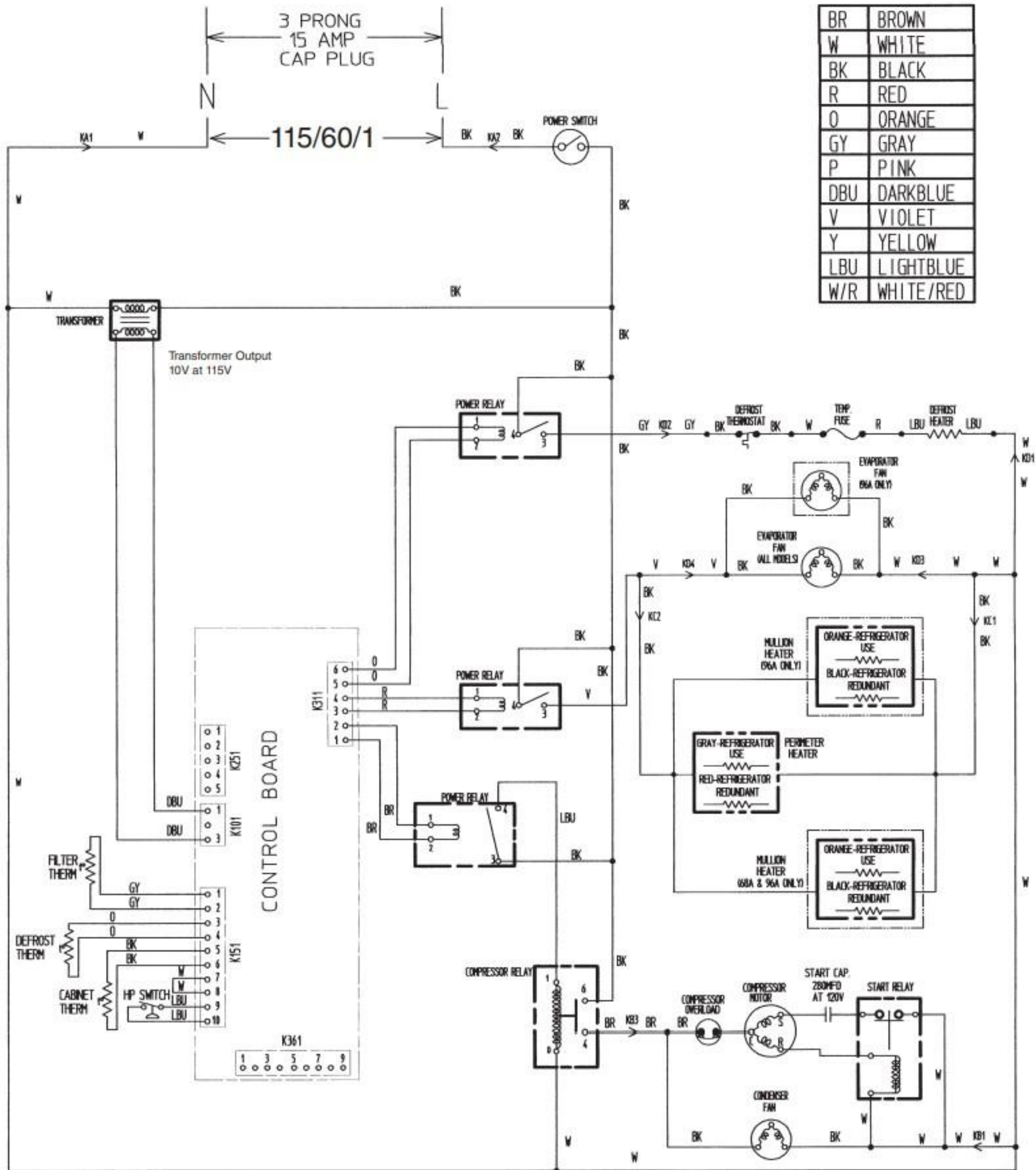

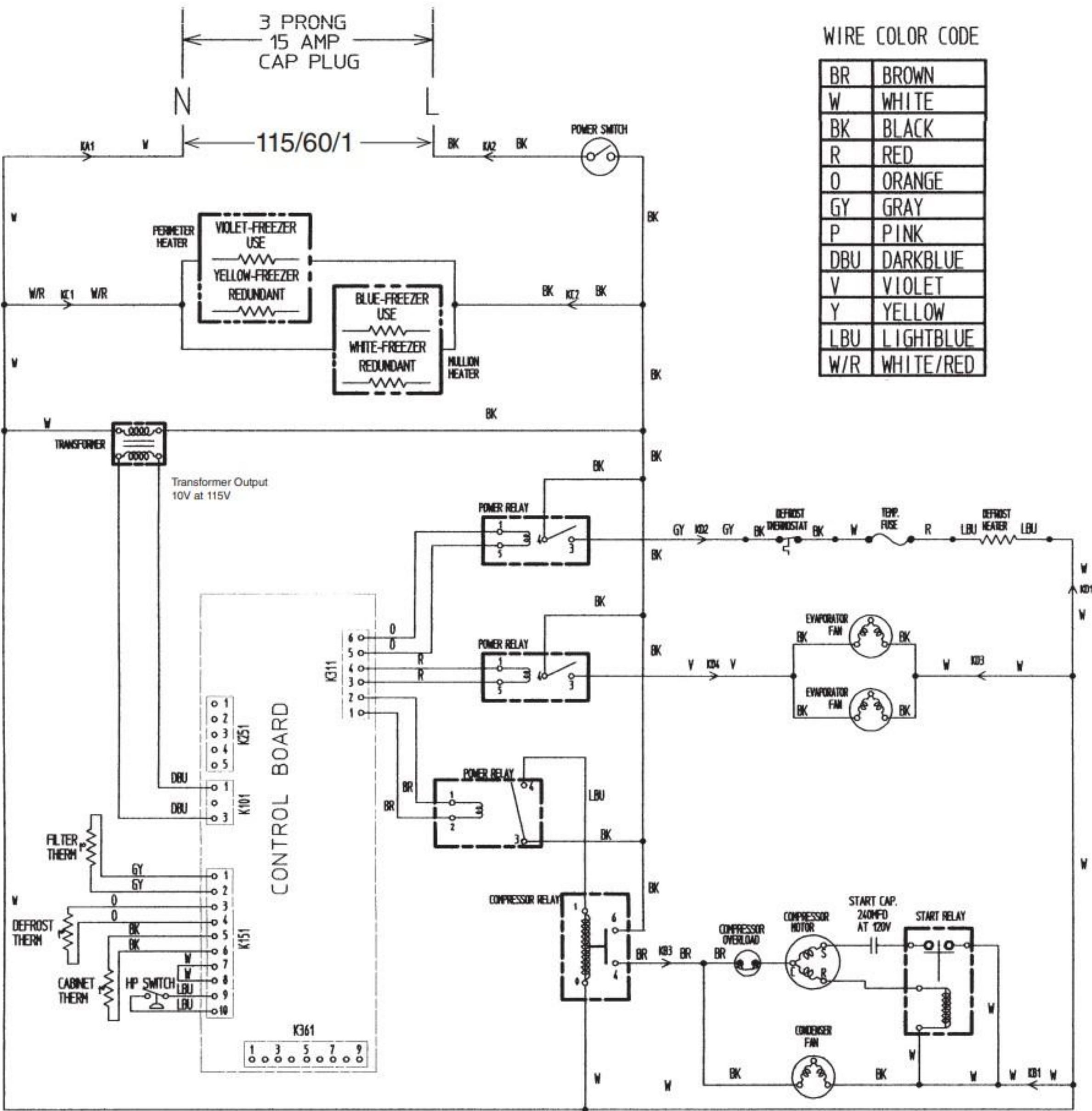

# WIRE COLOR CODE

BR	BROWN
W	WHITE
BK	BLACK
R	RED
O	ORANGE
GY	GRAY
P	PINK
DBU	DARKBLUE
V	VIOLET
Y	YELLOW
LBU	LIGHTBLUE
W/R	WHITE/RED

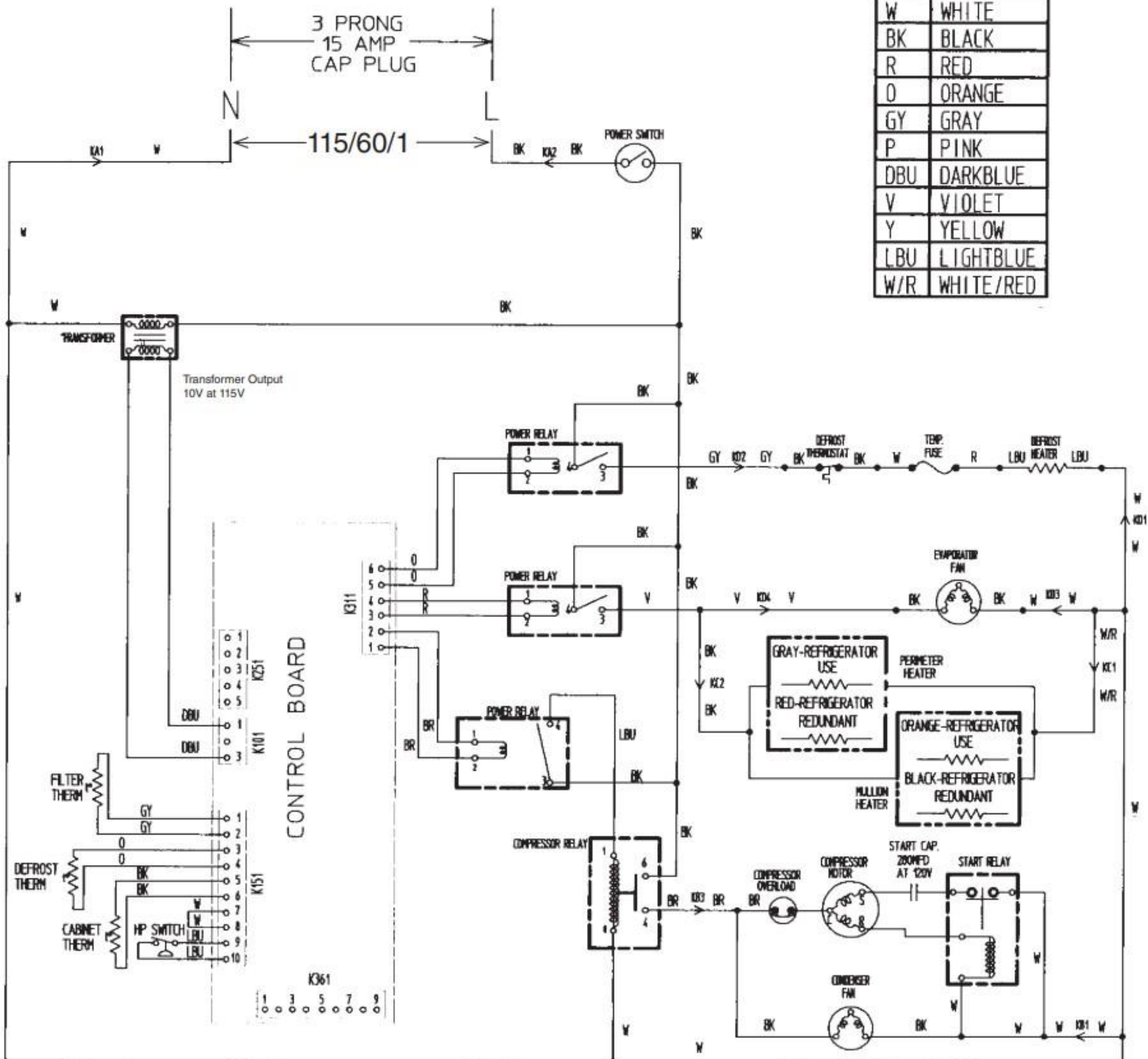

## CONTROL BOARD

K361  
1 3 5 7 9

3 PRONG  
15 AMP  
CAP PLUG

N

115/60/1

WIRE COLOR CODE

BR	BROWN
W	WHITE
BK	BLACK
R	RED
O	ORANGE
GY	GRAY
P	PINK
DBU	DARKBLUE
V	VIOLET
Y	YELLOW
LBU	LIGHTBLUE
W/R	WHITE/RED

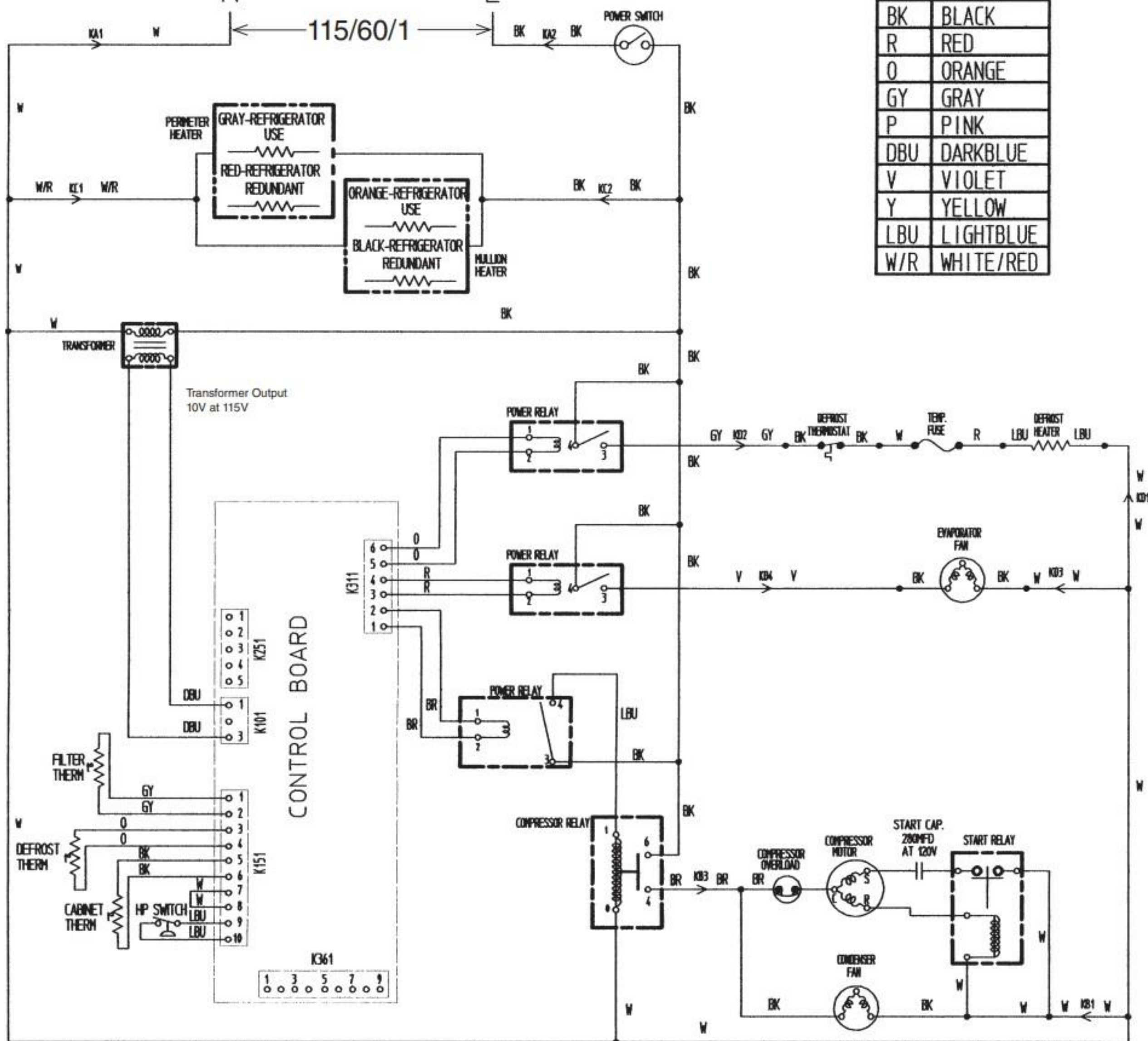

PERIMETER HEATER

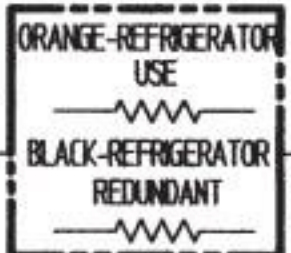
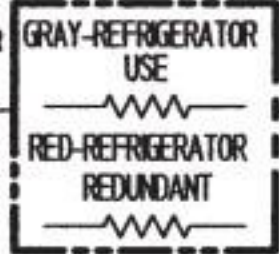

MULLION HEATER

Transformer Output  
10V at 115V

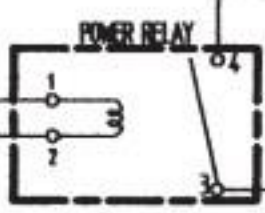
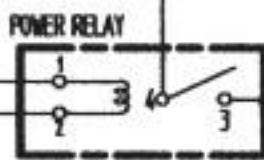
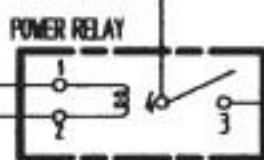

START CAP.  
200MFD  
AT 120V

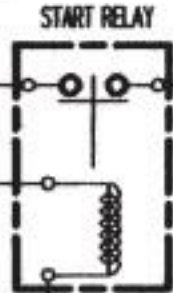

EVAPORATOR FAN

DEFROST THERMOSTAT

TEMP. FUSE

DEFROST HEATER

TRANSFORMER

FILTER THERM

DEFROST THERM

CABINET THERM

HP SWITCH

CONTROL BOARD

K361

K251

K101

K151

K311

POWER RELAY

POWER RELAY

POWER RELAY

COMPRESSOR RELAY

COMPRESSOR OVERLOAD

COMPRESSOR MOTOR

START CAP.  
200MFD  
AT 120V

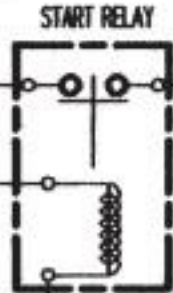

EVAPORATOR FAN

DEFROST THERMOSTAT

TEMP. FUSE

DEFROST HEATER

TRANSFORMER

FILTER THERM

DEFROST THERM

CABINET THERM

HP SWITCH

CONTROL BOARD

K361

K251

K101

K151

K311

POWER RELAY

POWER RELAY

POWER RELAY

COMPRESSOR RELAY

COMPRESSOR OVERLOAD

COMPRESSOR MOTOR

START CAP.  
200MFD  
AT 120V

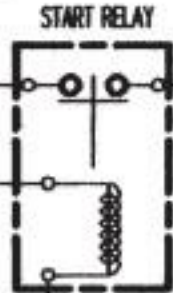

EVAPORATOR FAN

DEFROST THERMOSTAT

TEMP. FUSE

DEFROST HEATER

TRANSFORMER

FILTER THERM

DEFROST THERM

CABINET THERM

HP SWITCH

CONTROL BOARD

K361

K251

K101

K151

K311

POWER RELAY

POWER RELAY

POWER RELAY

COMPRESSOR RELAY

COMPRESSOR OVERLOAD

COMPRESSOR MOTOR

START CAP.  
200MFD  
AT 120V

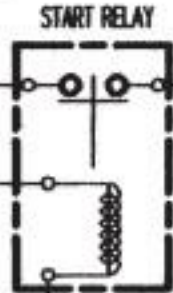

EVAPORATOR FAN

DEFROST THERMOSTAT

TEMP. FUSE

DEFROST HEATER

TRANSFORMER

FILTER THERM

DEFROST THERM

CABINET THERM

HP SWITCH

CONTROL BOARD

K361

K251

K101

K151

K311

POWER RELAY

POWER RELAY

POWER RELAY

COMPRESSOR RELAY

COMPRESSOR OVERLOAD

COMPRESSOR MOTOR

START CAP.  
200MFD  
AT 120V

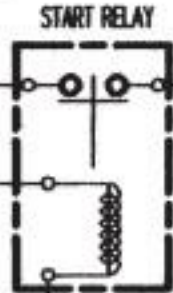

EVAPORATOR FAN

DEFROST THERMOSTAT

TEMP. FUSE

DEFROST HEATER

TRANSFORMER

FILTER THERM

DEFROST THERM

CABINET THERM

HP SWITCH

CONTROL BOARD

K361

K251

K101

K151

K311

POWER RELAY

POWER RELAY

POWER RELAY

COMPRESSOR RELAY

COMPRESSOR OVERLOAD

COMPRESSOR MOTOR

START CAP.  
200MFD  
AT 120V

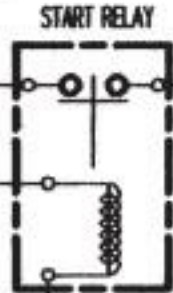

EVAPORATOR FAN

DEFROST THERMOSTAT

TEMP. FUSE

DEFROST HEATER

TRANSFORMER

FILTER THERM

DEFROST THERM

CABINET THERM

HP SWITCH

CONTROL BOARD

K361

K251

K101

K151

K311

POWER RELAY

POWER RELAY

POWER RELAY

COMPRESSOR RELAY

COMPRESSOR OVERLOAD

COMPRESSOR MOTOR

START CAP.  
200MFD  
AT 120V

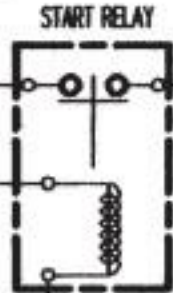

EVAPORATOR FAN

DEFROST THERMOSTAT

TEMP. FUSE

DEFROST HEATER

TRANSFORMER

FILTER THERM

DEFROST THERM

CABINET THERM

HP SWITCH

CONTROL BOARD

K361

K251

K101

K151

K311

POWER RELAY

POWER RELAY

POWER RELAY

COMPRESSOR RELAY

COMPRESSOR OVERLOAD

COMPRESSOR MOTOR

START CAP.  
200MFD  
AT 120V

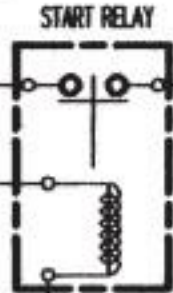

EVAPORATOR FAN

DEFROST THERMOSTAT

TEMP. FUSE

DEFROST HEATER

TRANSFORMER

FILTER THERM

DEFROST THERM

CABINET THERM

HP SWITCH

CONTROL BOARD

K361

K251

K101

K151

K311

POWER RELAY

POWER RELAY

POWER RELAY

COMPRESSOR RELAY

COMPRESSOR OVERLOAD

COMPRESSOR MOTOR

START CAP.  
200MFD  
AT 120V

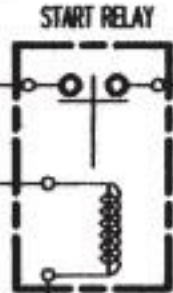

EVAPORATOR FAN

DEFROST THERMOSTAT

TEMP. FUSE

DEFROST HEATER

TRANSFORMER

FILTER THERM

DEFROST THERM

CABINET THERM

HP SWITCH

CONTROL BOARD

K361

K251

K101

K151

K311

POWER RELAY

POWER RELAY

POWER RELAY

COMPRESSOR RELAY

COMPRESSOR OVERLOAD

COMPRESSOR MOTOR

START CAP.  
200MFD  
AT 120V

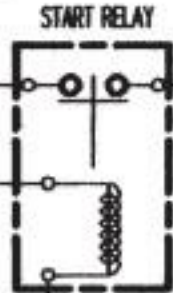

EVAPORATOR FAN

DEFROST THERMOSTAT

TEMP. FUSE

DEFROST HEATER

TRANSFORMER

FILTER THERM

DEFROST THERM

CABINET THERM

HP SWITCH

CONTROL BOARD

K361

K251

K101

K151

K311

POWER RELAY

POWER RELAY

POWER RELAY

COMPRESSOR RELAY

COMPRESSOR OVERLOAD

COMPRESSOR MOTOR

START CAP.  
200MFD  
AT 120V

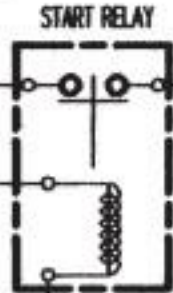

EVAPORATOR FAN

DEFROST THERMOSTAT

TEMP. FUSE

DEFROST HEATER

TRANSFORMER

FILTER THERM

DEFROST THERM

CABINET THERM

HP SWITCH

CONTROL BOARD

K361

K251

K101

K151

K311

POWER RELAY

POWER RELAY

POWER RELAY

COMPRESSOR RELAY

COMPRESSOR OVERLOAD

COMPRESSOR MOTOR

START CAP.  
200MFD  
AT 120V

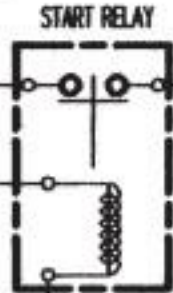

EVAPORATOR FAN

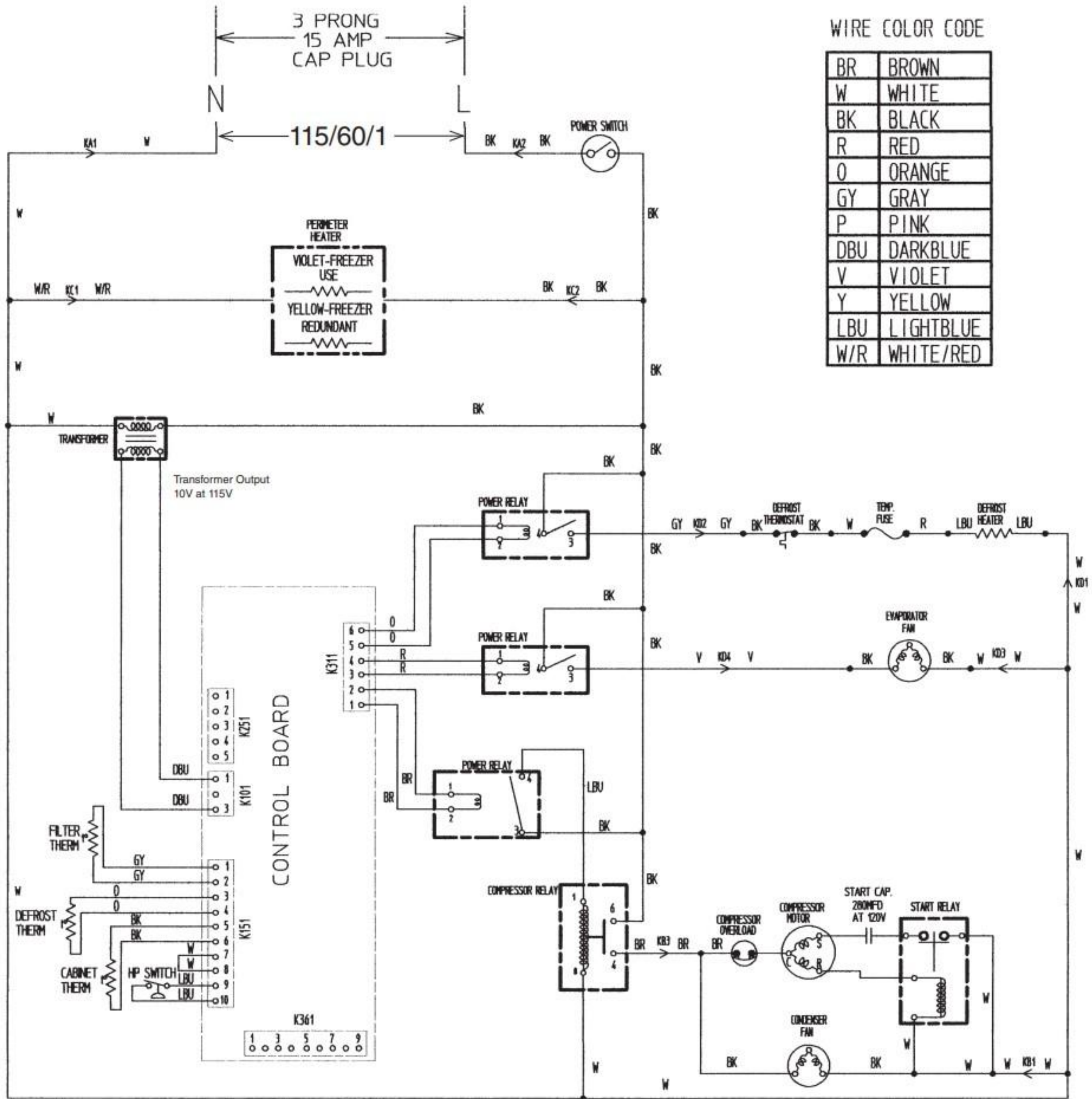

WIRE COLOR CODE

BR	BROWN
W	WHITE
BK	BLACK
R	RED
O	ORANGE
GY	GRAY
P	PINK
DBU	DARKBLUE
V	VIOLET
Y	YELLOW
LBU	LIGHTBLUE
W/R	WHITE/RED

# WIRE COLOR CODE

BR	BROWN
W	WHITE
BK	BLACK
R	RED
O	ORANGE
GY	GRAY
P	PINK
DBU	DARKBLUE
V	VIOLET
Y	YELLOW
LBU	LIGHTBLUE
W/R	WHITE/RED

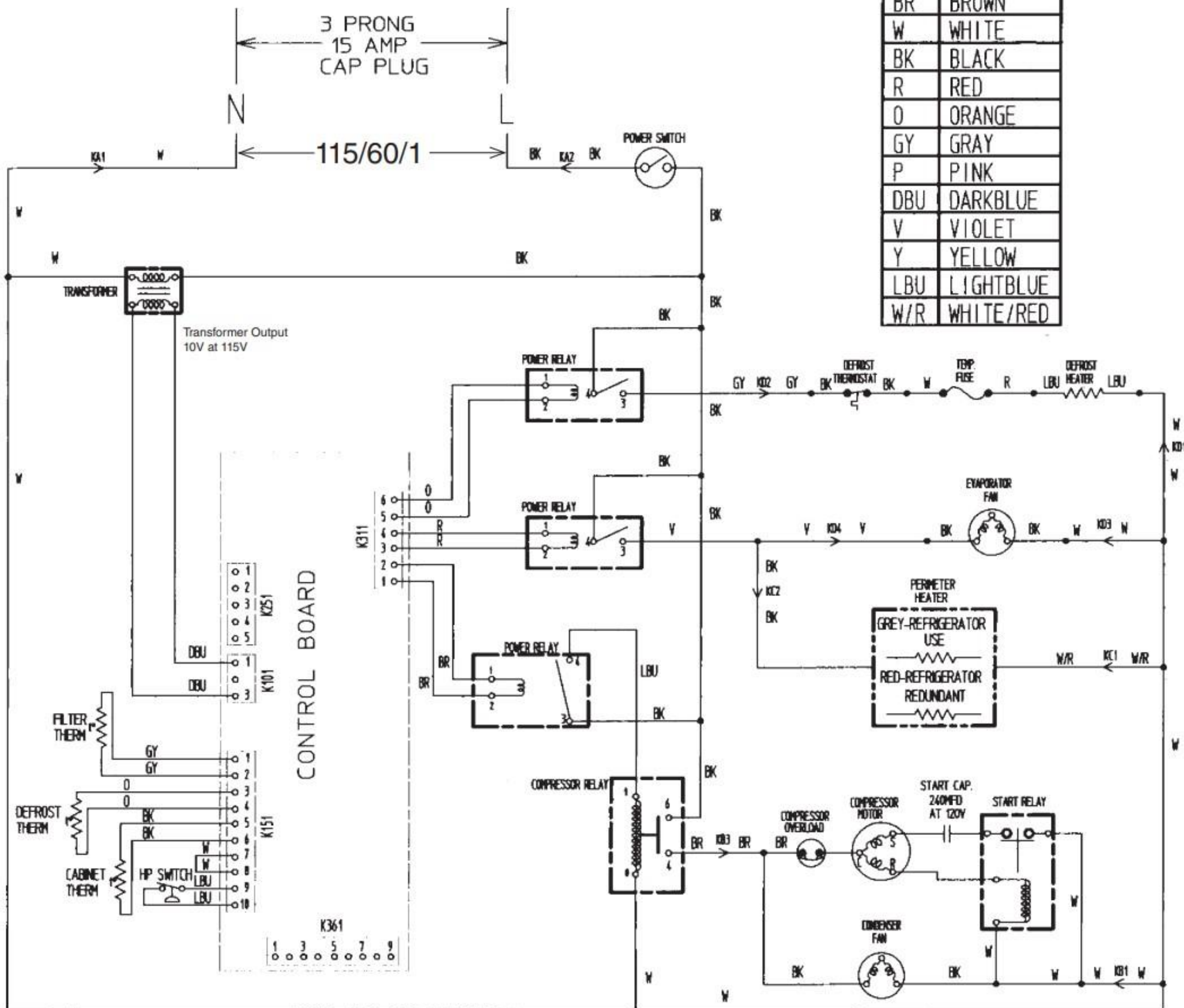

## CONTROL BOARD



3 PRONG  
15 AMP  
CAP PLUG

N

115/60/1

WIRE COLOR CODE

BR	BROWN
W	WHITE
BK	BLACK
R	RED
O	ORANGE
GY	GRAY
P	PINK
DBU	DARKBLUE
V	VIOLET
Y	YELLOW
LBU	LIGHTBLUE
W/R	WHITE/RED

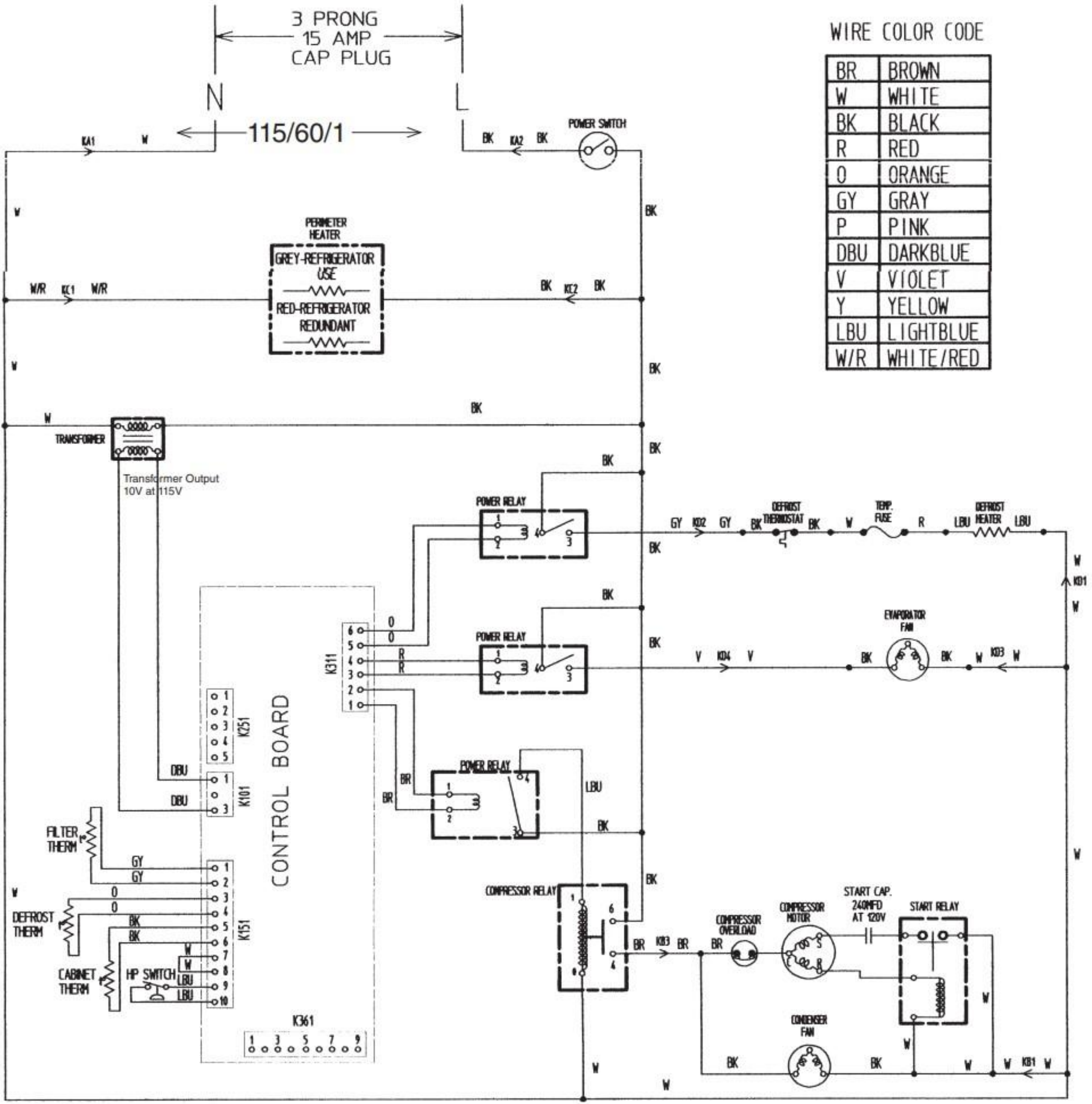

CONTROL BOARD

Transformer Output  
10V at 115V

START CAP.  
240MFD  
AT 120V

COMPRESSOR  
OVERLOAD

COMPRESSOR  
MOTOR

START RELAY

CONDENSER  
FAN

EVAPORATOR  
FAN

DEFROST  
THERMOSTAT

DEFROST  
HEATER

POWER RELAY

POWER RELAY

POWER RELAY

COMPRESSOR RELAY

FILTER  
THERM

DEFROST  
THERM

CABINET  
THERM

HP SWITCH

K251

K101

K151

K361

K311

KE2

KA2

KA1

KD2

KD1

KD4

KD3

KB3

KB1

KE1

KA2

KA1

KB3

KB1

KB1

KB1

KB1

KB1

KB1

KB1

KB1

KB1

KB1

KB1

KB1

KB1

KB1

KB1

KB1

KB1

KB1

KB1

KB1

KB1

KB1

KB1

KB1

KB1

KB1

KB1

KB1

KB1

KB1

KB1

KB1

KB1

KB1

KB1

KB1

KB1

KB1

KB1

KB1

KB1

KB1

KB1

KB1

KB1

KB1

KB1

KB1

KB1

KB1

KB1

KB1

KB1

KB1

KB1

KB1

KB1

KB1

KB1

KB1

KB1

KB1

KB1

KB1

KB1

KB1

KB1

KB1

KB1

KB1

KB1

KB1

KB1

KB1

KB1

KB1

KB1

KB1

KB1

KB1

KB1

KB1

KB1

KB1

KB1

KB1

KB1

KB1

KB1

KB1

KB1

KB1

KB1

KB1

KB1

KB1

KB1

KB1

KB1

KB1

KB1

KB1

KB1

KB1

KB1

KB1

KB1

KB1

KB1

KB1

KB1

KB1

KB1

KB1

KB1

KB1

KB1

KB1

KB1

KB1

KB1

KB1

KB1

KB1

KB1

KB1

KB1

KB1

KB1

KB1

KB1

KB1

KB1

KB1

KB1

KB1

KB1

KB1

KB1

KB1

KB1

KB1

KB1

KB1

KB1

KB1

KB1

KB1

KB1

KB1

KB1

KB1

KB1

KB1

KB1

KB1

KB1

KB1

KB1

KB1

KB1

KB1

KB1

KB1

KB1

KB1

KB1

KB1

KB1

KB1

KB1

KB1

KB1

KB1

KB1

KB1

KB1

KB1

KB1

KB1

KB1

KB1

KB1

KB1

KB1

KB1

KB1

KB1

KB1

KB1

KB1

KB1

KB1

KB1

KB1

KB1

KB1

KB1

KB1

KB1

KB1

KB1

KB1

KB1

KB1

KB1

KB1

KB1

KB1

KB1

KB1

KB1

KB1

KB1

KB1

KB1

KB1

KB1

KB1

KB1

KB1

KB1

KB1

KB1

KB1

KB1

KB1

KB1

KB1

KB1

KB1

KB1

KB1

KB1

KB1

KB1

KB1

KB1

KB1

KB1

KB1

KB1

KB1

KB1

KB1

KB1

KB1

KB1

KB1

KB1

KB1

KB1

KB1

KB1

KB1

KB1

KB1

KB1

KB1

KB1

KB1

KB1

KB1

KB1