

manual

strada mp

Progressive control of water flow and pressure via a mechanical internal valve, thus allowing controlled pre-infusion.

La Marzocco's classic paddle interface, manually operated by the Barista.

With dedicated coffee boilers and pressure gauges for each brew group, the Barista benefits by having real time coffee boiler pressure throughout the extraction.



la marzocco

handmade in florence

strada mp

Operating Manual V1.1 - 11/2014



la marzocco

handmade in florence

Chapters

1. General Warnings and Safety Specifications	page 3
2. Definition of Models	page 5
3. Installation	page 8
4. Operating the Espresso Machine and Preparing Coffee	page 11
5. Preparing Other Hot Drinks.	page 14
6. Preventative Maintenance and Weekly Cleaning	page 15
7. De-commissioning and Demolition	page 16
8. Software Programming Manual	page 17

La Marzocco S.r.l.

Via La Torre 14/H
Località La Torre
50038 Scarperia e San Piero
(Firenze) - ITALIA

www.lamarzocco.com
info@lamarzocco.com

T: +39 055 849 191
F: +39 055 849 1990

EN

certifications available:



1. General Warnings and Safety Specifications

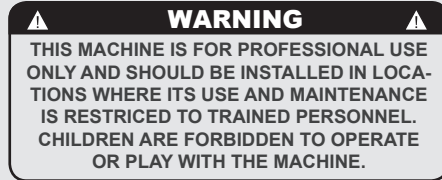

1) This operating manual is an integral and essential part of the product and must be supplied to users. Users are asked to read the enclosed warnings and cautions carefully, as they provide valuable information concerning safety during installation, operation and maintenance. This manual must be kept in a safe place and be available for consultation to new and experienced users alike.

2) Ensure product integrity by inspecting the packaging, making sure it presents no signs of damage which might have affected the enclosed machine.

3) Check the machine's integrity after having carefully removed the packaging.

Note:

In case of doubt, do not go on any further and contact your dealer or retailer immediately. They will send out specialized personnel authorized to perform service on the espresso machine.

4) Packaging (boxes, plastic bags, foam parts and whatever else) must not be left around within easy reach of children, due to the potential danger it represents, nor be discarded in the environment.

5) Check to see that data on the rating plate corresponds to those of the main electrical supply which the machine will be hooked up to.

6) Installation must be performed according to local electrical and plumbing codes and regulations. Installation must also comply to manufacturer instructions, and must be performed by qualified and authorized personnel.

7) Incorrect installation may cause injury/ damage to people, animals or objects, for which the manufacturer shall not be held responsible.

8) Safe electrical operation of this device will be achieved only when the connection to the power outlet has been completed correctly and in observance of all local, national, and international electrical codes and safety regulations, and particularly by grounding the unit. Make sure grounding has been done properly as it represents a fundamental

safety requirement. Ensure qualified personnel check such connection.

9) Furthermore, you must ensure that the capacity of the available electrical system is suitable for the maximum power consumption indicated on the espresso machine.

10) We do not recommend using adapters, multiple plugs and/or extension cords. If you cannot avoid using them, make sure that they are exclusively of the kind which conforms to local, national, and international electrical codes and safety regulations, being careful not to exceed the power and current ratings indicated on such adapters and extension cords.

11) This device must be used exclusively for the functions it has been designed and built for. Any other application is inappropriate and dangerous.

The manufacturer shall not be held responsible for any damages caused by improper and/or irrational use.

12) Using any electrical device requires that certain fundamental rules be observed. In particular:

- do not touch the device with wet or humid hands and feet;

- do not use the device while having no shoes on your feet;
- do not use extension cords in bath or shower rooms;
- do not unplug the device from the power outlet by pulling on the power supply cable;
- do not expose the device to atmospheric agents (rain, sun, etc.);
- do not allow children or untrained personnel to use this device.

13) Before carrying out any maintenance and/or cleaning operation, turn the main switch, which is located on the front left of the machine, to the “0” or OFF position, and disconnect the machine from the electrical network by unplugging the cord or by switching off the relative circuit breaker. For any cleaning operation, follow the instructions contained in this manual only.

14) In case the machine is operating in a faulty manner or breaks down, disconnect it from the electrical network (as described in the preceding point) and close the water supply valve. Do not attempt to repair it. Contact a qualified and authorized professional to perform any repair. Any repairs must be performed exclusively by the manufacturer or by an authorized centre using only original parts. Non compliance with the above could compromise the safe operation of the machine.

15) You should plan to make use of a specific connector during installation, as required by local, national, and international electrical codes and regulations.

16) In order to avoid dangerous overheating problems, it is recommended

that the power supply cable be fully unfurled.

17) Do not obstruct air intake and exhaust grilles and, in particular, do not cover the cup warmer tray with cloths or other items.

18) The machine’s power supply cable must not be replaced by users. In case the power supply cable becomes damaged, shut off the machine and disconnect the machine from the electrical network by switching off the relative circuit breaker and close off the water supply; to replace the power supply cord, contact qualified professionals only.

▲ WARNING ▲
THIS EQUIPMENT MUST BE INSTALLED TO COMPLY WITH THE APPLICABLE FEDERAL, STATE, OR LOCAL PLUMBING CODES

2. Definition of Model

This operating manual refers exclusively to the below model, of our own manufacture:
Strada 3 group Mechanical Paddle: 3MP

1) Common Dimensions, Weights, and Features

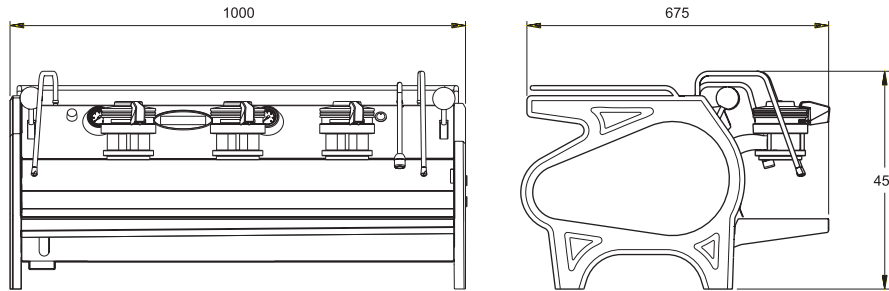

••Weight: Kg. 90

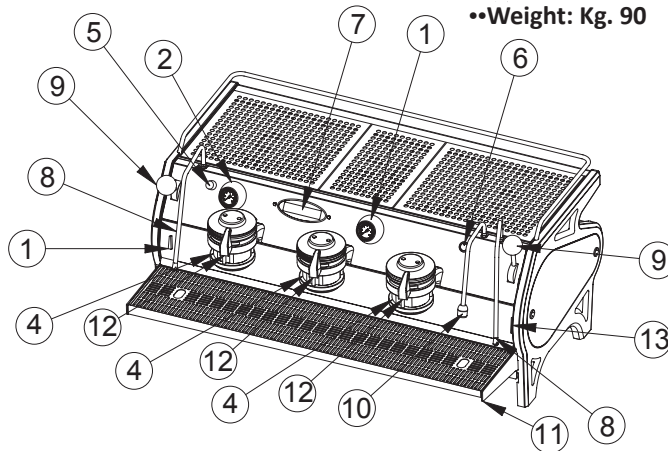

Legend

- 1 Main Switch
- 2 Pressure Gauge (Steam Water)
- 3 Pressure Gauge (Brew Water)
- 4 Brew Groups
- 5 Encoder
- 6 Hot Water Switch
- 7 Digital Display
- 8 Steam Wand
- 9 Steam Knob
- 10 Hot Water Wand
- 11 Removable Drain Tray
- 12 Manual Brew Paddle Lever
- 13 Hot Water Mix Valve

For additional information on electronics, and software programming, please see the section entitled Software Programming.

1) General Description

The machine is built in a 3 group version and is essentially composed of the following parts:

- 1) Steam Boiler (produces steam and hot water)
- 2) 3 Coffee (“saturation”) boilers
- 3) Brewing groups
- 4) Exterior Cover
- 5) Water pump/s

2) Description of the various parts

• Steam Boiler

The Steam Boiler consists of a cylindrical tank made of AISI 300 series stainless steel. Each unit is subject to a hydraulic test, at a pressure of 6 bar, and has an operating pressure of 1.3-1.5 bar. The following is a list of effective volumes and power ratings according to the number of groups installed:

3 groups 11 liters 4000 Watts

Covers are installed at either end of the cylindrical tank and on one of them there is housing for the water heating element, which allows the steam boiler to reach operating pressure within approximately 25 minutes. Operating pressure is maintained by temperature probe. The steam boiler has various fittings used for safety devices, for supplying hot water and steam, and for the heating element.

• Coffee Boiler

The Coffee Boiler consists of a cylindrical tank made of AISI 300 series stainless steel. Each unit is subject to a hydraulic test, at a pressure of 18 bar, and has an operating pressure of 9 bar. The following is a list of effective volume and power ratings according to the

number of groups installed:

3 groups 3 x 1,3 liters 3 x 800 Watts

Covers are installed at either end of the cylindrical tank and on one of them there is housing for the water heating elements. The temperature of the coffee boiler is maintained by an electronic temperature controller (PID capable) with an accuracy of 0.2°C. The brewing groups are installed on the boiler.

• Brewing Groups

They consist of precision casting made of stainless steel. The brewing group accepts the portafilter used to hold the ground coffee; the water flows through the brewing group, through the portafilter basket, through the portafilter spout, and into the cup(s) after brewing has been activated.

MODEL/SERIES	GROUP	V/Hz	RATED POWER (2xpumps)	RATED INPUT (A)	COFFEE BOILER WATTAGE	STEAM BOILER WATTAGE	TOTAL WATTAGE (2xpumps)	POWER CORD SIZE (mm ²)
STRADA	3GR	AC220V/ 50Hz	6700W	31A	800W (EACH)	4000W	6700W	3 WIRES X 6mm ²
POWER CORD:								
3 X WIRES	1 X BLUE	NEUTRAL						
	1 X BROWN	PHASE						
	1 X YELLOW & GREEN	GROUND						

- **Exterior Cover**

It consists of a stainless sheet steel body. The structure has been the object of specific studies to provide good aesthetics, lower ergonomic costs for the operator and reduce the chance of damage to a minimum.

- **Water Pump**

The water pump is a differential pressure, "positive-displacement" type installed on the water supply tubing and is set-up to operate anytime the coffee groups are activated, and through an electric level gauge whenever the steam boiler needs to be replenished.

- **Sound Pressure**

The weighted sound pressure level of the machine is lower than 70dBA.

CONSTRUCTION DETAILS

They consist essentially of 2 small boilers, of which:

- 1) Coffee Boiler (hot water generator for brewing coffee)
- 2) Steam Boiler (steam generator for producing steam and hot water for making tea and other hot drinks)

1) Description of the Coffee Boiler (C.C.)

Composed of an AISI 300 series stainless steel tube.

Heating is accomplished through an immersion-type plated heating element.

- Operating temperature 95°C (adjustable), controlled automatically by an electronic temperature controller with an accuracy of 0.2 °C. Operating pressure of 9 bar, developed mechanically by a special

positive-displacement pump which is activated automatically every time coffee is brewed.

- Pressure is displayed through a pressure gauge with a scale from 0 to 15 bar.
- Safety device, based on an expansion type mechanical valve, with counteracting spring adjusted to 12 bar.
- Testing:
- Hydraulic test at 18 bar performed on ready-to-use small boilers, at our factory;



3. Installation

2) Description of the Steam Boiler (C.V.)

Composed of AISI 300 series stainless steel tube.

Heating is accomplished through an immersion-type plated heating element.

- Operating pressure of 1.3-1.5 bar, controlled automatically through a pressure switch or a temperature probe, adjusted to open the heating element supply circuit at 1.5 bar and close it at 1.3 bar.
- The pressure is displayed by means of a pressure gauge with a scale of 0 to 2 bar.
- Safety device, based on an expansion type mechanical valve, with counter-acting spring adjusted to 1.8 bar.
- Testing:
 - a) hydraulic test at 4.5 bar performed on ready-to-use small boilers, at our factory;

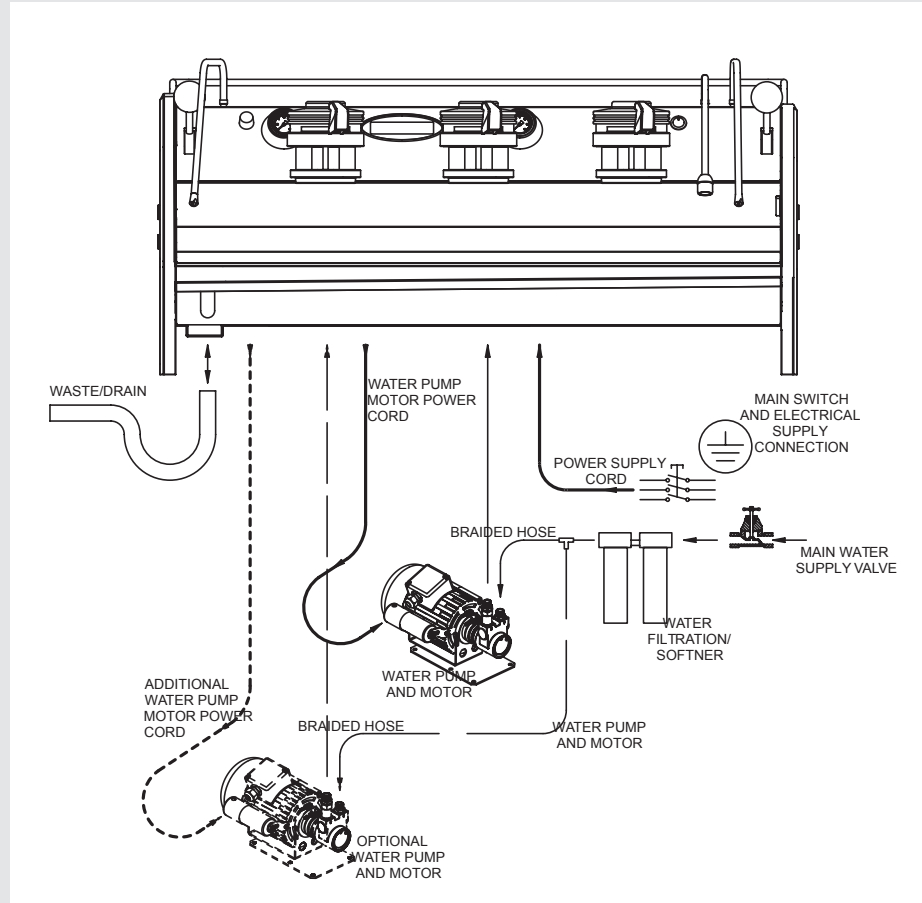

WARNING

THE COFFEE BOILER AND STEAM BOILER CONTAIN WATER AT ELEVATED TEMPERATURE. WATER TEMPERATURE OVER 125° F / 52° C CAN INSTANTLY CAUSE SEVERE BURNS OR DEATH FROM SCALDING. (COFFEE BOILER 200° F / 93.3° C - STEAM BOILER 260° F / 127° C)

1) Accessories



Check the package to make sure that the following accessories are included:

- 1 x SINGLE and 3 x DOUBLE portafilters
- 2 x SINGLE and 4 x DOUBLE filters
- 1 x tamper
- 1 x blind filter
- 1 x cleaning detergent
- 3 x stainless steel braided hose for water connections
- 1 x 1,5 mt of reinforced plastic tubing for drainage
- 1 x hose clamp
- 1 x TEE Fitting

In order to proceed with installation, it is necessary that the following are available:

- a) Pipes carrying drinking water with a 3/8" G (BSP) end connection.
- b) Electrical Supply according to the specification of the espresso machine purchased: 200/220/380/VAC - 50/60Hz electrical connection with ground, protected socket and approved circuit

breaker.

c) Indirect waste water drain system.

NOTE

- *The drinking water stopcock and the terminal switches for the electrical system need to be located in the most convenient position for the operator to access them easily and quickly.*
- *The machine should be placed on a flat counter and must be placed in settings with the following temperatures: Minimum room temperature: 5°C Maximum room temperature: 32°C*
- *If the machine has been temporarily housed in settings with a room temperature of less than 0°C, the machine must be placed in a warmer environment in order to gradually defrost the hydraulic system prior to use.*
- *Water pressure supply must be between 2 and 6 bar.*

2) Water Supply Connection

Connect the inlet of the water filter/softener to the drinking water supply using one of the supplied stainless steel braided hoses. Before connecting the espresso machine to the filter/softener, flush the water supply line and the filtration system

in order to eliminate any residual particles which could otherwise get stuck in taps or valves thus preventing them from working properly.

Connect the water supply connection of the espresso machine to the water pump outlet using one of the supplied stainless steel braided hoses. Then connect the water pump inlet to the water filter/softener outlet.

NOTE: *The water pump is a differential pressure, volumetric pump and has been designed to be used exclusively with cold water. Make sure that water is always present while the pump is operating, otherwise air can be introduced into the brew boiler causing an undesirable condition.*



3) Electrical Connections

a) Power Supply Cord

This is the main power supply cable that provides power to the entire espresso machine. There are different types of cable based upon the electrical requirements of the espresso machine purchased.



CAUTION



BEFORE MAKING ANY ELECTRICAL CONNECTIONS MAKE SURE THAT THE 2 STRAIN RELIEF CONNECTORS ARE FIRMLY SECURED TO THE BODY OF THE MACHINE IN ORDER TO PREVENT INADVERTENT STRESS ON THE POWER CABLES.

b) Water Pump Motor Power Cord

This is the power supply for the water pump motor. The internal electronics will switch the pump motor on when needed.

3-core cable with 1.5 mm² cross section (CE) or 3-core AWG 16 (for UL version) secured to espresso machine via a strain relief connector.



WARNING

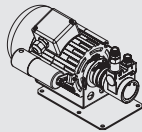

THE MOTOR PUMP MUST BE SITUATED CLOSE TO THE MACHINE IN AN ACCESSIBLE PLACE FOR MAINTENANCE BUT NOT FOR ACCIDENTAL INTERFERENCE AND WHERE THERE IS AN OPTIMAL AIR CIRCULATION

4) Waste Water Drain Connection

The espresso machine drain is to be connected by means of the included reinforced plastic tubing. Connect one end of the reinforced plastic tubing to the drain hose connection on the left side of the espresso machine. Secure with included hose clamp.

Connect the other end to a suitable waste water collection system.

In case such a system is not available, drained liquids may be collected in a suitable bucket and any necessary drain pipe extensions should be made using steel-lined PVC tubing and suitable hose clamps.



WARNING



U.S.A. AND CANADA ONLY
DO NOT CONNECT TO A CIRCUIT OPERATING AT MORE THAN 150 V TO GROUND



WARNING



THE MANUFACTURER DECLINES ANY RESPONSIBILITY FOR ANY EVENT LEADING TO LIABILITY SUITS WHENEVER GROUNDING HAS NOT BEEN COMPLETED ACCORDING TO CURRENT LOCAL, NATIONAL AND INTERNATIONAL REGULATIONS AND ELECTRICAL CODES, AND/OR IN LACK OF PROPERLY CONNECTED ELECTRICAL PARTS.

4. Operating the Espresso Machine and Preparing Coffee

1) Starting the Espresso Machine Filling the Boilers with Water:

Once the installation procedures have been completed, it is necessary to fill the boiler tanks with water. Complete the following procedure to properly fill the boiler tanks:

• Coffee Boiler

The water flows inside the coffee boilers directly, as soon as the water system and water filter/softener valves are opened. Since the inflow of water will compress the air in the boiler, it will be necessary to remove or “bleed” the air from the coffee boilers. All air must be removed in order to completely “saturate” the coffee boiler/group assemblies.

To remove the air from the boiler, or “bleed the groups”, it will be necessary to remove the plastic cap and the handle from the top of the group.

Loosen the bleed screws one at a time to allow air to escape until water flows from below the screw head. Tighten the screw to stop the water from flowing. Over tightening can cause damage to the sealing washer and the group cover. Repeat this procedure on all groups.

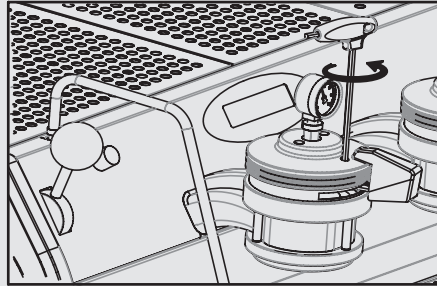

• Steam Boiler

Turn the main switch to position “1” or ON, then push the encoder knob for three seconds and the automatic steam boiler level function will be switched on, activating the auto-fill solenoid valve and the motor pump. This will fill the steam boiler to a predetermined level and will shut off when full.

Note: Air inside the steam boiler may build up pressure (which may be detected through the pressure gauge). Once the pump stops, check the display, the message “Coffee Boiler Filled?” should be displayed. Push the Encoder Knob to confirm that the preceding procedures are complete. The installation is now complete and the espresso machine should be heating to operating temperatures.

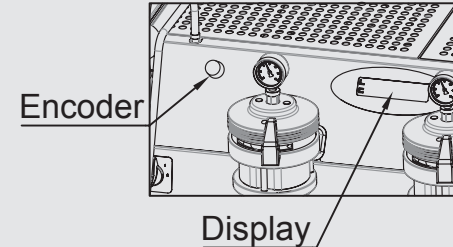

2) Waiting for the Espresso Machine to Heat to Operating Temperature

During this time, it may happen that the pointer of the coffee boiler pressure reaches as high as 14-15 bar.

This may happen anytime that the heating element is in the “on” condition. In this case, it is necessary to adjust the expansion valve in such a way that the pressure never exceeds 11-12 bar. In normal operating conditions, the coffee boiler pressure gauges can read anywhere from 0-12 bar. When brewing, the pressure should be set to 9 bar. When the steam boiler reaches operating temperature, the light on the Tea dispense button will switch on.

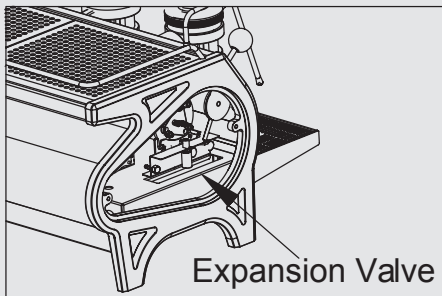

3) Installing the Portafilters

Install the portafilter(s) by inserting them into the group and rotate the handle from left to right. When the portafilters are inserted properly, you can press any of the brew buttons to start the flow of water through the portafilter. You should allow hot water to pass through the portafilter(s) for a few seconds each time, in order to pre-heat the portafilter.

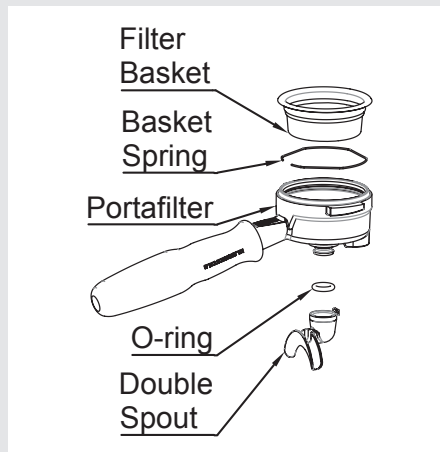

Note: It is important to leave the portafilters installed in the espresso machine when not in use. The portafilter must remain heated for the brew process to function correctly.

4) Brewing Coffee with/out Pre-Infusion

It is now possible to remove one of the portafilters to make an espresso beverage. Place some ground coffee in the filter itself: 1 dose (approximately 7 g) for the small filter, 2 doses (approximately 14 g) for the larger filter.

Press down on the ground coffee with the supplied tamper and install the filter

holder to the bottom of the group. Move the paddle to begin the brewing process. Mechanically control water and pressure flow through an internal valve to obtain superior cup quality traditionally achieved with "lever" machines. Manual pre-infusion allows you to bring out different flavor components which affect the balance and body of the shot, and produce rounder, softer espresso that highlights brightness, sweetness and delicate note.



Note: Some baristas suggest flushing the group with water to remove remaining coffee oil or particles. Some flush after every shot. Experimentation and practice is suggested to establish the best possible procedure for brewing coffee.

5) General Notes for Coffee Preparation

The portafilters must remain heated since they are partially isolated from the group due to the rubber gasket between them. This can be accomplished by leaving the portafilters installed on the machine when

not in use. The portafilters may also be actively heated. This procedure may be carried out by activating one of the brew buttons to flush hot water through the portafilter then turning off the water flow.

Other than the type of coffee blend being used, naturally, the size of the coffee granules is extremely important in the preparation of a good cup of coffee. Ideal grinding can be determined by making various coffees using the amount of ground coffee that you would normally use for each cup (we recommend at least 6g). The most suitable grinding allows coffee to flow gradually from the filter holder spout - neither too slowly, nor too quickly. A general rule is that a double dose should dispense approximately 2 fluid oz. of espresso in approximately 25 seconds.

IMPORTANT

To improve flavor, the temperature of water in the coffee boiler, which has a direct impact on the groups, may eventually be increased or reduced via the digital display (please consult the Software Programming Manual for detailed instructions).

▲ WARNING ▲

DO NOT REMOVE THE PORTAFILTER WHEN ITS REALTIVE GROUP IS BREWING HOT LIQUIDS. THE COFFEE BOILER CONTAINS WATER AT ELEVATED TEMPERATURE. WATER TEMPERATURE OVER 125° F / 52° C CAN INSTANTLY CAUSE SEVERE BURNS OR DEATH FROM SCALDING.

5. Preparing Other Hot Drinks

1) Steaming Milk or Other Liquids

Dip one of the 2 steam wands (part 8, page 5) which are connected to the steam valve, into the liquid to be heated. Turn the steam lever on gradually until steam is released at the end of the wand.

The steam will heat the liquid and raise its temperature.

To avoid severe burns, do not allow any liquid to overflow.

In order to successfully foam milk, please follow these steps:

- Place the pitcher that is partially filled with milk under the steam wand. Open the steam valve and bring the temperature of

the milk to nearly 149/158° F 65/70° C.

- Lower the pitcher so that the wand tip is just below the surface of the milk; at this point, move the container up and down just enough to dip the nozzle end in and out of the milk until you get the right amount of foam. Gradually pour the foamed milk over warm espresso for a fresh cup of cappuccino.

In order to prevent heated liquid from being sucked back into the steam boiler, it is recommended that the steam valve and steam wand be purged by opening the valve for a few seconds to allow steam to escape from the end of the steam

wand. Failure to do so can cause heated liquid to be transferred from the pitcher to the steam boiler (due to a vacuum created by cooling parts). This condition is undesirable and can contaminate the steam boiler.

2) Preparing Tea and Other hot Drinks.

You may dispense hot water by using the fixed nozzle (part 10, page 5). To dispense hot water, press the tea water button.

This button commands hot water delivery. The temperature of the water may be adjusted by adjusting the mixing valve.

6. Preventative Maintenance and Weekly Cleaning

WARNING
THE MACHINE MUST BE INSTALLED SO THAT QUALIFIED TECHNICAL PERSONNEL CAN EASILY ACCESS IT FOR EVENTUAL MAINTENANCE.

CAUTION
THE MACHINE MUST NOT BE DIPPED IN, NOR SPLASHED WITH WATER WHILE CLEANING. FOR CLEANING OPERATIONS, PLEASE FOLLOW THE INSTRUCTIONS LISTED BELOW VERY CAREFULLY.

1) Cleaning groups and drain wells

- Put a tablespoon of detergent powder for coffee machines into the blind filter, supplied with the machine, and attach it on the group to be cleaned.

WARNING
DO NOT REMOVE THE PORTAFILTER WHEN ITS REALTIVE GROUP IS BREWING HOT LIQUIDS. THE COFFEE BOILER CONTAINS WATER AT ELEVATED TEMPERATURE. WATER TEMPERATURE OVER 125° F / 52° C CAN INSTANTLY CAUSE SEVERE BURNS OR DEATH FROM SCALDING.

- Turn the Paddle Valve on and off approximately 10 times (10 seconds intervals) on each group.
- Rinse the group using a normal filter

by running hot water through it several times.

2) Cleaning filters and filter holders

- Put 2 or 3 teaspoons of detergent powder for coffee machines in about 1/2 a litre of VERY HOT water.
- Dip filters and filter holders in the heated solution and leave them fully submerged for about 10 minutes.
- Rinse thoroughly with clean water and run hot water through one group several times with the filters in place.
- Make one cup of coffee and discard in order to remove any unpleasant flavor.

3) Cleaning the drain collector

Remove the drain tray daily and clean. Inspect the drain well also, and wash away any leftover grounds.

4) Cleaning the body

Wipe the stainless steel surfaces with a soft, non abrasive cloth. Do not use any alcohol or solvents whatsoever on painted or decorative parts to avoid damage.

5) Cleaning the hot water and steam nozzles

Steam nozzles must be cleaned immediately after use with a damp cloth and by producing a short burst of steam to prevent the formation of deposits inside

the nozzles, which may alter the flavor of other drinks to be heated. Hot water nozzles must be cleaned periodically with a damp cloth.

6) Cleaning the Diffuser Screen

Due to portafilter discharge operations (subsequent to coffee brewing), a certain amount of coffee grounds may slowly build-up

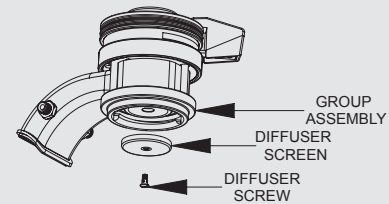

and even partially obstruct the diffuser screen.

To clean it, first unscrew the diffuser screw, then remove the diffuser screen.

Put 2 or 3 teaspoons of cleaning detergent for coffee machines in about 1/2 a litre of water inside a heat-resistant container and heat. Place the diffuser screen(s) and diffuser screw(s) in the solution and leave them fully submerged for about 10 minutes.

Rinse thoroughly with clean water. Install and run hot water through each group

several times with the screen installed.

7) Water Pump

When brewing coffee, and you can adjust pump pressure by turning the by-pass screw clockwise to increase and counter-clockwise to reduce pressure. Adjust pressure only when one or more groups are brewing coffee.

8) Water Filter/Softener

Please see the documentation accompanying the water filter/softener for proper operating and cleaning instructions.

7. De-Commissioning and Demolition

1) De-Commissioning and Demolition

Start by setting the main switch to the “0” or OFF position.

Disconnecting from the power outlet

Disconnect the espresso machine from the electrical network by switching off the associated circuit breaker or circuit protection device. Remove the power supply cord from the power connection. Remove the Pump Motor Power Cord from the water pump motor.

Disconnecting from the water system

Shut off the water supply by closing the specific valve located upstream of the water filter/softener inlet. Disconnect the water pipe at the water filter/softener inlet. Remove the hose connecting the

espresso machine to the water pump. Remove the reinforced plastic tubing on the drain connection.

At this point, the machine may be removed from the bar, being very careful not to drop it or crush your fingers.

The machine is made out of various materials and therefore, if not intended for further service, should be delivered to a recycling center which will select materials to be recycled or discarded.

Current regulations make it illegal to discard the machine by leaving it on public grounds or on any private property.

Recycling notice:

Warning for the protection of the environment.

Old electrical equipment is made of valuable materials, it is not normal domestic waste! We kindly ask that our clients contribute to the protection of the environment and natural resources by delivering this equipment to a recycling center, if such centers are present in any one specific territory.



STRADA MP

Software Programming Manual

Strada Programming Introduction	pag 18
Accessing Programming Mode	pag 20
Description of the Programming Levels	pag 21
Start Up Procedures	pag 24

Strada Programming Introduction

Description

- The Strada espresso machine has a very functional CPU with many programmable settings.
- Additionally, there are many feedback controls to troubleshoot problems that may occur.
- The following is a brief introduction to the controls and display and how they interact with the operator.

Digital Display



The digital display is a backlit screen capable of displaying 2 lines with 16 characters each. The display enables the operator to interact with the espresso machine to change parameter values. The display also provides valuable information to the operator. There are several warnings that can be displayed to alert the operator of an unusual condition or fault. Additionally, simple messages are displayed alerting the operator that an action has been started or that a process needs to begin.

Programming Encoder

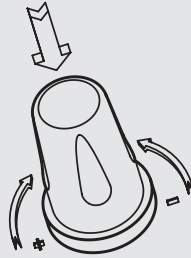

The encoder knob is always located on the left of group one. By turning it to the right it is possible to increase the value. By turning it left, it is possible to decrease the value and by pushing it down, it is possible to scroll through the software menu, enter functions or confirm first installation.

It is possible to turn on/off the Strada coffee machine by pushing and holding the Encoder knob for 3 seconds.

Accessing Programming Mode

Programming Mode



Description

- To change any configurable parameter the operator must first enter the programming mode.
- There are three levels of the programming mode that allow modification to specific parameters, depending on the sequence that is followed

The three programming levels are as follows:

- Barista Level - No Password Necessary. Limited parameters are available.
- Technical Level - Barista level parameters plus additional parameters are available.
- Factory Level - Factory password needed. Barista Level and Technician level parameters plus additional parameters are available.

Description of the Levels

Barista Menu

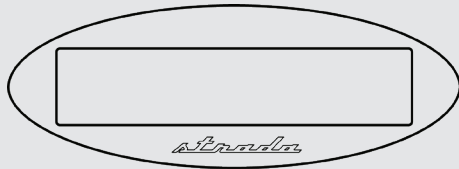

Programming sequence

Operating Procedure: with the coffee machine on, press and hold the encoder knob for 5 seconds and the Barista Level menu will appear.

- Coffee Boiler 1 Switching on/off
- Coffee Boiler 2 Switching on/off
- Coffee Boiler 3 Switching on/off
- Coffee Boiler 1 Temperature
- Coffee Boiler 2 Temperature
- Coffee Boiler 3 Temperature
- Steam Boiler Temperature
- Clock Adjust
- Auto On/Off

Description of the Levels

Technical Menu

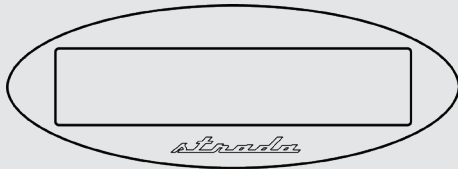

Programming sequence

Operating Procedure: First hold the knob for 3 seconds to achieve the OFF status, then release it and press and hold it again for an additional 5 seconds. The Technician Level menu will appear.

- Language
- Temperature Measurement Units (°F - °C)
- User name
- Coffee Boiler 1 Temperature
- Coffee Boiler 2 Temperature
- Coffee Boiler 3 Temperature
- Steam Boiler Temperature
- Clock Adjust
- Auto On/Off
- Cup Heating
- Pumps Setting for Automatic Fill
- Steam Boiler Automatic Fill
- Pump Setting for Tea Water
- Coffee Boiler 1 Temperature Offset
- Coffee Boiler 2 Temperature Offset
- Coffee Boiler 3 Temperature Offset
- Total Doses
- Filter Alarm

Factory Menu

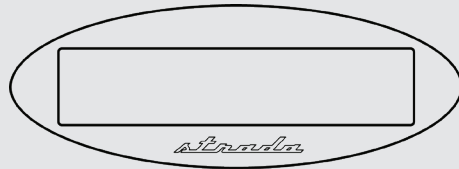

Programming sequence

Operating Procedure: First hold the knob for 3 seconds to achieve the OFF status, then release it and press and hold it again for 15 additional seconds. The Factory Level menu will appear.

- Machine Group Number
- Coffee Boilers Proportional, Integral, derivative (PID) Setting
- Coffee Boilers PID Start
- Coffee Boiler 1 Heating Timeout
- Coffee Boiler 2 Heating Timeout
- Coffee Boiler 3 Heating Timeout
- Steam Boiler Heating Timeout
- Steam Boilers Proportional, Integral, derivative (PID) Setting
- Steam Boiler PID Start
- Steam Boiler Level Probe Sensitivity
- Steam Boiler Level Probe Delay
- Steam Boiler Level Timeout
- Language
- Temperature Measurement Units (°F - °C)
- User Name
- Coffee Boiler 1 Temperature
- Coffee Boiler 2 Temperature
- Coffee Boiler 3 Temperature
- Steam Boiler Temperature
- Clock Adjust
- Auto On/Off
- Cup Heating
- Pumps Setting
- Steam Boiler Automatic Fill
- Pump setting for Tea Water
- Coffee Boiler 1 Temperature Offset
- Coffee Boiler 2 Temperature Offset
- Coffee Boiler 3 Temperature Offset
- Total Doses
- Filter Alarm





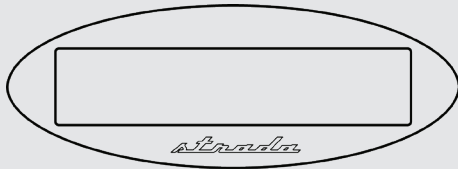

Start Up Procedures

Turning the Espresso Machine On!



Description

- The following is the procedure for turning on the espresso machine.
- Please follow the procedures carefully to avoid any damage.

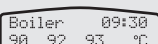
Display	Operating Procedure
	<p>1 Turn the Main Switch to the On position. (ON=1, Off=0)</p> <div style="display: flex; justify-content: center; gap: 20px;"> <div style="text-align: center;">  <p>0 1</p> </div> <div style="text-align: center;">  <p>0 1</p> </div> <div style="text-align: center;">  <p>OFF ON</p> </div> <div style="text-align: center;">  <p>OFF ON</p> </div> </div>
	<p>2 The message at left will be displayed briefly. This message indicates the revision level of the software installed in this espresso machine.</p>
	<p>3 The espresso machine is now ON and information concerning the boiler and heating elements will appear..</p>
	

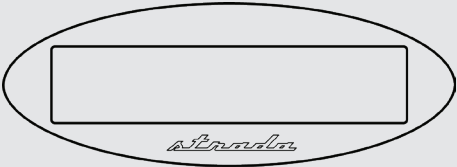

⚠ WARNING ⚠
HAZARDOUS VOLTAGE! DISCONNECT FROM POWER SUPPLY BEFORE SERVICING

Turning the Espresso Machine Off

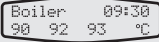

Description

- The following is the procedure for turning off the espresso machine.
- Please follow the procedure carefully to avoid any damage.
- This machine has two off settings. One setting turns off all components of the espresso machine and the other turns off power to the entire espresso machine.

Display	Operating Procedure
 	<ol style="list-style-type: none"> <li data-bbox="379 648 1592 675">1 The following is the procedure for safely turn off the espresso machine. <li data-bbox="379 721 1592 747">2 Press and hold the Encoder Knob for 3 seconds. The display changes to the following: <li data-bbox="379 793 1592 819">3 This is the OFF setting used in normal operating conditions. <li data-bbox="379 865 1592 892">4 The main switch should be turned to the OFF position during servicing or other conditions requiring the OFF position. <div data-bbox="809 939 1183 1023" style="text-align: center;"> </div>

⚠ WARNING ⚠
HAZARDOUS VOLTAGE DISCONNECT FROM POWER SUPPLY BEFORE SERVICING

