



Model LCR7W
7-Spit Rotisserie Oven with Wash System
Installation, Service and Parts Manual

LBC Bakery Equipment, Inc.

6026 31st Ave NE

Tulalip, WA 98271, USA

Phone: 888-RACKOVN (888-722-5686)

Fax: 425-642-8310

Email: service@lcbakery.com

READ FIRST

THIS MANUAL MUST BE RETAINED FOR FUTURE REFERENCE. READ, UNDERSTAND AND FOLLOW THE INSTRUCTIONS AND WARNINGS CONTAINED IN THIS MANUAL.



This LBC Rotisserie was manufactured to rigid standards. The appliance has been tested and is listed by Intertek Testing Services (ETL Semko) and meets applicable safety and sanitation standards.

- A) The **responsibility of the manufacturer** is to supply suitable, comprehensive instructions and recommendations for proper operation and maintenance.
- B) All operations, maintenance and repair of this or any LBC Bakery Equipment appliance must be performed by properly trained and qualified personnel, and all such operations, maintenance and repair must be performed in a diligent manner. It is the **responsibility of the owner/operator** to ensure proper training and diligence of any person coming into contact with either the subject units or the output (product, fumes or otherwise) of the subject units. It is the **responsibility of the owner/operator** to ensure that the subject units are installed and operated in accordance with OSHA Standard 1910.263.
- C) A regular periodic program of cleaning, inspection and maintenance must be established and comprehensive maintenance records maintained. It is the **sole responsibility of the owner/operator** to establish, schedule and enforce the frequency and scope of these programs in keeping with recommended practice and with due consideration given to actual operating conditions.
- D) The appliance must be operated within limits which will not exceed its working limits. It is the **responsibility of the user** to operate this appliance in accordance with the rules and limits described in this manual and the published product specification sheet, and in accordance with the directions and instructions of the owner/operator of the appliance or employer, and in accordance with applicable federal, state and local laws and ordinances.

TABLE of CONTENTS

Read First 2

Specifications 4

Configurations 5

Conditions of Installation 6

Receiving and Unpacking 7

Installation 8

Controller Operation 13

Parts List 14

Notes 19

Wiring Diagram 20

Warranty 22

SPECIFICATIONS

LBC Kitchen Series Electric Rotisserie with Wash System

Model: LCR7W

Installation Requirement

Each unit ships separately. Placing on stand required.

Options and Accessories (Check as Required)

- | | | | |
|-------------------------------------------|------------------------------------------------|--------------------------------------------------|-------------------------------------------------------------------------------------|
| <input type="checkbox"/> Front Door Only | <input type="checkbox"/> Stainless Angle Spits | <input type="checkbox"/> Stainless Carousel | <input type="checkbox"/> Oven Cleaner (carton of 2 ea 2.5 gal bottles) |
| <input type="checkbox"/> Front/Rear Doors | <input type="checkbox"/> Non-Stick Angle Spits | <input type="checkbox"/> Non-stick Carousel | <input type="checkbox"/> Plastic Cap with Hose Attachment (for oven cleaner bottle) |
| <input type="checkbox"/> Rear Door Handle | <input type="checkbox"/> Stainless Fork Spits | <input type="checkbox"/> Chain Restraint Kit | |
| | <input type="checkbox"/> Non-Stick Fork Spits | <input type="checkbox"/> LST7 Stand with Casters | |
| | <input type="checkbox"/> Stainless Baskets | <input type="checkbox"/> MSR7 Mobile Skewer Rack | |
| | <input type="checkbox"/> Non-Stick Baskets | | |

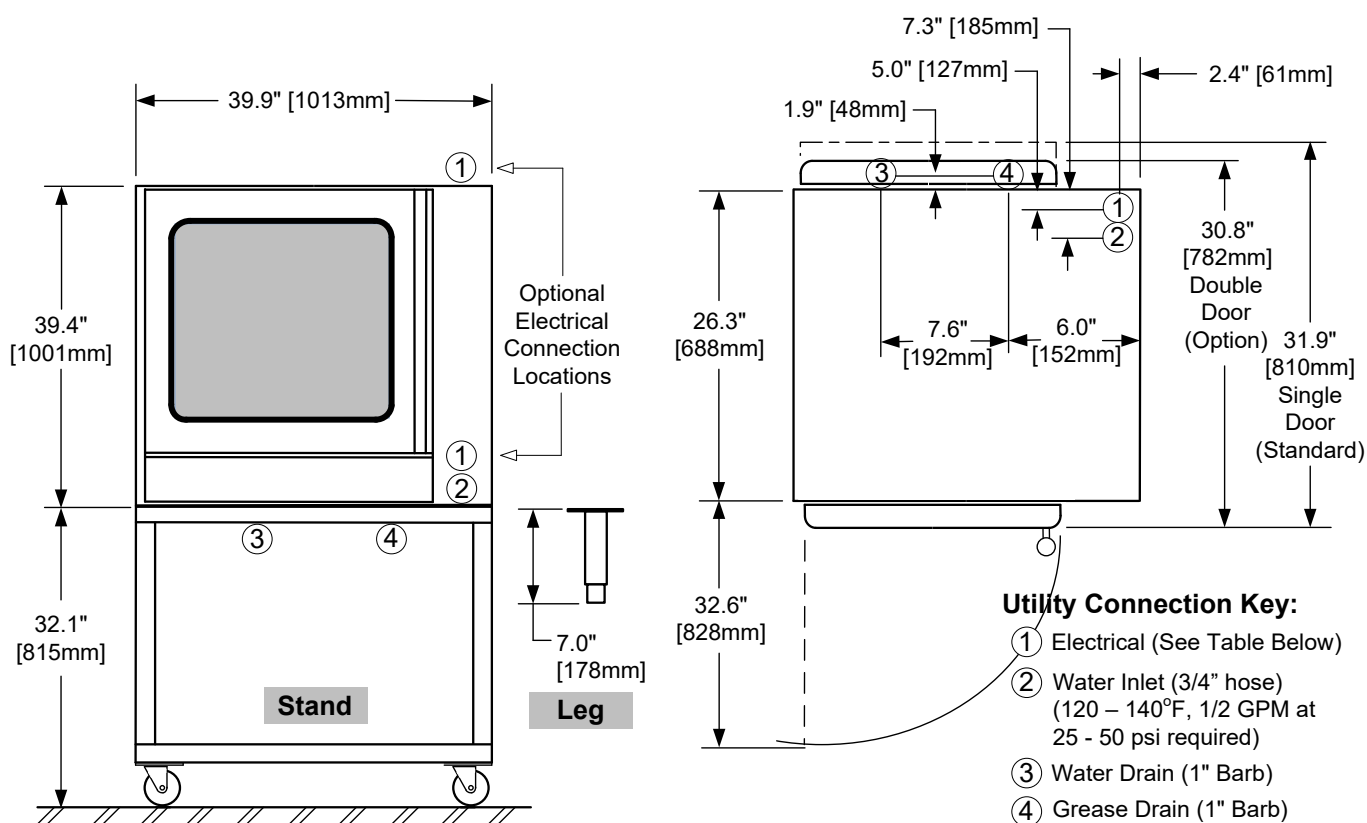

Voltage	kW	Min Circuit Ampacity		Max Breaker Size		Shipping Weight	Freight Class
		1 Phase	3 Phase	1 Phase	3 Phase		
208 VAC	8.0	55	N/A	60	N/A	660 lbs [299 kg]	85
240 VAC	8.0	50	N/A	60	N/A		
208 VAC	9.0	N/A	40	N/A	60		
240 VAC	9.0	N/A	35	N/A	60		

CONFIGURATIONS

Countertop or
Floor Mount

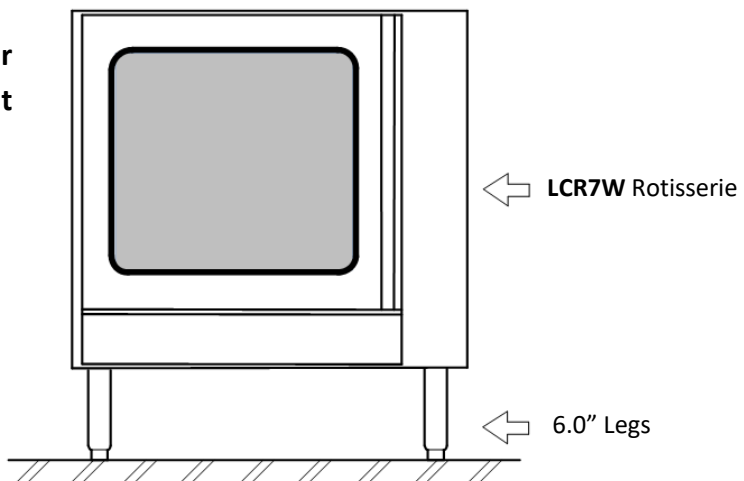

Stand Mount

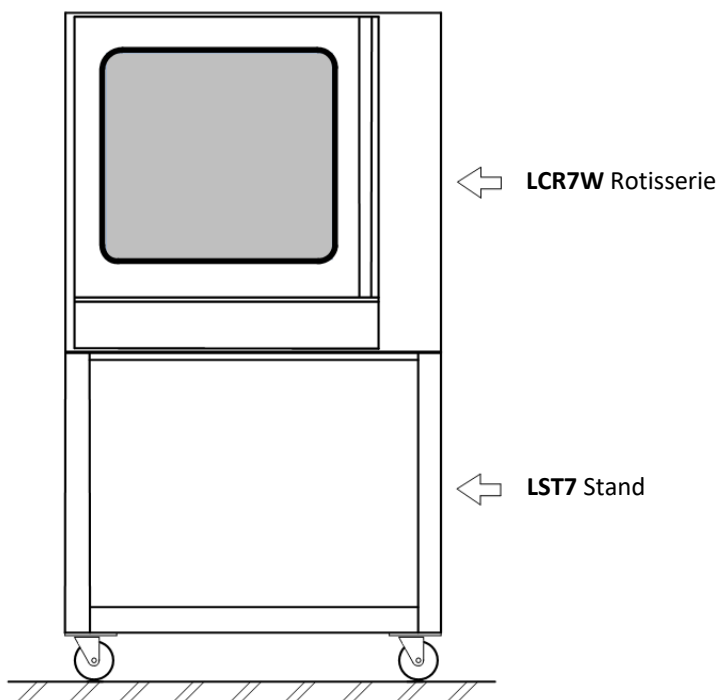

CONDITIONS of INSTALLATION

LBC Bakery Equipment shall, for a fee contingent on site location and provided that the conditions of installation are met, provide a factory-authorized service agency to install the LBC Rotisserie. The job site must be ready for the installation before LBC Bakery Equipment or its authorized agent arrives. If the installation site is not properly prepared or if there are construction delays, the customer shall be responsible for all expenses incurred during this delay. All expenses resulting from job delay or extension, for reasons beyond the control of LBC Bakery Equipment, shall be the responsibility of the customer. Installation shall be conducted during normal business hours. This installation is for a single trip. **Start-up and training are not included.**

IN ALL CASES, THE ELECTRICAL, WATER AND DRAIN CONNECTIONS AND VENTILATION MUST MEET ALL FEDERAL, STATE AND LOCAL CODES OR ORDINANCES.

It is the **responsibility of the owner/operator** to do the following:

- A. Secure all required permits and meet all local code requirements.
- B. Ensure the installation site is cleared and ready for installation before the authorized installer arrives on site. The site shall be smooth and level.
- C. Provide electrical utilities within five (5) feet of the installation location per the specifications provided by LBC Bakery Equipment
- D. Provide licensed trades person to make the final electrical and water connections.
- E. Provide adequate ventilation, including vented hoods and associated roof penetrations.
- F. Remove all packing materials, crates, etc. resulting from the installation.
- G. Provide any sheet metal work required by local codes or otherwise to bridge gaps between appliance and adjacent walls or other building structures.

RECEIVING and UNPACKING



WARNING

THE ROTISSERIE WEIGHS UP TO 600 LBS. FOR SAFE HANDLING, INSTALLER SHOULD OBTAIN HELP AS NEEDED OR EMPLOY APPROPRIATE MATERIAL-HANDLING EQUIPMENT (SUCH AS A FORKLIFT, DOLLY OR PALLET JACK) TO REMOVE THE UNIT FROM ITS PACKING MATERIALS AND TO MOVE IT TO THE PLACE OF INSTALLATION.



CAUTION

SHIPPING STRAPS ARE UNDER TENSION AND CAN SNAP BACK WHEN CUT.



Receiving

Upon receiving the appliance, immediately check for damage (both visible and concealed) and loss. **Visible damage must be noted on the freight bill at the time of delivery and signed by the carrier's agent.** Concealed damage or loss means damage or loss which does not become apparent until the merchandise has been unpacked. **If concealed damage or loss is discovered upon unpacking, make a written request for inspection by the carrier's agent within 15 days of delivery.** All packing material should be kept for the inspection. **DO NOT return damaged merchandise to LBC Bakery Equipment; you must file your claim with carrier.**









Location

Prior to unpacking, move the appliance as near to its intended location as practical. Existing packaging will help protect the oven from physical damage normally associated with moving it through hallways and doorways.

Unpacking

The appliance will arrive inside a carton or wood crate affixed to a pallet. Remove the outside packaging and strapping bands before lifting the unit from the pallet and placing in its intended location.

INSTALLATION (Part 1 of 5)

	WARNING	INSTALLATION OF THIS APPLIANCE MUST BE DONE BY PERSONNEL QUALIFIED TO WORK WITH ELECTRICITY. IMPROPER INSTALLATION CAN CAUSE INJURY TO PERSONNEL AND/OR DAMAGE TO EQUIPMENT.	
	CAUTION	ALL ELECTRICAL, MECHANICAL, GAS, VENTILATION AND EXHAUST CONNECTIONS MUST MEET ALL FEDERAL, STATE AND LOCAL CODES OR ORDINANCES.	
	CAUTION	THIS APPLIANCE WEIGHS UP TO 600 LBS. FOR SAFE HANDLING, INSTALLER SHOULD OBTAIN HELP AS NEEDED OR EMPLOY APPROPRIATE MATERIAL-HANDLING EQUIPMENT (SUCH AS A FORKLIFT, DOLLY OR PALLET JACK) TO REMOVE THE UNIT FROM ITS PACKING MATERIALS AND TO MOVE IT TO THE PLACE OF INSTALLATION.	
	CAUTION	ANY STAND, COUNTER OR OTHER DEVICE ON WHICH THIS APPLIANCE WILL BE LOCATED MUST BE DESIGNED TO SUPPORT ITS WEIGHT	
	NOTICE	During the first few hours of operation, you may notice a small amount of smoke and/or a faint odor coming from the appliance. This is normal in a new equipment and will disappear after a few hours of use.	

Clearances

Minimum clearance from combustibile construction: 0" from sides, 1" from back (single-door ovens only) or 6" from back (double-door ovens) and 6" from top. This appliance may be installed on combustibile surfaces. The installation location must allow adequate clearances for servicing and for proper operation of loading door(s).

Stand

If the oven is supplied with a stand, check the level of the top surfaces. If the stand is not level, add shims (washers are provided with the oven). Secure the oven to the stand with stainless steel hardware provided (16 each of the following: 10mm-1.2 x 20mm hex bolts, 10mm lock washers and 10mm plain washers.)

Drip Plates

Unpack and install the drip plates. No mounting hardware is required. The plates rest on the support pins located on each side wall.

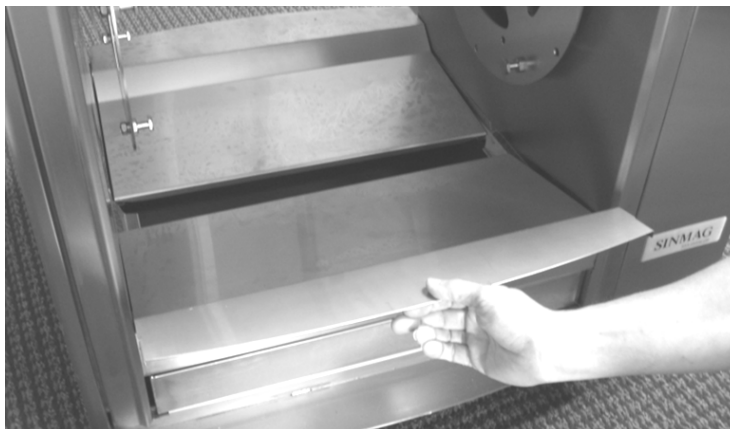

INSTALLATION (Part 2 of 5)

Interim Inspection

Verify/Perform the following:

1. Ensure loading door(s) open/close freely past 90° without obstruction.
2. Remove all packing materials from inside oven.
3. Remove carousel wheel shipping ties at carousel support hub (left wall) and drive arm (right wall).
4. Remove clear protective plastic covering from data plate and 15A fuse “Caution” plate.

Water Drain Connection

Locate the 1” hose barb fittings on the valve underneath the oven. (NOTE: There are two fittings; the water fitting is on the right as you face the backside of the oven.) Connect a 1” diameter PVC hose to the water fitting and secure with the band clamp provided. Route the hose to an air-gap floor drain.

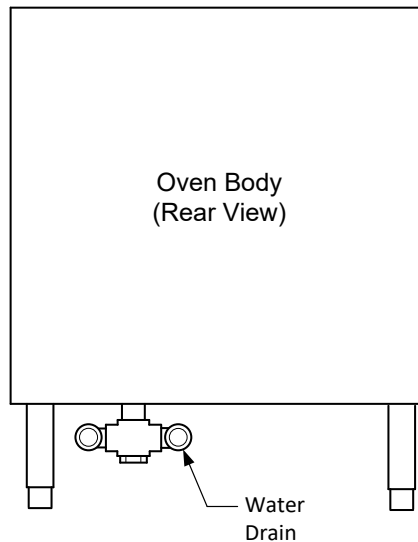

Grease Drain Connection

Locate the 1” hose barb fittings on the valve underneath the oven. (NOTE: There are two fittings; the grease drain fitting is on the left as you face the backside of the oven.) Connect a 1” diameter PVC hose to the grease fitting and secure with the band clamp provided. Route the hose to a grease receptacle.

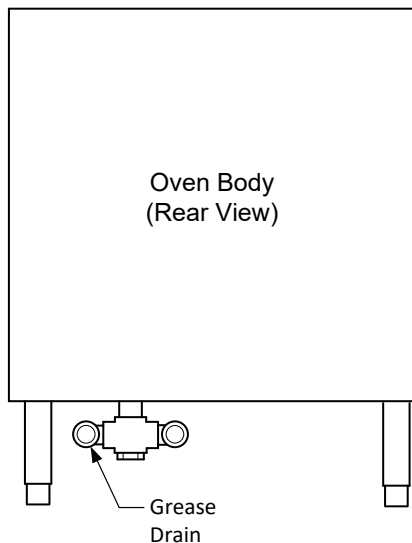

INSTALLATION (Part 3 of 5)

Soap Supply Connection

Connect the soap bottle to the soap inlet. All parts necessary to complete this step are included with the oven. Locate the tube connector (1/2" NPTM x 1/4" hose barb) and connect it to the oven soap inlet. Secure the tube with a band clamp. Attach the other end of the tube to the soap bottle cap and secure it with a band clamp.

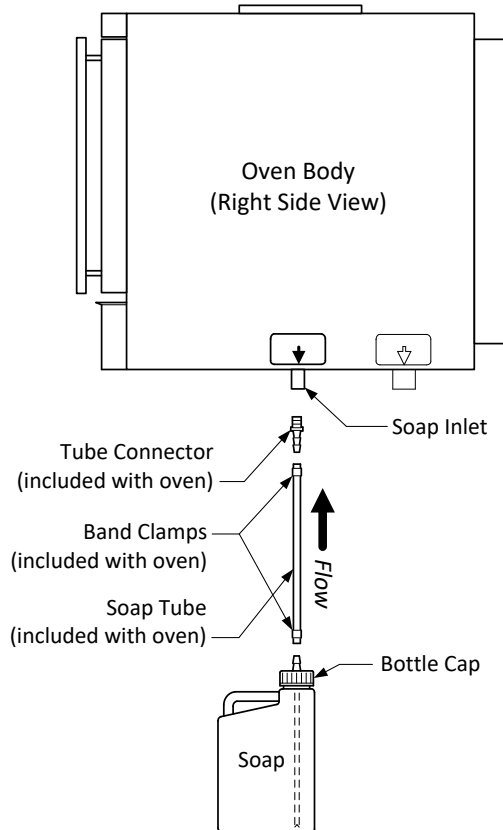

NOTE: For low-soap alert to function properly, the hose must be installed with no dips or flat lengths. It is strongly recommended to locate the soap bottle directly under the oven and route the hose as vertically as possible.

Water Supply Connection

Refer to water requirements (volume, pressure, temp, pipe size) outlined in Specifications section. Connect the water supply to the 3/4" hose fitting located at the water inlet. A flexible water line is recommended if the oven is installed with a stand. If using a flexible water line, provide sufficient length to allow the oven to be moved for cleaning without applying tension to the connections.

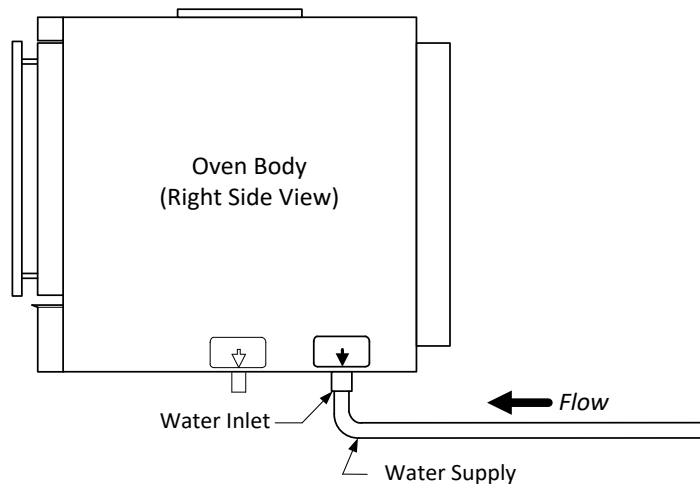

INSTALLATION (Part 4 of 5)

Electrical Connection

Power can be connected from the top or bottom of the oven at the existing knockout holes in the ceiling or the floor of the control compartment. A flexible conduit or cord is recommended if the oven is installed with a stand. If using flexible conduit, provide sufficient length to allow the oven to be moved for cleaning without applying tension to the connections.

Functional Check (also refer to Controller Operation section)

Turn the oven on, rotate the valve handle to Cook and verify:

1. Oven automatically pre-heats to the temp programmed in an open recipe.
2. Carousel wheel rotates.
3. Interior lights are off.
4. Interior fans and the control-area cooling fans are on.

While the oven is preheating, open the loading door and verify:

5. The word "door" flashes in the timer display. (NOTE: For ovens with two doors, check each door independently).
6. Heat is off (elements are de-energized).
7. Carousel wheel stops rotation.
8. Interior light(s) are on.
9. Press the yellow pushbutton on the jamb and ensure the carousel wheel rotates. Release pushbutton and ensure the carousel wheel stops.

While the oven is preheating, close the loading door, press the Timer Start/Stop button and verify:

10. Interior lights turn on when the Timer begins counting.

Rotate the valve handle to Wash and verify:

11. Interior lights are off.
12. Pump energizes and soap is drawn from the soap bottle.
13. "Saun - dEtErgEnt" message does not appear and buzzer is silent when pump runs with soap hose immersed in liquid.
14. "Saun - dEtErgEnt" message appears and buzzer sounds when pump runs and soap hose is not immersed in liquid. Ensure hose is completely empty of liquid to perform this step.
15. Oven cools or heats to 150°F.
16. Water valve opens, spraying the soap/water mix into oven through spray arm.
17. Spray arm spins freely when the water valve opens.
18. At the end of the wash cycle, the oven automatically shuts off.

Chain Restraint Kit (Optional)

Units on stands must be secured to a building structure with a chain restraint. Affix one end of the restraint to the side panel of oven (the non-control side is recommended) at any existing panel mount screw. An additional hole must be drilled next to the existing mount screw to affix the 2-hole plate located on either end of the restraint. A drill bit and mounting hardware are provided in the chain restraint kit. Attach the loose end of the restraint to a secure structure and affix the warning label provided ("WARNING – ATTENCION: RISK OF ELECTRIC SHOCK ...") to the control-side panel.

Set Temperature Scale

Simultaneously press-and-hold both set point arrows for 3 seconds to change the temp scale from °F to °C and back. Once set, the selected scale will remain active unless re-set otherwise.

Controller Calibration

Insert a thermocouple inside the cook chamber at the center of any oblong hole in the ceiling fan cover. Route the probe wire out of the loading door opening and adjust the oven set point to 350°F. Allow the oven to reach set point

INSTALLATION (Part 5 of 5)

and stabilize for at least 90 minutes. If the thermocouple reading and the controller actual temp differ by more than a couple degrees, the control must be calibrated. To begin, make a note of the temp difference between the thermocouple and controller actual temp, then turn control power button off and simultaneously press-and-hold the set temp up/down arrows for 3 seconds until a value appears in set point display. Use set point up or down arrow to add or subtract difference in temp. (EXAMPLE: If thermocouple is 10° higher than actual temp, add 10. If thermocouple is 10° lower than actual temp, subtract 10.) Turn control button on and re-check thermocouple against controller actual temp. Repeat this procedure until both temps match.

Final Inspection

Verify the following:

1. All screws are tight
2. All electrical connections are tight
3. All plumbing connections are tight and do not leak
4. Fingerprints, dirt and sticker residue have been cleaned from oven

CONTROLLER OPERATION

PROGRAM SELECT
SÉLECTION de PROGRAMME

Silence Alarm Button

Quick-Select Recipe Buttons

Recipe Save Button
After creating a recipe, press this button twice to save it

SET
RÉGLAGE

Actual Temp Display

Set Point Display

Time Display

Cook Event Buttons
Use these when creating a recipe; up to 3 events may be programmed
(NOTE: To ignore Sear and/or Roast events, enter a time of 0:00 for that event)

Back+3 Button
Press to go back one event and add 3 minutes. Each additional press adds another 3 minutes.

Change Temperature Scale
Simultaneously press-and-hold up and down arrows for 3 seconds to change scale from °F to °C and back

OPERATE
OPÉRER

Wash Button
1X = Normal Wash;
2X = Heavy Wash.
Press to change from 1X to 2X and back again.

Timer Start/Stop/Reset Button
Press to start/stop Timer; press-and-hold for 3 seconds to reset Timer

PARTS LIST (Part 1 of 5)



WARNING

BOTH HIGH AND LOW VOLTAGES ARE PRESENT INSIDE OF THIS APPLIANCE WHEN THE UNIT IS PLUGGED/WIRED INTO A LIVE RECEPTACLE. BEFORE REPLACING ANY PARTS, DISCONNECT THE UNIT FROM THE ELECTRIC POWER SUPPLY.



CAUTION

USE OF ANY REPLACEMENT PARTS OTHER THAN THOSE SUPPLIED BY LBC OR THEIR AUTHORIZED DISTRIBUTORS CAN CAUSE BODILY INJURY TO THE OPERATOR AND/OR DAMAGE TO THE APPLIANCE AND WILL VOID ALL WARRANTIES.



NOTICE

Service on this or any other LBC appliance must be performed by qualified personnel. For an approved service representative in your area, visit our website at www.lbcbakery.com or call our factory toll free at 1-888-722-5686.

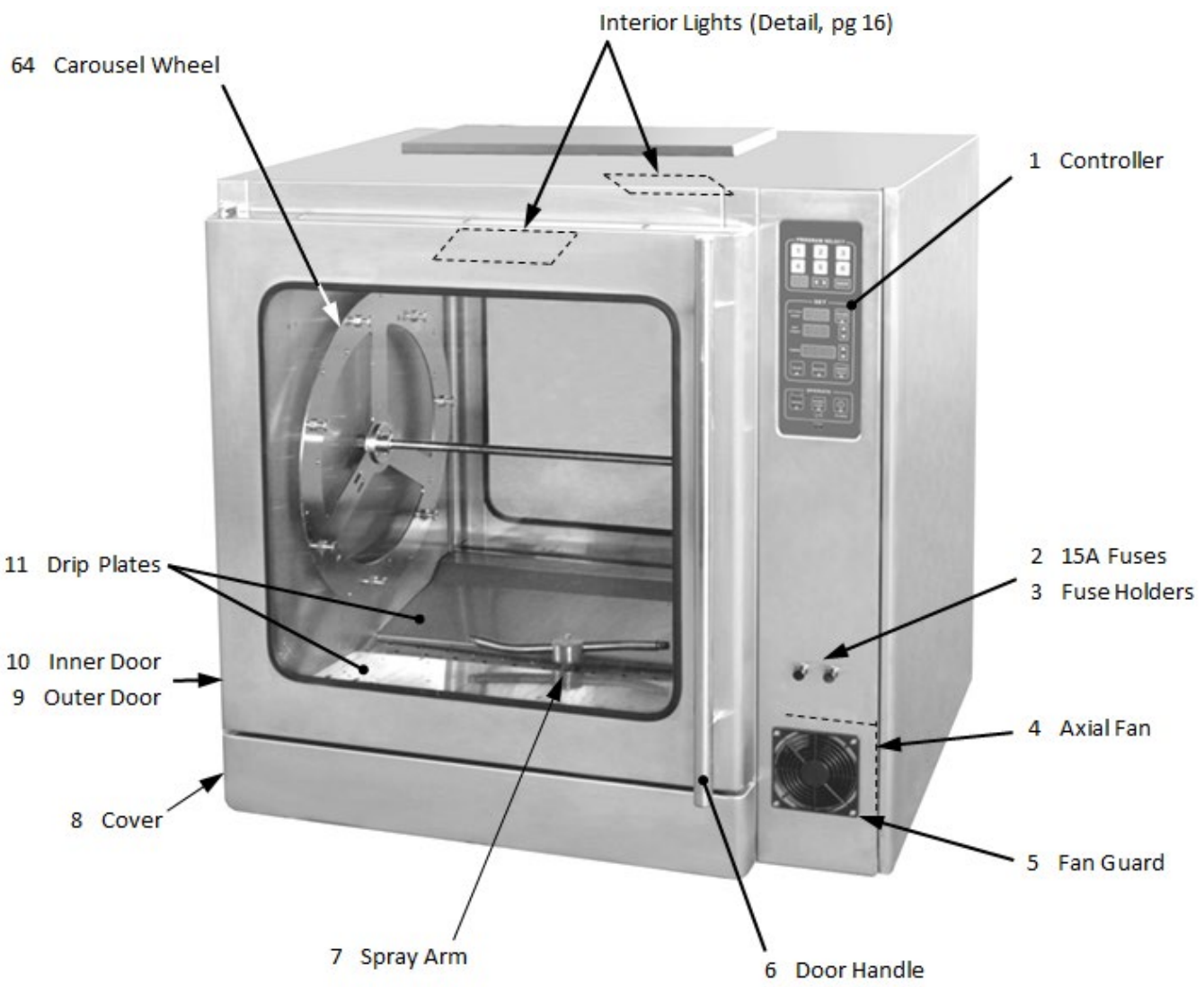

PARTS LIST (Part 2 of 5)

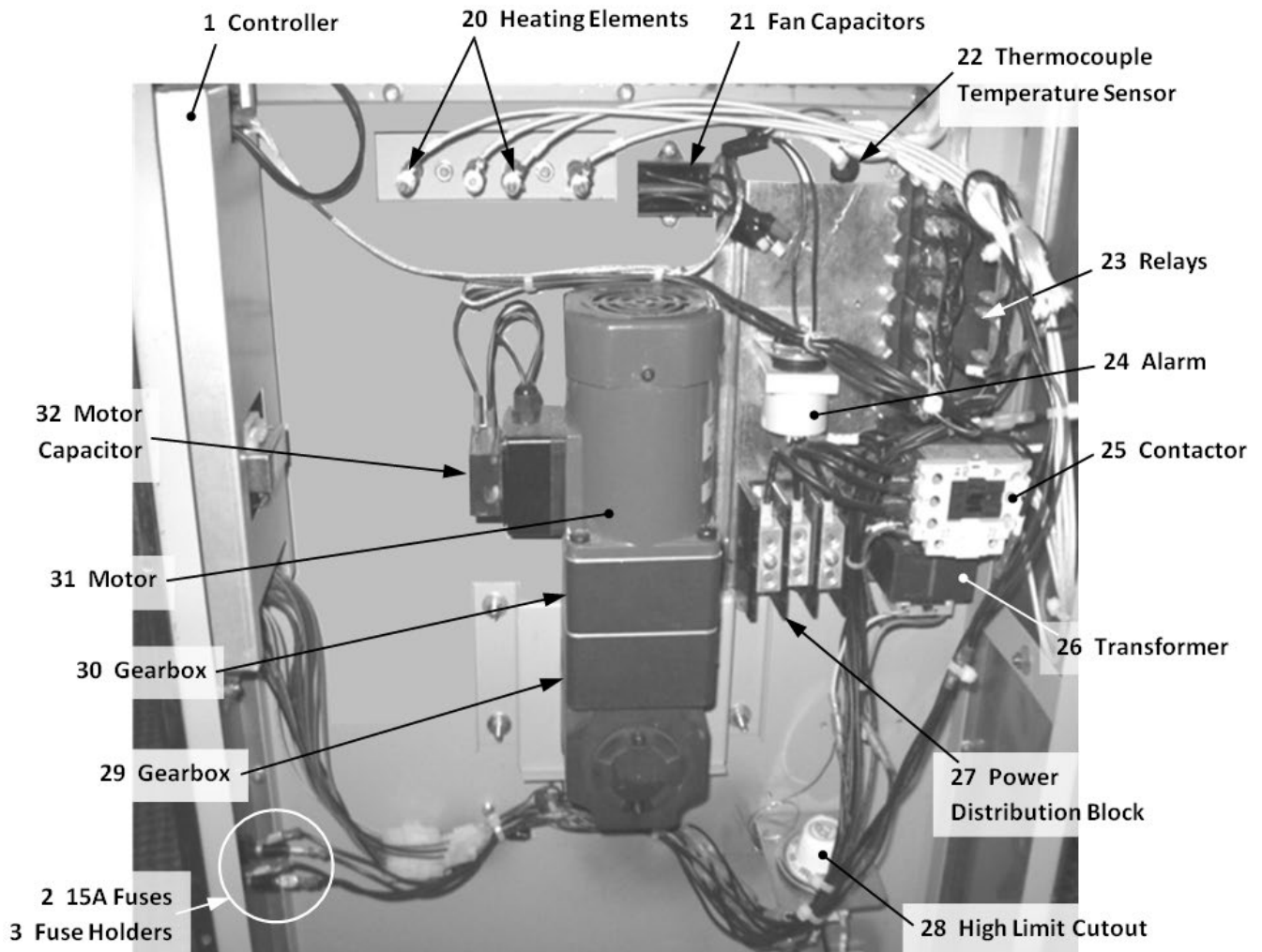

Control Compartment (Side Panel Removed)



Thermal Snap Disc

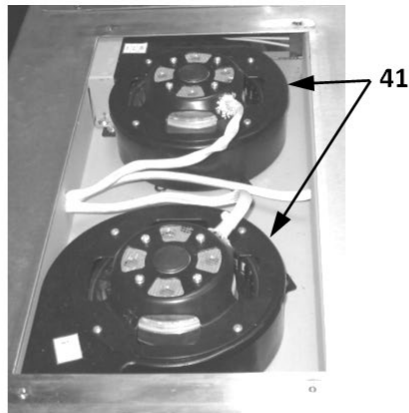

Ceiling Fans

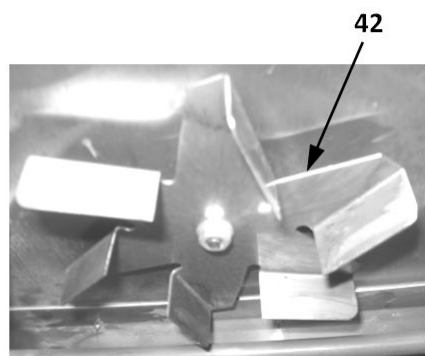

Ceiling Fan Blade

PARTS LIST (Part 3 of 5)

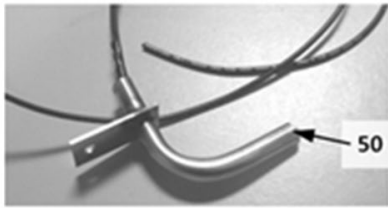

Door Switch

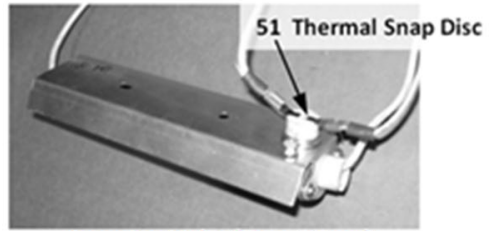

Interior Light (Rear View)

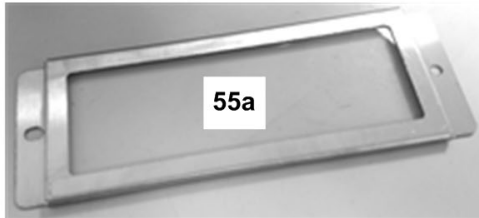

Interior Light Cover

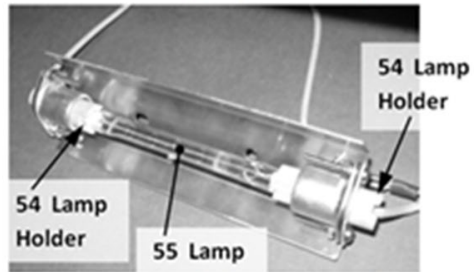

Interior Light (Front View)



Pressure Switch

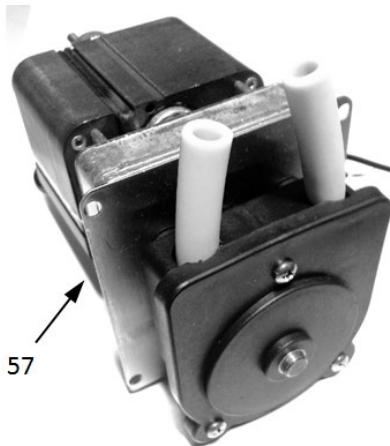

Soap Pump



Water Valve

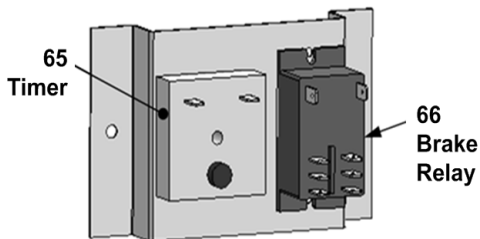

Timer & Brake Relay



Water / Grease Valve Switches

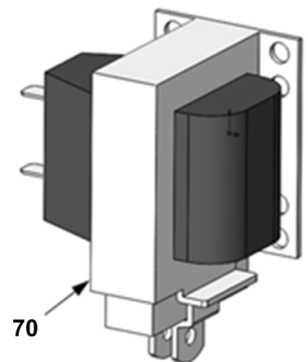

Brake Solenoid

PARTS LIST (Part 4 of 5)

Item No.	Part Description	Quantity	Part No.	Comments
1	Controller	1	40102-75	WDRs without valve switches
			40102-75-F	WDRs with valve switches
2	15A Fuse	2	30900-01	
3	Fuse Holder	2	30901-02	
4	Axial Fan	2	30200-46	
5	Fan Guard	2	50201-11	
6	Handle, Loading Door	1 or 2	180-781-2	Tubular handle
			50800-96	Latching handle
7	Spray Arm	1	180-794-1	
8	Cover, Reservoir	1 or 2	180-783-1	
9	Loading Door, Outer	1 or 2	180-744-4	WDRs with "e" profile door gasket
			180-744-5	WDRs with flat sheet door gaskets
10	Loading Door, Inner	1 or 2	180-743-1	WDRs with "e" profile door gasket
			180-837-1	WDRs with flat sheet door gaskets
11	Drip Plate	2	- - -	Call factory
20	Element, Heating (2kW)	0 or 1	11090-40	Single phase only
	Element, Heating (3kW)	2 or 3	11090-39	
21	Capacitor, Fan (2.2µF)	2	40704-11	
22	Thermocouple Temperature Sensor	1	41100-42	
23	Relay	4	30701-05	
24	Alarm	1	30802-07-1	
25	Contactator	1	30700-17	
26	Transformer	1	31400-26	
27	Power Distribution Block	1	30500-07	
28	High Limit Cutout	1	30401-33	
29	Gearbox (90 Degrees, 1:90 Ratio)	1	30200-50	
30	Gearbox (1:10 Ratio)	1	30200-49	
31	Motor	1	30200-51	
32	Capacitor, Motor (4.0µF)	1	40704-10	
40	Thermal Snap Disc (Relay Protection)	1	30301-05	
41	Fan, Ceiling	2	71500-32	
42	Fan Blade, Ceiling	2	180-205-1	
50	Door Switch Assembly	1 or 2	180-767-2	One switch per loading door
51	Thermal Snap Disc (Lights)	1 or 2	30301-06	
54	Lamp Holder	2 or 4	31602-21	
55	Lamp, 200W	1 or 2	31603-88	
55a	Interior Light Cover	1 or 2	180-774-2	
56	Switch, Pressure	1	30308-07-B	Low soap detection
57	Pump, Peristaltic	1	70403-07	
58	Valve, Solenoid - Water	1	70403-08	

PARTS LIST (Part 5 of 5)

64	Carousel Assembly, Stainless Steel	1	180-816	See item 94 for non-stick carousel assembly
65	Timer	1	30701-07	
66	Relay, Brake	1	30701-05-240	
67	Water / Grease Valve Switch	2	30301-15	Roller switch
			30308-20	Magnetic switch
70	Solenoid, Brake	1	70403-04-1-240	

Optional Parts and Accessories

Item No.	Part Description	Quantity	Part No.	Comments
90	Stand with Casters	1	LST7	
91	Mobile Skewer Rack	1	MSR7	
92	Caster (Swivel with Brake)	4	72901-33	
93	6" Adjustable Leg	4	72901-34	
94	Carousel Assembly, Non-Stick Coating	1	180-816-C	
95	Angle Spit	7	LCR7-SV	Stainless steel
			LCR7-SV-C	Non-stick coating
96	Fork Spit	7	LCR5-SF	Stainless steel
			LCR7-SF-C	Non-stick coating
97	Basket	7	LCR7-SB	Stainless steel
			LCR7-SB-C	Non-stick coating
98	Chain Restraint Kit	1	72609-51	
99	Cap, Soap Bottle	1	72103-06	
100	Soap (Ecolab CIP Oven Cleaner)	Varies	72103-05	Carton with 2 ea 2.5 gal [9.5 liter] bottles
110	Seal, Vertical – Door Opening	2	180-550	Installed at sides of oven door opening
111	Seal, Horizontal – Door Opening	1	180-550-2	Installed at top of oven door opening
112	Seal, Horizontal – Inner Loading Door	1	180-555-3	Installed on inner loading door

NOTES



LIMITED WARRANTY

LBC Bakery Equipment ("LBC Equipment") has been skillfully manufactured, carefully inspected and packaged to meet rigid standards of excellence. LBC Bakery Equipment, Inc. (LBC) warrants products produced and sold by LBC and its duly authorized agents against defects in materials and workmanship within the following limitations:

What is Provided:

- Limited replacement parts as specified below, including standard ground shipping from LBC or service parts center when required.
- Limited labor for repair as specified below, including authorized service agent's transportation, portal to portal, up to one hundred (100) miles round trip and two (2) hours travel time.
- LBC, or an authorized service representative, will repair or replace, at LBC's sole discretion, any LBC equipment, including but not limited to the listed exclusions.

Coverage Period:

Extending from the date of shipment from LBC or its duly authorized dealer/distributor for the specified period:

- LRO and LMO Model Rack Ovens, LRP Model Rack Proofers, LRPR Model Retarder Proofers, LCR Model Rotisseries and LHC Model Holding Cabinets for a period of one (1) year limited parts and labor.
- Replacement parts shall be warranted for a period of ninety (90) days after installation by an authorized LBC service agent.

Conditions:

- Covered equipment must have been properly installed according to the requirements of the installation manual and all applicable local codes.
- The equipment shall not have been abused, misused or neglected or used for purposes other than intended by LBC.
- Water connected to the appliance shall have been in compliance with the following requirements:
 - Cold Water: 30 - 80 PSI
 - pH: 7 - 7.5
 - Conductivity: < 1/500,000 Ω per inch
 - Total Dissolved Solids: < 100 ppm
 - Hardness: 6.3 - 8.8 grains per gallon
 - Maximum Salinity and Ion content:
 - Chlorides: < 30 ppm
 - Sulfates: < 40 ppm
 - Iron: < 0.1 ppm
 - Copper: < 0.05 ppm
 - Manganese: < 0.05 ppm
- It is the responsibility of the purchaser to install and maintain the water supply to the appliance. Failure to provide satisfactory water quality in accordance with the operating manual requirements can cause damage to internal components and will VOID the warranty.
- All repair work is to be performed by an LBC authorized service agent.
- Equipment must be at the installation location of the original purchaser/user and shall not have been resold or reclaimed by another party.

Conditions (Continued):

- LBC equipment is for commercial use only. If sold as a component of another (OEM) manufacturer's equipment, or if used as a consumer product, such equipment is sold AS IS and without any warranty.
- Conditions of sale of the equipment shall have been met in full.
- The request for repair shall be made within the limited period of the warranty.
Failure to meet the above conditions will void this warranty.

Exclusions:

This warranty does not cover the following:

- Routine general maintenance, or periodic adjustment.
- Thermostat calibration after the first 30 days of use.
- Glass, Lamps, Gaskets, Oven Racks and other consumable parts.
- Air and gas burner adjustments.
- Fuse replacement.
- Cleaning and adjusting burners and pilot burners.
- Rack oven shutter adjustments.
- Repairs adjustments and corrections in the refrigeration portion of retarder/proofers resulting from the improper installation.
- Retightening of screws and fasteners.
- Failures caused by erratic or inadequate electrical, water, ventilation or gas service.
- Unauthorized repairs.
- Premature rusting, corrosion, or mineral build up caused by incoming water.
- Attached water treatment systems.
- Expedited freight on replacement parts other than standard ground shipments.
- Ordinary wear and tear.
- Use of the equipment for purposes other than those intended including non-commercial use such as residential or domestic.
- Appliances installed outside the contiguous U.S., including Alaska and Hawaii, and Canada.
- Incidental costs, charges, loss of business and damages as incurred by the user or others as a result of the use or failure of the equipment.
- Work and workmanship of the authorized service agent or others in the repair of the equipment.
- Other failures that are beyond the reasonable scope of this warranty.
- Damage caused during shipment is to be reported to the carrier, is not covered under this warranty, and is the sole responsibility of the purchaser/user.
- Natural disaster.

This warranty is exclusive and in lieu of all other warranties, expressed or implied, including expressed or implied warranties of merchantability or fitness for a particular purpose, each of which is hereby expressly disclaimed. The remedies described herein are exclusive and in no event shall LBC be liable for special, consequential or incidental damages for the breach or delay in the performance of this warranty