

















**Service Manual for the Lang Models:  
ECCO-T, ECCO-AP, ECCO-SII, ECCO-C, ECCO-PP, ECCO-PT,**

# TABLE OF CONTENTS

<b><u>CHAPTER</u></b>	<b><u>PAGE</u></b>
1. TABLE OF CONTENTS .....	1
2. READ FIRST .....	2
3. EQUIPMENT DESCRIPTION .....	4
4. INSTALLATION.....	6
5. START-UP .....	7
6. CONTROL PANEL LAYOUT.....	8
7. PROGRAMMING TERMS.....	14
8. PROGRAMMING .....	15
9. GENERAL OPERATION.....	25
10. TYPICAL OPERATION .....	27
11. SEQUENCE OF OPERATION .....	30
12. TROUBLESHOOTING .....	34
13. TECHNICAL DATA .....	46
14. WIRING DIAGRAMS.....	52
15. PARTS LIST.....	64

<b><u>CAUTION</u></b>	EACH UNIT WEIGHS 430 LBS. FOR SAFE HANDLING, INSTALLER SHOULD OBTAIN HELP AS NEEDED, OR EMPLOY APPROPRIATE MATERIALS HANDLING EQUIPMENT (SUCH AS A FORKLIFT, DOLLY, OR PALLET JACK) TO REMOVE THE UNIT FROM THE SKID AND MOVE IT TO THE PLACE OF INSTALLATION.	
<b><u>CAUTION</u></b>	ANY STAND, COUNTER OR OTHER DEVICE ON WHICH OVEN WILL BE LOCATED MUST BE DESIGNED TO SUPPORT THE WEIGHT OF THE OVEN.	
<b><u>CAUTION</u></b>	SHIPPING STRAPS ARE UNDER TENSION AND CAN SNAP BACK WHEN CUT.	
<b><u>DANGER</u></b>	<b>THIS APPLIANCE MUST BE GROUNDED AT THE TERMINAL PROVIDED. FAILURE TO GROUND THE APPLIANCE COULD RESULT IN ELECTROCUTION AND DEATH.</b>	
<b><u>WARNING</u></b>	<b>INSTALLATION OF THE UNIT MUST BE DONE BY PERSONNEL QUALIFIED TO WORK WITH ELECTRICITY AND PLUMBING. IMPROPER INSTALLATION CAN CAUSE INJURY TO PERSONNEL AND/OR DAMAGE TO EQUIPMENT. UNIT MUST BE INSTALLED IN ACCORDANCE WITH ALL APPLICABLE CODES.</b>	
<b><u>NOTICE</u></b>	The data plate is located above control panel behind wire mesh screen. The oven voltage, wattage, serial number, wire size, and clearance specifications are on the data plate. This information should be carefully read and understood before proceeding with the installation.	
<b><u>NOTICE</u></b>	The installation of any components such as a vent hood, grease extractors, fire extinguisher systems, must conform to their applicable National, State and locally recognized installation standards.	
<b><u>NOTICE</u></b>	During the first few hours of operation you may notice a small amount of smoke coming off the oven, and a faint odor from the smoke. This is normal for a new oven and will disappear after the first few hours of use.	
<b><u>CAUTION</u></b>	ALWAYS KEEP THE AREA NEAR THE APPLIANCE FREE FROM COMBUSTIBLE MATERIALS.	
<b><u>CAUTION</u></b>	KEEP FLOOR IN FRONT OF EQUIPMENT CLEAN AND DRY. IF SPILLS OCCUR, CLEAN IMMEDIATELY, TO AVOID THE DANGER OF SLIPS OR FALLS.	
<b><u>WARNING</u></b>	<b>KEEP WATER AND SOLUTIONS OUT OF CONTROLS. NEVER SPRAY OR HOSE CONTROL CONSOLE, ELECTRICAL CONNECTIONS, ETC.</b>	
<b><u>CAUTION</u></b>	MOST CLEANERS ARE HARMFUL TO THE SKIN, EYES, MUCOUS MEMBRANES AND CLOTHING. PRECAUTIONS SHOULD BE TAKEN TO WEAR RUBBER GLOVES, GOGGLES OR FACE SHIELD AND PROTECTIVE CLOTHING. CAREFULLY READ THE WARNING AND FOLLOW THE DIRECTIONS ON THE LABEL OF THE CLEANER TO BE USED.	
<b><u>NOTICE</u></b>	Never leave a chlorine sanitizer in contact with stainless steel surfaces longer than 10 minutes. Longer contact can cause corrosion.	
<b><u>NOTICE</u></b>	Service on this, or any other, LANG appliance must be performed by qualified personnel only. Consult your authorized service station directory or call the factory at 1-800-224-LANG (5264), or WWW.LANGWORLD.COM for the service station nearest you.	

<p><b><u>WARNING</u></b></p>	<p><b>BOTH HIGH AND LOW VOLTAGES ARE PRESENT INSIDE THIS APPLIANCE WHEN THE UNIT IS PLUGGED/WIRED INTO A LIVE RECEPTACLE. BEFORE REPLACING ANY PARTS, DISCONNECT THE UNIT FROM THE ELECTRIC POWER SUPPLY.</b></p>
<p><b><u>CAUTION</u></b></p>	<p><b>USE OF ANY REPLACEMENT PARTS OTHER THAN THOSE SUPPLIED BY LANG OR THEIR AUTHORIZED DISTRIBUTORS CAN CAUSE BODILY INJURY TO THE OPERATOR AND DAMAGE TO THE EQUIPMENT AND WILL VOID ALL WARRANTIES.</b></p>



## Lang Model: ECCO Electric Full Size Convection Oven

### EXTERIOR

- The oven exterior dimensions are 40" (100 cm) Wide, 27" (67.5 cm) High, 38" (95 cm) Deep. The Top, Front, Back, and Sides are constructed of stainless steel with an aluminized bottom.
- The oven doors come standard with double pane windows.
- The door handle is constructed of Stainless Steel and Phonolic Tubing.
- The oven cavity is insulated with high temperature insulation for efficiency and reduced heat loss.

### INTERIOR

- The oven cavity dimensions are 29" (72.5 cm) Wide, 20" (50.84 cm) High, 21" (53.38 cm) Deep.
- The oven is designed for a maximum of five shelves and comes with five Chrome Plated Racks.
- The interior of the oven is constructed of porcelainized stainless steel.

### OPERATION

- The ECCO oven is a forced air convection oven with a adjustable vented oven cavity.
- A 1/3 HP fan motor drives the air.

### CONTROLS

- The ECCO is available either with the Lang Accu-Temp (ECCO-T), Accu-Plus (ECCO-AP), Selectronic (ECCO-SII), "Purple" Computer (ECCO-C), "Purple Plus" Computer (ECCO-PP), and the "Platinum" Computer (ECCO-PT):
- **ECCO-T**
  - Easy to use manual control knobs.
  - Pulse and two speed fan.
- **ECCO-AP**
  - Easy to use manual control knobs.
  - Pulse and two-speed fan.
  - Solid State temperature sensing and controls.
- **ECCO-SII**
  - Complete Computerized Controls.
  - Solid State temperature controls.
  - Digital Display

## EQUIPMENT DESCRIPTION CONT'D

- **ECCO-C**
  - Complete Computerized Controls with a Manual Override system.
  - Programmable up to 10 products with four “tiers” for each program.
  - Independent Shelf Timers for each Shelf.
  - Load Control through use of Cooking Curves.
  - Shelf Compensation Timing for uniform baking.
  - Single speed fan.
  
- **ECCO-PP**
  - The Purple Plus offer the same great one touch system of the Purple, coupled with the advanced baking capabilities of the new Platinum
  
- **ECCO-PT**
  - Icon-driven (touch) panel allows for easy operation, also includes a manual override system.
  - Day-Part Memory capabilities allow operators to “recall” the last daily selections automatically.
  - Programmable up to 99 products, advanced baking capabilities include: a 12:59:59 timer with ten “tiers”.
  - Independent Shelf Timer for each Shelf.
  - Load Control through use of Cooking Curves.
  - Shelf Compensation Timing for uniform baking.
  - Dual speed fan.

## **RECEIVING THE OVEN**

Upon receipt, check for freight damage, both visible and concealed. Visible damage should be noted on the freight bill at the time of delivery and signed by the carrier's agent. Concealed loss or damage means loss or damage, which does not become apparent until the merchandise has been unpacked.

If concealed loss or damage is discovered upon unpacking, make a written request for inspection by the carrier's agent within 15 days of delivery. All packing material should be kept for inspection.

Do not return damaged merchandise to Lang Manufacturing Company. File your claim with the carrier.

Prior to un-crating, move the oven as near its intended location as practical. The crating will help protect the unit from the physical damage normally associated with moving it through hallways and doorways.

## **LEG INSTALLATION**

Legs are available for both the single and double deck installations. Single deck installations require a 27-inch leg. Double deck installations require 6-inch legs or casters.

To install the 27-inch legs, place some cardboard on the floor and gently tip the oven onto its back. Fasten two legs to the oven's front corners using the four 5/16 inch bolts provided in the leg kit. Lift the oven onto its front legs and block the back up using one of the 27-inch legs set upside down in the center rear of the oven body. Install the last 27-inch leg onto the oven body on the control side rear. Gently lift the oven rear, remove the leg set to support the oven center and install it on the last rear corner.

To install the 6-inch legs or casters, attach the leg or caster to the leg supports supplied in the oven by following the instructions in the box, then attach the leg support to the oven.

The adjustable feet on the bottom of each leg may be screwed in or out as necessary to level the oven.

## **STACKING THE OVENS**

Remove all the plug buttons from the top of the lower oven.

Remove the stacking kit from the oven compartment of one oven and install the 1 1/4-inch plastic bushing into the top of the lower oven.

Tip the top oven backwards and install two 3/8-inch socket head bolts, found in the stacking kit, into the two front leg holes that match the holes in the top of the lower oven. Install the socket head bolts with the heads of the bolt pointing away from the oven.

Lift the top oven and gently set on top of the lower oven so that the heads of the socket head bolts nest into the holes in the top of the lower oven.

## **ELECTRICAL CONNECTION**

The electrical service entrance is provided by a 1 1/4-inch knockout in the bottom right front corner of each oven, or at the oven back directly behind the control compartment. Grounding lugs are provided at both the front and rear service entrances.

The 208/240-volt oven is a dual voltage oven and is shipped from the factory as 208 volt. The oven must be field converted to operate on a 240-volt power supply.

To convert the oven to 240 volt, remove the jumper wire located on a terminal strip located inside the lower portion to the control compartment. On newer oven a toggle switch is provided at the back of the unit for this purpose.

With 480-volt installations check to be sure that the motor rotates in a clockwise direction as viewed from the front of the oven.

To reverse the motor rotation, switch any two incoming power supply leads and recheck the rotation.

Supply wire size must be large enough to carry the amperage load for the number of ovens being installed.

Wire size information can be found on the oven DATA PLATE.

This oven can be installed on both single and three phase supplies and is shipped from the factory for three phase.

To phase the oven to match the power supply, follow the charts in the Technical Data portion of this manual or to the wiring diagram for proper wire size and grouping.

**ECCO-AP / ECCO-C / ECCO-PP / ECCO-PT / ECCO-SII / ECCO-T**  
Convection Oven Start-Up

1) Verify connections at plug and terminal block

2) Incoming Volt - Single Phase L1-L2 \_\_\_\_\_  
Three Phase L1-L2 \_\_\_\_\_ L2-L3 \_\_\_\_\_ L3-L1 \_\_\_\_\_

3) Amp draw L1 \_\_\_\_\_  
L2 \_\_\_\_\_  
L3 \_\_\_\_\_

4) Motor amp draw \_\_\_\_\_

5) Are programs correct? Yes  No

6) Verify actual temperature at 350 °F \_\_\_\_\_ °F.

Note:

Install thermocouple wire in center of oven cavity.

Let oven cycle off and on 3 times before recording temperature.

**Set Temperature for 350 °F**

Model # \_\_\_\_\_ Date \_\_\_\_\_ Serial # \_\_\_\_\_

Store # \_\_\_\_\_ Tech Name \_\_\_\_\_  
Contact \_\_\_\_\_ Company \_\_\_\_\_  
Store Phone # \_\_\_\_\_ Service Company Phone # \_\_\_\_\_

Address \_\_\_\_\_  
\_\_\_\_\_  
\_\_\_\_\_

# CONTROL PANEL ECCO-T

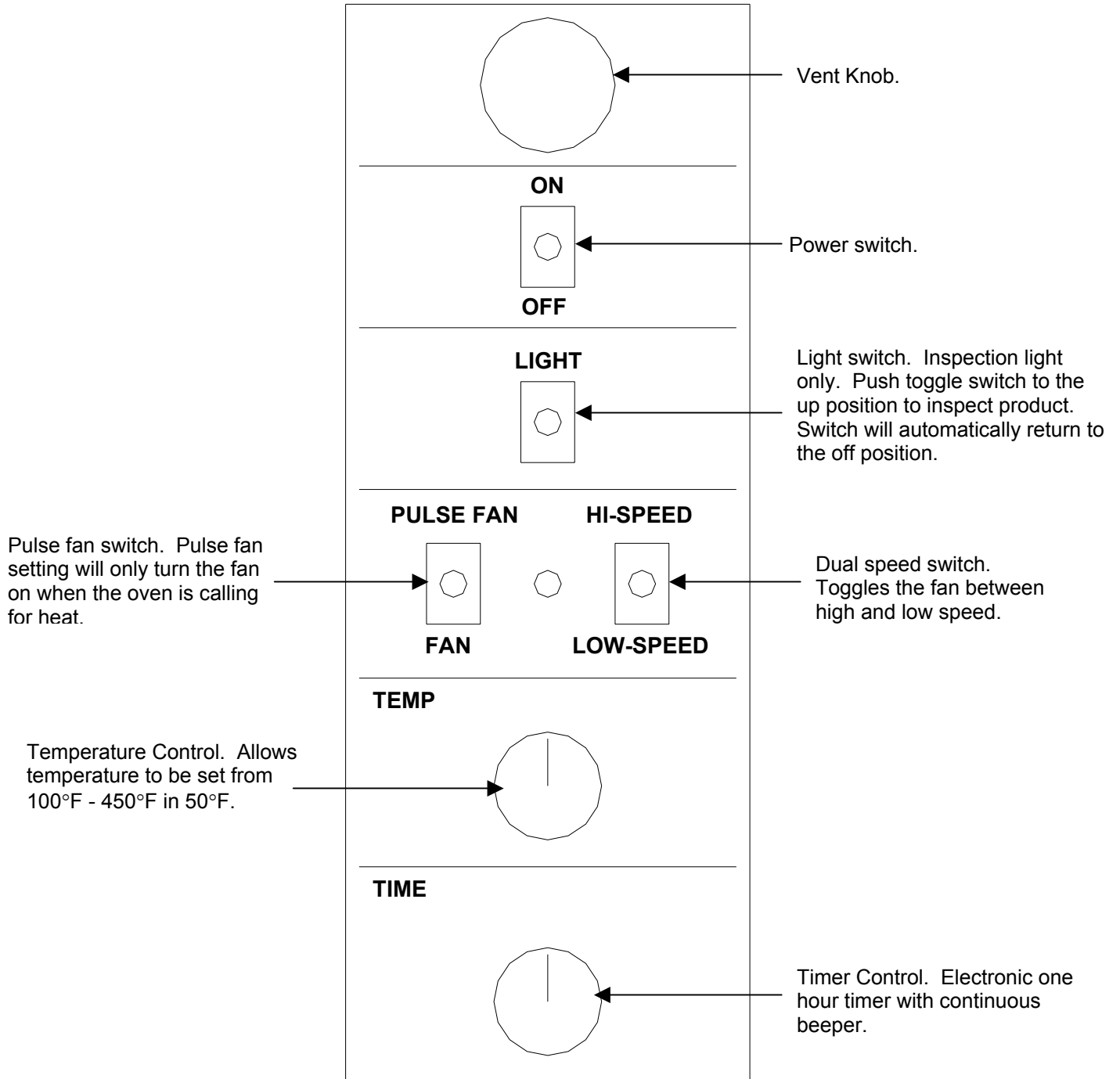

# CONTROL PANEL ECCO-AP

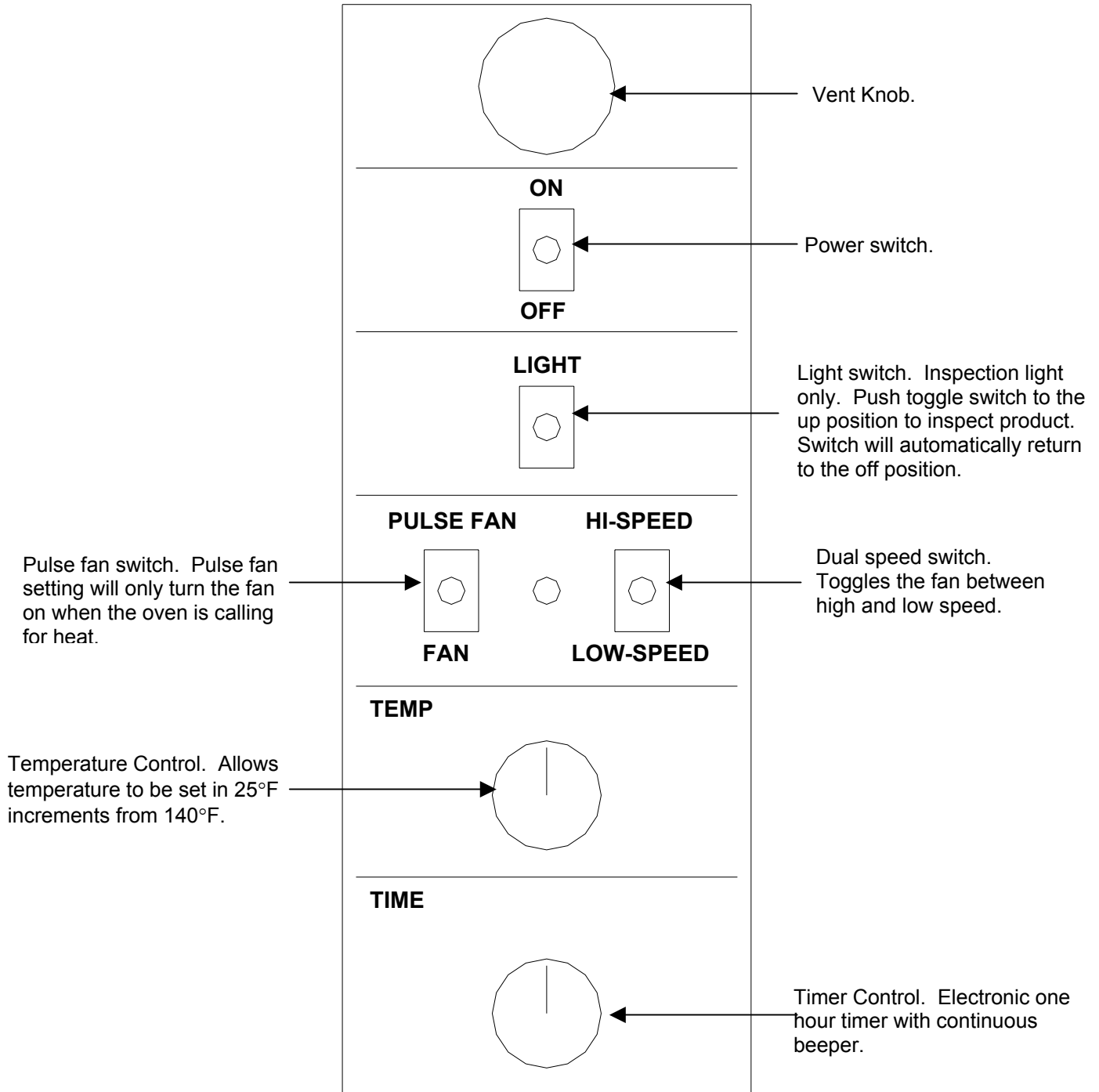

# CONTROL PANEL ECCO-SII

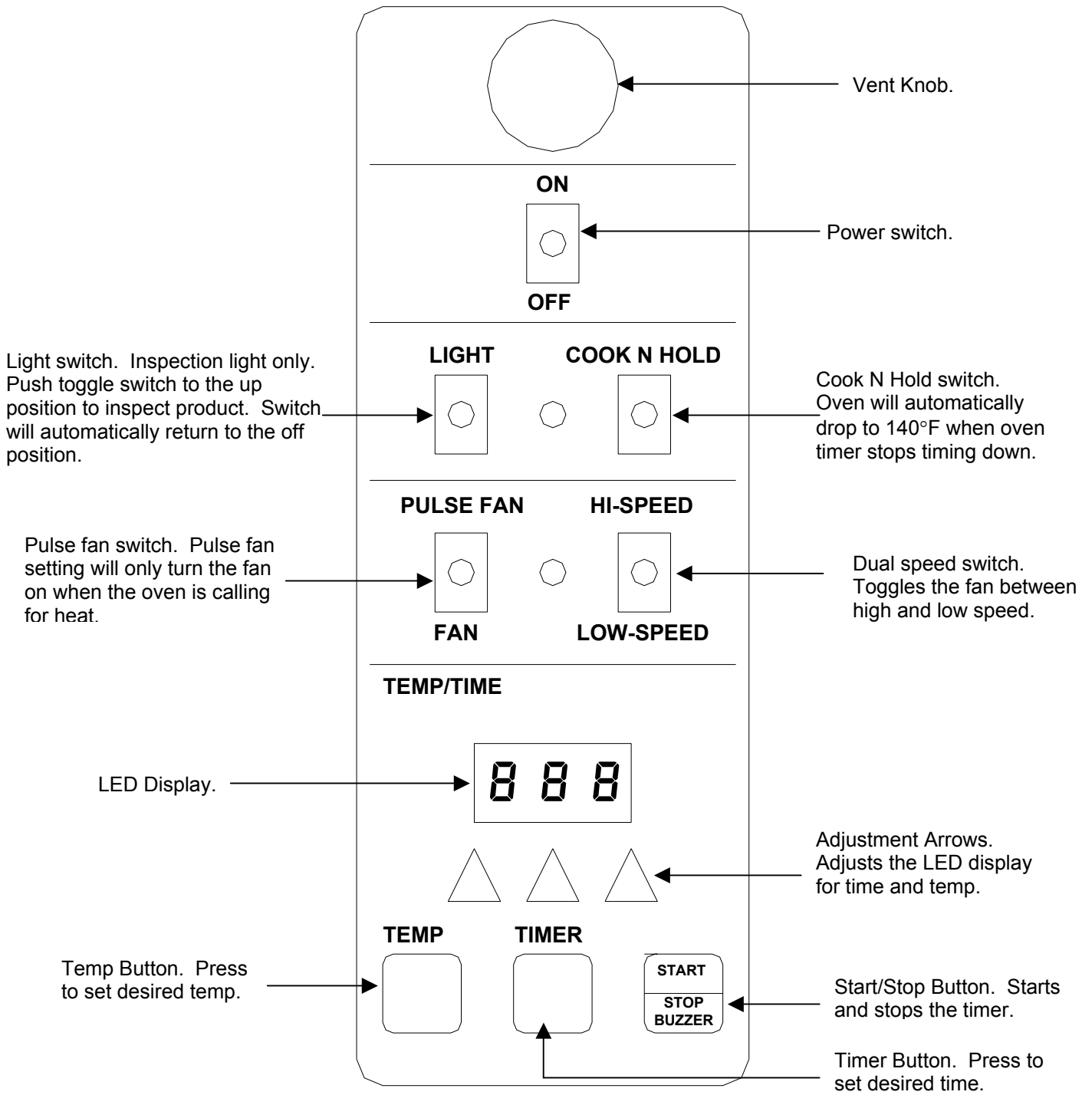

# CONTROL PANEL LAYOUT ECCO-C

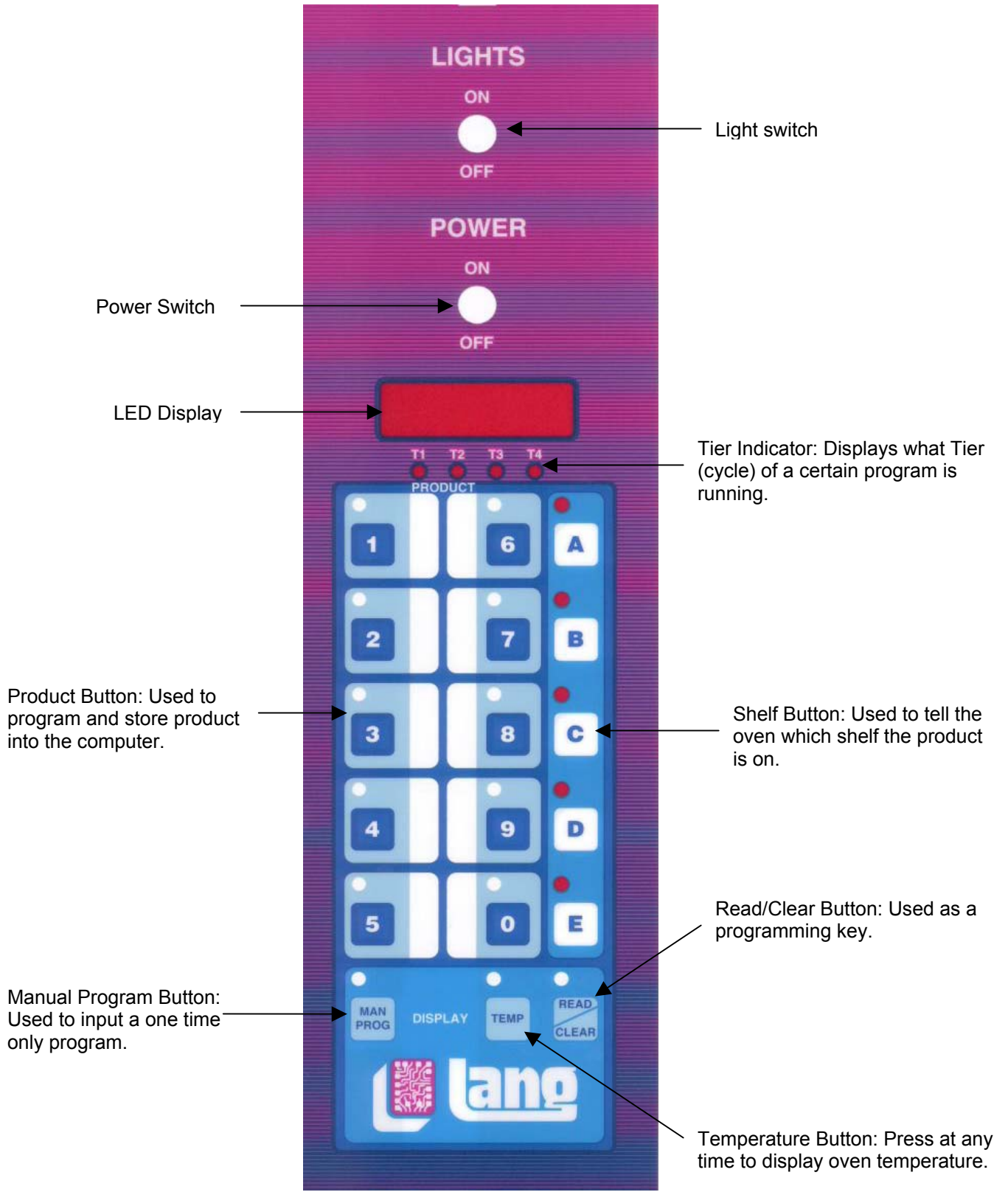

# CONTROL PANEL LAYOUT ECCO-PP

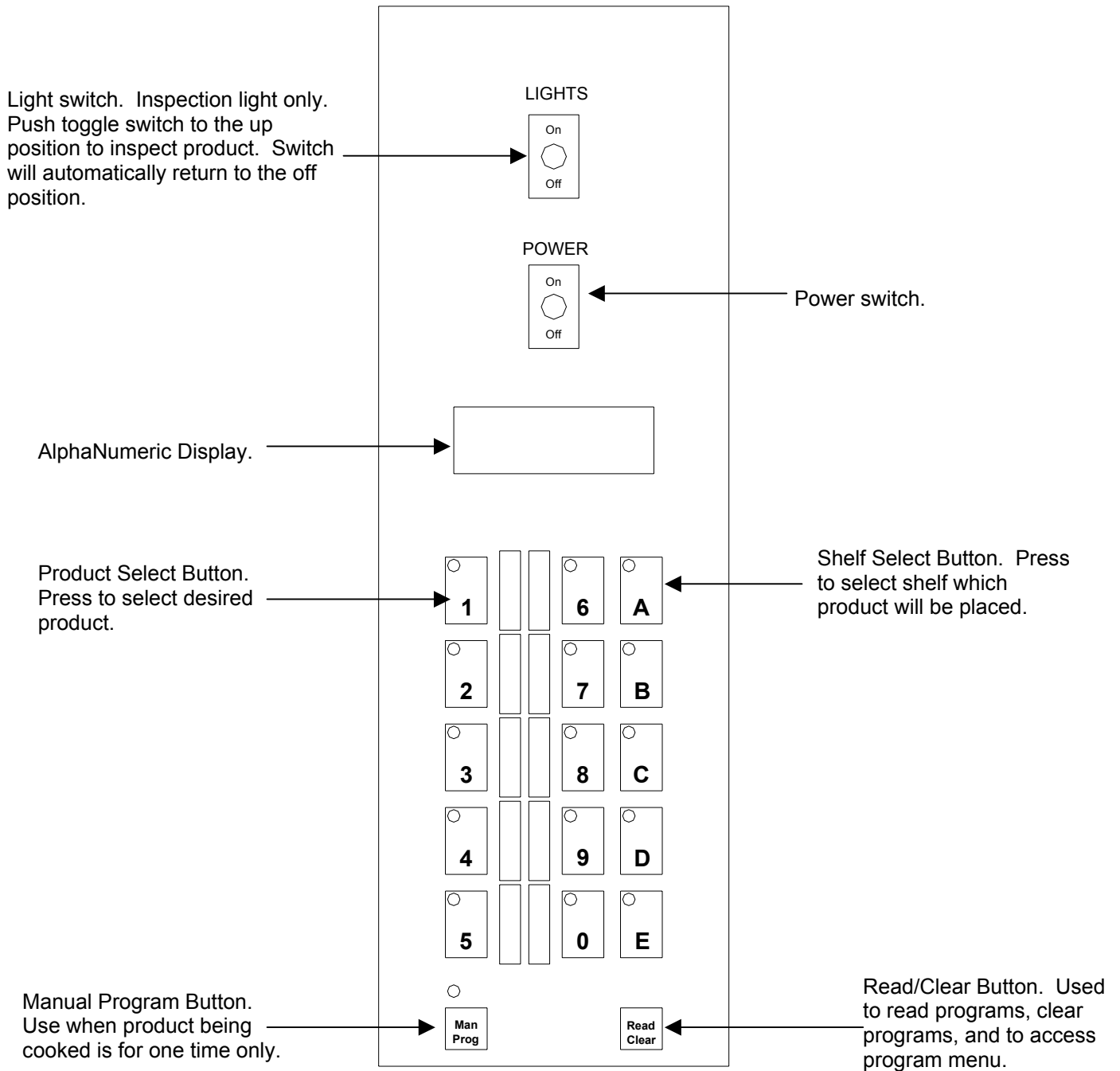

# CONTROL PANEL LAYOUT ECCO-PT

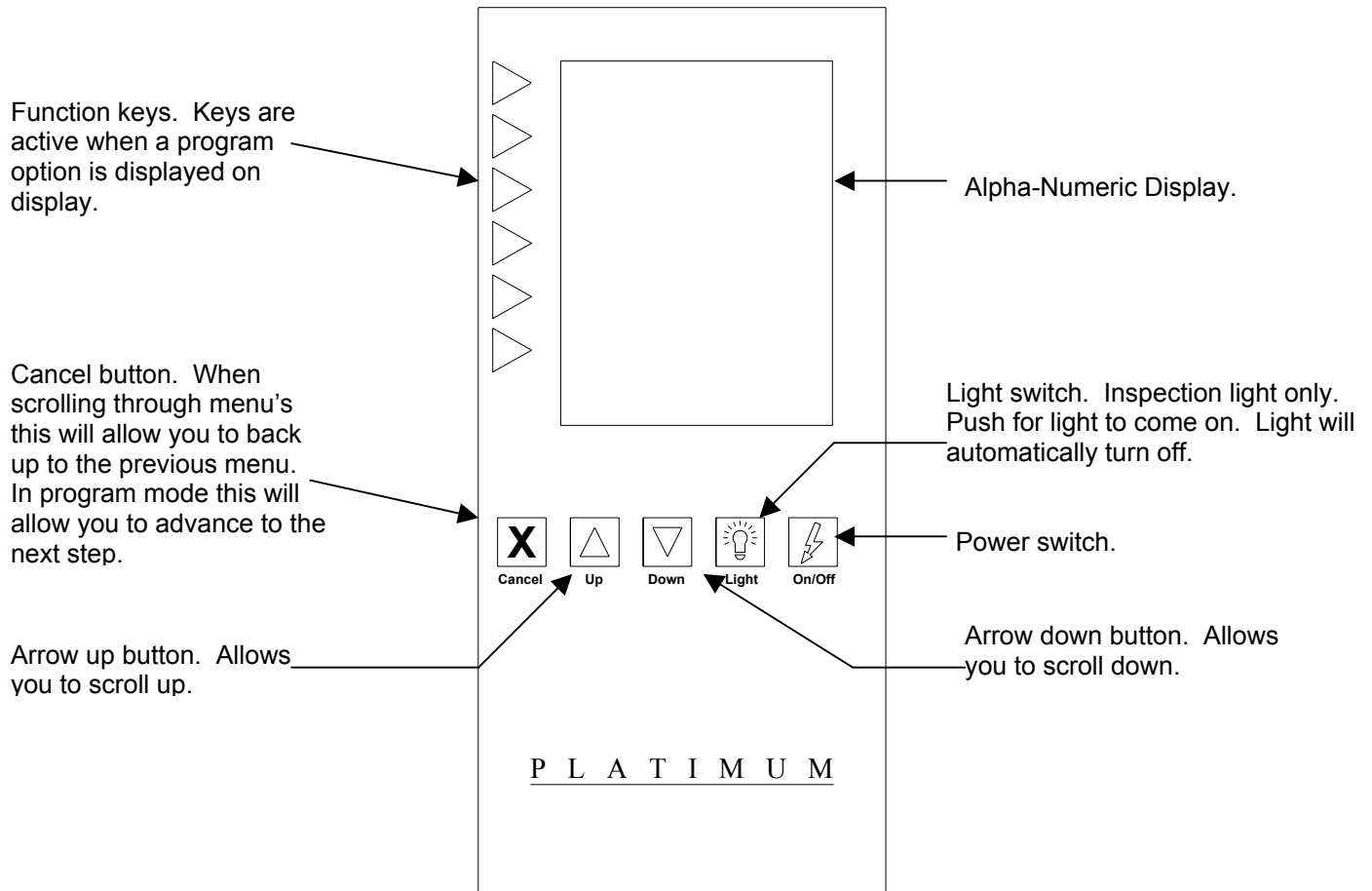

## CONTROL PANEL BUTTONS

- 1 -0** Product Buttons. These are the buttons where the product programs are stored. Pressing a Product Button will heat the oven to the programmed temperature.
- A - E** Shelf Buttons. The control is capable of timing each shelf individually. Pressing a Product Button then a Shelf Button will start the countdown timer.
- Man Prog** The MANUAL PROGRAM button allows the operator to enter a temporary product program without being required to input the programming code. The temporary program is erased when the oven is turned off or when a new program is entered. Time and temperature are the only parameters that can be entered in the Manual Program mode.
- READ/CLEAR** The READ/CLEAR button has several functions.
- It is always the first button pressed when entering programming codes.
  - Pressing it twice then pressing a Product Button will "read-back" the program in that product button.
  - Pressing and holding the button down until "88888" appears in the display will cancel the current mode of the control and return the display to "EntEr".
- Temp** When the Temperature Recall Button is pressed, the display will indicate the internal oven temperature. When released the display will revert to the previous readout.

## PROGRAMMING TERMS

- COOKING CURVE** Cooking curve is a function of the computer that controls the cooking time. If the temperature of the oven is lower than the programmed temperature, the control will slow the timer down to compensate for the lower cooking temperature. Cooking Curves from 0 - no time adjustment to 7 - maximum adjustment are available. Cooking Curve 3 is the most commonly used. However, as a general rule the longer the cooking time the lower the cooking curve, the shorter the cooking time the higher the cooking curve.
- FAN FUNCTION** The convection fan has two programmable options. Fan On (Fan 1) runs the convection fan continuously. Fan Off (Fan 0) leaves the fan off until heat is called for by the control. In a convection oven, the fan must come On whenever the heat comes On. The convection fan cannot be turned Off continuously.
- TIER** "Tiered" programming is the ability to change the cooking temperature or fan function during the cooking cycle. As an example, some products require the fan to be Off for the first half of the cooking cycle then turn On for the last half, Tier 1 would be programmed with the fan in the Off mode then Tier 2 would be fan On. The Tier lamps located below the display (labeled T1, T2, T3, and T4) will illuminate to indicate which Tier is being programmed or which Tier the program is in during the cooking cycle.

# PROGRAMMING ECCO-C

## PROGRAMMING

<b>ACTION</b>	<b>DISPLAY</b>
Turn the power switch on. If the oven is already on, turn it off and then back on.	<i>EntEr</i>
Quickly enter access code “ <b>R/C 1 6 2 7 3 8</b> ”. Do not hold the <b>R/C</b> button.	<i>Prod</i>
Select a Product number from <b>0-9</b> .	<i>St: 00</i>
Select amount of time that product should steam. If no steam is required press the shelf “ <b>A</b> ” button to advance to the next step. <b>Note:</b> If oven is not strapped for steam convection then this step will not be provided.	<i>000°F</i>
Select a Temperature from <b>150°F-450°F</b> . NOTE: Entering “ <b>000</b> ” will erase the existing program.	<i>cc0-7</i>
Select the desired cooking curve from 0-7.	<i>FAno 12</i>
Enter a desired Fan setting. “ <b>0</b> ” ( <i>noFRn</i> ) Will make the fan pulse with the heat. “ <b>1</b> ” ( <i>FRnonh 1</i> ) Will make the fan run on high continuously. “ <b>2</b> ” ( <i>FRnonLo</i> ) Will make the fan run on low continuously.	<i>00: 00: 00</i>
Enter the desired cooking time (hours:minutes:seconds)	<i>000°F</i>
The program is now entered for a single tier program, press the “ <b>E</b> ” button to continue programming other products. If the program is a multi tiered program continue by programming the next tiers. When complete press the “ <b>E</b> ” button.	<i>Prod</i>
When the programs have been completely entered press the “ <b>R/C</b> ” button to save and exit the programming cycle.	<i>EntEr</i>

## ECCO-C STATUS DISPLAY

The Status Display informs the operator of the oven's status.

It can be used as a countdown timer, shelf in use or internal oven temperature display during the cooking cycle (see ECCO-C Programming Codes pg. 16).

The Display informs the operator when the oven is ready to bake, or if the oven is above or below the programmed temperature.

Below is a list of displays and their definitions:

"EntEr"	The oven is energized and ready for an operator command.
"PrEht"	Stands for "PREHEAT". A product has been selected and the oven is heating to the programmed temperature.
"rERdy"	A product has been selected and the oven has preheated to the programmed temperature. The oven is ready to load a product.
"cool"	The oven's internal temperature is below what is programmed.
"hot"	The oven's internal temperature is above what is programmed.
"ShELF"	A product selection has been made after the oven has preheated and the computer is asking which shelf the product is placed on.
"hELP"	There is a fault in the control system, the computer will not operate until service is performed.
"cont"	Stands for "CONTINUOUS". The oven has been programmed without a time being entered. The oven will operate continuously at the programmed temperature.
"Error"	An entry has been made during the programming, which the computer does not understand.

## ECCO-C PROGRAMMING CODES

Below are codes, which will allow you to configure the display or aid in the operation, and troubleshooting of the oven.

The readout must display "**EntEr**" before the computer will accept any programming code. If the readout displays any other word, reset the computer by pressing and holding the "**R/C**" button until display reads "**BBBBB**" then release. Display should now read "**EntEr**".

The control allows for a 3-second delay between each button push, if a delay of longer than 3 seconds has occurred, the programming code must be re-entered.

The instructions call for pressing exactly what is shown under "PRESS".

<u>CODE DESCRIPTION</u>	<u>PRESS</u>
• <b>OPERATIONAL</b>	
Recall time remaining on a shelf	Shelf
Cancel a shelf timer	R/C, R/C, Shelf
• <b>DISPLAY MODES</b>	
Countdown timer display	R/C,4,8,4,8,4,8
Shelf in use display	R/C,0,9,0,9,0,9
Internal oven temperature display	R/C,8,7,8,7,8,7
• <b>PROGRAMMING</b>	
Enter programming mode	R/C,1,6,2,7,3,8
Recall an existing product program	R/C, R/C, P (Product programmed)
Erase a product program	R/C,1,6,2,7,3,8 (P) (000)
Model identification	R/C, D,C,D,C,D,C
Fan Setting ( HI or Both)	R/C,E,D,C,B,A,1(high),2 (both)
Program download (Contact Factory)	R/C, A, B, C, D, E, P
• <b>MAINTENANCE</b>	
Actual oven temperature	R/C,3,4,5,6,7,8
Return to ENTER	R/C
• <b>SHELF COMPENSATION</b>	
Enter shelf compensation mode	R/C, C, B, C, B, C, B
Set shelf compensations	(I.E.) A,2,3,A
Return to ENTER	R/C

# PROGRAMMING ECCO-PP

ACTION	DISPLAY
Turn the power switch on. If the oven is already on, press the Read / Clear key until the following screen is displayed.	<b>SELECT PRODUCT OR READ/CLEAR TO PROGRAM</b> <b>XX:XXPM      XXXF</b>
Enter access code "1 6 2 7 3 8".	<b>A: SET TIME</b> <b>B: SET DATE</b> <b>C: PROGRAM PRODUCTS</b> <b>D: NEXT MENU</b>
Select "C".	<b>PRODUCT PROGRAM MODE</b> <b>SELECT PRODUCT NUMBER 0-9</b>
Select a number from 0-9 and press the key corresponding to that number. NOTE: If a product Key selected already has a program, the screen will read.	<b>EDIT PRODUCT?</b> <b>1=EDIT OR 2=DELETE</b> <b>NXX TX XXXF CX</b> <b>XX:XX:XX PXXX F-XX</b>
If a product Key dose not have a program, the screen will read.	<b>ENTER COOKING TEMP</b> <b>100 TO 450 F</b> <b>NOX    T1    XXXF</b>
Enter a desired cooking / baking temperature. The screen will automatically advance to the next display.	<b>ENTER COOKING TIME</b> <b>HR:MIN:SEC</b> <b>NOX    T1    XXXF    CO</b>
Enter the cooking time and then press "E" to advance to the next screen.	<b>ENTER COOKING CURVE</b> <b>0 TO 100%</b> <b>NOX    T1    XXXF    CXX</b> <b>XX:XX:XX PXXX F-XX</b>
Enter the desired cooking curve. (Refer to sections 6.3 and 6.7 for more detail)	<b>ENTER FAN SPEED</b> <b>1=HI    2=LOW</b> <b>NOX    T1    XXXF    CXX</b> <b>XX:XX:XX PXXX F-XX</b>
Select Fan speed. (Hi=1700 rpm, Low=1400)	<b>ENTER FAN PULSE RATE</b> <b>1 TO 100%</b> <b>NOX    T1    XXXF    CXX</b> <b>XX:XX:XX PXX F-XX</b>
Select Fan Pulse rate. (0 to 100%). 0=off unless calling for heat. 100=on at all time. <b>NOTE:</b> Any number between 0-100 means that the fan will be on that many number of seconds in a 100-second block. (E.g. 67%= on for 67 seconds in a 100 second block)	<b>CONTINUE TO TIER 2</b> <b>1=YES 2=NO</b> <b>NOX    T1    XXXF    CXX</b> <b>XX:XX:XX PXXX F-XX</b>
If your press 1 you will go through the same sequence as outlined above. If you press 2 the next display will automatically appear.	<b>A: SET TIME</b> <b>B: SET DATE</b> <b>C: PROGRAM PRODUCTS</b> <b>D: NEXT MENU</b>

# PROGRAMMING ECCO-PT

ACTION	DISPLAY								
<p>Step 1. Turn the power switch on. If the oven is already on, press the <b>"CANCEL"</b> key until the following screen is displayed.</p> <p>Step 2. Select:</p> <p style="text-align: center;">← TIME / DATE / PROGRAM.</p>	  ← RUN OVEN  ← TIME / DATE / PROGRAM <table style="width: 100%; margin-top: 10px;"> <thead> <tr> <th style="width: 25%;">TIME</th> <th style="width: 25%;">DATE</th> <th style="width: 25%;">TEMP</th> <th style="width: 25%;">STATUS</th> </tr> </thead> <tbody> <tr> <td>12:00</td> <td>01/01/01</td> <td>325</td> <td>STANDBY</td> </tr> </tbody> </table>	TIME	DATE	TEMP	STATUS	12:00	01/01/01	325	STANDBY
TIME	DATE	TEMP	STATUS						
12:00	01/01/01	325	STANDBY						

ACTION	DISPLAY								
<p>Step 3. Select :</p> <p style="text-align: center;">← PROGRAM COMPUTER</p>	← DISPLAY PRODUCT  ← TIMER ONLY  ← SET TIME / DATE  ← PROGRAM COMPUTER <table style="width: 100%; margin-top: 10px;"> <thead> <tr> <th style="width: 25%;">TIME</th> <th style="width: 25%;">DATE</th> <th style="width: 25%;">TEMP</th> <th style="width: 25%;">STATUS</th> </tr> </thead> <tbody> <tr> <td>12:00</td> <td>01/01/01</td> <td>325</td> <td>PROGRAM</td> </tr> </tbody> </table>	TIME	DATE	TEMP	STATUS	12:00	01/01/01	325	PROGRAM
TIME	DATE	TEMP	STATUS						
12:00	01/01/01	325	PROGRAM						

ACTION	DISPLAY
<p>Step 4. Using the ▲ and ▼ arrows, enter access code <b>"A B C D E F"</b></p> <p>Press ▲ or ▼ to scroll through letters and numbers, then select <b>"ENTER"</b> to move the cursor to the right.</p> <p><i>EXAMPLE: Press ▲ once for an "A", then press "ENTER". Press ▲ twice for a "B", then select "ENTER". Continue through "F". The screen will then automatically advance once access code has been entered correctly.</i></p>	<div style="border: 1px solid black; border-radius: 15px; padding: 5px; display: inline-block; margin-bottom: 20px;">ENTER ACCESS CODE</div> <p>USE ▲▼ KEYS TO SELECT THEN PRESS ENTER</p>  ← ENTER <p style="margin-top: 20px;">PRESS CANCEL TO QUIT</p>

# PROGRAMMING ECCO-PT CONT'D

ACTION	DISPLAY
<p>Step 5. Select:</p> <p style="text-align: center;">← PROGRAM PRODUCTS</p>	<p>← PROGRAM PRODUCTS</p> <p>← EDIT READY ZONE</p> <p>← EDIT ACCESS CODE</p> <p>← ENABLE MANUAL PRODUCT</p> <p>← CONFIGURE TIME OF DAY</p>

ACTION	DISPLAY
<p>Step 6. Select:</p> <p style="text-align: center;">← CREATE NEW PRODUCT</p>	<p>← CREATE NEW PRODUCT</p> <p>← EDIT PRODUCT</p> <p>← DELETE PRODUCT</p> <p>← EDIT PRODUCT</p>

ACTION	DISPLAY
<p>Step 7. "SELECT PRODUCT ICON" is the first screen when creating a product program. Press ▼ until you find an icon that best resembles your product. If necessary, press ▲ to go backward through the icon list. Select "ENTER" to accept the icon, and more to the next screen</p>	<p style="text-align: center;">SELECT PRODUCT ICON</p> <p style="text-align: center;">USE ▲▼ KEYS TO SELECT THEN PRESS ENTER TO ACCEPT</p> <div style="display: flex; align-items: center; margin-top: 10px;">  <p>APPETIZER A</p> </div> <p>← ENTER</p>

# PROGRAMMING ECCO-PT CONT'D

ACTION	DISPLAY
<p>Step 8. <b>“SELECT PRODUCT NAME”</b> is where you spell the name using the <b>▲</b> or <b>▼</b> to select each letter. Then select <b>“ENTER”</b> to move the cursor to the next space and select a new letter.</p> <p>NOTE: <b>“<u>A</u>PPETIZER A”</b> is the name that must be replaced with the new product name or blanks, when the product name is shorter than <b>“<u>A</u>PPETIZER A”</b>.</p> <p><i>EXAMPLE: “APPLE” replaces only <u>APPET</u>, <u>IZER A</u> must be replace by blanks. A blank can be found before “A” or after “9” when scrolling.</i></p>	<div style="text-align: center; border: 1px solid black; border-radius: 15px; padding: 5px; margin-bottom: 10px;"> <b>SELECT PRODUCT NAME</b>  <u>A</u>PPETIZER A         </div> <p style="text-align: center;">USE ▲▼ KEYS TO SELECT</p> <div style="display: flex; align-items: center; margin-bottom: 10px;"> <b>APPETIZER A</b> </div> <div style="display: flex; flex-direction: column; gap: 5px;"> <span>◀ ACCEPT</span> <span>◀ ENTER</span> </div>

ACTION	DISPLAY
<p>Step 9. <b>“SELECT PRODUCT TEMPERATURE”</b>            Press the <b>▲</b> or <b>▼</b> to select a number. Then select <b>“ENTER”</b> to move the cursor to the next space and select a new number. The screen will automatically advance after you enter the last number.</p> <p><i>EXAMPLE: (320) Press ▲ three times for a “3”, then select “ENTER” to advance the cursor. Press ▲ two times for a “2”, then select “ENTER” to advance the cursor. Since “0” is already displayed just select “ENTER” to advance to the next screen.</i></p>	<div style="text-align: center; border: 1px solid black; border-radius: 15px; padding: 5px; margin-bottom: 10px;"> <b>SELECT PRODUCT TEMPERATURE</b>            100         </div> <p style="text-align: center;">USE ▲▼ KEYS TO SELECT</p> <div style="display: flex; align-items: center; margin-bottom: 10px;"> <b>APPLE</b> </div> <p><b>TIER 1</b></p> <div style="display: flex; flex-direction: column; gap: 5px;"> <span>◀ ACCEPT</span> <span>◀ ENTER</span> </div>

ACTION	DISPLAY
<p>Step 10. <b>“SELECT TIER COOK TIME”</b>. Time is entered in hours:minutes:seconds. The maximum is 12:59:59. Select <b>“ENTER”</b> to advance cursor to the place you want to enter a number.</p> <p><i>EXAMPLE: (45 minutes:00 seconds) Select “ENTER” twice to advance from hours to minutes, then press ▲ four times for a “4”, then select “ENTER” to advance the cursor. Then press ▲ five times for a “5”, then select “ENTER” to advance the cursor. Since “0” is the next two numbers simply select “ENTER” again twice to advance the cursor.</i></p>	<div style="text-align: center; border: 1px solid black; border-radius: 15px; padding: 5px; margin-bottom: 10px;"> <b>SELECT TIER COOK TIME</b>            00:45:00         </div> <p style="text-align: center;">USE ▲▼ KEYS TO SELECT</p> <div style="display: flex; align-items: center; margin-bottom: 10px;"> <b>APPLE</b> </div> <p><b>TIER 1</b> <b>TEMP: 320F</b></p> <div style="display: flex; flex-direction: column; gap: 5px;"> <span>◀ ACCEPT</span> <span>◀ ENTER</span> </div>

# PROGRAMMING ECCO-PT CONT'D

ACTION	DISPLAY
<p>Step 11. <b>“SELECT COOKING CURVE”</b>. Press <b>▲</b> or <b>▼</b> to select numbers, select <b>“ENTER”</b> to move the cursor to the next space. Cooking curve may be any number between 0% and 100%.</p> <p><i>EXAMPLE: (80%) Select “ENTER” once to advance the cursor one space, then press ▲ eight times for a “8”. Select “ENTER” to advance the cursor. Since “0” is the next number, select “ENTER” to advance to the next screen.</i></p>	<div style="border: 1px solid black; border-radius: 50%; padding: 10px; display: inline-block;"> <p><b>SELECT COOKING CURVE</b> 000 %</p> </div> <p>USE ▲▼ KEYS TO SELECT</p> <div style="display: flex; align-items: center; margin-top: 10px;"> <p><b>APPLE</b></p> </div> <div style="margin-top: 10px;"> <p><b>TIER 1</b> <b>TEMP: 320F</b>                      <b>TIME: 00:45:00</b></p> </div> <div style="margin-top: 10px;"> <p>⏪ <b>ACCEPT</b> ⏪ <b>ENTER</b></p> </div>

ACTION	DISPLAY
<p>Step 12. <b>“SELECT FAN SPEED”</b>. The cursor will automatically appear under <b>HIGH</b>, that is your default setting. Press <b>“ENTER”</b> or <b>ACCEPT</b> to keep high fan and advance to the next screen. If <b>LOW</b> is the correct setting press the <b>▲</b> or <b>▼</b> to move the cursor to low. Once low is selected, select <b>“ENTER”</b> or <b>ACCEPT</b> to move to the next screen.</p>	<div style="display: flex; justify-content: space-between; align-items: center;"> <p><b>HIGH</b></p> <div style="border: 1px solid black; border-radius: 50%; padding: 10px; display: inline-block;"> <p><b>SELECT FAN SPEED</b></p> </div> <p><b>LOW</b></p> </div> <p>USE ▲▼ KEYS TO SELECT</p> <div style="display: flex; align-items: center; margin-top: 10px;"> <p><b>APPLE</b></p> </div> <div style="margin-top: 10px;"> <p><b>TIER 1</b> <b>TEMP: 320F</b>                      <b>TIME: 00:45:00</b></p> </div> <div style="margin-top: 10px;"> <p><b>COOKING CURVE: 80 %</b></p> </div> <div style="margin-top: 10px;"> <p>⏪ <b>ACCEPT</b> ⏪ <b>ENTER</b></p> </div>

# PROGRAMMING ECCO-PT CONT'D

ACTION	DISPLAY
<p>Step 13. <b>"SELECT PULSE RATE"</b>. Press <b>▲</b> or <b>▼</b> to select numbers, select <b>"ENTER"</b> to move the cursor to the next space. 100% is the default. If this okay, select <b>"ENTER"</b> three times or <b>"ACCEPT"</b> once to advance to the next screen.</p> <p><i>EXAMPLE: (80%) Press the ▼ once for "0". Select "ENTER" once to advance the cursor one space, then press ▲ eight times for a "8". Select "ENTER" to advance the cursor. Since "0" is the next number, select "ENTER" to advance to the next screen.</i></p>	<div style="border: 1px solid black; border-radius: 50%; width: 150px; height: 40px; margin: 0 auto; display: flex; align-items: center; justify-content: center;"> <p><b>SELECT PULSE RATE</b> <b>100 %</b></p> </div> <p><b>USE ▲▼ KEYS TO SELECT</b></p> <div style="display: flex; align-items: center; margin-top: 20px;"> <p><b>APPLE</b></p> </div> <div style="margin-top: 20px;"> <p><b>TIER 1</b></p> <p><b>TEMP: 320F</b>                      <b>TIME: 00:45:00</b></p> <p><b>FAN: HI</b></p> <p><b>COOKING CURVE: 80 %</b></p> </div> <div style="margin-top: 20px;"> <p>◀ <b>ACCEPT</b></p> <p>◀ <b>ENTER</b></p> </div>

ACTION	DISPLAY
<p>Step 14. <b>"CORRECT"</b>. The cursor automatically appears on <b>"YES"</b>. The computer is asking if the program displayed is correct. If any part of that program is incorrect, press <b>▲</b> or <b>▼</b> till the cursor is on <b>"NO"</b>. Select <b>"ENTER"</b> or <b>"ACCEPT"</b>. This will return you to step 7. Selecting <b>"YES"</b> will advance the screen. <b>"NO"</b>.</p>	<div style="display: flex; justify-content: space-between; width: 100%;"> <p><b>YES</b></p> <div style="border: 1px solid black; border-radius: 50%; width: 150px; height: 40px; margin: 0 auto; display: flex; align-items: center; justify-content: center;"> <p><b>CORRECT?</b></p> </div> <p><b>NO</b></p> </div> <p><b>USE ▲▼ KEYS TO SELECT</b></p> <div style="display: flex; align-items: center; margin-top: 20px;"> <p><b>APPLE</b></p> </div> <div style="margin-top: 20px;"> <p><b>TIER 1</b></p> <p><b>TEMP: 320F</b>                      <b>TIME: 00:45:00</b></p> <p><b>FAN: HI</b>                              <b>RATE: 100 %</b></p> <p><b>COOKING CURVE: 80 %</b></p> </div> <div style="margin-top: 20px;"> <p>◀ <b>ACCEPT</b></p> <p>◀ <b>ENTER</b></p> </div>

# PROGRAMMING ECCO-PT CONT'D

ACTION	DISPLAY						
<p>Step 15. <b>"CONTINUE TO NEXT TIER"</b>. The cursor automatically appears on <b>"NO"</b>. Select <b>"ENTER"</b> or <b>"ACCEPT"</b> to end programming or move the cursor with the <b>▲</b> or <b>▼</b> to <b>"YES"</b>. This will allow you to enter another tier to this program. Repeat steps 6-14 to program second tier.</p>	<p><b>CONTINUE TO NEXT TIER</b></p> <p><b>YES</b> <span style="float: right;"><b>NO</b></span></p> <p>USE ▲▼ KEYS TO SELECT</p> <div style="display: flex; align-items: center; justify-content: center; margin: 10px 0;"> <p><b>APPLE</b></p> </div> <p><b>TIER 1</b></p> <table style="width: 100%; border: none;"> <tr> <td style="width: 33%;">TEMP: 320F</td> <td style="width: 33%;">TIME: 00:45:00</td> </tr> <tr> <td>FAN: HI</td> <td>RATE: 100 %</td> </tr> <tr> <td colspan="2">COOKING CURVE: 80 %</td> </tr> </table> <p>◀ <b>ACCEPT</b>          ▶ <b>ENTER</b></p>	TEMP: 320F	TIME: 00:45:00	FAN: HI	RATE: 100 %	COOKING CURVE: 80 %	
TEMP: 320F	TIME: 00:45:00						
FAN: HI	RATE: 100 %						
COOKING CURVE: 80 %							

ACTION	DISPLAY
<p>Step 16. After programming the last tier, select <b>"NO"</b> when asked <b>"CONTINUE TO NEXT TIER"</b> the computer will automatically advance the screen to program more products. If no other products need to be programmed, select <b>"CANCEL"</b> three times to advance screen to the boot up screen.</p>	<p>◀ <b>CREATE NEW PRODUCT</b></p> <p>◀ <b>EDIT PRODUCT</b></p> <p>◀ <b>DELETE PRODUCT</b></p> <p>◀ <b>EDIT PRODUCT</b></p>

ACTION	DISPLAY								
<p>Step 17. You may now preheat the oven for any products you have programmed.</p> <p>Step 18. Select:</p> <p style="margin-left: 40px;">◀ <b>Run oven</b></p>	<p>◀ <b>RUN OVEN</b></p> <p>◀ <b>TIME / DATE / PROGRAM</b></p> <table style="width: 100%; border: none; margin-top: 20px;"> <thead> <tr> <th style="text-align: left;">TIME</th> <th style="text-align: left;">DATE</th> <th style="text-align: left;">TEMP</th> <th style="text-align: left;">STATUS</th> </tr> </thead> <tbody> <tr> <td>12:00</td> <td>01/01/01</td> <td>325</td> <td>STANDBY</td> </tr> </tbody> </table>	TIME	DATE	TEMP	STATUS	12:00	01/01/01	325	STANDBY
TIME	DATE	TEMP	STATUS						
12:00	01/01/01	325	STANDBY						

## **OPERATIONS**

- Convection ovens constantly circulate air over the product. This strips away the thin layer of moisture and cool air from the top of the product. Heat penetrates more quickly. Cooking times are shortened and cooking temperatures are usually reduced.
- To convert standard deck oven recipes to convection oven recipes, reduce the temperature 50 °F and the time by 25%. Make adjustments as necessary, depending upon your results.
- The lower the temperature the more even the bake.
- Check the product halfway through the baking cycle. Look through the door windows. Opening the oven door is not recommended.
- If products are brown on the outside and not done on the inside, too high a temperature is being used. Decrease the temperature 15-25 °F.
- If products are pulling to the edge of pans or spilling, the oven is not leveled or the pans are warped. Correct as necessary.
- Load each shelf evenly. Spaces should be maintained equally between the pan and walls. Front and back. This will allow an even distribution of airflow.

## **BAKING**

- Most baking should be done with the vent closed. Open the vent only with high moisture products to avoid seepage around the front of the door.
- Always weigh your product. This will give you a more consistent size, color and quality.
- Center the pan in the oven. The better the air flow around the product, the better the bake.
- The convection oven is a mechanical piece of equipment. The same control settings will always give the same results. If the results vary, problems may be because of preparation, not the oven.

## **LOADING**

- Place product as close to oven as practical. Open oven doors and load quickly but carefully.
- If only one pan is required, load on center shelf. If two pans are required, load on second and fourth shelf. If three pans are required, load on top shelf, bottom shelf, and center shelf. If four pans are required, load on top shelf, bottom shelf, and middle two shelves. If five shelves are required, space evenly in oven. (See page 27 for more detail)

## **UNLOADING**

- It is a characteristic of all convection ovens to unload the top shelf before the bottom shelves. The rising of heat and the hot oven ceiling causes the top shelf to bake quicker. This characteristic is more pronounced when baking at higher temperatures and/or for prolonged periods of time.

**GENERAL CONT'D**

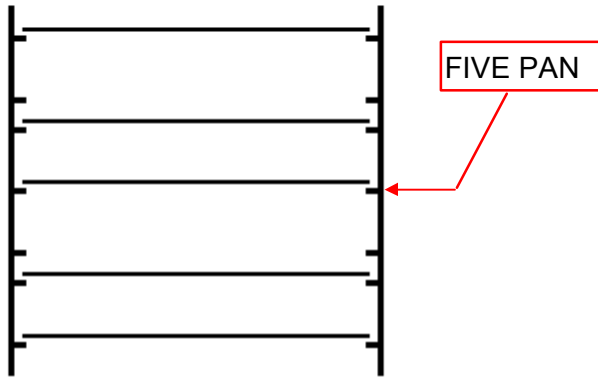
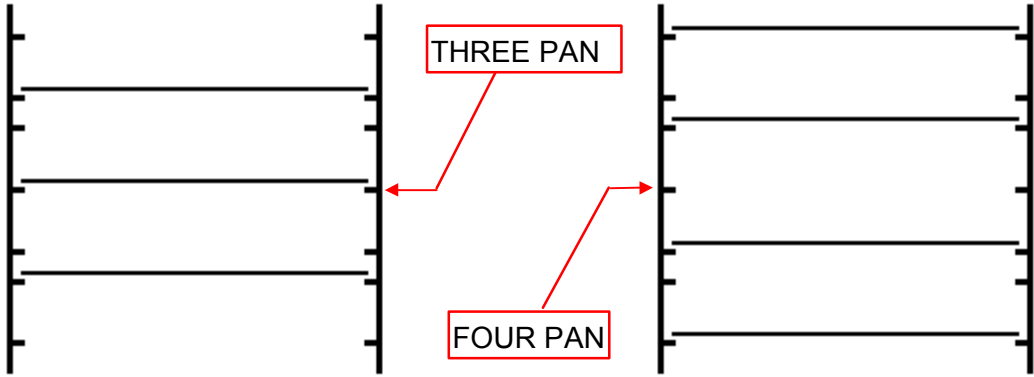
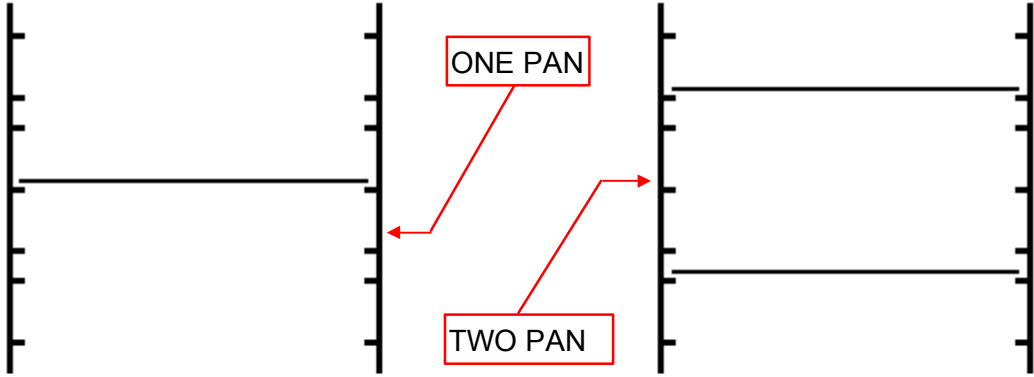

# TYPICAL OPERATION

## ECCO-T

ACTION	RESULT
Turn power switch to ON.	
Adjust proper temperature, between 140 & 450 degrees and allow to preheat up to 20 minutes.	Oven begins heating.
Open oven doors and insert product, set timer up to 60 minutes.	Timer begins counting down.
Timer beeps continuously when done.	Product should now be done.

## ECCO-AP

ACTION	RESULT
Turn power switch to ON.	Control panel heat call light comes on.
Adjust proper temperature, between 140°F & 450°F and allow to preheat up to 20 minutes.	Oven begins heating.
Open oven doors and insert product, set timer up to 60 minutes.	Timer begins counting down.
Timer beeps continuously when done.	Product should now be done.

## ECCO-SII

ACTION	RESULT
Turn power switch to ON.	Digital display reads "000" .
Press Temp button and use arrows to adjust to proper Temp between 150°F & 450°F.	Oven begins heating and displays "PrE".
<i>Beeper will sound for 3 seconds when preheated.</i> Open doors and insert product.	Display will read preheated temperature.
Press Time Button and use arrows to adjust to desired time. Press Start / Stop Button.	Digital display will start countdown.
<i>Beeper sounds continuously</i> Press Start / Stop Button.	

## TYPICAL OPERATION CONT'D

### ECCO-C

ACTION	RESULT
Turn power switch to ON.	Control panel comes on, display says “ <b>BBBBB</b> ” and then “ <b>EntEr</b> ”, motor starts.
Press a product button.	Display says “ <b>PrEHt</b> ” (Preheat), oven begins to heat to the programmed temperature.
<i>Beeper sounds briefly.</i>	Display says “ <b>rERdy</b> ”.
Open the oven doors and load the product. Close the door and press the product button again.	Beeper sounds briefly and display says “ <b>ShELF</b> ”.
Press the shelf button(s) which correspond to the shelf positions which the product is loaded (A equals the top shelf and E equals the bottom shelf).	Display shows a countdown timer and begins to count toward zero.
<i>Beeper sounds continuously.</i>	Display shows “ <b>donE</b> ”, shelf button(s) flash.
Press the <b>flashing</b> shelf button(s).	Beeper stops. Display shows “ <b>rERdy</b> ” if no other shelves carry product or resume count down for shelves that still have product cooking.
Open oven door and remove the product, which corresponds to flashing shelf button(s).	

### ECCO-PP

ACTION	RESULT
Turn power switch to ON.	Control panel comes on, display says “ <b>SELECT PRODUCT OR READ/CLEAR TO PROGRAM.</b> ”
Press a product button.	Display says “ <b>PRODUCT X PREHEATING TO XXX F</b> ”. Motor starts and oven begins preheating to the programmed temperature.
<i>Beeper sounds briefly.</i>	Display says “ <b>READY SELECT PRODUCT TO START</b> ”.
Open the oven doors and load the product. Close the door and press the product button again.	Beeper sounds briefly and display says “ <b>SELECT OVEN SHELVES PRODUCT X</b> ”.
Press the shelf button(s) which correspond to the shelf positions, which the product is loaded (A equals the top shelf and E equals the bottom shelf).	Display shows a countdown timer and begins to count toward zero.
<i>Beeper sounds continuously.</i>	Display shows “ <b>DONE PRESS SHELF BUTTON X, REMOVE PRODUCT</b> ”, shelf button(s) flash.
Press the <b>flashing</b> shelf button(s).	Beeper stops. Display shows “ <b>READY SELECT PRODUCT TO START</b> ” if no other shelves carry product or resume count down for shelves that still have product cooking.
Open oven door and remove the product, which corresponds to flashing shelf button(s).	

## TYPICAL OPERATION CONT'D

### ECCO-PT

ACTION	RESULT
Press the on switch.	Control panel comes on, display says <b>“LANG, Run Oven, Time Date Program.”</b>
Select <b>“Run Oven”</b> .	Display will show a list of product to choose.
Select Product button next to Icon desired.	Display says <b>“Preheating to XXXF”</b> .
<i>Beeper sounds briefly.</i>	Display says <b>“Ready”</b> .
Select Product to start.	Display shows possible product selection for that temperature.
Select Product to start.	Display says <b>“Select shelf”</b> .
Press Product button next to desired shelf.	Display will show icon chosen and begin to count down.
<i>Beeper sounds continuously.</i>	Display shows <b>“ DONE”</b> press button and remove product from that shelf.
Oven is ready for another product.	

## SEQUENCE OF OPERATION ECCO-T

### **Power switch turned on.**

240/208 VAC across Common terminals on power switch and “B” terminal of 12 pin

**Terminal block.**

240/208 VAC to Common terminals of **Motor relay.**

### **240/24-volt transformer energized.**

24 VAC across “C” and “D” (common) of 12 pin **Terminal block.**

24 VAC across coil of **Motor relay.** (Through door switch)

24 VAC across “D” and of **Heat contactor.** (Through door switch and high limit thermostat)

Motor contactor closes.

### **Motor starts.**

#### **Thermostat Turned On**

24 VAC across coil of **Heat contactor.**

**Heat contactor** closes.

208/240 volts to elements.

Oven heats.

## SEQUENCE OF OPERATION ECCO-AP

### **Power switch turned on.**

240/208 VAC across Common terminals on power switch and “B” terminal of 12 pin

**Terminal block.**

240/208 VAC to Common terminals of **Motor relay.**

### **240/24-volt transformer energized.**

24 VAC across “C” and “D” (common) of 24 pin **Terminal block.**

24 VAC across coil of **Motor relay.** (Through door switch)

24 VAC across “D” and of **Heat contactor.** (Through door switch and high limit thermostat)

24 VAC across “D” and Heat output on board.

Motor contactor closes.

### **Motor starts.**

24 VAC across coil of **Heat contactor.**

**Heat contactor** closes.

208/240 volts to elements.

Oven heats.

## SEQUENCE OF OPERATION ECCO-SII

### **Power switch turned on.**

240/208 VAC across Common terminals on power switch and “B” terminal of 12 pin **Terminal block** (through fuses).

240/208 VAC to Common terminals of **Motor relay**.

### **240/24-volt transformer energized.**

24 VAC across “C” and “D” (common) of 24 pin **Terminal block**.

24 VAC across pins 1 & 2 on circuit board.

24VAC across Motor output on circuit board and “D”.

24 VAC across coil of **Motor relay** (through door switch).

Motor relay closes.

### **Motor starts.**

24 VAC across Heat output on circuit board and “D”.

24 VAC across coil of **Heat contactor** (through over temperature thermostat).

**Heat contactor** closes.

208/240 volts to elements.

Oven heats.

## SEQUENCE OF OPERATION ECCO-C

### **Power switch turned on.**

240/208 VAC across Common terminals on power switch and “A” terminal of 24 pin.

#### **Terminal block.**

240/208 VAC across any “A” and “B” terminal of 24 pin **Terminal block**.

240/208 VAC to Common terminals of **Motor relay**.

240/208 VAC across common terminals of **Back-up toggle switch**.

120 VAC to coil of **Back-up relay**.

### **240/24 volt transformer energized.**

24 VAC across “C” and “D” (common) of 24 pin **Terminal block**.

24 VAC across “D” and coil of **Motor relay**. (Through door switch)

24 VAC across “D” and of **Heat contactor**. (Through door switch and high limit thermostat)

24 VAC across “D” and Common terminals of **Back-up relay**.

240/12 volt transformer energized.

### **Back-up toggle switch Off.**

24 VAC across “D” and TP4, TP5 and TP6.

12 volts to TP1 on **microprocessor**.

24 VAC across coil of **motor contactor**.

Motor contactor closes.

240/208 VAC across NO (Normally open) contacts of **Motor relay**.

### **Motor starts.**

24 VAC across coil of **Heat contactor**.

**Heat contactor** closes.

208/240 volts to elements.

Oven heats.

### **Back-up toggle switch Off.**

208/240 VAC across coil of **Back-up relay**.

### **Back-up relay closes.**

24 VAC across and **Back-up Thermostat** (With door switch energized.)

24 VAC across coil of **Motor relay**.

Motor contactor closes.

240/208 VAC across NO (Normally open) contacts of **Motor relay**.

### **Motor starts.**

Temperature set on back up thermostat.

24 VAC across “D” and each terminal of back-up thermostat.

24 VAC across coil of **Heat contactor**.

Heat contactor closes.

208/240 volts to elements.

## SEQUENCE OF OPERATION ECCO-PP/PT

### **Oven plugged in.**

208/240 VAC across any “A” and “B” terminal on the terminal block.

208/240 VAC to Control transformer (208-240VAC / 24-12 VAC) and Component transformer 240VAC / 24VAC.

### **Transformers energize.**

24 VAC to any “C” and “D” terminal on the terminal block.

24 / 12 VAC to Circuit Board (JP40).

24 VAC to Circuit Board outputs (JP11- JP13).

### **Power Switched turned to “ON”.**

Display comes on.

### **Product selected.**

24 VAC across motor output (JP12) and “D”.

24 VAC across motor HI relay coil.

Motor relay closes.

208/240 VAC to motor.

### **Motor Starts.**

24 VAC across heat output (JP11) and “D”.

24 VAC across heat contactor (through over-temperature thermostat).

Heat contactor closes.

208/240 VAC to elements.

### **Back up toggle switch to “ON” .**

208/240 VAC across coil of back up relay coil.

### **Back up relay energizes.**

24 VAC to motor relay.

Motor relay energizes.

208/240 VAC to motor.

### **Motor Starts.**

24 VAC to thermostat.

### **Temperature set on thermostat.**

24 VAC to heat contactor.

Contactors energizes.

208/240 VAC to elements.

# TROUBLESHOOTING ECCO-T

**HINT:** Confirm that all Circuit Breakers are in the “ON” position.

## NO MOTOR

PROBABLE CAUSE	CORRECTIVE ACTION
Defective Fan Switch	➤ Verify that Fan switch is in “ON” position (In pulse position motor will only cycle when oven calls for heat).
Defective Fuses	➤ Check fuses for normal operation.
Defective Transformer	➤ Check transformer for normal operation. (See Technical Data for correct ratings)
Defective Motor Relay	➤ Check motor relay for normal operation. (24VAC 35 Ω)
Defective Door Switch	➤ Check door switch for normal operation.
Defective Motor	➤ Check motor for normal operation. (See Technical Data for correct ratings)

## NO HEAT

PROBABLE CAUSE	CORRECTIVE ACTION
Defective Elements	<ul style="list-style-type: none"> <li>➤ Check that elements are getting power.</li> <li>➤ Confirm that Elements are working correctly. (See Technical Data for amperage)</li> </ul>
Defective Transformer	<ul style="list-style-type: none"> <li>➤ Check transformer for normal operation. (See Technical Data for correct ratings)</li> <li>➤ Replace if necessary.</li> </ul>
Defective Heat Contactor	<ul style="list-style-type: none"> <li>➤ Confirm that Contactor is getting correct voltage.</li> <li>➤ Confirm that Contactor is operating properly. (24VAC 6Ω)</li> </ul>
Defective Thermostat	<ul style="list-style-type: none"> <li>➤ Confirm that Thermostat is getting 24 VAC. Measure between Thermostat terminal and “D” on the terminal block</li> </ul> <p><b>If voltage is not present:</b></p> <ul style="list-style-type: none"> <li>➤ Check Transformer for normal operation.</li> </ul> <p><b>If voltage is present:</b></p> <ul style="list-style-type: none"> <li>➤ Check thermostat for continuity.</li> <li>➤ Replace as necessary.</li> </ul>

# TROUBLESHOOTING ECCO-AP

**HINT:** Confirm that all Circuit Breakers are in the “ON” position.

## NO MOTOR

PROBABLE CAUSE	CORRECTIVE ACTION
Defective Fan Switch	➤ Verify that Fan switch is in “ON” position (In pulse position motor will only cycle when oven calls for heat).
Defective Fuses	➤ Check fuses for normal operation.
Defective Transformer	➤ Check transformer for normal operation.
Defective Motor Relay	➤ Check motor relay for normal operation. (24VAC 35 Ω)
Defective Door Switch	➤ Check door switch for normal operation.
Defective Motor	➤ Check motor for normal operation. (See Technical Data for correct ratings)

## NO HEAT

PROBABLE CAUSE	CORRECTIVE ACTION
Defective Elements	<ul style="list-style-type: none"> <li>➤ Check that elements are getting power.</li> <li>➤ Confirm that Elements are working correctly. (See Technical Data for correct ratings)</li> </ul>
Defective Transformer	<ul style="list-style-type: none"> <li>➤ Check transformer for normal operation. (See Technical Data for correct ratings)</li> <li>➤ Replace if necessary.</li> </ul>
Defective Probe	<ul style="list-style-type: none"> <li>➤ Confirm that probe has proper resistance for the correct temp. (See Technical Data for correct ratings)</li> </ul>
Defective Heat Contactor	<ul style="list-style-type: none"> <li>➤ Confirm that Contactor is getting correct voltage.</li> <li>➤ Confirm that Contactor is operating properly. (24VAC 6Ω)</li> </ul>
Defective Circuit board	<ul style="list-style-type: none"> <li>➤ Confirm that Heat Call light is on.</li> <li><b>If no light is detected:</b></li> <li>➤ Check 12-position switch for normal operation. (See Technical Data for correct ratings)</li> <li><b>If light is detected:</b></li> <li>➤ Check for 24VAC across heat output and “D” on 12 Pole terminal.</li> <li><b>If voltage is not present:</b></li> <li>➤ Replace Circuit board.</li> <li><b>If voltage is present:</b></li> <li>➤ Check over temperature thermostat for proper operation.</li> <li>➤ Check door switch for normal operation.</li> </ul>

# TROUBLESHOOTING ECCO-SII

**HINT:** Confirm that all Circuit Breakers are in the “ON” position.

## NO MOTOR

PROBABLE CAUSE	CORRECTIVE ACTION
<b>Defective Fan Switch</b>	<ul style="list-style-type: none"> <li>➤ Verify that Fan switch is in “ON” position (In pulse position motor will only cycle when oven calls for heat).</li> </ul>
<b>Defective Fuses</b>	<ul style="list-style-type: none"> <li>➤ Check Fuses for normal operation.</li> </ul>
<b>Defective Transformer</b>	<ul style="list-style-type: none"> <li>➤ Check Transformer for normal operation. (See Technical Data for correct ratings)</li> </ul>
<b>Defective Circuit board</b>	<ul style="list-style-type: none"> <li>➤ Check for 24 VAC across Motor output on board and “D” on 12-position terminal block.</li> </ul> <p><b>If no voltage is present:</b></p> <ul style="list-style-type: none"> <li>➤ Confirm that voltage is coming in from transformer.</li> <li>➤ Replace circuit board.</li> </ul> <p><b>If voltage is present:</b></p> <ul style="list-style-type: none"> <li>➤ Check motor relay for normal operation. (24 VAC 35Ω)</li> <li>➤ Check door switch for normal.</li> <li>➤ Check motor for normal operation. (See Technical Data for correct ratings)</li> </ul>

## NO HEAT

PROBABLE CAUSE	CORRECTIVE ACTION
<b>Defective Elements</b>	<ul style="list-style-type: none"> <li>➤ Check that elements are getting power.</li> <li>➤ Confirm that Elements are working correctly. (See Technical Data for correct ratings)</li> </ul>
<b>Defective Transformer</b>	<ul style="list-style-type: none"> <li>➤ Check transformer for normal operation.</li> <li>➤ Replace if necessary.</li> </ul>
<b>Defective Probe</b>	<ul style="list-style-type: none"> <li>➤ Confirm that probe has proper resistance for the correct temp. (See Technical Data for correct ratings)</li> </ul>
<b>Defective Heat Contactor</b>	<ul style="list-style-type: none"> <li>➤ Confirm that Contactor is getting correct voltage.</li> <li>➤ Confirm that Contactor is operating properly. (24VAC 6Ω)</li> </ul>

## TROUBLESHOOTING ECCO-SII CONT'D

PROBABLE CAUSE	CORRECTIVE ACTION
<b>Defective Circuit board</b>	<ul style="list-style-type: none"><li>➤ Confirm that Heat Call light is on.</li></ul> <p><b>If no light is detected:</b></p> <ul style="list-style-type: none"><li>➤ Check 12-position switch for normal operation. (See Technical Data for correct ratings)</li></ul> <p><b>If light is detected:</b></p> <ul style="list-style-type: none"><li>➤ Check for 24VAC across heat output and “D” on 12 Pole terminal.</li></ul> <p><b>If voltage is not present:</b></p> <ul style="list-style-type: none"><li>➤ Replace Circuit board.</li></ul> <p><b>If voltage is present:</b></p> <ul style="list-style-type: none"><li>➤ Check over temperature thermostat for proper operation.</li><li>➤ Check door switch for normal operation.</li></ul>

## TROUBLESHOOTING ECCO-C

- To help troubleshoot the oven you should perform the following “Manual Override” test:
- Open drop down door located on the lower right side, directly below front panel.
- Turn back up toggle (on/off) switch to “on” position.
- Turn main power switch to “on” position.
- Check oven for normal operation.

### NO DISPLAY

PROBABLE CAUSE	CORRECTIVE ACTION
Power switch is not turned on	<ul style="list-style-type: none"> <li>➤ Turn power switch on.</li> </ul>
Defective power switch Defective back-up relay	<ul style="list-style-type: none"> <li>➤ Check power switch for normal operation. Replace as necessary.</li> <li>➤ Check relay for normal operation.</li> <li>➤ Check coil for 24 VAC.</li> </ul> <p><b>If 24 VAC is measured.</b> Turn oven off and:</p> <ul style="list-style-type: none"> <li>➤ Check coil for 7.2 K<math>\Omega</math>.</li> <li>➤ Replace as necessary.</li> </ul> <p><b>If 24 VAC is not measured.</b></p> <ul style="list-style-type: none"> <li>➤ Verify that manual override switch is in “off” position.</li> <li>➤ Check manual override switch for normal operation.</li> <li>➤ Check wires for any shorts.</li> </ul>
Defective control transformer (12 VAC).	<ul style="list-style-type: none"> <li>➤ Check transformer for normal operation.</li> <li>➤ Check primary coil for 208/240 VAC and 630 <math>\Omega</math>. Check secondary coil for no less than 10.5 VAC and 1 <math>\Omega</math>.</li> </ul> <p><b>If voltage is not measured on primary:</b></p> <ul style="list-style-type: none"> <li>➤ Check wires for any shorts.</li> <li>➤ Check Power switch for normal operation.</li> </ul> <p><b>If voltage is measured on primary:</b></p> <ul style="list-style-type: none"> <li>➤ Check for voltage on secondary.</li> <li>➤ Replace transformer.</li> </ul>
Defective rectifier	<ul style="list-style-type: none"> <li>➤ Check for no less than 10.5 VAC on <b>TP1</b> and 5 VDC on <b>TP2</b>.</li> <li>➤ If correct voltage is present at <b>TP1</b> and present, but low at <b>TP2</b> unplug both ribbon connections from CPU and re-measure at <b>TP2</b>.</li> <li>➤ If voltage remains low at <b>TP2</b> replace CPU.</li> <li>➤ If voltage at <b>TP2</b> increased to 5 VDC when ribbon was unplugged, plug ribbon back in to CPU and disconnect from Interface board.</li> <li>➤ Re-measure at <b>TP2</b>.</li> <li>➤ If voltage dropped to below 5 VDC replace ribbon cable.</li> <li>➤ If voltage remains at 5 VDC, plug ribbon back into Interface board and measure for 5 VDC at <b>TP3</b>.</li> <li>➤ If voltage is present at <b>TP3</b> and display is still not on, press and hold the <b>R/C</b> button on board if LED’s come on replace Interface board.</li> <li>➤ If LED segment does not illuminate or the LED is blank, replace LED.</li> </ul>

At this point you should have a display.

## TROUBLESHOOTING ECCO-C CONT'D

### NO FAN-Manual Mode

PROBABLE CAUSE	CORRECTIVE ACTION
Defective 208-240/24 VAC transformer	<ul style="list-style-type: none"> <li>➤ Check for 24 VAC on “C” and “D” of the terminal block.</li> </ul> <p><b>If 24 VAC is not measured:</b> Turn off and:</p> <ul style="list-style-type: none"> <li>➤ Check secondary coil for 1 <math>\Omega</math>.</li> <li>➤ Check primary coil for 77 <math>\Omega</math>.</li> <li>➤ Replace transformer.</li> </ul> <p><b>If 24 VAC is measured:</b> Turn off and:</p> <ul style="list-style-type: none"> <li>➤ Check back-up relay for normal operation.</li> <li>➤ Check for 240 VAC on relay coil.</li> </ul>
Back-up relay not energizing	<p><b>If 240 VAC is measured:</b> Turn unit off and:</p> <ul style="list-style-type: none"> <li>➤ Check back-up relay coil for 7.2 K <math>\Omega</math>.</li> <li>➤ Replace if defective.</li> </ul> <p><b>If 240 VAC is not measured:</b></p> <ul style="list-style-type: none"> <li>➤ Check back-up switch (SPDT) for normal operation.</li> <li>➤ Replace if defective.</li> <li>➤ Check for 24 VAC at contactor or relay coil.</li> </ul>
Motor contactor not energized	<p><b>If 24 VAC is not measured:</b> Turn oven off and:</p> <ul style="list-style-type: none"> <li>➤ Check door switch for normal operation.</li> <li>➤ Replace or adjust door switch.</li> </ul> <p><b>If 24 VAC is measured:</b> Turn unit off and:</p> <ul style="list-style-type: none"> <li>➤ Check contactor coil for continuity.</li> <li>➤ Replace if defective.</li> </ul>
No voltage across contactor points	<ul style="list-style-type: none"> <li>➤ Check 208/240 VAC across “C” terminals of contactor.</li> </ul> <p><b>If 208/240 VAC is not measured:</b></p> <ul style="list-style-type: none"> <li>➤ Check connection to main contactor (heat contactor).</li> <li>➤ Check circuit breaker.</li> </ul> <p><b>If 208/240 VAC is measured:</b></p> <ul style="list-style-type: none"> <li>➤ Check across “NO” contacts. Should have 208/240 VAC.</li> <li>➤ Replace if defective.</li> </ul>

# TROUBLESHOOTING ECCO-C CONT'D

## NO MOTOR Computer Mode

PROBABLE CAUSE	CORRECTIVE ACTION
No 24 VAC on Interface board	<ul style="list-style-type: none"> <li>➤ Check for 24 VAC at <b>TP4</b> to common (“<b>D</b>”).</li> </ul> <p><b>If 24 VAC is not measured:</b></p> <ul style="list-style-type: none"> <li>➤ Check for 24 VAC at “<b>NC</b>” contacts on back-up relay.</li> </ul> <p><b>If 24 VAC is measured:</b></p> <ul style="list-style-type: none"> <li>➤ Check for 24 VAC at <b>TP5</b>.</li> <li>➤ Replace Interface board if defective.</li> </ul>

## NO HEAT Manual Mode

**NOTE:** Fan must be operating before trouble shooting No heat.

PROBABLE CAUSE	CORRECTIVE ACTION
Back-up relay not energizing	<ul style="list-style-type: none"> <li>➤ Check for 240 VAC on relay coil.</li> </ul> <p><b>If 240 VAC is measured.</b> Turn unit off and:</p> <ul style="list-style-type: none"> <li>➤ Check back-up relay coil for 7.2 <math>\Omega</math>.</li> <li>➤ Check “<b>NO</b>” contacts for 24 VAC.</li> <li>➤ Replace if defective.</li> </ul> <p><b>If 240 VAC is not measured:</b></p> <ul style="list-style-type: none"> <li>➤ Check back-up switch (SPDT) for normal operation.</li> <li>➤ Replace if defective.</li> </ul>
Defective thermostat	<ul style="list-style-type: none"> <li>➤ Turn unit off and check for continuity while cycling thermostat on and off.</li> <li>➤ Replace if defective.</li> </ul>
Defective contactor	<ul style="list-style-type: none"> <li>➤ Check for 24 VAC at heater coil.</li> </ul> <p><b>If 24 VAC is measured.</b> Turn oven off and:</p> <ul style="list-style-type: none"> <li>➤ Check for continuity through coil.</li> <li>➤ Replace if defective.</li> </ul> <p><b>If 24 VAC is not measured.</b> Turn oven off and:</p> <ul style="list-style-type: none"> <li>➤ Check for continuity through hi-temp wires going to over-temp thermostat.</li> <li>➤ Replace over-temp thermostat if defective.</li> </ul>
Defective elements	<ul style="list-style-type: none"> <li>➤ Check elements for continuity.</li> <li>➤ Replace if defective.</li> </ul>
Defective over-temp thermostat	<ul style="list-style-type: none"> <li>➤ Check for 24 VAC on #55 red wire to common “<b>D</b>”.</li> </ul> <p><b>If 24 VAC is not measured:</b> Turn oven off and:</p> <ul style="list-style-type: none"> <li>➤ Check for continuity through over-temp thermostat.</li> <li>➤ Replace if defective.</li> </ul>

# TROUBLESHOOTING ECCO-C CONT'D

## NO HEAT Computer Mode

PROBABLE CAUSE	CORRECTIVE ACTION
No 24 VAC on Interface board	<ul style="list-style-type: none"> <li>➤ Check for 24 VAC at <b>TP4</b> to ground.</li> </ul> <p><b>If 24 VAC is not measured:</b></p> <ul style="list-style-type: none"> <li>➤ Check for 24 VAC at “NC” contacts on back-up relay.</li> </ul> <p><b>If 24 VAC is measured:</b></p> <ul style="list-style-type: none"> <li>➤ Check for 24 VAC at <b>TP6</b>.</li> <li>➤ Replace Interface board if defective.</li> </ul>

## DISPLAY LOCKS UP

PROBABLE CAUSE	CORRECTIVE ACTION
“Help” in display	<ul style="list-style-type: none"> <li>➤ Check probe for proper resistance.</li> <li>➤ Check that probe connections are secure.</li> <li>➤ Push “TEMP” button on control board and check to see if temperature rapidly descends. If temp does descend rapidly, replace ribbon cable.</li> <li>➤ Check to see that contactors/relays are not stuck in the closed position.</li> <li>➤ Replace contactor if defective.</li> <li>➤ Check for foreign objects keeping contactor closed.</li> </ul>
“88888” stuck in display	<ul style="list-style-type: none"> <li>➤ Check for stuck button by pressing any button.</li> </ul> <p><b>If computer beeps or chirps:</b></p> <ul style="list-style-type: none"> <li>➤ Check control panel transformer (12 VAC) for proper operation.</li> <li>➤ Check <b>TP1</b> for at least 10.5 VAC.</li> <li>➤ Check <b>TP2</b> for at least 4.99 VDC.</li> <li>➤ Check <b>TP3</b> for at least 4.97 VDC.</li> </ul> <p><b>If computer does not beep or chirp:</b></p> <ul style="list-style-type: none"> <li>➤ Check each button for movement.</li> <li>➤ Check that panel label has not been damaged in any way.</li> <li>➤ Replace button if defective.</li> <li>➤ Replace panel label.</li> </ul>
Display has shelf “A”	<ul style="list-style-type: none"> <li>➤ Read Programming Codes.</li> </ul>

# TROUBLESHOOTING ECCO-PP, ECCO-PT

- To help troubleshoot the oven you should perform the following “Manual Override” test:
- Open drop down door located on the lower right side, directly below front panel.
- Turn back up toggle (on/off) switch to “on” position.
- Turn main power switch to “on” position.
- Check oven for normal operation.

## NO DISPLAY

PROBABLE CAUSE	CORRECTIVE ACTION
<b>Defective Power Switch (-PP only)</b>	<ul style="list-style-type: none"> <li>➤ Confirm that toggle switch is getting correct voltage.</li> <li>➤ Check power switch for normal operation.</li> </ul>
<b>Defective Power Switch output on circuit board (JP37)</b>	<ul style="list-style-type: none"> <li>➤ Confirm that JP37 has 5VDC in the off position and nominal voltage in the on position.</li> <li>➤ If JP37 has a constant 5VDC check toggle switch for normal operation.</li> </ul>
<b>Defective Control Transformer</b>	<ul style="list-style-type: none"> <li>➤ Confirm that 208/240VAC is feeding primary coil.</li> <li>➤ Confirm that 24VAC and 12VAC is at JP40 (24VAC across solid yellow wires and 12VAC from one solid yellow wire to yellow with red stripe).</li> </ul>
<b>Defective Display</b>	<ul style="list-style-type: none"> <li>➤ Check ribbon cable connections.</li> <li>➤ Confirm that voltage is present at JP40.</li> </ul> <p><b>If no voltage is present:</b></p> <ul style="list-style-type: none"> <li>➤ Replace control transformer.</li> </ul> <p><b>If voltage is present:</b></p> <ul style="list-style-type: none"> <li>➤ Confirm that CPU has 5VDC at TP1 (this means that the CPU is getting correct voltage).</li> <li>➤ Confirm that CPU has 12VDC at TP2 (this means that the CPU is sending out the correct voltage).</li> </ul> <p><b>If no voltage is present:</b></p> <ul style="list-style-type: none"> <li>➤ Replace CPU.</li> </ul> <p><b>If voltage is present:</b></p> <ul style="list-style-type: none"> <li>➤ Replace display.</li> </ul>

**IMPORTANT NOTICE:** Power must be disconnected at source when disconnecting any ribbon cable or any connector from CPU or Display. Failure to do so will result in damage to the Display board and CPU.

# TROUBLESHOOTING ECCO-PP, ECCO-PT CONT'D

## NO MOTOR, MANUAL MODE

PROBABLE CAUSE	CORRECTIVE ACTION
<p><b>Defective back-up toggle switch</b></p> <p><b>Defective back-up relay</b></p> <p><b>Defective component transformer</b></p> <p><b>Defective motor relay</b></p> <p><b>Defective motor</b></p>	<ul style="list-style-type: none"> <li>➤ Confirm that toggle switch is in the “ON” position.</li> <li>➤ Check toggle switch for normal operation.</li> <li>➤ Check for 208/240VAC at relay coil.</li> </ul> <p><b>If no voltage is present:</b></p> <ul style="list-style-type: none"> <li>➤ Confirm that points are making.</li> </ul> <p><b>If voltage is present:</b></p> <ul style="list-style-type: none"> <li>➤ Replace relay.</li> <li>➤ Confirm that 208/240VAC is feeding primary coil.</li> <li>➤ Confirm that 24VAC is at secondary coil.</li> </ul> <p><b>Defective motor relay</b></p> <ul style="list-style-type: none"> <li>➤ Check for 24VAC at relay coil.</li> </ul> <p><b>If no voltage is present:</b></p> <ul style="list-style-type: none"> <li>➤ Confirm that points are making.</li> </ul> <p><b>If voltage is present:</b></p> <ul style="list-style-type: none"> <li>➤ Replace relay.</li> <li>➤ Check for 208/240VAC across P1 and T7/T4.</li> </ul> <p><b>Defective motor</b></p> <p><b>If no voltage is present:</b></p> <ul style="list-style-type: none"> <li>➤ Confirm that wires have continuity.</li> </ul> <p><b>If voltage is present:</b></p> <ul style="list-style-type: none"> <li>➤ Replace motor.</li> </ul>

## NO MOTOR, COMPUTER MODE

**IMPORTANT NOTICE:** Before trying to trouble shoot “No Motor in Computer Mode” confirm that motor is operational in “Manual Mode”.

PROBABLE CAUSE	CORRECTIVE ACTION
<p><b>Defective output on CPU board</b></p>	<ul style="list-style-type: none"> <li>➤ Check for 24VAC at JP12 for high or JP13 for low (while oven is calling for heat).</li> </ul> <p><b>If no voltage is present:</b></p> <ul style="list-style-type: none"> <li>➤ Board is operating correctly.</li> </ul> <p><b>If voltage is present:</b></p> <ul style="list-style-type: none"> <li>➤ Replace CPU.</li> </ul>

# TROUBLESHOOTING ECCO-PP, ECCO-PT CONT'D

## NO HEAT, MANUAL MODE

PROBABLE CAUSE	CORRECTIVE ACTION
<b>Defective back-up toggle switch</b>	<ul style="list-style-type: none"> <li>➤ Confirm that toggle switch is in the “ON” position.</li> <li>➤ Check toggle switch for normal operation.</li> </ul>
<b>Defective back-up relay</b>	<ul style="list-style-type: none"> <li>➤ Check for 208/240VAC at relay coil.</li> </ul> <p><b>If no voltage is present:</b></p> <ul style="list-style-type: none"> <li>➤ Confirm that points are making.</li> </ul> <p><b>If voltage is present:</b></p> <ul style="list-style-type: none"> <li>➤ Replace relay.</li> </ul>
<b>Defective component transformer</b>	<ul style="list-style-type: none"> <li>➤ Confirm that 208/240VAC is feeding primary coil.</li> <li>➤ Confirm that 24VAC is at secondary coil.</li> </ul>
<b>Defective Thermostat</b>	<ul style="list-style-type: none"> <li>➤ Confirm that thermostat has 24VAC.</li> </ul> <p><b>If no voltage is present</b></p> <ul style="list-style-type: none"> <li>➤ Check component transformer and wiring for normal operation.</li> </ul> <p><b>If voltage is present</b></p> <ul style="list-style-type: none"> <li>➤ Check thermostat for normal operation. Replace as necessary.</li> </ul>
<b>Defective heat contactor</b>	<ul style="list-style-type: none"> <li>➤ Check for 24VAC at relay coil.</li> </ul> <p><b>If no voltage is present:</b></p> <ul style="list-style-type: none"> <li>➤ Confirm that points are making.</li> </ul> <p><b>If voltage is present:</b></p> <ul style="list-style-type: none"> <li>➤ Replace contactor.</li> </ul>
<b>Defective elements</b>	<ul style="list-style-type: none"> <li>➤ Check for 208/240VAC across elements.</li> </ul> <p><b>If no voltage is present:</b></p> <ul style="list-style-type: none"> <li>➤ Confirm that wires have continuity.</li> </ul> <p><b>If voltage is present:</b></p> <ul style="list-style-type: none"> <li>➤ Replace elements.</li> </ul>

# TROUBLESHOOTING ECCO-PP, ECCO-PT CONT'D

## NO HEAT, COMPUTER MODE

**IMPORTANT NOTICE:** Before trying to trouble shoot “No Heat in Computer Mode” confirm that the oven heats in “Manual Mode”.

PROBABLE CAUSE	CORRECTIVE ACTION
<b>Defective output on CPU board</b>	<ul style="list-style-type: none"> <li>➤ Check for 24VAC at JP11 (while oven is calling for heat).</li> </ul> <p><b>If no voltage is present:</b></p> <ul style="list-style-type: none"> <li>➤ Board is operating correctly.</li> </ul> <p><b>If voltage is present:</b></p> <ul style="list-style-type: none"> <li>➤ Replace CPU.</li> </ul>

## ANOMALIES

PROBABLE CAUSE	CORRECTIVE ACTION
<b>Display will intermittently blank out</b>  <b>Intermittently over heats or under cooks</b>	<ul style="list-style-type: none"> <li>➤ Check ribbon cable for good connections</li> <li>➤ Check panel label buttons and confirm that none of the domes are collapsed.</li> </ul> <p><b>If domes are collapsed:</b></p> <ul style="list-style-type: none"> <li>➤ Replace panel label.</li> </ul> <ul style="list-style-type: none"> <li>➤ Check probe for proper resistance.</li> <li>➤ Check ribbon connection for good connection.</li> <li>➤ Check probe for good connection.</li> </ul>

## **ELEMENT RESISTANCE**

➤ 208 Volt	16 Ω
➤ 480 Volt	60 Ω

## **TRANSFORMER RESISTANCE**

TRANSFORMER	Input	Primary		Secondary		Output
➤ 208/24 Volt	208/240 Volt	77 Ω		1Ω		24 Volt
➤ 240/12 Volt	208/240 Volt	630 Ω		1 Ω		12 Volt
➤ 208/240-24/12	208/240 Volt	208Volts 64 Ω	240Volts 75 Ω	12Volts .6 Ω	24Volts 1 Ω	24/12 Volts

## **CONTACTOR RESISTANCE**

CONTACTOR	Coil
➤ 3 Pole 24 Volt coil	6 Ω
➤ 2 Pole 24 Volt coil (P & B) (PP & PT motor)	35 Ω

## **RELAY RESISTANCE**

RELAY	Coil
➤ 240 VAC	7.2 KΩ

## **OVER-TEMP THERMOSTAT**

OVER-TEMP	
➤ Wires	Normally closed

## **DOOR SWITCH**

- Check switch between “COM” (common) and “NO” (normally open) contacts, insure switch closes approximately 3 to 4 inches before door closes.

## **BLOWER FAN**

- Blower fan will rotate clockwise and should have a 5/8“ gap between it and the back wall of the can.

## AUTO/BYPASS SWITCH

The Auto / Bypass and Energy switch are located below the controls behind a pull down access panel.

- Auto/Bypass switch Normally in **“OFF”**. The **“ON”** position will interrupt power to the computer and allow use of the back-up thermostat.
  
- Energy switch Normally in **“HIGH”** for 11 kW heats. **“LOW”** WILL PROVIDE 8.25 kW heat. Not provided on Steam convection ovens.

## LINE AMPERAGE, WATTAGE, AND PROPER PHASING

MODEL NUMBER	TOTAL K.W. CONNECTION	NORMAL AMPS PER LINE									SINGLE PHASE	
		THREE PHASE									208 V	240V
		208 VOLT			240 VOLT			480 VOLT				
		L1	L2	L3	L1	L2	L3	L1	L2	L3		
ECCO	11.66	37.0	37.0	22.9	28.9	28.9	26.5	16.5	16.5	10.2	56.0	48.6
2ECCO	23.33	60.0	74.2	60.0	55.3	57.7	55.3	26.0	33.0	26.0	112.0	97.2

SERVICE CONNECTIONS					
FRONT WIRE CONNECTIONS					
	3 PHASE			1 PHASE	
	LINE 1	LINE 2	LINE 3	LINE 1	LINE 2
<b>1<sup>st</sup> OVEN</b>	1,4	2	3	1,3	2,4
<b>2<sup>nd</sup> OVEN</b>	1,4,7	2,5,8	3,6	1,3,5,7	2,4,6,8
REAR CONNECTION WIRE NUMBERS					
<b>1<sup>st</sup> OVEN</b>	5,8	6	7	5,7	6,8
<b>2<sup>nd</sup> OVEN</b>	7	5,8	6	5,7,5,7	6,8,6,8

## ECCO-PT / PP COOKING CURVE CONVERSION

Old Style Purple	New Style Platinum / Purple Plus
0	0%
1	17%
2	26%
3	40%
4	50%
5	56%
6	63%
7	71%

## PROBE RESISTANCE

TEMP	RESISTANCE	VOLT DROP	TEMP	RESISTANCE	VOLT DROP
70°	556 Ω	1.11	290°	881 Ω	1.76
80°	569 Ω	1.14	300°	897 Ω	1.79
90°	583 Ω	1.17	310°	914 Ω	1.83
100°	596 Ω	1.19	320°	931 Ω	1.86
110°	610 Ω	1.22	330°	948 Ω	1.90
120°	623 Ω	1.25	340°	965 Ω	1.93
130°	637 Ω	1.27	350°	983 Ω	1.97
140°	651 Ω	1.3	360°	1000 Ω	2.00
150°	665 Ω	1.33	370°	1018 Ω	2.04
160°	678 Ω	1.36	380°	1036 Ω	2.07
170°	694 Ω	1.39	390°	1054 Ω	2.11
180°	709 Ω	1.42	400°	1072 Ω	2.14
190°	724 Ω	1.45	410°	1090 Ω	2.18
200°	739 Ω	1.48	420°	1109 Ω	2.22
210°	754 Ω	1.51	430°	1127 Ω	2.25
220°	769 Ω	1.54	440°	1146 Ω	2.29
230°	785 Ω	1.57	450°	1165 Ω	2.33
240°	800 Ω	1.60	460°	1184 Ω	2.37
250°	816 Ω	1.63	470°	1204 Ω	2.41
260°	832 Ω	1.66	480°	1223 Ω	2.45
270°	848 Ω	1.70	490°	1243 Ω	2.49
280°	864 Ω	1.73	500°	1263 Ω	2.53

### NOTE

Probe is factory checked at 350 °F. Must be completely disconnected from circuit board when measuring probe resistance. Display will read "HELP" if probe is open or unplugged. Any probe resistance can be multiplied by 2 milli-amps (.002) to determine voltage drop.

## ECCO-C MODEL STRAPPING

The Front Control panel of the Lang "Purple" computer must be configured to match the model of oven it is being installed in. To configure the front control panel, you must change the arrangement of the **Strapping Bars** located at the bottom of the circuit board just above the ribbon connection. Each model has its own strapping configuration, which must be set by the service technician. Follow the diagram below for the proper strapping configuration.

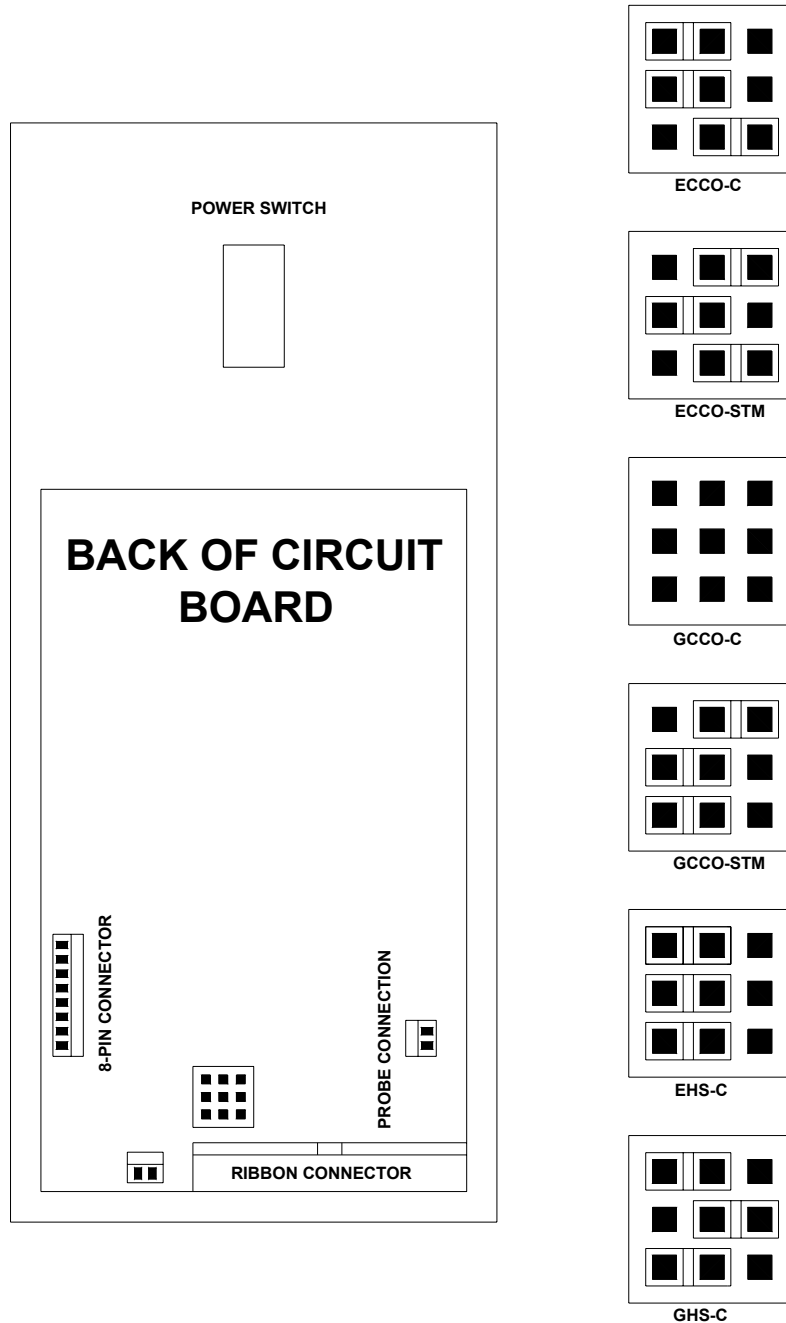

## ECCO-C TEST POINT LAYOUT

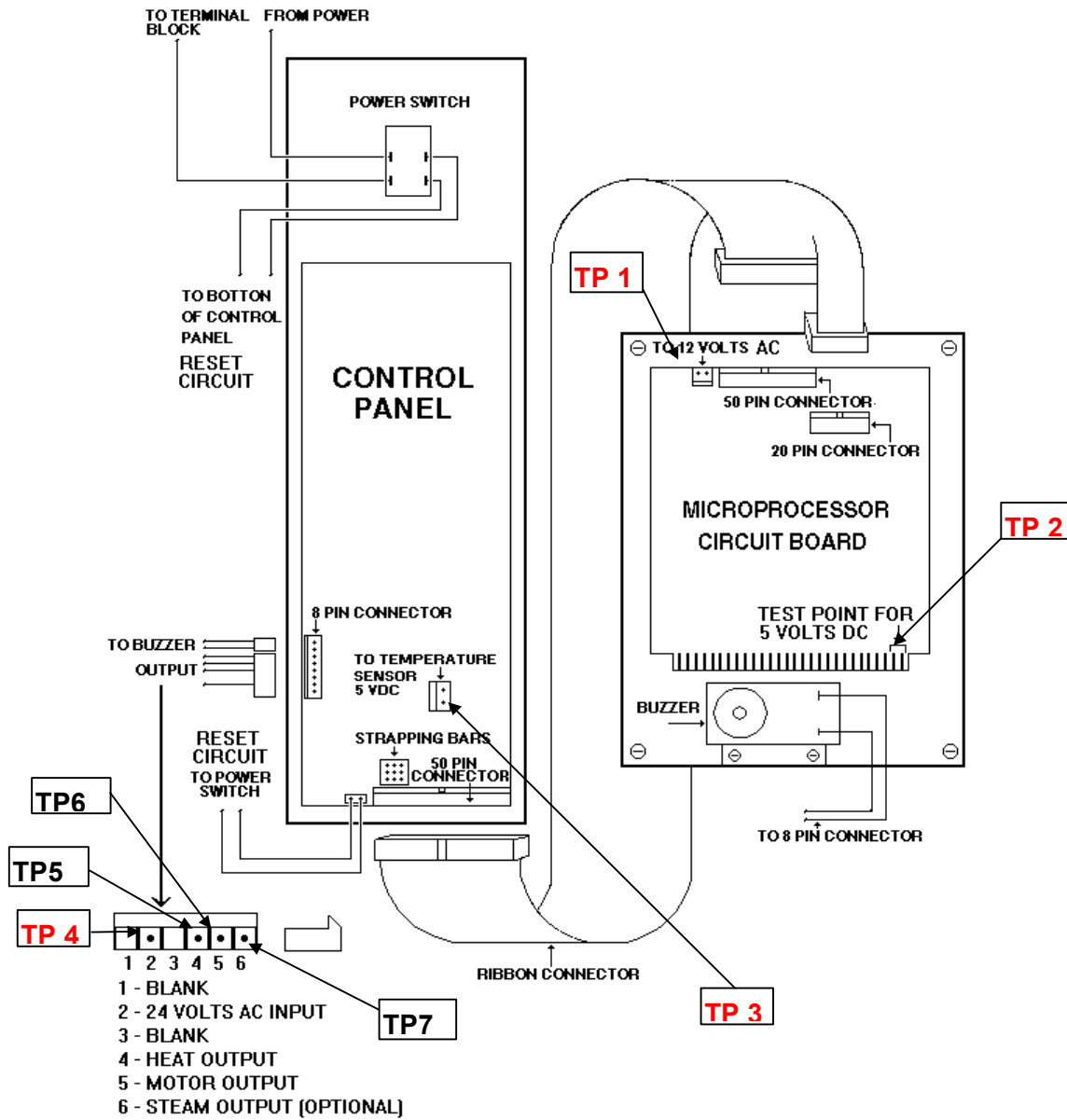

## ECCO-PP / PT TEST POINT LAYOUT

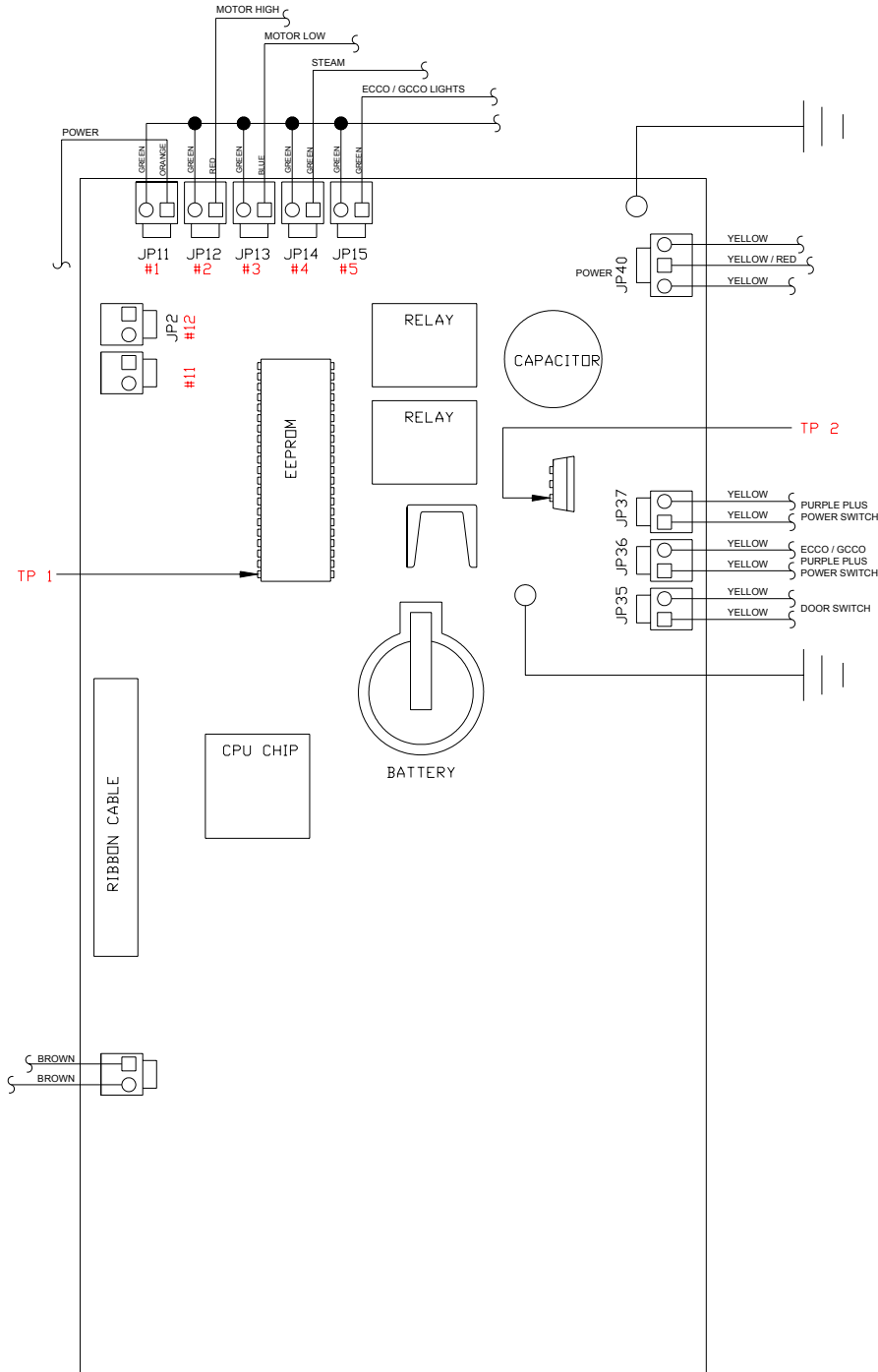

# WIRING DIAGRAM ECCO-T 208/240

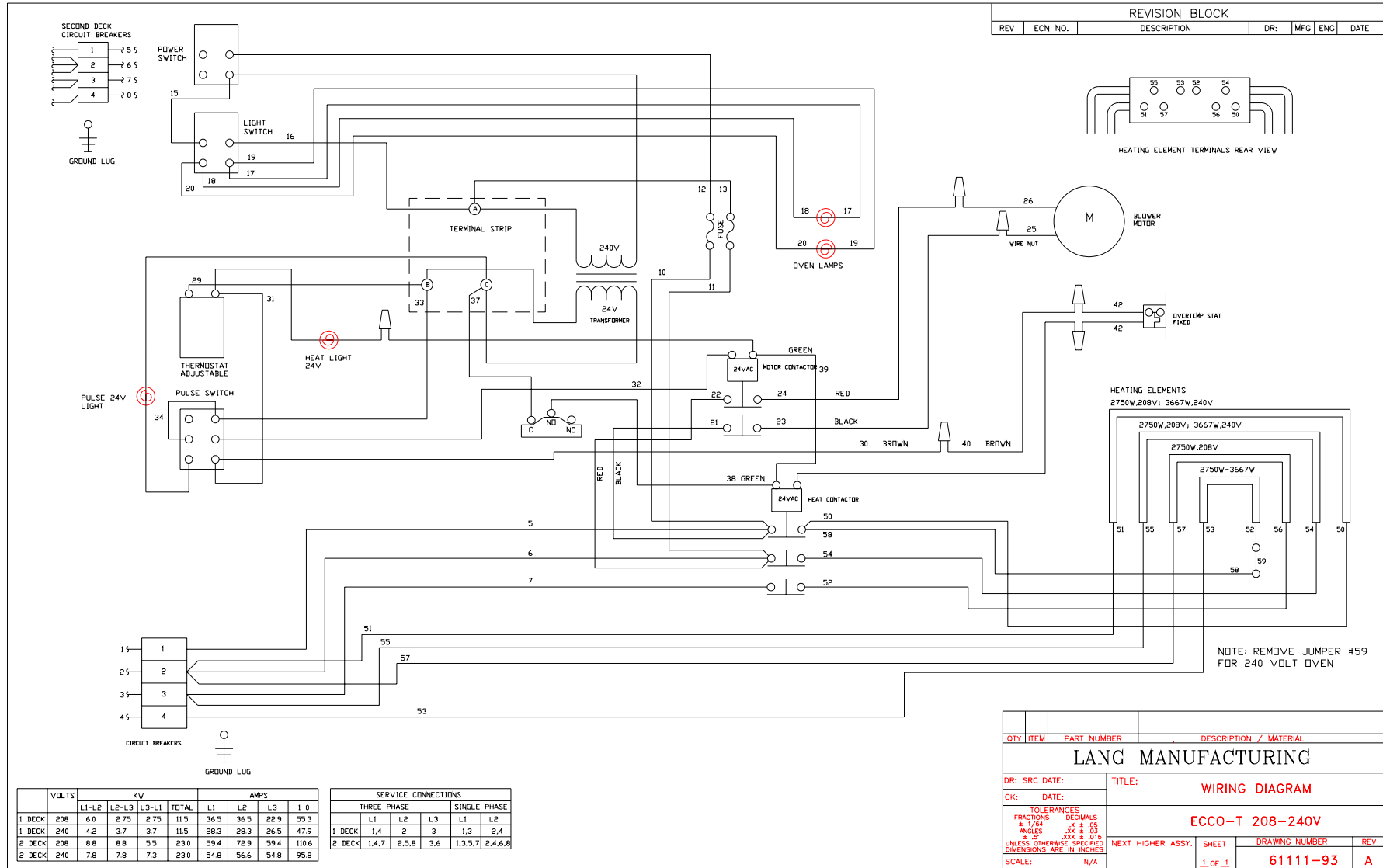



# WIRING DIAGRAM ECCO-AP 208/240

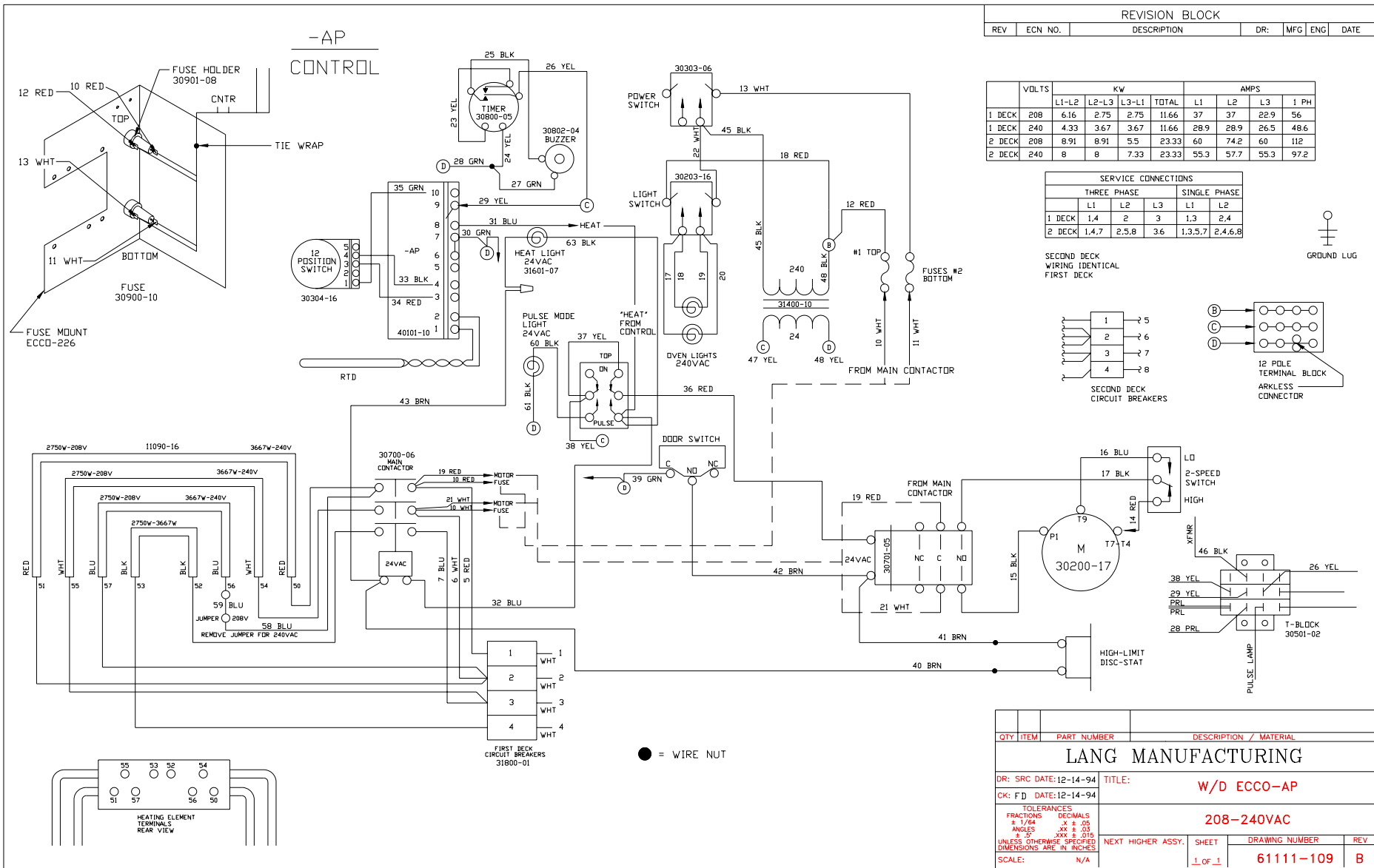

# WIRING DIAGRAM ECCO-AP 480

REVISION BLOCK

REV	ECN NO.	DESCRIPTION	DR:	MFG	ENG	DATE
C		ADDED NEW TERMINAL BLOCK	SRC			1-23-98

	VOLTS	KW			AMPS			
		L1-L2	L2-L3	L3-L1	TOTAL	L1	L2	L3
1 DECK	480	6.0	2.7	2.7	11.5	15.8	15.8	10.0
2 DECK	480	8.7	8.7	5.4	23.0	25.8	31.6	25.8

SERVICE CONNECTIONS			
	L1	L2	L3
1 DECK	1	2	3
2 DECK	1-6	2-4	3-5

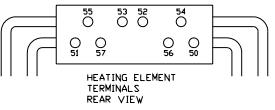
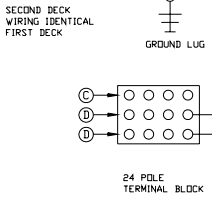
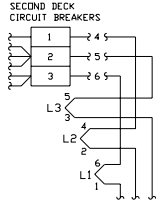
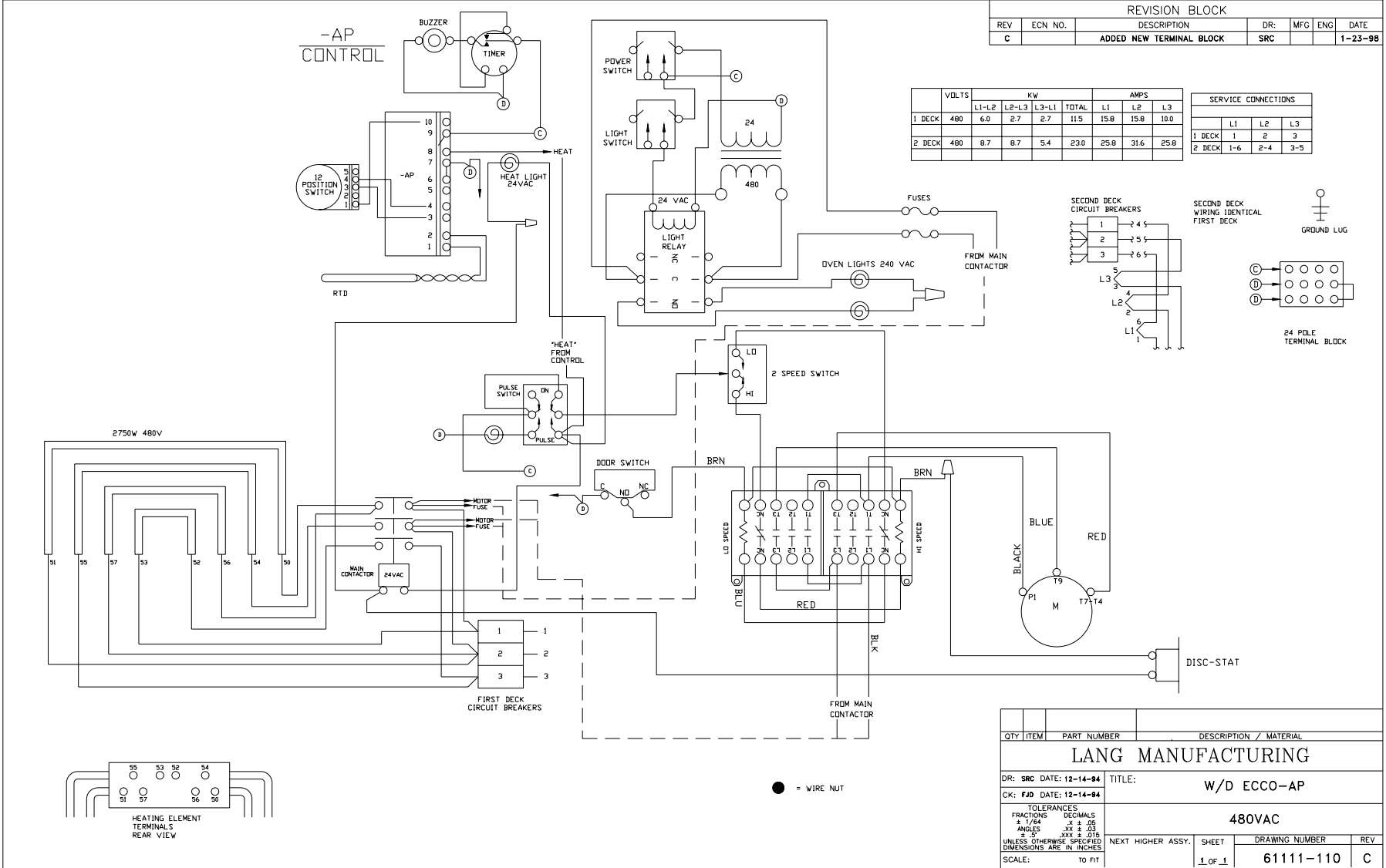

QTY	ITEM	PART NUMBER	DESCRIPTION / MATERIAL
<b>LANG MANUFACTURING</b>			
DR: SRC DATE: 12-14-94		TITLE: W/D ECCO-AP	
CK: FJD DATE: 12-14-94			
<b>480VAC</b>			
TOLERANCES			
FRACTIONS	DECIMALS		
± 1/64	× ± .05		
ANGLES	xx ± .03		
± .25	xxx ± .015		
UNLESS OTHERWISE SPECIFIED DIMENSIONS ARE IN INCHES			
SCALE:	TO FIT	NEXT HIGHER ASSY.	SHEET
		1 OF 1	DRAWING NUMBER
			61111-110
			REV
			C

# WIRING DIAGRAM ECCO-SII 208/240

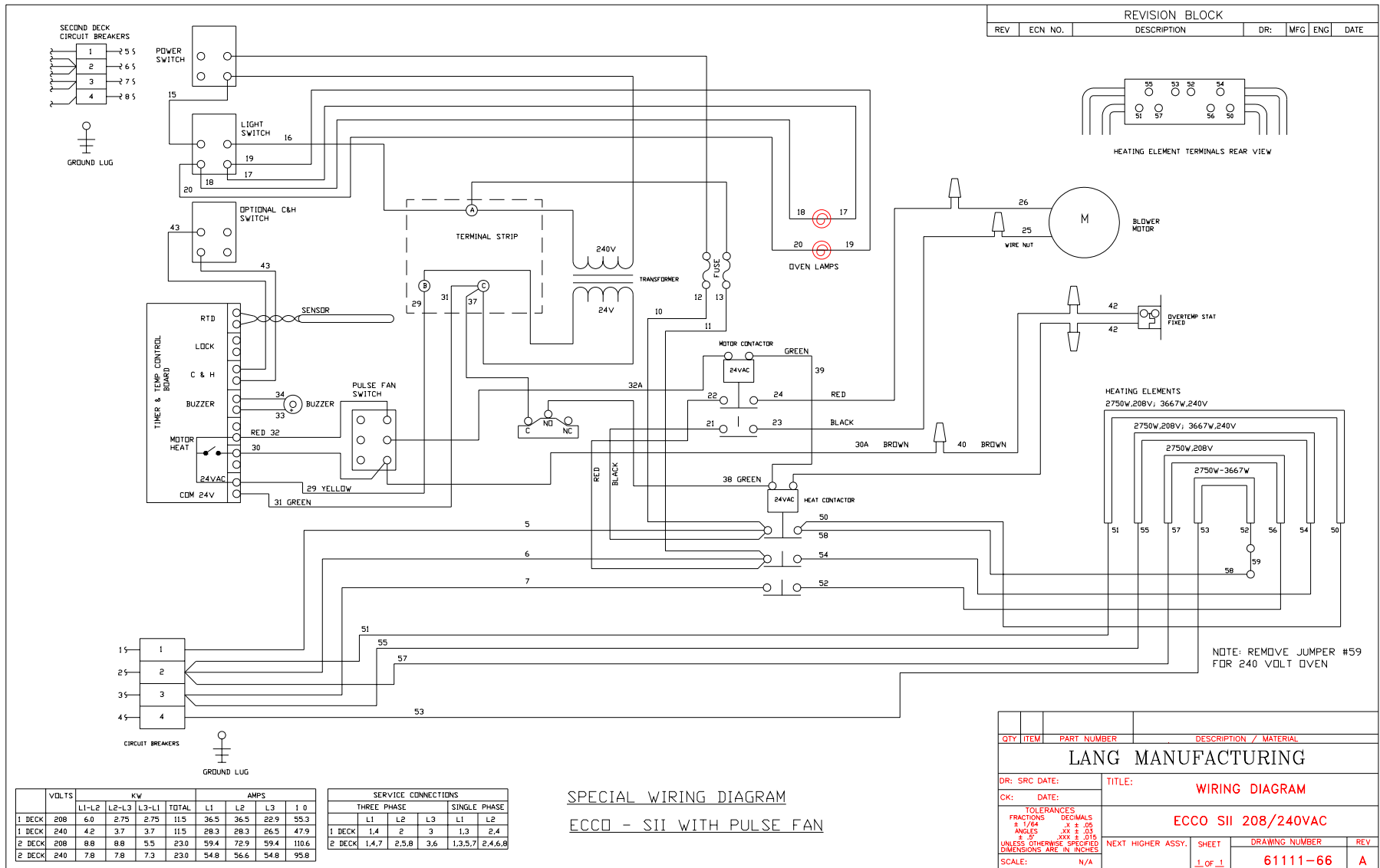



# WIRING DIAGRAM ECCO-C 208/240

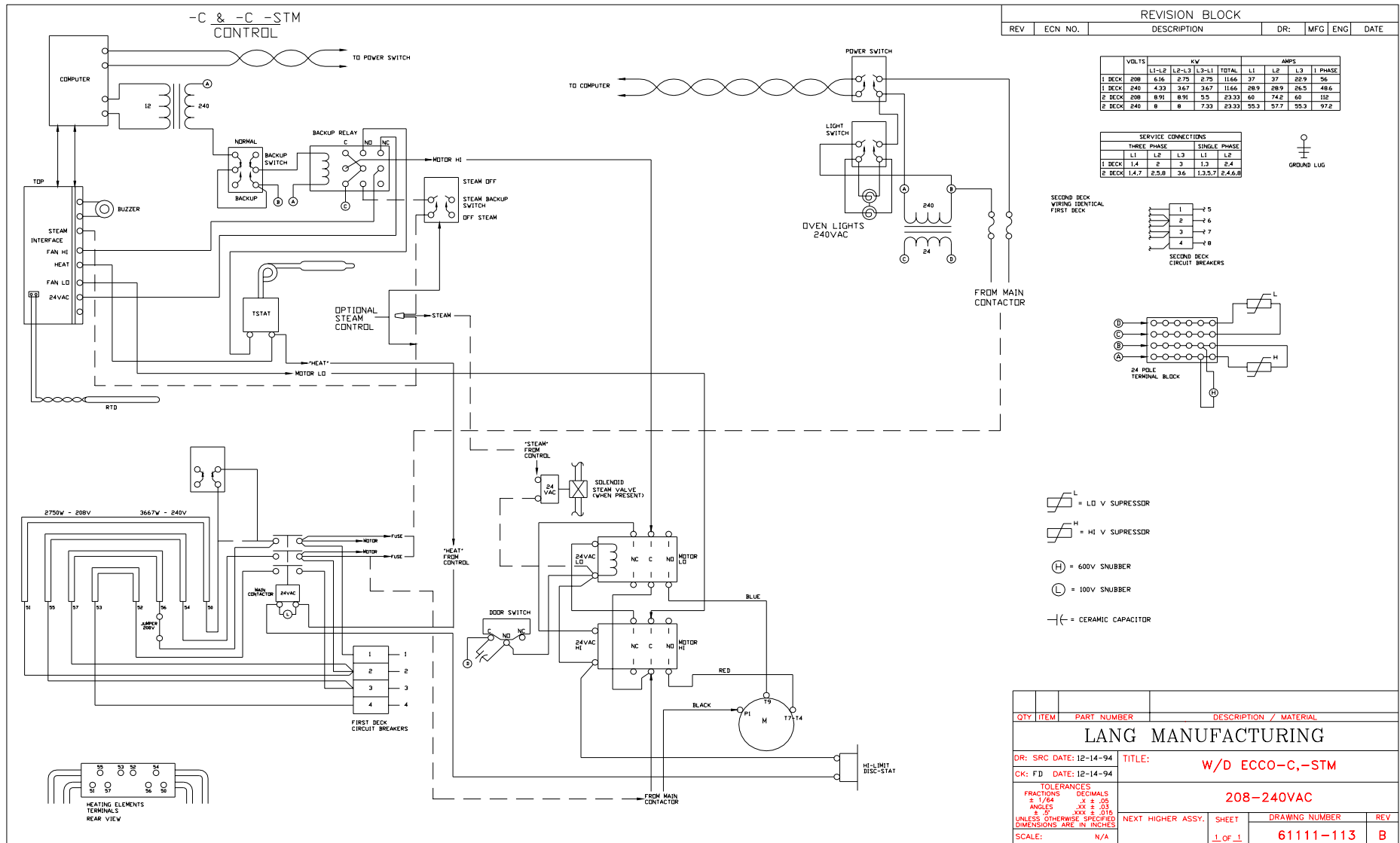

# WIRING DIAGRAM ECCO-C 480

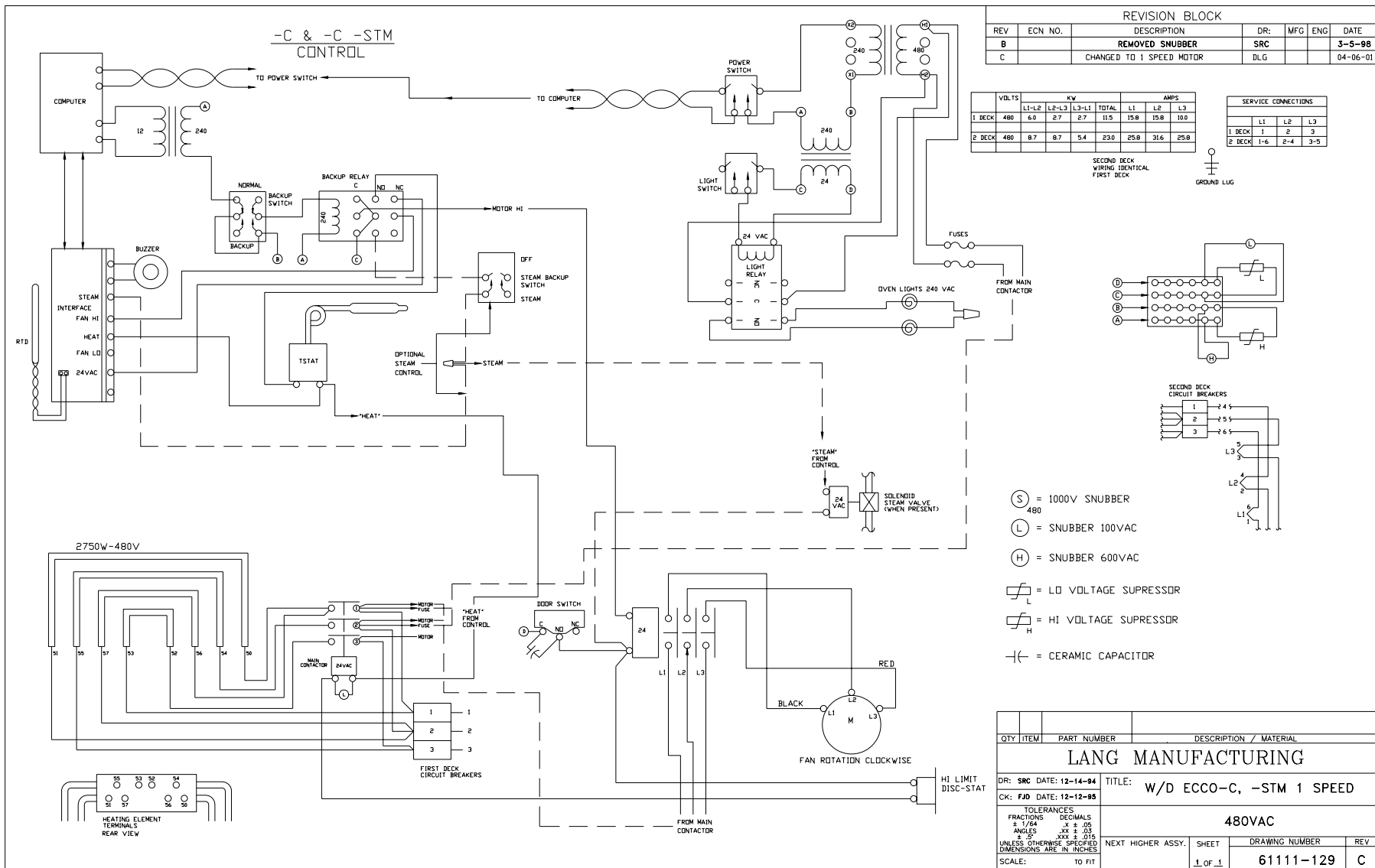

# WIRING DIAGRAM ECCO-PP 208/240

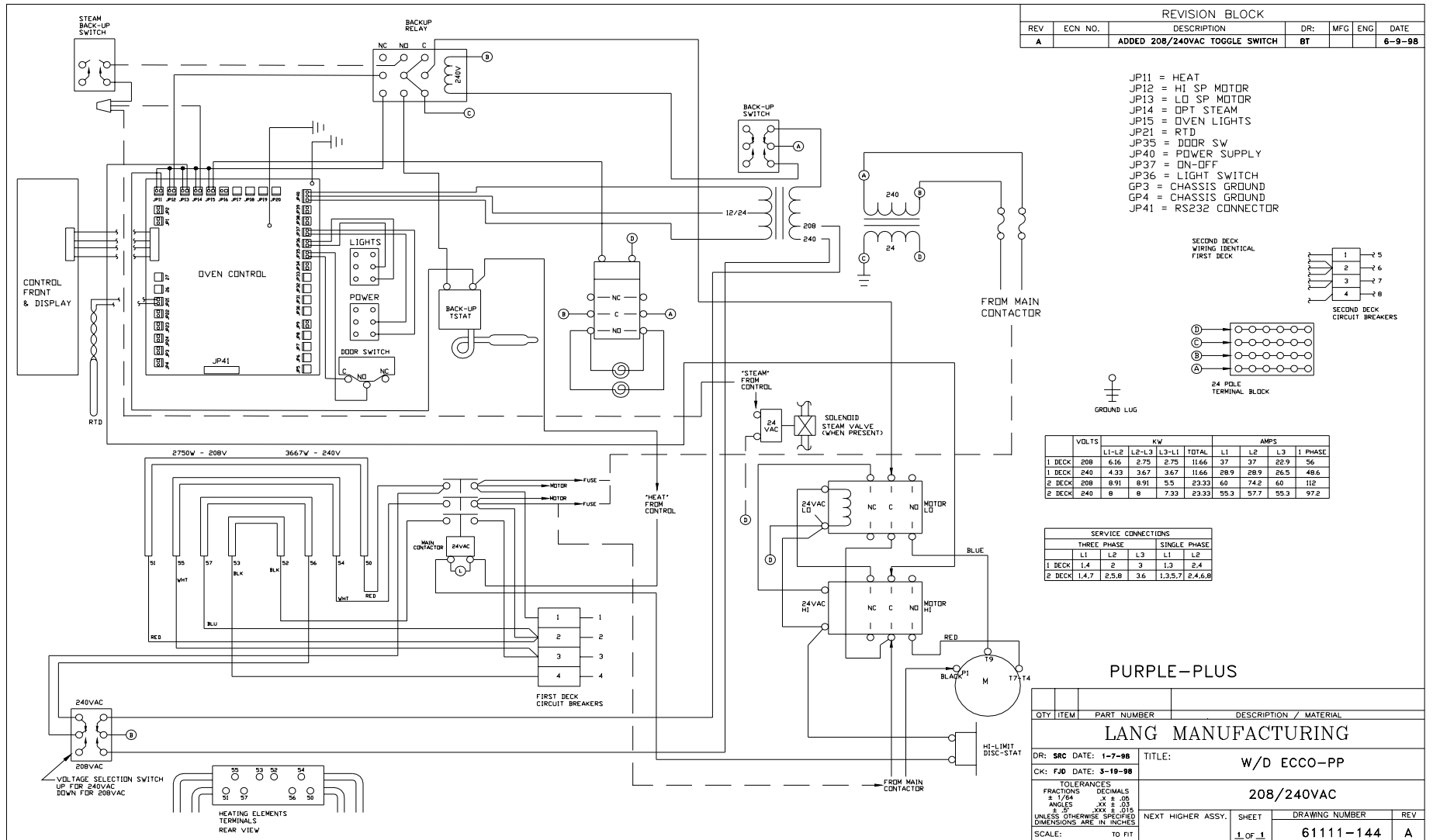

# WIRING DIAGRAM ECCO-PP 480

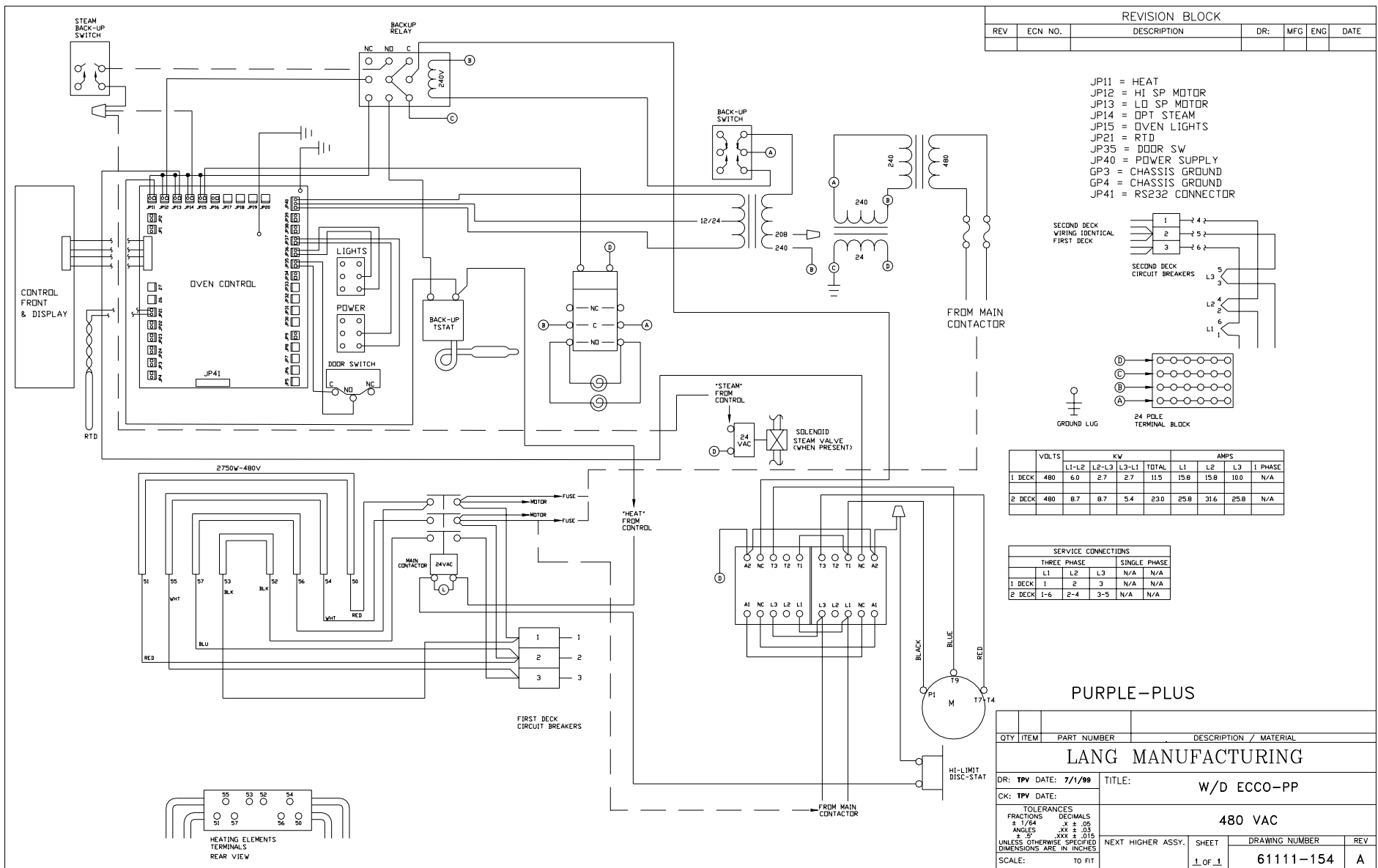

# WIRING DIAGRAM ECCO-PT 208/240

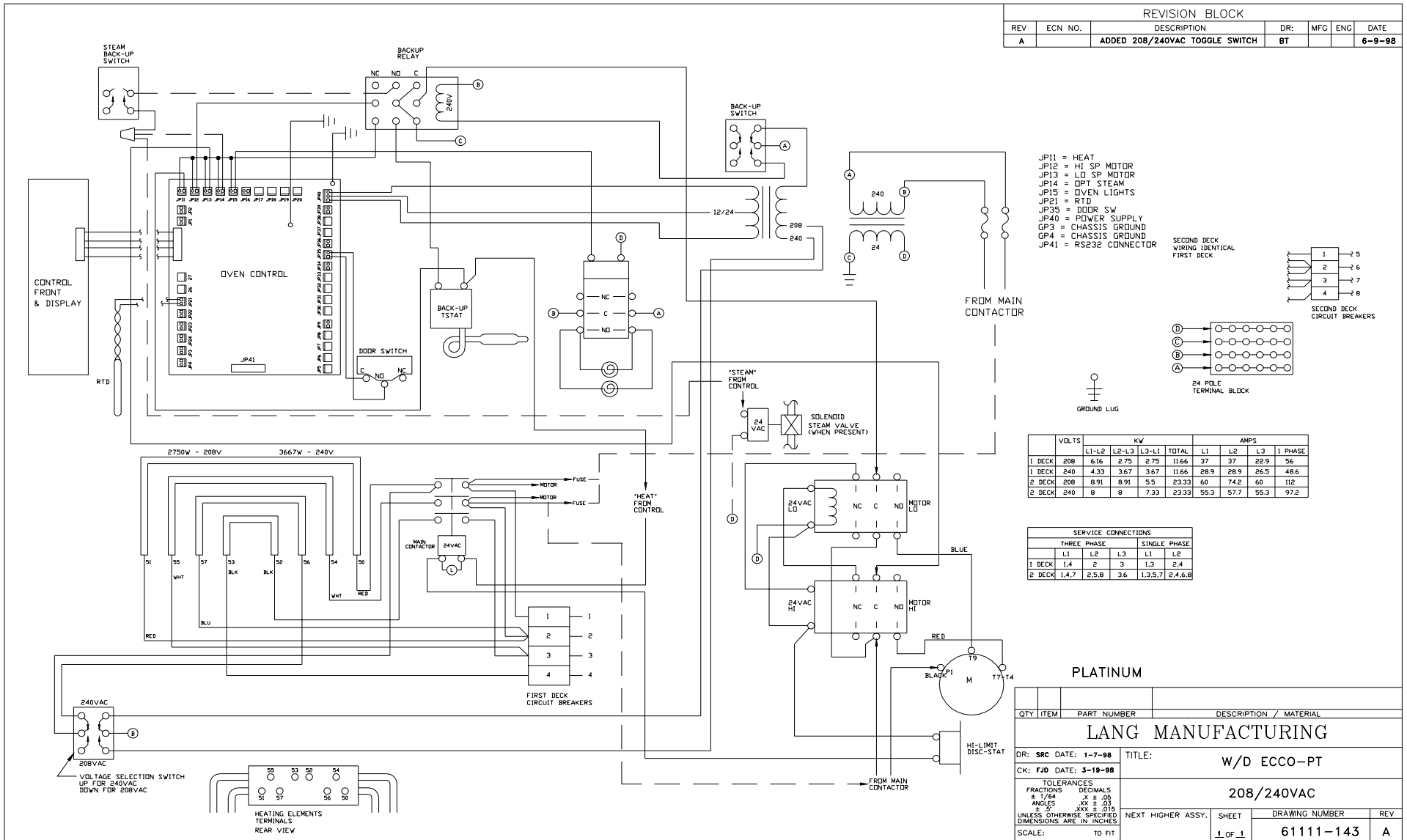

# WIRING DIAGRAM ECCO-PT 480

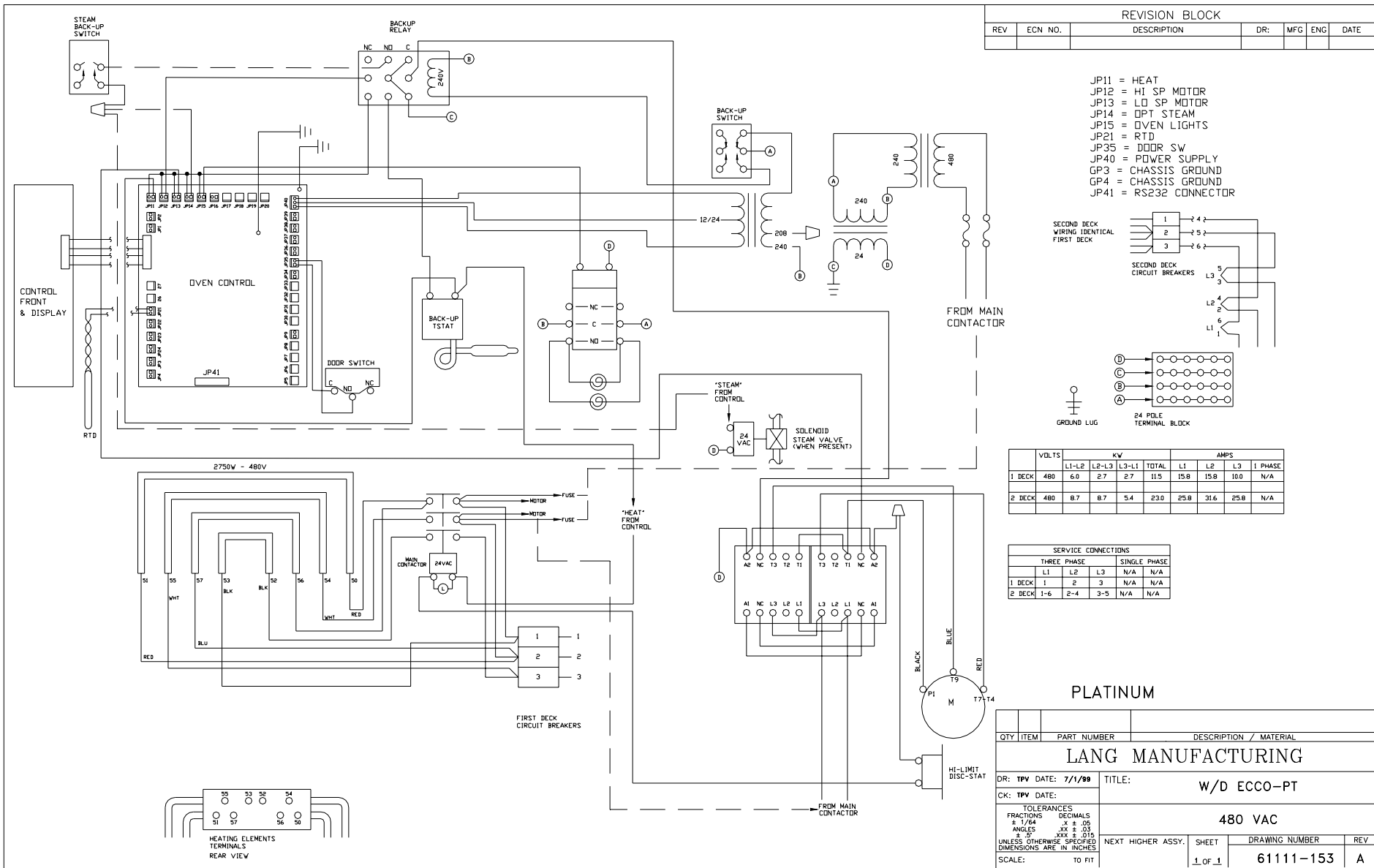

## PARTS LIST ECCO-T

DESCRIPTION	PART NO.
Element ECCO Oven 208/240 Volt 11000 Watts	11090-16
Element ECCO Oven 480 Volt 11000 Watts	11090-18
Element ECCO Oven 380 Volt 11000 Watts	11090-30
Motor 1/3 HP 480 Volt (Before F-90435)	30200-03
Motor 1/3 HP 115/208/240 Volt (Before F-90435)	30200-12
Motor 1/3 HP 480 Volt 2 Speed (After H-90436)	30200-16
Motor 1/3 HP 208/240 Volt 2 Speed (After H-90436)	30200-17
Switch Micro Convection Oven Door	30301-02
Switch Toggle On-Off	30303-06
Switch Toggle Spring Return	30303-16
Thermostat Safety 490°F Open	30401-09
Thermostat 450°F Oven	30402-27
Terminal Strip 3-Pole	30501-02
Contactor 3 Pole 24 VAC	30700-06
Contactor 2 Pole 24 VAC	30701-04
Contactor 2 Pole 30 Amp 24 VAC	30701-05
Contactor 2 Speed Motor 24 VAC (480 VAC only)	30705-03
Timer Electric 1 Hour 24V (After H-90436)	30800-05
Timer Mechanical Long Ring (Before F-90435)	30801-01
Buzzer Electric Timer 24V (After H-90436)	30802-04
Fuse 15 AMP 300 Volt	30900-10
Fuse Holder 15 Amp	30901-08
Transformer 120-208-240/24 VAC	31400-07
Transformer 480/24 VAC	31400-15
Transformer 380/24 VAC	31400-18
Pilot Light 28 VAC	31601-07
Lamp Socket	31602-04
Lamp Incandescent 250 Volt Clear	31603-04
Oven Lamp Lens (Watch Glass)	31604-01
Oven Lamp Lens Gasket	31604-02
Circuit Breaker 208/240 Volt 1-Pole	31800-01
Circuit Breaker 480 Volt 3-Pole	31800-04
Rack	50200-20
Rack Slide (Before H-36961)	50200-36
Rack Slide (After H-36961)	50200-93
Rack Extra Deep	50200-31
Rack Slide Extra Deep (Before _-38832)	50200-33
Rack Slide Extra Deep (After _-38832)	50200-94
Turnbuckle Assembly	50312-02
Door Left Hand	51100-45
Door Right Hand	51100-46
Panel Label (Before F-90435)	60301-91
Panel Label (After H-90436)	60301-101
Handle Assembly, Single Handle Oven	70603-15
Knob Damper Black	70701-25
Knob Time Control (Before F-90435)	70701-27
Knob Temperature/Time Control	70701-28
Window Assembly, Oven Door	71301-04
Blower Wheel	71500-05

## PARTS LIST ECCO-AP

DESCRIPTION	PART NO.
Element ECCO Oven 208/240 Volt 11000 Watts	11090-16
Element ECCO Oven 480 Volt 11000	11090-18
Motor 1/3 HP 480 Volt 2 Speed	30200-16
Motor 1/3 HP 208/240 Volt 2 Speed	30200-17
Micro Switch, Oven Door	30301-02
Switch, Toggle, On-On	30303-06
Switch, Toggle, Spring Return	30303-16
Switch, Temperature Control 12 Position 140-450°F	30304-16
Thermostat Safety 490°F Open	30401-09
Contactor 3 Pole 24 VAC	30700-06
Contactor 2 Pole 30 Amp 24 VAC	30701-05
Contactor 2 Speed Motor 24 VAC (480V Only, before H-90435)	30705-02
Contactor 2 Speed Motor 24 VAC (480V Only, After H-90436)	30705-03
Timer Electric 1 Hour 24V	30800-05
Buzzer Electric Timer 24V	30802-04
Fuse 15 Amp 300 Volt	30900-10
Fuse Holder 15 Amp	30901-08
Transformer 120-208-240/24 VAC	31400-07
Transformer 480/24 VAC	31400-15
Pilot Light 28 VAC	31601-07
Lamp Socket	31602-04
Lamp 250 Volt	31603-04
Oven Lamp Lens (Watch Glass)	31604-01
Oven Lamp Lens Gasket	31604-02
Circuit Breaker 208/240 Volt 1-Pole	31800-01
Circuit Breaker 480 Volt 3 Pole	31800-04
Circuit Board Temperature Control	40101-19
Probe Temperature Sensor	41100-08
Turn Buckle Assembly	50312-02
Door Left Hand	51100-45
Door Right Hand	51100-46
Panel Label Accu-Plus	60301-100
Handle Assembly Single-handle Oven	70603-15
Knob Damper Black	70701-25
Knob Temperature / Timer Control	70701-28
Window Assembly	71301-04
Blower Wheel	71500-05
Rack	50200-20
Rack Slide (Before B-36357)	50200-36
Rack Slide (After B-36357)	50200-93
Extra Deep Rack	50200-31
Extra Deep Rack Slide (Before _-38832)	50200-33
Extra Deep Rack Slide (After _-38832)	50200-94

## PARTS LIST ECCO-SII

DESCRIPTION	PART NO.
Element ECCO Oven 208/240 Volt 11000 Watts	11090-16
Element ECCO Oven 480 Volt 11000 Watts	11090-18
Motor 1/3 HP 480 Volt (Before F-79818 no pulse fan, Before H-90435 with pulse fan)	30200-03
Motor 1/3 HP 115/208/240 Volt (Before F-79818 no pulse fan, Before H-90435 with pulse fan)	30200-12
Motor 1/3 HP 480 Volt 2 Speed (After F-79819 no pulse fan, After H-90436 with pulse fan)	30200-16
Motor 1/3 HP 208/240 Volt 2 Speed (After F-79819 no pulse fan, After H-90436 with pulse fan)	30200-17
Switch Micro Convection Oven Door	30301-02
Switch Toggle On-Off	30303-06
Switch Toggle Spring Return	30303-16
Thermostat Safety 490°F Open	30401-09
Terminal Strip 3-Pole	30501-02
Contactors 3 Pole 24 VAC	30700-06
Contactors 2 Pole 24 VAC (Before H-90435)	30701-04
Contactors 2 Pole 30 Amp 24 VAC (After H-90436)	30701-05
Contactors 2 Speed Motor 24 VAC (480V Only, before H-90435)	30705-02
Contactors 2 Speed Motor 24 VAC (480V Only, After H-90436)	30705-03
Fuse 15 AMP 300 Volt	30900-10
Fuse Holder 15 Amp	30901-08
Transformer 120-208-240/24 VAC	31400-07
Transformer 480/24 VAC	31400-15
Pilot Light 28 VAC	31601-07
Lamp Socket	31602-04
Lamp Incandescent 250 Volt Clear	31603-04
Oven Lamp Lens (Watch Glass)	31604-01
Oven Lamp Lens Gasket	31604-02
Circuit Breaker 208/240 Volt 1-Pole	31800-01
Circuit Breaker 480 Volt 3-Pole	31800-04
Circuit Board Temperature Control	40101-17
Circuit Board Assembly Buzzer	40102-10
Probe Temperature Sensor	41100-08
Turnbuckle Assembly	50312-02
Door Left Hand	51100-45
Door Right Hand	51100-46
Panel Label (Before H-90435)	60301-58
Panel Label 2 Speed Motor (Before H-90435)	60301-73
Panel Label (After H-90436)	60301-102
Handle Assembly, Single Handle Oven	70603-15
Knob Damper Black	70701-25
Window Assembly, Oven Door	71301-04
Blower Wheel	71500-05
Bezel Control Board (Before H-90435)	72603-01
Bezel Fiber Spacer (Before H-90435)	20501-01
Bezel Screw, Short Qty. 1 (Before H-90435)	20102-19
Bezel Screw, Long Qty. 4 (Before H-90435)	20102-20
Bezel Washer (Before H-90435)	20201-13
Rack	50200-20
Rack Slide (Before H-37462)	50200-36
Rack Slide (After H-37462)	50200-93
Rack Extra Deep	50200-31
Rack Slide Extra Deep (Before _-38832)	50200-33
Rack Slide Extra Deep (After _-38832)	50200-94

## PARTS LIST ECCO-C

DESCRIPTION	PART NO.
Element ECCO Oven 208/240 Volt 11000 Watts	11090-16
Element ECCO Oven 480 Volt 11000 Watts	11090-18
Motor 1/3 HP 480 Volt	30200-03
Motor 1/3 HP 115/208/240 Volt	30200-12
Motor 1/3 HP 480 Volt 2 Speed (After Serial V-90436)	30200-16
Motor 1/3 HP 208/240 Volt 2 Speed (After Serial V-90436)	30200-17
Switch Micro Convection Oven Door	30301-02
Switch Toggle On-Off	30303-06
Switch Toggle Spring Return	30303-16
Thermostat Safety 490°F Open	30401-09
Thermostat 450°F Oven	30402-27
Terminal Block 24 Position Quick Disconnect	30503-01
Relay 240 VAC	30600-02
Contactors 3 Pole 24 VAC	30700-06
Contactors 2 Pole 208/240 VAC	30701-03
Contactors 2 Pole 30 Amp 24 VAC (After Serial V-90436)	30701-05
Fuse 15 AMP 300 Volt	30900-10
Fuse Holder 15 Amp	30901-08
Cable Ribbon Assembly	31110-01
Transformer 480/240 VAC	31400-04
Transformer 120-208/240/24 VAC	31400-07
Transformer 240/12 VAC	31400-26
Lamp Socket	31602-04
Lamp Incandescent 250 Volt Clear	31603-04
Oven Lamp Lens (Watch Glass)	31604-01
Oven Lamp Lens Gasket	31604-02
Circuit Breaker 208/240 Volt 1-Pole	31800-01
Circuit Breaker 480 Volt 3-Pole	31800-04
Circuit Board Assembly Buzzer	40102-10
Circuit Board Front Panel	40102-20
Circuit Board Front Panel Mrs. Fields	40102-21
Circuit Board Microprocessor	40102-44
Circuit Board Upgrade Kit (Only for units before G-71021)	60101-53
Snubber Low Voltage On Coil, 3-Pole Contactor	40705-02
Snubber Hi Voltage Contactor Circuit Feed 208/240V	40705-04
Snubber Hi Voltage Across Poles, 3-Pole Contact 208/240V	40705-05
Snubber Hi Voltage On Coil, 2-Pole Contactor 480V	40705-06
Snubber Hi Voltage Across Pole, 3-Pole Contactor 480V	40705-07
Snubber Low Voltage 24 Pole Terminal Block 480V	40705-08
Snubber Hi Voltage 24 Pole Terminal Block 480V	40705-09
Suppressor Low Voltage 24 Pole Terminal Block	40705-10
Suppressor Hi Voltage 24 Pole Terminal Block	40705-11
Probe Temperature Sensor	41100-08
Door Handle 11 1/2" Long Black "T" Style (Double Handle Ovens)	50800-12
Door Handle Bracket – Chrome (Single Handle Ovens)	50800-49-1
Door Handle Screw (Single Handle Ovens)	OBSOLETE
Door Handle Washer (Single Handle Ovens)	20104-50
Turnbuckle Assembly (Single Handle Ovens)	50312-02
Door Left Hand (Single Handle Ovens)	51100-45
Door Right Hand (Single Handle Ovens)	51100-46
Panel Label, Purple	60301-42
Panel Label Mrs. Fields	60301-93

## PARTS LIST ECCO-C

DESCRIPTION	PART NO.
Valve Manual Main Water Supply (Steam Units)	70400-02
Valve Manual Water Supply (Steam Units)	70402-08
Valve Solenoid 24/60V Water Supply (Steam Units)	70403-01
Regulator Water Supply (Steam Units)	70404-01
Handle Assembly, Single Handle Oven	70603-15
Knob Thermostat 450°F Oven (not used before D-57000)	70701-19
Knob Damper Black (not used before D-57000)	70701-25
Window Assembly, Oven Door	71301-04
Blower Wheel	71500-05
Blower Wheel (Steam Units)	51100-57
Orifice Water/Steam #60 DRL (Steam Units)	80405-01

## PARTS LIST ECCO-PP

DESCRIPTION	PART NO.
Element ECCO Oven 208/240 Volt 11000 Watts	11090-16
Element ECCO Oven 480 Volt 11000 Watts	11090-18
Motor 1/3 HP 480 Volt 2 Speed	30200-16
Motor 1/3 HP 208/240 Volt 2 Speed	30200-17
Switch Micro Convection Oven Door	30301-02
Switch Toggle On-Off	30303-06
Switch Toggle Spring Return	30303-16
Thermostat Safety 490°F Open	30401-09
Thermostat 450°F Oven	30402-27
Terminal Block 24 Position Quick Disconnect	30503-01
Relay 240 VAC	30600-02
Contactors 3 Pole 24 VAC (Heat)	30700-06
Contactors 2 Pole 24 VAC (208/240 VAC only)	30701-05
Contactors 2 Speed Motor 24 VAC (480V Only)	30705-03
Fuse 15 AMP 300 Volt	30900-10
Fuse Holder 15 Amp	30901-08
Cable Ribbon Assembly	31110-13
Transformer 480/24 VAC	31400-15
Transformer 240/12 VAC	31400-26
Lamp Socket	31602-04
Lamp Incandescent 250 Volt Clear	31603-04
Oven Lamp Lens (Watch Glass)	31604-01
Oven Lamp Lens Gasket	31604-02
Circuit Breaker 208/240 Volt 1-Pole	31800-01
Circuit Breaker 480 Volt 3-Pole	31800-04
Circuit Board Front Panel	40102-24
Circuit Board Microprocessor	40102-26
Circuit Board Microprocessor (with Modem)	40102-29
Probe Temperature Sensor	41100-08
Oven Rack	50200-20
Oven Rack Slide	50200-36
Turnbuckle Assembly	50312-02
Door Left Hand	51100-45
Door Right Hand	51100-46
Panel Label, Purple Plus	60301-116
Valve Manual Main Water Supply (Steam Units)	70400-02
Valve Manual Water Supply (Steam Units)	70402-08
Valve Solenoid 24/60V Water Supply (Steam Units)	70403-01
Regulator Water Supply (Steam Units)	70404-01
Handle Assembly, Single Handle Oven	70603-15
Knob Thermostat 450°F Oven	70701-28
Knob Damper Black	70701-25
Window Assembly, Oven Door	71301-04
Blower Wheel	71500-05
Blower Wheel (Steam Units)	51100-57
Orifice Water/Steam #60 DRL (Steam Units)	80405-01

## PARTS LIST ECCO-PT

DESCRIPTION	PART NO.
Element ECCO Oven 208/240 Volt 11000 Watts	11090-16
Element ECCO Oven 480 Volt 11000 Watts	11090-18
Motor 1/3 HP 480 Volt 2 Speed	30200-16
Motor 1/3 HP 208/240 Volt 2 Speed	30200-17
Switch Micro Convection Oven Door	30301-02
Switch Toggle Spring Return	30303-16
Thermostat Safety 490°F Open	30401-09
Thermostat 450°F Oven	30402-27
Terminal Block 24 Position Quick Disconnect	30503-01
Relay 240 VAC	30600-02
Contactors 3 Pole 24 VAC	30700-06
Contactors 2 Pole 24 VAC (208/240 VAC only)	30701-05
Contactors 2 Speed Motor 24 VAC (480 VAC only)	30705-03
Fuse 15 AMP 300 Volt	30900-10
Fuse Holder 15 Amp	30901-08
Cable Ribbon Assembly	31110-13
Transformer 480/24 VAC	31400-15
Transformer 240/12 VAC	31400-26
Lamp Socket	31602-04
Lamp Incandescent 250 Volt Clear	31603-04
Oven Lamp Lens (Watch Glass)	31604-01
Oven Lamp Lens Gasket	31604-02
Circuit Breaker 208/240 Volt 1-Pole	31800-01
Circuit Breaker 480 Volt 3-Pole	31800-04
Circuit Board Display	40102-25
Circuit Board Microprocessor	40102-26
Circuit Board Microprocessor (with Modem)	40102-29
Probe Temperature Sensor	41100-08
Oven Rack	50200-20
Oven Rack Slide	50200-36
Turnbuckle Assembly	50312-02
Door Left Hand	51100-45
Door Right Hand	51100-46
Panel Label, Purple Plus	60301-119
Valve Manual Main Water Supply (Steam Units)	70400-02
Valve Manual Water Supply (Steam Units)	70402-08
Valve Solenoid 24/60V Water Supply (Steam Units)	70403-01
Regulator Water Supply (Steam Units)	70404-01
Handle Assembly, Single Handle Oven	70603-15
Knob Thermostat 450°F Oven	70701-28
Knob Damper Black	70701-25
Window Assembly, Oven Door	71301-04
Blower Wheel	71500-05
Blower Wheel (Steam Units)	51100-57
Orifice Water/Steam #60 DRL (Steam Units)	80405-01