



# Service Manual

## Models: 151 - 286



**WARNING**

This manual must only be used by a qualified heating installer / service technician. Read all instructions, including this manual and the Armor Water Heater Installation and Operation Manual, before installing. Perform steps in the order given. Failure to comply could result in severe personal injury, death, or substantial property damage.



Save this manual for future reference.

# Contents

<b>CONTENTS</b> .....	2	<b>2. MAINTENANCE</b>	
Hazard Definitions.....	2	Maintenance and Annual Startup.....	20-24
<b>PLEASE READ BEFORE PROCEEDING</b> .....	3	<b>3. TROUBLESHOOTING</b>	
Handling Ceramic Fiber Materials.....	3	Before Troubleshooting.....	25
When servicing water heater.....	3	Check Control Module Fuses .....	25
Water heater operation.....	3	Table 3A - Troubleshooting Chart - No Display.....	26
<b>WHAT IS IN THIS MANUAL</b> .....	4	Checking Temperature Sensors .....	27
<b>1. SERVICE</b>		Table 3E - Troubleshooting Chart - Noisy System .....	28
The Armor Water Heater Display.....	5	Table 3F - Troubleshooting Chart - Fault Messages ..	29-35
Control Inputs.....	6	Combustion Analysis Procedure.....	36
Control Outputs.....	7	Table 3G - Flue Products.....	36
General Operation .....	8	Table 3H - Troubleshooting Chart - Combustion Levels..	36
Sequence of Operation .....	9	Gas Valve Adjustment Procedure.....	37
Display Panel Menu Access .....	10	Revision Notes .....	Back Cover
Display Panel Parameter Access.....	11		
Parameter Table.....	12-13		
Viewable and Changeable Control Parameters.....	14-19		

## Hazard definitions

The following defined terms are used throughout this manual to bring attention to the presence of hazards of various risk levels or to important information concerning the life of the product.

** DANGER** DANGER indicates an imminently hazardous situation which, if not avoided, will result in death or serious injury.

** WARNING** WARNING indicates a potentially hazardous situation which, if not avoided, could result in death or serious injury.

** CAUTION** CAUTION indicates a potentially hazardous situation which, if not avoided, may result in minor or moderate injury.

**CAUTION** CAUTION used without the safety alert symbol indicates a potentially hazardous situation which, if not avoided, may result in property damage.

**NOTICE** NOTICE indicates special instructions on installation, operation, or maintenance that are important but not related to personal injury or property damage.

## Please read before proceeding

### ⚠ WARNING

**Installer** – Read all instructions, including this manual and the Armor Water Heater Installation and Operation Manual, before installing. Perform steps in the order given.

Have this water heater serviced/inspected by a qualified service technician at least annually.

Failure to comply with the above could result in severe personal injury, death or substantial property damage.

### NOTICE

When calling or writing about the water heater – Please have the water heater model and serial number from the water heater rating plate.

Consider piping and installation when determining water heater location (see the Armor Water Heater Installation and Operation Manual).

Any claims for damage or shortage in shipment must be filed immediately against the transportation company by the consignee.

## Handling ceramic fiber materials

### REMOVAL OF COMBUSTION CHAMBER LINING

### ⚠ WARNING

The combustion chamber insulation in this appliance contains ceramic fiber material. Ceramic fibers can be converted to cristobalite in very high temperature applications. The International Agency for Research on Cancer (IARC) has concluded, “Crystalline silica in the form of quartz or cristobalite from occupational sources is carcinogenic to humans (Group 1)”. Normal operating temperatures in this appliance are below the level to convert ceramic fibers to cristobalite. Abnormal operating conditions would have to be created to convert the ceramic fibers in this appliance to cristobalite.

The ceramic fiber material used in this appliance is an irritant; when handling or replacing the ceramic materials it is advisable that the installer follow these safety guidelines.

■ Avoid breathing dust and contact with skin and eyes.

- Use NIOSH certified dust respirator (N95). This type of respirator is based on the OSHA requirements for cristobalite at the time this document was written. Other types of respirators may be needed depending on the job site conditions. Current NIOSH recommendations can be found on the NIOSH website at <http://www.cdc.gov/niosh/homepage.html>. NIOSH approved respirators, manufacturers, and phone numbers are also listed on this website.
- Wear long-sleeved, loose fitting clothing, gloves, and eye protection.

■ Apply enough water to the combustion chamber lining to prevent airborne dust.

■ Remove the combustion chamber lining from the water heater and place it in a plastic bag for disposal.

■ Wash potentially contaminated clothes separately from other clothing. Rinse clothes washer thoroughly.

### NIOSH stated First Aid.

- Eye: Irrigate immediately.
- Breathing: Fresh air.

## When servicing water heater –

- To avoid electric shock, disconnect electrical supply before performing maintenance.
- To avoid severe burns, allow the water heater to cool before performing maintenance.

## Water heater operation –

- Do not block flow of combustion or ventilation air to the water heater.
- Should overheating occur or gas supply fail to shut off, do not turn off or disconnect electrical supply to circulator. Instead, shut off the gas supply at a location external to the appliance.
- Do not use this water heater if any part has been under water. The possible damage to a flooded appliance can be extensive and present numerous safety hazards. Any appliance that has been under water must be replaced.

## What is in this manual?

### Service

#### The Armor water heater display

- Display panel readout, buttons and their functions

#### Control module inputs

- Control module inputs and options

#### Control module outputs

- Control module outputs and options

### General

- How the water heater operates
- How the control module operates
- Access modes -- user and installer
- Sequence of operation -- Water Heating

#### Control panel menu access

- Accessing programming mode and locating menus (See separate guide covering the PC interface.)

#### Control panel parameter access

- Accessing and changing parameters from the display panel

#### Quick start information -- parameter table

- An index of available adjustments and readouts, where to access them and where to find detailed information.

### Armor water heater operation

- General
- Data Logging
- Functions
- DHW Settings
- Anti-Cycling
- Control Modes
- Circulation Pumps
- BMS
- Service Notification

### Maintenance

- Service and maintenance schedules
- Address reported problems
- Inspect water heater area and water heater interior
- Clean condensate trap
- Check all piping for leaks
- Check air openings
- Flue vent system and air piping
- Check water system
- Check water heater relief valve
- Inspect ignition electrode
- Check ignition ground wiring
- Check all water heater wiring
- Check control settings
- Perform start-up and checks
- Check burner flame
- Check flame signal
- Check flue gas temperature
- General maintenance
- Review with owner
- Cleaning the water heater heat exchanger
- Oiled bearing circulators

### Troubleshooting

- Troubleshooting table - No display
- Checking temperature sensors
- Sensor tables
- Troubleshooting table - Fault messages displayed on the water heater interface
- Combustion analysis procedure
- Gas valve adjustment procedure

# 1 Service

## The Armor water heater display

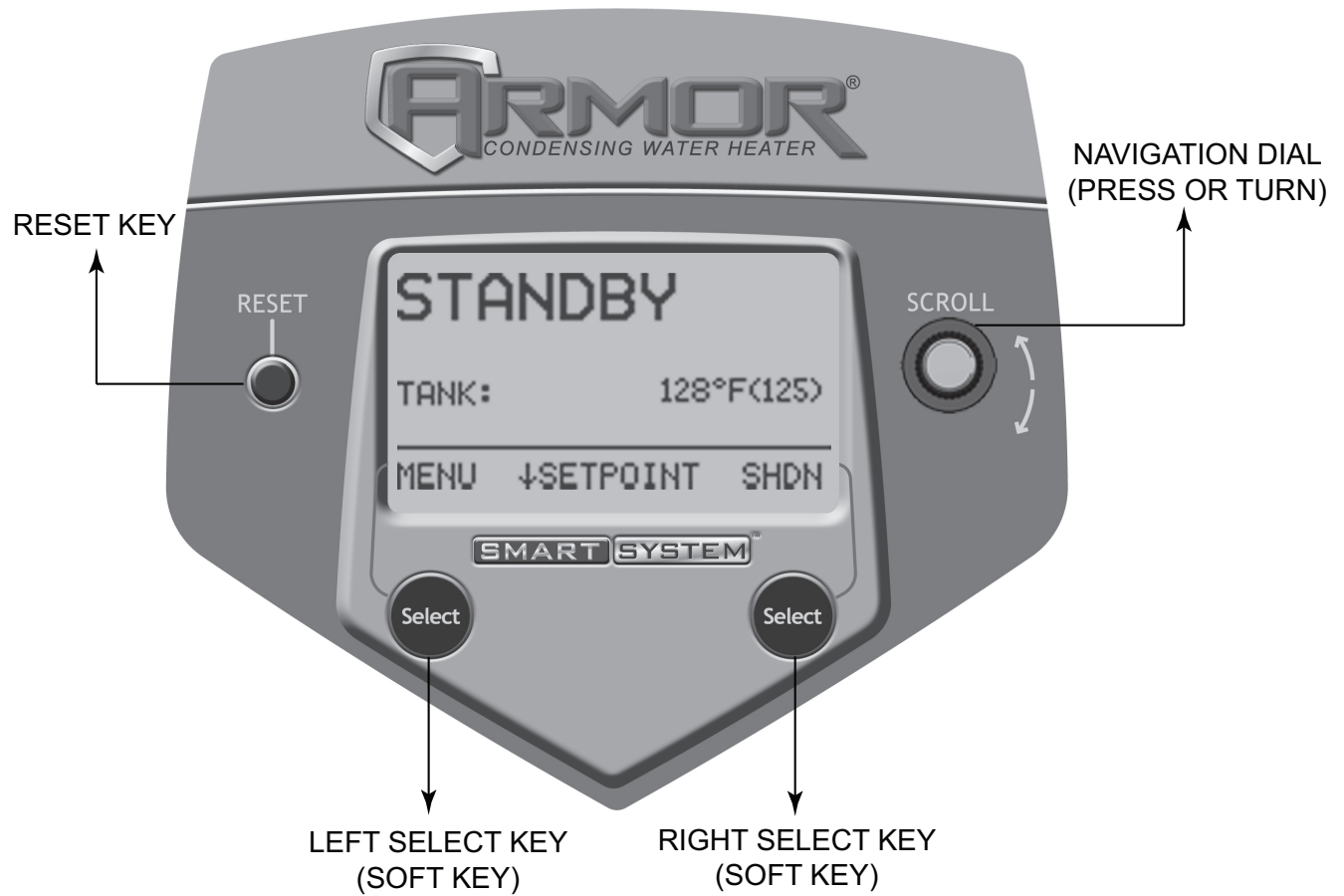

The information on the bottom of the display shows the functions of the two SELECT keys (on either corner), and the NAVIGATION dial (in the center):

MENU = Left SELECT Key

SETPOINTS = NAVIGATION Dial - Pressing Down

SHDN = Right SELECT Key

# 1 Service

## Control inputs

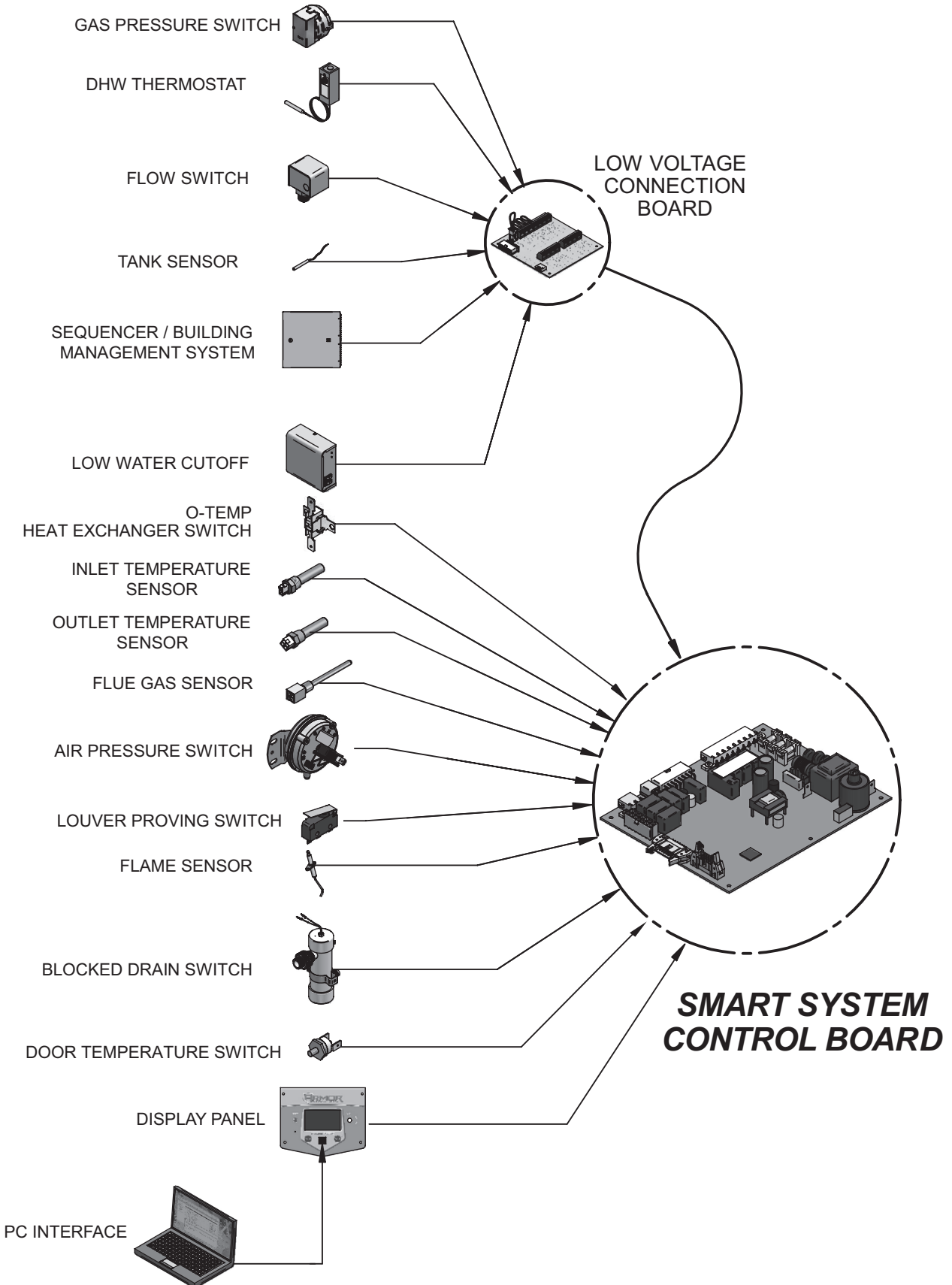

# 1 Service *(continued)*

## Control outputs

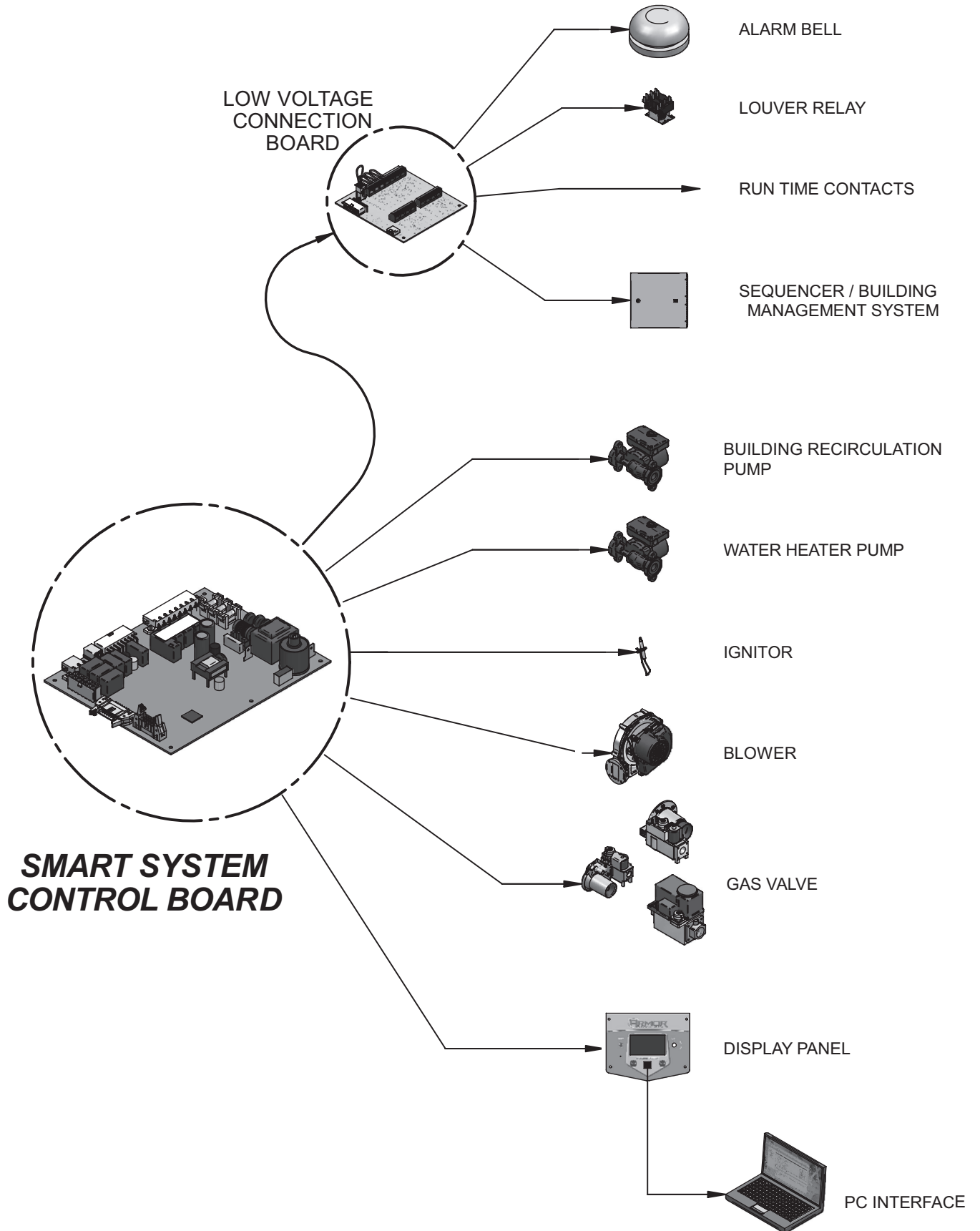

# 1 Service

## General Operation

### How the water heater operates

The Armor water heater uses an advanced stainless steel heat exchanger and an electronic control module that allows fully condensing operation. The blower pulls in gas and air and pushes flue products out of the water heater through the heat exchanger and flue piping. The control module regulates blower speed to control water heater firing rate. The gas valve senses the amount of air flowing into the water heater and allows only the right amount of gas to flow.

### Sequence of operation

Table 1A shows control module normal sequences of operation for water heating operation.

### Access modes

#### User

The user can adjust tank target temperatures by pressing the NAVIGATION dial when “↓SETPOINTS” is flashing at the bottom of the display. The date and time, and the temperature units can also be changed.

#### Installer

Most parameters are available only to the installer, accessible by entering the installer password (5309).

**Saving parameters** (reference the Parameter Table - Table 1D on pages 12 and 13 of this manual)

**NOTICE**

Please note that the brackets ([]) denote screen status.

#### To save parameters and exit programming:

















Press the RIGHT SELECT [SAVE] key and then press the RIGHT SELECT [HOME] key.

#### To enter a parameter and continue programming:

Press the RIGHT SELECT [SAVE] key 1 time to return to the parameter listings; press again to return to the menu listings. Remember to press the RIGHT SELECT [HOME] key when finished programming in order to save the changes made.

# 1 Service *(continued)*

**Table 1A** Sequence of operation

OPERATION	DISPLAY
1. The control will turn on the water heater pump (always ON except in Night Setback). The flow switch and/or LWCO must close.	<b>START</b>  TANK: 119 °F(125) <hr/> MENU  SCREEN SHDN
2. The control turns on power to the louver relay. The louver proving switch, air pressure switch, and blocked drain switch must close.	<b>START</b>  TANK: 119 °F(125) <hr/> MENU  SCREEN SHDN
3. The control starts the prepurge cycle.	<b>PRE-PURGE</b>  TANK: 119 ° F ( 125 ) <hr/> MENU  SCREEN SHDN
4. The control starts the trial for ignition by firing the spark electrode and opening the gas valve.	<b>IGNITION</b>  TANK: 119 ° F ( 125 ) <hr/> MENU  SCREEN SHDN
5. If flame is not detected after the sparking ends, the control will perform a postpurge, then start another prepurge cycle and try to light the burner again. The control will perform a total of 4 attempts before locking out.	<b>POST-PURGE</b>  TANK: 119 ° F ( 125 ) <hr/> MENU  SCREEN SHDN
6. If flame is detected, it holds the firing rate steady for a few seconds to let the flame stabilize, then it begins to modulate the firing rate based on a set point or some other command (such as a 0-10V BMS signal).	<b>42%</b>   TANK: 119 ° F ( 125 ) <hr/> MENU  SCREEN SHDN
7. Once the call for heat is satisfied, the control will turn off the burner. The blower will continue to run during the postpurge period.	<b>POST-PURGE</b> TANK: 128° F ( 125 ) <hr/> MENU  SCREEN SHDN
8. The water heater pump will continue to run for its respective pump delay time before turning off. A 60 second anti-cycle period will start, which will delay any new call for heat until it times out.	<b>BLOCKED</b> ANTI-CYCLING TANK: 128° F ( 125 ) <hr/> MENU  SCREEN SHDN
9. In Standby, ready to start a new cycle.	<b>STANDBY</b> TANK: 128°F(125) <hr/> MENU  SETPOINT SHDN

# 1 Service

## Display panel menu access









**Table 1B** Use this procedure to access menus from the display panel

BUTTON	SCREEN STATUS	OPERATION	DISPLAY
	[SHDN]	Press the RIGHT SELECT soft key [SHDN].	<b>STANDBY</b> TANK: 128°F(125) F MENU ↓SETPOINT SHDN
	[YES]	Press the LEFT SELECT soft key [YES].	<b>STANDBY</b> SHUTDOWN YES _____ NO
	[MENU]	Press and hold the LEFT SELECT soft key [MENU] for five (5) seconds.	<b>STANDBY</b> TANK: 128°F(125) F MENU ↓SETPOINT SHDN
		Rotate the NAVIGATION dial clockwise until 5 is displayed (first digit on the left).	<b>SHUTDOWN</b> PASSWORD 0000 EXIT ↓NEXT SAVE
		Press the NAVIGATION dial to select the next digit. Rotate the NAVIGATION dial clockwise until 3 is shown in the display.	<b>SHUTDOWN</b> PASSWORD 5000 EXIT ↓NEXT SAVE
		Press the NAVIGATION dial 2 times to move to the last digit. Rotate the NAVIGATION dial counterclockwise until 9 is displayed.	<b>SHUTDOWN</b> PASSWORD 5300 EXIT ↓NEXT SAVE
	[SAVE]	Press the RIGHT SELECT soft key [SAVE].	<b>SHUTDOWN</b> PASSWORD 5309 EXIT ↓NEXT SAVE
		Rotate the NAVIGATION dial counterclockwise to select a category.	<b>SHUTDOWN</b> >GENERAL DATA LOGGING FUNCTIONS DHW SETTINGS HOME ↵ SCROLL

# 1 Service *(continued)*

## Display panel parameter access

**Table 1C** This is a typical example of accessing a parameter, shown for parameter DHW Settings, TANK MIN Setpt

BUTTON	SCREEN STATUS	OPERATION	DISPLAY
<p><i>This example shows how to access parameter Temperature Settings. The first display shown is at the beginning of the menu listings, after entering the installer access code.</i></p>			
		Rotate the NAVIGATION dial counterclockwise until the arrow (>) is next to <b>DHW SETTINGS</b> .	<b>SHUTDOWN</b> >GENERAL DATA LOGGING FUNCTIONS DHW SETTINGS HOME ↵ SCROLL
		Press the NAVIGATION dial one time.	<b>SHUTDOWN</b> GENERAL DATA LOGGING FUNCTIONS >DHW SETTINGS HOME ↵ SCROLL
		Rotate the NAVIGATION dial counterclockwise until the arrow (>) is next to <b>TANK MIN SETPT</b> .	<b>SHUTDOWN</b> TANK SETPT: 125°F TANK SP OFFSET: 4°F TANK SP DIFF: 6°F >TANK MIN SETPT: 60°F HOME ↵ SCROLL
		Press the NAVIGATION dial one time.	<b>SHUTDOWN</b> TANK SETPT: 125°F TANK SP OFFSET: 4°F TANK SP DIFF: 6°F >TANK MIN SETPT: 60°F HOME ↵ SCROLL
		Rotate the NAVIGATION dial to the desired temperature.	<b>SHUTDOWN</b> TANK SETPT: 125°F TANK SP OFFSET: 4°F TANK SP DIFF: 6°F >TANK MIN SETPT: 60°F HOME ↵ SCROLL
	[SAVE]	Press the RIGHT SELECT soft key [SAVE] one time.	<b>SHUTDOWN</b> TANK SETPT: 125°F TANK SP OFFSET: 4°F TANK SP DIFF: 6°F >TANK MIN SETPT: 60°F HOME ↵ SCROLL SAVE
	[EXIT]	Press the LEFT SELECT soft key [EXIT] if all desired changes have been made.	<b>SHUTDOWN</b> GENERAL DATA LOGGING FUNCTIONS DHW SETTINGS EXIT HOME SAVE
	[HOME]	Press the LEFT SELECT soft key [HOME].	Parameters uploading...

# 1 Service

## Parameter table

**Table 1D** This table lists SMART SYSTEM control module parameters and where to access them

Menu	Description	See Page	User Access		Installer Access	
			Display	Modify	Display	Modify
<b>GENERAL</b>	Time and Date	14	Yes	Yes	Yes	Yes
	Software Version (read only)	14	No	No	Yes	No
	Temperature Units (°C/°F)	14	Yes	Yes	Yes	Yes
	DHW Night Setback Offset	14	No	No	Yes	Yes
	DHW Night Setback On Times	14	No	No	Yes	Yes
	DHW Night Setback Off Times	14	No	No	Yes	Yes
	Display Timeout	15	No	No	Yes	Yes
<b>DATA LOGGING</b>	Reset Log Errors	15	No	No	Yes	Yes
<b>FUNCTIONS</b>	Service Mode Delay	15	No	No	Yes	Yes
<b>DHW SETTINGS</b>	Tank Set Point	15	Yes	Yes	Yes	Yes
	Tank Set Point Offset	15	Yes	Yes	Yes	Yes
	Tank Set Point Differential	15	No	No	Yes	Yes
	Tank Minimum Set Point	15	No	No	Yes	Yes
	Tank Maximum Set Point	15	No	No	Yes	Yes
<b>ANTI-CYCLING</b>	Anti-Cycling Time	16	No	No	Yes	Yes
	Anti-Cycling Override Differential	16	No	No	Yes	Yes
	Ramp Delay	16	No	No	Yes	Yes
	Ramp Setting	16	No	No	Yes	Yes

# 1 Service (continued)

## Parameter table

Table 1D (continued from previous page) This table lists SMART SYSTEM control module parameters and where to access them

Menu	Description	See Page	User Access		Installer Access	
			Display	Modify	Display	Modify
CONTROL MODES	BMS Tstat Input	17	No	No	Yes	Yes
	BMS	17	No	No	Yes	Yes
	ModBus	17	No	No	Yes	Yes
	ModBus T/O	17	No	No	Yes	Yes
	Cascade Address	17	No	No	Yes	Yes
	Cascade Type	17	No	No	Yes	Yes
	Max Cascade Set Point	18	No	No	Yes	Yes
	Min On/Off Time	18	No	No	Yes	Yes
	Min Next On Time	18	No	No	Yes	Yes
	Boiler Size	18	No	No	Yes	Yes
CIRCULATION PUMPS	DHW Pump Delay	18	No	No	Yes	Yes
	DHW Pump Anti-Seize Delay	18	No	No	Yes	Yes
BMS	BMS Type (Power / Set Point)	18	No	No	Yes	Yes
	Volts at Min	18	No	No	Yes	Yes
	Volts at Max	18	No	No	Yes	Yes
	Rate at Min Volts	18	No	No	Yes	Yes
	Rate at Max Volts	19	No	No	Yes	Yes
	Set Point at Min Volts	19	No	No	Yes	Yes
	Set Point at Max Volts	19	No	No	Yes	Yes
	On Volts	19	No	No	Yes	Yes
	Off Differential Volts	19	No	No	Yes	Yes
SERVICE NOTIFICATION	Service Notification Months	19	No	No	Yes	Yes
	Service Notification Running Time	19	No	No	Yes	Yes
	Service Notification Cycles	19	No	No	Yes	Yes
	Reset Maintenance Reminder	19	No	No	Yes	Yes
	Installer Name and Phone Number	19	No	No	Yes	Yes

# 1 Service

## Viewable and changeable control parameters

### CAUTION

Before changing parameters, note the settings so that the unit can be returned to its original operating parameters.

### General

#### Time and Date

The control uses an internal clock for the night setback feature and for logging of events. For these features to work correctly, the clock must be set when the water heater is first installed or anytime the water heater has been powered off for more than four (4) hours. This parameter must be accessed to set the clock.

### NOTICE

The internal clock does not adjust for Daylight Savings Time and therefore, will require a manual adjustment.

The clock is automatically updated whenever a PC is connected and the Win\_Pro-Installer program is started.

#### Software Version

The software version allows the user to view the software version in use by the control. This software controls the operation of the water heater. When a new software version becomes available, the existing control can be replaced with a new control to update the software.

Software version is read only.

#### Temperature units (°C / °F)

The control can be configured to display temperature in either °C or °F. This parameter can be changed by the user or the installer by accessing the *Temperature Units parameter*. The default is °F.

#### Domestic Hot Water (DHW) Night Setback Offset

Once the unit's internal clock has been set correctly, the Night Setback feature can be used to program a lower set point during unoccupied times. The DHW can be programmed for night setback. When in night setback, the control reduces the set point by a fixed amount. For DHW, it subtracts the DHW night setback offset from the tank set point (*Tank Set point parameter*).

**NOTE:** The DHW night setback will not work without a tank sensor installed.

The installer may adjust the DHW night setback offset by accessing the *DHW Night Setback Offset parameter*. The minimum setting is 0°F (0°C) and the maximum setting is 90°F (50°C).

#### Domestic Hot Water (DHW) Night Setback On Times

This is the time in which the Night Setback Offset becomes active. There are 7 start times and 7 stop times each for the DHW night setback feature. The DHW Night Setback On Times may be set to any time within a 7-day week. These settings are referred to as triggers. Multiple start or stop triggers may be set within a single day, if desired. When a start trigger and a stop trigger are set to the same time, the stop trigger has priority. The installer may adjust the DHW start triggers in the *DHW Night Setback On Times parameter*. This screen shows the start trigger number, the day of the week, and the time of day.

### NOTICE

Please note that the brackets ([ ]) denote screen status.

1. When the screen is first accessed, start trigger number 1 is shown. If a different trigger number is desired, the installer can rotate the NAVIGATION dial until the desired trigger number is displayed. Once the desired trigger number is selected, the installer can press the NAVIGATION dial and the day of the week will start to flash.
2. The installer can adjust the day of the week to the one he wishes to set. Once the day is set, the installer can press the NAVIGATION dial and the hour will begin to flash.
3. After setting the hour, the installer can press the NAVIGATION dial and the minutes will flash. Once all settings have been made, the installer can press the RIGHT SELECT [SAVE] key. The installer can now select a different trigger and adjust the settings for that trigger.
4. Once all adjustments are made, the installer can press the RIGHT SELECT [SAVE] key to save all of the new settings and return to the **General** menu, or press the LEFT SELECT [EXIT] key to return to the **General** menu without saving the changes.

#### Domestic Hot Water (DHW) Night Setback Off Times

The stop triggers for the DHW night setback feature can be adjusted by accessing *DHW Night Setback Off Times parameter*.

#### Night Setback Override

Any Night Setback On trigger currently active or scheduled within the next seven (7) days can be skipped. To skip a trigger, rotate the NAVIGATION dial until the arrow (>) is next to the trigger you wish to skip. Press the NAVIGATION dial once. "SK" will appear next to that trigger to indicate that it will be skipped. You can restore an upcoming trigger by selecting that trigger, and pressing the NAVIGATION dial again. The "SK" next to that trigger will disappear.

# 1 Service *(continued)*

To save any changes and return to the Home Screen, press the RIGHT SELECT [HOME] key. To return to the Status Screen without saving the changes, press the LEFT SELECT [EXIT] key.

## Display Timeout

This is the time in which the display remains illuminated. The range is 10 seconds to 10 minutes. The default is 3 minutes.

## Data Logging

### Reset log errors

The reset log errors function clears the last 10 errors log.

## Functions

### Service Mode Delay

By pressing the pin button on the front of the display for five (5) seconds, the control will be placed in Service Mode. This will override all other heat demands. The Service Mode allows the installer to set the unit to any firing rate for the purpose of combustion analysis. The delay sets the length of time the water heater will stay in the Service Mode if no keys have been pressed before going back to its original state. This parameter can only be changed by the installer by accessing the *Service Mode Delay parameter*. The time range of this parameter is 1 to 10 minutes. The default value is 10 minutes.

## DHW Settings

### DHW Tank Set Point

By installing a tank sensor, the SMART SYSTEM control can perform the tank thermostat function. The SMART SYSTEM control automatically detects the presence of this sensor, and generates a DHW call for heat when the tank temperature drops below the tank set point differential (*Tank Set point Differential parameter*), and finishes the call for heat when the tank temperature reaches tank set point + offset. This parameter can be changed by the installer by accessing the *DHW Tank Set point parameter*. The temperature range of this parameter tank minimum set point to tank maximum set point. The default value is 125°F (52°C).

### Tank Set Point Offset

The tank set point offset measures how far the actual temperature must go above the set point before the call for heat ends (the water heater will turn off). This parameter can be changed by the installer by accessing the *Tank Set Point Offset parameter*. The temperature range of this parameter is 0°F (0°C) to 10°F (30°C). The default value is 4°F (6°C).

### Tank Set Point Differential

When a tank sensor is installed, the tank temperature must drop this amount below the tank set point (*DHW Tank Set point parameter*) before the water heater turns back on. The installer can adjust this setting by accessing the *Tank Set point Differential parameter*. The minimum setting is 0° (0°C), and the maximum is 40°F (22°C). The default setting is 6°F (3°C).

### Tank Minimum Set Point

This setting controls the minimum tank set point for the tank temperature. The installer can adjust this by accessing the *Tank Minimum Set point parameter*. The minimum setting is 60°F (16°C) and the maximum setting is the maximum tank set point (*Tank Maximum Set point parameter*). The default value is 60° (16°C).

### Tank Maximum Set Point

This setting controls the maximum tank set point for the tank temperature. The installer can adjust this by accessing the *Tank Maximum Set point parameter*. The minimum setting is the minimum tank set point (*Tank Minimum Set point parameter*) and the maximum setting is 190°F (88°C). The default value is 140°F (60°C).

# 1 Service

## Anti-Cycling

### Anti-Cycling Time

Once a SH demand has been satisfied, a set amount of time must elapse before the control will respond to a new SH demand. The control will block the new heat demand and anti-cycling will be shown in the display until the time has elapsed or the water temperature drops below the *Anti-Cycling Override Differential parameter*. This parameter can be changed by the installer by accessing the *Anti-Cycling Time parameter*. The time range for this parameter is 1 minute to 10 minutes. The default value is 1 minute.

### Anti-Cycling Override Differential

The control will bypass the anti-cycling time if the inlet water temperature drops too much. The control will use the inlet water temperature the water heater was at when it shut off as the starting point. If the inlet temperature drops below the temperature parameter the control will abort anti-cycling and allow the water heater to fire. This parameter can be changed by the installer by accessing the *Anti-Cycling Override Differential parameter*. The temperature range of this parameter is 0°F (0°C) to 54°F (30°C). The default value is 10°F (6°C).

### Ramp Delay (Enable / Disable)

This parameter allows the installer to enable or disable the DHW ramp delay. The default setting is disabled.

## Ramp Settings

**NOTICE**

Please note that the brackets ([]) denote screen status.

The SMART SYSTEM control can be programmed to limit the firing rate for a fixed period of time at the start of a DHW demand. There are six (6) possible limits, each with their own time delay. The first limit applies as soon as the burner starts. Once its time delay expires, the second limit is applied and its timer begins. The control steps through these limits until the 6th (sixth) limit expires. Note, however, that the 6th limit will also limit the rate for the rest of that heat demand. The installer can adjust the firing limits and time delays by accessing the *Ramp Settings parameter*. Once this parameter is selected, the screen will show the step number, the time delay for that step and the limit value corresponding with that step. If the installer wishes to adjust one of the values in that step, he can press the NAVIGATION dial until the value he wishes to change is flashing. The installer can then rotate the NAVIGATION dial to adjust that value. If the installer presses the RIGHT SELECT [SAVE] key while the limit value is flashing, the step value will flash again. The installer can then select the next step and adjust the delay and limit values corresponding with that step.

When finished, the installer can press the RIGHT SELECT [SAVE] key to store the new settings, or the LEFT SELECT [EXIT] key to return to the *Anti-Cycling* parameter list without saving the changes. The delay value can be set between 0 minutes and 20 minutes. The limit value can be set between 0% and 100%.

Figure 1-1 Ramp Delay Interval

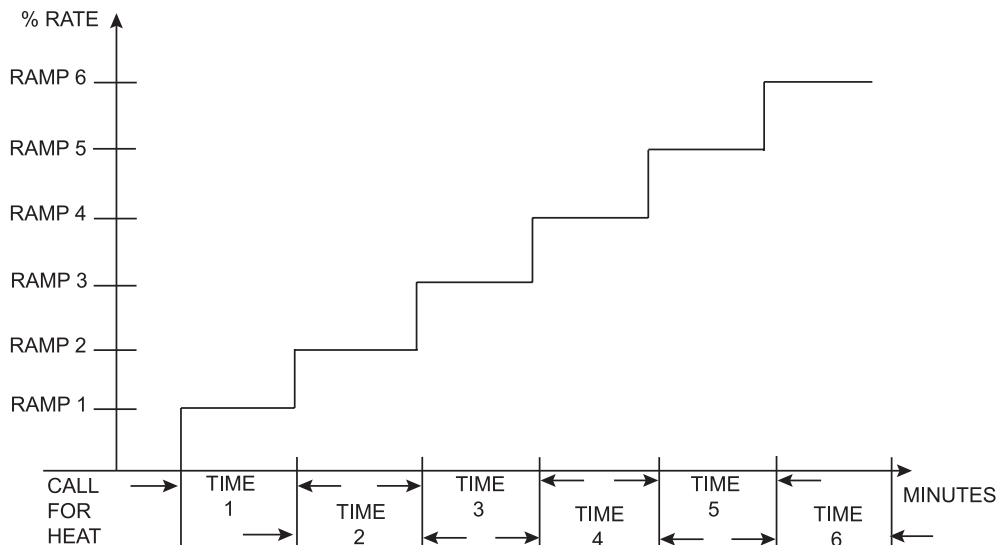

# 1 Service *(continued)*

## Control modes

### BMS Thermostat Input

When controlling the water heater through the 0 - 10V BMS input or through ModBus, the water heater can be enabled one of two ways. With the *BMS Thermostat Input parameter* set to ACTIVE, the water heater will be enabled by closing the tank thermostat input. When set to INACTIVE, the water heater will be enabled by the voltage level on the 0 - 10V input (in the case of 0 - 10V BMS control), or the 0 - 10V input value received through ModBus. The default value is INACTIVE.

### BMS

The set point or modulation of the water heater may be controlled through the 0 - 10V BMS input or through ModBus. When the *BMS parameter* is set to INACTIVE, the 0 - 10V input will be ignored. When set to ACTIVE, the set point or modulation will be controlled by the voltage on the 0 - 10V input (in the case of 0 - 10V BMS control), or the 0 - 10V input value received through ModBus. The default value is INACTIVE.

### ModBus

When BMS is set to ACTIVE (see BMS) and the water heater is being controlled through ModBus, set *ModBus parameter* to ACTIVE. Otherwise, set the *ModBus parameter* to INACTIVE. Note that the water heater can still be monitored by ModBus with this parameter set to INACTIVE. The default value is INACTIVE.

### ModBus T/O

The ModBus T/O is the amount of time the unit controls will wait to receive a communication string from the BMS controller before reverting back to its own internal parameters. This parameter is adjustable by the installer by accessing the *ModBus T/O parameter*. The adjustment range of this parameter is 5 seconds to 2 minutes. The default value is 10 seconds.

### Cascade Address

The water heater designated as the Leader needs to be programmed with address 0. All the Member water heaters require addresses from 1 to 7, and the addresses must be different for each Member. The addresses can be in any order, regardless of the order in which the units are wired together. This parameter is adjustable by the installer by accessing the *Cascade Address parameter*. The tank sensor must be connected to the Leader water heater. The default address is 1.

## Cascade Type

There are two (2) options for the way a Cascade divides the load between its heaters. The first is Lead/Lag, designated as L/L in the menu. This method is used when it is desired to have the least amount of total flow through the water heaters. This method will modulate the last two (2) water heaters. This provides for smooth transitions when a water heater turns on or off. When the last water heater reaches 100% and the calculated load is still increasing, it will start the next water heater at 20% and reduce the previous water heater to 80%, thus eliminating the sudden jump in total output of the Cascade. When the calculated load is decreasing and the last water heater gets down to 20% fire, it will hold it there and start lowering the firing rate on the next-to-last water heater. When the next-to-last water heater reaches 20%, it will turn the last water heater off and raise the rate of the next-to-last water heater to 40%, thus eliminating the sudden drop in total output of the Cascade.

The other Cascade divider method is Efficiency Optimization, designated as EFF in the menu. This method is used, as the name implies, when it is desired to have the most efficient system. When the first water heater reaches a certain rate (default = 90%), it lowers its rate to 45% and turns on the next water heater at 45%. The two (2) water heaters then modulate at the same rate.

As the calculated load increases further and both water heaters ramp up to 90%, it lowers the rate of the first two (2) water heaters to 60% and brings the next water heater on at 60%. The three (3) water heaters then modulate together. As the calculated load decreases, the water heaters will reach a lower threshold (default = 30%), at which time the last water heater (the third in our example) will turn off and the Cascade will increase the rates of the remaining water heaters to provide the equivalent total output as before ( $(3 \times 30\%) / 2 = 45\%$  in our example).

Efficiency optimization is automatically selected when heaters of different sizes are programmed into the Leader water heater (see *Boiler Size* on page 18).

# 1 Service

## Maximum Cascade Set Point

This parameter determines the set point used by the individual water heaters in a Cascade. When a water heater is commanded to fire by the Leader water heater, it will attempt to achieve this temperature at its outlet. The Leader water heater will limit the modulation of the water heaters in order to hold the temperature at the tank sensor to the user set point. If any of the water heater outlet temperatures reach the maximum cascade set point, the water heater will then modulate down on its own in order to keep its outlet temperature within the maximum cascade set point. Therefore, this parameter can be used to limit the outlet temperatures of all the water heaters in a Cascade. This parameter is adjustable by the installer by accessing the *Maximum Cascade Set Point* parameter. The temperature range of this parameter is 32° (0°C) to 190°F (88°C). The default maximum cascade set point is 185°F (85°C).

## Minimum On/Off Time

In order to prevent units in a Cascade from short cycling, this parameter defines the minimum ON and OFF time for each unit. The installer can adjust this time by accessing the *Minimum On/Off Time* parameter. The minimum setting is 0 seconds and the maximum setting is 10 minutes. The default is 30 seconds.

## Minimum Next On Time

In order to reduce the risk of temperature overshoot with a Cascade, this parameter defines the minimum time delay from starting one unit until the next unit may be started. The installer can adjust this time delay by accessing the *Minimum Next On Time* parameter. The minimum setting is 0 minutes and the maximum setting is 10 minutes. The default is 60 seconds.

## Boiler Size

When boilers of different sizes are connected together in a Cascade, the Leader boiler has to know the size of each boiler in that Cascade. The *Boiler Size* parameters allow the installer to program the sizes based on the Cascade address. This screen shows the Cascade address and the size of the boiler with that address (in BTU/hr):

1. When the Boiler Size screen is first accessed, Cascade Address 0 (Leader) is shown.
2. Press the NAVIGATION dial to access the first digit of the boiler size. Rotate the NAVIGATION dial to adjust the first digit. To access the next digit, press the NAVIGATION dial again. Continue this process until the correct boiler size (to the nearest 1000 BTU/hr) is shown. Press the RIGHT SELECT [SAVE] key.
3. Rotate the NAVIGATION dial to select the address of the next boiler in the Cascade. Repeat Step 2.
4. Once the size of the last boiler in the Cascade has been entered and saved, press the LEFT SELECT [EXIT] key to return to the Control Modes menu.
5. If no other parameters are to be adjusted, press the RIGHT SELECT [HOME] key to save the new settings and return to the Status screens.

The SMART SYSTEM control automatically uses the Efficiency Optimization Cascade type when controlling boilers of different sizes.

## Circulation pumps

### DHW Pump Delay

The DHW pump delay parameter sets the length of time the DHW pump (if connected) will run after a DHW demand has been satisfied. This parameter is adjustable by the installer by accessing the *DHW Pump Delay* parameter. The time range for this parameter is 10 seconds to 40 minutes. The default time is 1 minute.

### DHW Pump Anti-Seize Delay

If the water heater pump does not run for 24 hours, it will be turned on briefly to prevent it from seizing. The length of time it runs is determined by the *DHW Pump Anti-Seize Delay* parameter. The range of this setting is 0 seconds to 50 minutes. The default setting is 20 seconds.

## BMS

### BMS Type

When programmed for BMS control through the 0 - 10V BMS input or through ModBus, the 0 - 10V signal can be interpreted as either a modulation command or a set point. When the *BMS Type* parameter is set to POWER, the 0 - 10V signal will control the modulation. When set to SETPOINT, the 0 - 10V signal will control the tank set point. The default setting is SETPOINT.

### Volts at Minimum

When programmed for BMS control through the 0 - 10V BMS input or through ModBus, the *Volts at Minimum* parameter should be set to the minimum voltage signal sent to the SMART SYSTEM control. The range of this parameter is 0.0V to the *Volts at Maximum* value. The default setting is 2.0V.

### Volts at Maximum

When programmed for BMS control through the 0 - 10V BMS input or through ModBus, the *Volts at Maximum* parameter should be set to the maximum voltage signal sent to the SMART SYSTEM control. The range of this parameter is the *Volts at Minimum* value to 10.0V. The default value is 10.0V.

### Rate at Minimum Volts

When programmed for BMS control through the 0 - 10V BMS input or through ModBus and the BMS Type is programmed as POWER, the modulation percentage represented by the *Volts at Minimum* parameter is set by the *Rate at Minimum Volts* parameter. The minimum value is 0% and the maximum is the Rate at Maximum Volts setting. The default value is 20%.

# 1 Service *(continued)*

## Rate at Maximum Volts

When programmed for BMS control through the 0 - 10V BMS input or through ModBus and the BMS Type is programmed as POWER, the modulation percentage represented by the *Volts at Maximum* parameter is set by the *Rate at Maximum Volts* parameter. The minimum value is the *Rate at Minimum Volts* setting and the maximum is 100%. The default value is 100%.

## Set Point at Minimum Volts

When programmed for BMS control through the 0 - 10V BMS input or through ModBus and the BMS Type is programmed as SETPOINT, the set point represented by the *Volts at Minimum* parameter is set by the *Set Point at Maximum Volts* parameter. The minimum value is 32°F (0°C) and the maximum is the *Set Point at Maximum Volts* setting. The default value is 70°F (21°C).

## Set Point at Maximum Volts

When programmed for BMS control through the 0 - 10V BMS input or through ModBus and the BMS Type is programmed as SETPOINT, the set point represented by the *Volts at Maximum* parameter is set by the *Set Point at Maximum Volts* parameter. The minimum value is the *Set Point at Minimum Volts* setting and the maximum is 190°F (88°C). The default value is 180°F (82°C).

## On Volts

When programmed for BMS control through the 0 - 10V BMS input or through ModBus and the BMS Thermostat Input is set to INACTIVE, the *On Volts* parameter determines the 0 - 10V BMS input voltage at which the water heater is enabled. The minimum value is 0.5V and the maximum is 10.0V. The default value is 2.0V.

## Off Differential Volts

When programmed for BMS control through the 0 - 10V BMS input or through ModBus and the BMS Thermostat Input is set to INACTIVE, the *Off Differential Volts* parameter determines how far below the *On Volts* setting the 0 - 10V BMS input voltage must be in order to disable the water heater. The minimum value is 0.2V and the maximum is the *On Volts* setting. The default value is 1.0V.

## Service Notification

### Service Notification in Months

When the water heater control determines that a scheduled service is due based on days of installation, the water heater display will alternate the standard water heater display text with the message SERVICE DUE every 5 seconds. This parameter is adjustable by the installer by accessing the *Service Notification in Months* parameter. The time range for this parameter is 0 months to 100 months. The default time is 12 months.

This feature has been disabled by the manufacturer. To enable this feature change the *Service Notification in Months* parameter to the desired time range.

### Service Notification Running Time

When the water heater control determines that a scheduled service is due based on the hours of actual operation, the water heater display will turn yellow and a new status screen will appear informing the installer that maintenance is required. This parameter is adjustable by the installer by accessing the *Service Notification Running Time* parameter. The time range for this parameter is 0 hours to 17,500 hours. The default time is 8,760 hours.

### Service Notification Cycles

When the water heater control determines that a scheduled service is due based on the number of water heater cycles, the water heater display will alternate the standard water heater display text with the message SERVICE DUE every 5 seconds. This parameter is adjustable by the installer by accessing the *Service Notification Cycles* parameter. The range for this parameter is 0 cycles to 100,000 cycles. The default is 50,000 cycles.

### Reset Maintenance Reminder

Once service has been completed, the service notification counter should be reset. This parameter can be reset by the installer by accessing the *Reset Maintenance Reminder* parameter. Once accessed, press the RESET key to reset the service notification counter.

### Installer Name and Phone Number

**NOTICE**

Please note that the brackets ([]) denote screen status.

When a Maintenance Reminder timer or counter has expired, a Maintenance Reminder screen will appear on the display. By programming the installer's name and phone number, this information will appear on the Maintenance Reminder Screen at that time. This can be programmed by accessing the *Service Name and Phone Number* parameter. When selected, another menu will appear with PHONE and NAME.

1. Rotate the NAVIGATION dial to point to the name/phone number to program and press the NAVIGATION dial. The screen will now display the selected item (either PHONE or NAME).
2. Press the NAVIGATION dial again. A cursor will appear at the bottom of the screen. By rotating the NAVIGATION dial, various numbers and characters will appear. When the desired number/character is found, press the NAVIGATION dial. The cursor will move to the next position.
3. Repeat this procedure until the entire message is entered. If you make a mistake and wish to back up one character, rotate the NAVIGATION dial until the back arrow (←) character is displayed and press the NAVIGATION dial.
4. When finished, press the RIGHT SELECT [SAVE] key to return to the previous menu.

## 2 Maintenance

### Maintenance and annual startup

Table 2A Service and Maintenance Schedules

<b>Service technician</b> (see the following pages for instructions)		<b>Owner maintenance</b>	
<b>ANNUAL START-UP</b>	<b>General:</b>		
	<ul style="list-style-type: none"> <li>• Address reported problems</li> <li>• Inspect interior; clean and vacuum if necessary;</li> <li>• Clean condensate trap and fill with fresh water</li> <li>• Check for leaks (water, gas, flue, condensate)</li> <li>• Verify flue and air lines in good condition and sealed tight</li> <li>• Check system water pressure/system piping/expansion tank</li> <li>• Check control settings</li> <li>• Check ignition and flame sense electrodes (sand off any deposits; clean and reposition)</li> <li>• Check wiring and connections</li> <li>• Perform start-up checkout and performance verification per Section 10 in the Armor Installation and Operation Manual.</li> <li>• Flame inspection (stable, uniform)</li> <li>• Flame signal (at least 10 microamps at high fire)</li> <li>• Clean the heat exchanger if flue temperature is more than 54°F above return water temperature.</li> <li>• Check Delta T (Temperature Rise)</li> </ul>	<b>Daily</b>	<ul style="list-style-type: none"> <li>• Check water heater area</li> </ul>
	<p><b>If combustion or performance indicate need:</b></p> <ul style="list-style-type: none"> <li>• Clean heat exchanger</li> <li>• Remove and clean burner using compressed air only</li> <li>• Clean the blower wheel</li> </ul>	<b>Monthly</b>	<ul style="list-style-type: none"> <li>• Check vent piping</li> <li>• Check air piping</li> <li>• Check air and vent termination screens</li> <li>• Check relief valve</li> <li>• Check condensate drain system</li> <li>• Check air vents</li> <li>• Check Delta T (Temperature Rise)</li> <li>• Remove debris from Y-strainer per manufacturer's instructions</li> <li>• Check building recirculation filter (if filter required)</li> </ul>
		<b>Every 6 months</b>	<ul style="list-style-type: none"> <li>• Check water heater piping (gas and water) for leaks</li> <li>• Operate relief valve</li> <li>• Check water chemistry</li> </ul>

## 2 Maintenance *(continued)*

**⚠ WARNING** Follow the service and maintenance procedures given throughout this manual and in component literature shipped with the water heater. Failure to perform the service and maintenance could result in damage to the water heater or system. Failure to follow the directions in this manual and component literature could result in severe personal injury, death, or substantial property damage.

**⚠ WARNING** The water heater should be inspected annually only by a qualified service technician. In addition, the maintenance and care of the water heater designated in Table 2A and explained on the following pages must be performed to assure maximum water heater efficiency and reliability. Failure to service and maintain the water heater and system could result in equipment failure.

**⚠ WARNING** Electrical shock hazard – Turn off power to the water heater before any service operation on the water heater except as noted otherwise in this instruction manual. Failure to turn off electrical power could result in electrical shock, causing severe personal injury or death.

### Address reported problems

1. Inspect any problems reported by the owner and correct before proceeding.

### Inspect water heater area

1. Verify that water heater area is free of any combustible materials, gasoline and other flammable vapors and liquids.
2. Verify that air intake area is free of any of the contaminants listed in Section 1 of the Armor Water Heater Installation and Operation Manual. If any of these are present in the water heater intake air vicinity, they must be removed. If they cannot be removed, reinstall the air and vent lines per this manual and the Armor Water Heater Installation and Operation Manual.

### Inspect water heater interior

1. Remove the front access cover and inspect the interior of the water heater.
2. Vacuum any sediment from inside the water heater and components. Remove any obstructions.

### Clean condensate trap

1. Inspect the condensate drain line, condensate PVC fittings, and condensate trap.
2. Remove the PVC cap retaining screw from the PVC cap (FIG. 2-1).
3. Remove the 2 inch PVC cap with the switch located at the top of the trap (FIG. 2-1).
4. Remove any sediment in the trap.
5. Fill with fresh water until the water begins to pour out of the drain.
6. Replace the cap. Press the cap onto the trap until the cap makes contact with the drain.
7. Replace the retaining screw.

**Figure 2-1** Condensate Trap

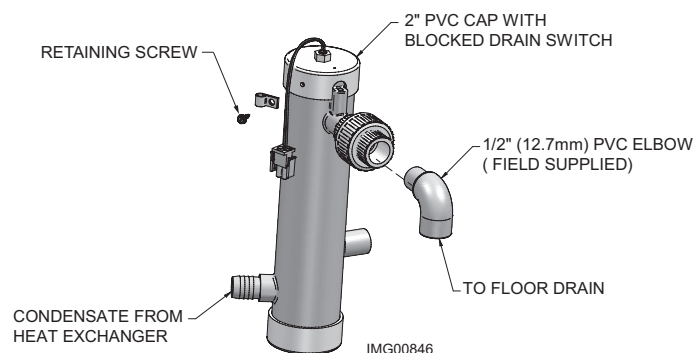

**⚠ WARNING** The condensate trap must be filled with water during all times of water heater operation to avoid flue gas emission from the condensate drain line. Failure to fill the trap could result in severe personal injury or death.

### Check all piping for leaks

**⚠ WARNING** Eliminate all system or water heater leaks. Leaking water may cause severe property damage.

1. Inspect all water and gas piping and verify to be leak free.
2. Look for signs of leaking lines and correct any problems found.
3. Check gas line using the procedure found in Section 7 - Gas Connections of the Armor Water Heater Installation and Operation Manual.

## 2 Maintenance

### Flue vent system and air piping

1. Visually inspect the entire flue gas venting system and air piping for blockage, deterioration or leakage. Repair any joints that show signs of leakage. Verify that air inlet pipe is connected and properly sealed.
2. Verify that water heater vent discharge and air intake are clean and free of obstructions.

**WARNING** Failure to inspect for the above conditions and have them repaired can result in severe personal injury or death.

### Check water system

1. Verify all system components are correctly installed and operational.
2. Verify system pressure is at least 12 PSI.
3. Watch the system pressure as the water heater heats up (during testing) to ensure pressure does not rise too high. Excessive pressure rise indicates expansion tank sizing or performance problem.
4. Inspect automatic air vents and air separators. Remove air vent caps and briefly push valve to flush vent. Replace caps. Make sure vents do not leak. Replace any leaking vents.

### Check expansion tank

1. Expansion tanks provide space for water to move in and out as the water expands due to temperature increase or contracts as the water cools. Tanks may be diaphragm or bladder type. See Section 6 - System Piping of the Armor Water Heater Installation and Operation Manual for suggested best location of expansion tanks and air eliminators.

### Check water heater relief valve

1. Inspect the relief valve and lift the lever to verify flow. Before operating any relief valve, ensure that it is piped with its discharge in a safe area to avoid severe scald potential. Read Section 6 - System Piping of the Armor Water Heater Installation and Operation Manual before proceeding further.

**WARNING** Safety relief valves should be re-inspected AT LEAST ONCE EVERY THREE YEARS, by a licensed plumbing contractor or authorized inspection agency, to ensure that the product has not been affected by corrosive water conditions and to ensure that the valve and discharge line have not been altered or tampered with illegally. Certain naturally occurring conditions may corrode the valve or its components over time, rendering the valve inoperative. Such conditions are not detectable unless the valve and its components are physically removed and inspected. This inspection must only be conducted by a plumbing contractor or authorized inspection agency – not by the owner. Failure to re-inspect the water heater relief valve as directed could result in unsafe pressure buildup, which can result in severe personal injury, death, or substantial property damage.

**WARNING** Following installation, the valve lever must be operated AT LEAST ONCE A YEAR to ensure that waterways are clear. Certain naturally occurring mineral deposits may adhere to the valve, rendering it inoperative. When manually operating the lever, water will discharge and precautions must be taken to avoid contact with hot water and to avoid water damage. Before operating lever, check to see that a discharge line is connected to this valve directing the flow of hot water from the valve to a proper place of disposal. Otherwise severe personal injury may result. If no water flows, valve is inoperative. Shut down the water heater until a new relief valve has been installed.

2. After following the above warning directions, if the relief valve weeps or will not seat properly, replace the relief valve. Ensure that the reason for relief valve weeping is the valve and not over-pressurization of the system due to expansion tank waterlogging or undersizing.

## 2 Maintenance *(continued)*

### Inspect ignition and flame sense electrodes

1. Remove the ignition and flame sense electrodes from the water heater heat exchanger access cover.
2. Remove any deposits accumulated on the ignition/flame sense electrode using sandpaper. If the electrodes cannot be cleaned satisfactorily, replace with new ones.
3. Replace ignition/flame sense electrode, making sure gasket is in good condition and correctly positioned.

### Check ignition ground wiring

1. Inspect water heater ground wire from the heat exchanger access cover to ground terminal strip.
2. Verify all wiring is in good condition and securely attached.
3. Check ground continuity of wiring using continuity meter.
4. Replace ground wires if ground continuity is not satisfactory.

### Check all water heater wiring

1. Inspect all water heater wiring, making sure wires are in good condition and securely attached.

### Check control settings

1. Set the SMART SYSTEM control module display to Parameter Mode and check all settings. See Section 1 of this manual. Adjust settings if necessary. See Section 1 of this manual for adjustment procedures.
2. Check settings of external limit controls (if any) and adjust if necessary.

### Perform start-up and checks

1. Start water heater and perform checks and tests specified in Section 10 - Start-up of the Armor Water Heater Installation and Operation Manual.
2. Verify cold fill pressure is correct and that operating pressure does not go too high.

### Check burner flame

1. Inspect flame through observation window.
2. If the flame is unsatisfactory at either high fire or low fire, turn off water heater and allow water heater to cool down. Remove the burner and clean it thoroughly using a vacuum cleaner or compressed air. Do not use compressed air to clean burner if performed inside a building.
3. Remove the burner, reference FIG. 2-2 below.
4. When replacing the burner, ensure gasket is in good condition and positioned correctly (FIG. 2-2).

**Figure 2-2 Burner Assembly**

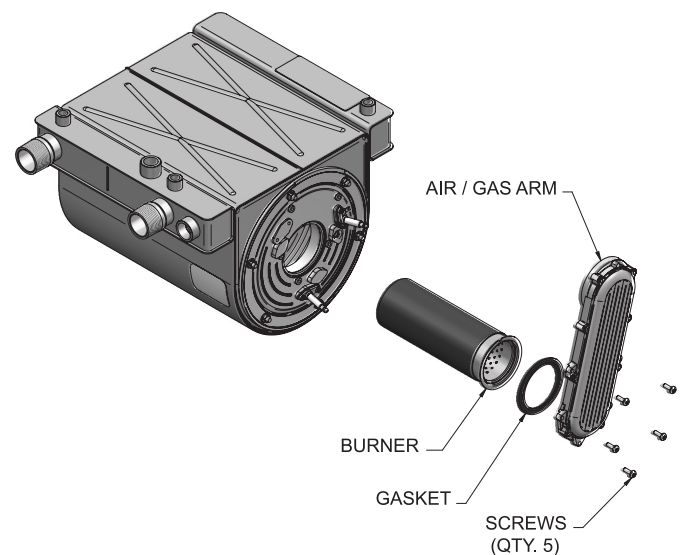

### Check flame signal

1. At high fire the flame signal shown on the display should be at least 10 microamps.
2. A lower flame signal may indicate a fouled or damaged flame sense electrode. If cleaning the flame sense electrode does not improve, ground wiring is in good condition, and ground continuity is satisfactory, replace the flame sense electrode.
3. See Section 3 - Troubleshooting in this manual for other procedures to deal with low flame signal.

### Review with owner

1. Emphasize the need to perform the maintenance schedule specified in this manual.
2. Remind the owner of the need to call a licensed contractor should the water heater or system exhibit any unusual behavior.
3. Remind the owner to follow the proper shutdown procedure and to schedule an annual start-up at the beginning of the next heating season.

## 2 Maintenance

### Cleaning heat exchanger

For recommended materials; including brush, appropriate extension(s), refractory cover, and detailed instructions see Table 2B - Heat Exchanger Cleaning Kits.

- Shut down water heater:
  - Follow the "To Turn Off Gas to Appliance" instructions for the water heater in Section 10 - Startup of the Installation and Operation Manual.
  - Do not drain the water heater unless it will be exposed to freezing temperatures. If using freeze prevention fluid in system, do not drain.
- Allow time for the water heater to cool to room temperature if it has been firing.
- Remove the nuts securing the heat exchanger access cover to the heat exchanger and set aside.
- Remove the heat exchanger access cover, burner, and gas/air arm assembly.

**WARNING** The water heater contains ceramic fiber materials. Use care when handling these materials per the instructions on page 3 of this manual. Failure to comply could result in severe personal injury.

- Remove the condensate hose from the heat exchanger end. Connect a field supplied 3/4" diameter hose to a drain pan. Using field supplied means, cover the refractory in the back of the combustion chamber of the heat exchanger.
- Use a vacuum cleaner to remove any accumulation on the water heater heating surfaces. Do not use any solvent.
- Brush the heat exchanger while dry using a nylon bristle brush. **Caution:** DO NOT use a metal brush. Re-vacuum the heat exchanger.
- Finish cleaning using a clean cloth dampened with warm water. Rinse out debris with a low pressure water supply.
- Allow the heat exchanger to thoroughly dry.
- Remove the field supplied rear refractory cover from the back of the combustion chamber of the heat exchanger and reassemble.
- Close isolation valves on piping to isolate water heater from system. Attach a hose to the water heater drain and flush water heater thoroughly with clean water by using purging valves to allow water to flow through the water make-up line to the water heater.

- Perform start-up and check-out procedures in the Check Flame and Combustion - Section 10 - Startup of the Installation and Operation Manual.
- Replace the access cover and restore water heater to operation.

**Table 2B Heat Exchanger Cleaning Kits**

Model	Kit Number	Part Number	Component Description
151 - 286	100157627	100140243	Rear Refractory Cover
		100162565*	Nylon 4" Wheel Brush*
		100162566	3mm Allen Wrench
		100162568	1/4" x 24" Drill Extension

**CAUTION** \* Do NOT use a metal brush. Only use the kit provided brush or an equivalent replacement nylon brush.

**Figure 2-3 Rope Gasket - Heat Exchanger Door**

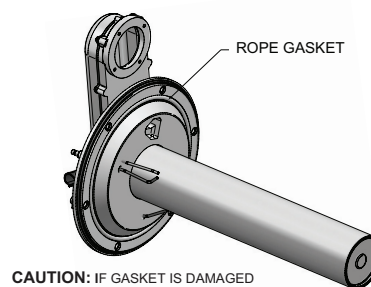

**CAUTION:** IF GASKET IS DAMAGED DO NOT REUSE, THE HEAT EXCHANGER DOOR MUST BE REPLACED.

**NOTICE** Rope gasket is intended for sealing combustion (see FIG. 2-3). If gasket is damaged DO NOT reuse, the heat exchanger door must be replaced. Consult factory for replacement heat exchanger door (kit 100173794 and 100173799).

### Check Delta T

- Check the Delta T using Table 2C as a reference.

**Table 2C Water Heater Pump Applications / Recommended Temperature Rise**

Water Heater Pump Applications						
Model	Pipe Size	Water Hardness	*Grundfos	Flow Rate (GPM)	Loss (FT/HD)	Temp. Rise
151	1-1/4"	5 to 12 gpg	*UP 43-100 SF	16	20	18°F
		12 to 15 gpg	TP 40-160	24	41	12°F
200/201	1-1/4"	5 to 12 gpg	*UP 43-100 SF	21	22	18°F
		12 to 15 gpg	TP 40-160	28	38	13°F
286	2"	5 to 12 gpg	*UP 43-100 SF	30	23	18°F
		12 to 15 gpg	TP 40-160	38	36	14°F

\*Denotes standard pump supplied with unit.

### Oiled bearing circulators

- The circulator shipped with the Armor water heater is water-lubricated. No oiling is required.
- Check other circulators in the system. Oil any circulators requiring oil, following circulator manufacturer's instructions. Over-oiling will damage the circulator.

### 3 Troubleshooting

**WARNING** Label all wires prior to disconnection when servicing controls. Wiring errors can cause improper and dangerous operation. Always disconnect power to the water heater before servicing. Failure to comply could result in severe personal injury, death, or substantial property damage.

**WARNING** Never jumper (bypass) any device except for momentary testing as outlined in the Troubleshooting chart. Severe personal injury, death, or substantial property damage can result.

#### Before troubleshooting:

1. Have the following items:
  - a. Voltmeter that can check 120 VAC, 24 VAC, and 12 VDC.
  - b. Continuity checker.
  - c. Contact thermometer.
2. Check for 120 VAC (minimum 102 VAC to maximum 132 VAC) to water heater.
3. Make sure thermostat is calling for heat and contacts (including appropriate zone controls) are closed. Check for 24 VAC between thermostat wire nuts and ground.
4. Make sure all external limit controls are installed and operating.

#### Check the following:

1. Wire connectors to control module are securely plugged in at the module and originating control.
2. Gas pressures:
  - Maximum: 14 inches w.c. (natural and LP) with no flow (lockup) or with water heater on
  - Minimum: 4 inches w.c. (natural), 8 inches w.c. (LP) with gas flowing (verify during water heater startup)

#### Check control module fuses

**NOTICE** ALWAYS check control module fuses before replacing control module or any major components (blower, etc.). If one of these fuses is blown, it can prevent the control module or other components from operating.

1. Turn OFF power to the water heater at the external line switch.
2. Remove top access cover.
3. Remove the control module cover.
4. Inspect fuses F1, F2 and F3, see FIG 3-1 below.

Figure 3-1 Control Module Fuses

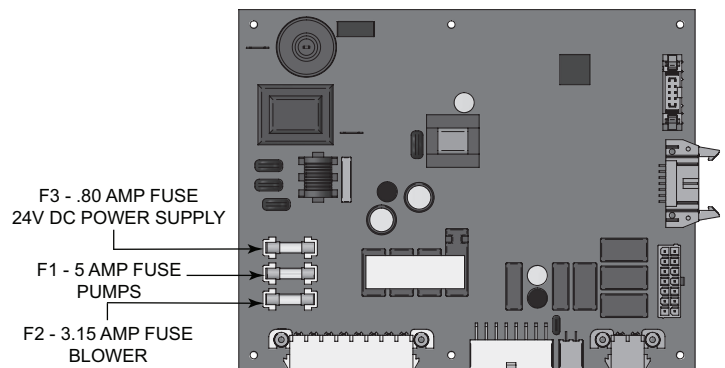

5. The water heater is shipped with three (3) spare fuses in a plastic bag attached to the control module cover.
6. If necessary, replace open fuse (F3 is .80 amps, F2 is 3.15 amps, and F1 is 5 amps).

**Note:** Fuses F1, F2 and F3 are all slow blow fuses.

**WARNING** Do not jumper fuse or replace with any fuse except as specified. Failure to comply could result in severe personal injury, death, or substantial property damage.

7. Install control module cover and top access cover after fuse inspection.
8. Restore power to the water heater at the external line switch and verify water heater operation (Section 10 - Start-up in the Armor Water Heater Installation and Operation Manual) after completing water heater service.

### 3 Troubleshooting

**Table 3A Troubleshooting Chart - No Display**

FAULT	CAUSE	CORRECTIVE ACTION
<b>No Display</b>	- No 120 VAC supplied to unit.	<ul style="list-style-type: none"> <li>• Check external line switch, fuse, or breaker.</li> <li>• Check position of ON/OFF switch. Turn switch to the ON position.</li> <li>• Check 120 VAC through the ON/OFF switch.</li> <li>• Check wiring harness connection between display board and main control board. Connect harness at both points.</li> </ul>
	- No voltage through the switch.	<ul style="list-style-type: none"> <li>• Replace switch.</li> </ul>
	- Bad display board.	<ul style="list-style-type: none"> <li>• Replace board.</li> </ul>
	- Bad main control board.	<ul style="list-style-type: none"> <li>• Replace the main control board.</li> </ul>
	- Blown fuse.	<ul style="list-style-type: none"> <li>• Replace fuse F3 on the main control board, see page 25 of this manual.</li> </ul>
<b>No Burner Operation</b>	- Main control board temperature set point satisfied.	<ul style="list-style-type: none"> <li>• Review temperature setting.</li> </ul>
	- Remote thermostat satisfied.	<ul style="list-style-type: none"> <li>• Review remote thermostat setting.</li> </ul>
	- Unit locked out on fault.	<ul style="list-style-type: none"> <li>• Consult display for specific fault. Refer to fault descriptions on pages 29 - 36 of this manual for corrective actions.</li> </ul>
<b>Unit Does Not Modulate Above 50%</b>	- Water heater controlled by BMS.	<ul style="list-style-type: none"> <li>• Check BMS parameter settings. Optional PC software required.</li> </ul>
	- Flue sensor open.	<ul style="list-style-type: none"> <li>• Verify that the flue sensor is located in the flue outlet.</li> </ul>
		<ul style="list-style-type: none"> <li>• Check wiring connections at the flue sensor.</li> <li>• Check the resistance of the flue sensor and compare to Table 3D on page 27 of this manual.</li> </ul>

### 3 Troubleshooting *(continued)*

#### Checking temperature sensors

The water heater temperature sensors (inlet water, outlet water, system water, and flue) are all resistance type devices. The following tables show the correct values for the sensors at various temperatures. Use an ohmmeter to read the resistance of the sensor at a known temperature. If the resistance of the sensor does not closely match its corresponding table, replace the sensor.

It is important to note that the flue and outlet water sensors have two temperature sensing devices in one housing. These devices are designated as S1a/S1b, outlet sensor and S3a/S3b, flue sensor. Please reference the wiring diagram in the Armor Water Heater Installation and Operation Manual for correct terminal location.

**Table 3B - Inlet System Sensor Resistance vs. Temperature**

Temperature °F	Resistance Ω	Temperature °F	Resistance Ω
50	18,780	158	1,990
68	12,263	176	1,458
86	8,194	194	1,084
104	5,592	212	817
122	3,893	--	--
140	2,760	--	--

**Table 3C - Outlet Water Sensor Resistance vs. Temperature**

S1a (Wire Color - R/BK and Y)				S1b (Wire Color - G and Y)			
Temperature	Resistance	Temperature	Resistance	Temperature	Resistance	Temperature	Resistance
50	19,553	158	2,004	50	40,030	158	3,478
68	12,690	176	1,464	68	25,030	176	2,492
86	8,406	194	1,084	86	16,090	194	1,816
104	5,715	212	816	104	10,610	212	1,344
122	3,958			122	7,166		
140	2,786			140	4,943		

**Table 3D - Flue Sensor Resistance vs. Temperature**

S3a (Wire Color - W/B and Y)				S3b (Wire Color - PR and Y)			
Temperature	Resistance	Temperature	Resistance	Temperature	Resistance	Temperature	Resistance
50	40,030	158	3,478	50	258,500	158	16,870
68	25,030	176	2,492	68	125,500	176	12,000
86	16,090	194	1,816	86	80,220	194	8,674
104	10,610	212	1,344	104	52,590	212	6,369
122	7,166			122	35,270		
140	4,943			140	24,160		

### 3 Troubleshooting

**Table 3E** Troubleshooting Chart - Noisy System

FAULT	CAUSE	CORRECTIVE ACTION
<b>Noisy Operation</b>	- Supply gas problem. Natural gas pressures should be between 4 inches w.c. and 14 inches w.c. LP gas pressures should be between 8 inches w.c. and 14 inches w.c.	<ul style="list-style-type: none"> <li>Refer to Section 7 - Gas Connections of the Armor Water Heater Installation and Operation Manual for detailed information concerning the gas supply.</li> </ul>
	- Gas/air mixture problem.	<ul style="list-style-type: none"> <li>Refer to the Gas Valve Adjustment Procedure on pages 38-39 of this manual for the proper gas valve setting. Verify that the vent/air intake lengths do not exceed the maximum listed in the General Venting section of the Armor Water Heater Installation and Operation Manual.</li> </ul>
	- Dirty/damaged burner.	<ul style="list-style-type: none"> <li>Refer to page 23 in this manual for the burner removal and inspection procedure. Clean or replace the burner as necessary.</li> </ul>
	- Low water flow through the heat exchanger.	<ul style="list-style-type: none"> <li>Refer to Section 6 - System Piping of the Armor Water Heater Installation and Operation Manual for typical flow rates.</li> </ul>
	- Air in the piping system.	<ul style="list-style-type: none"> <li>Properly purge all air from the piping system.</li> </ul>
	- Low system water pressure.	<ul style="list-style-type: none"> <li>Verify system pressure is a minimum of 12 PSI.</li> </ul>
<b>No Pump Operation</b>	- Blown fuse.	<ul style="list-style-type: none"> <li>Replace fuse F1 on the control board, see page 25 of this manual.</li> </ul>
	- Faulty pump.	<ul style="list-style-type: none"> <li>Replace pump.</li> </ul>
	- Faulty pump relay.	<ul style="list-style-type: none"> <li>Replace pump relay.</li> </ul>
	- Internal fault on control board.	<ul style="list-style-type: none"> <li>Replace main control board.</li> </ul>
<b>Relief Valve Opening</b>	- System pressure exceeds relief valve setting.	<ul style="list-style-type: none"> <li>Lower the system pressure below the 150 PSI rating of the supplied relief valve.</li> </ul>

# 3 Troubleshooting *(continued)*

**Table 3F Troubleshooting Chart - Fault Messages Displayed on Water Heater Interface**

FAULT	DESCRIPTION	CORRECTIVE ACTION
<b>Gas Pressure SW</b> (will require a manual reset once the condition has been corrected. Press the RESET button on the SMART SYSTEM display to reset.)	Either the manual reset low gas pressure switch or the manual reset high gas pressure switch tripped.	<ul style="list-style-type: none"> <li>• Reset the pressure switches.</li> <li>• Measure the supply gas pressure to determine cause of failure. Natural gas pressures should be between 4 - 14 inches w.c.</li> <li>• Refer to Section 7 - Gas Connections of the Armor Water Heater Installation and Operation Manual for detailed information concerning the gas supply.</li> <li>• Correct the supply gas pressure if necessary.</li> <li>• Check for a loose or misplaced jumper if pressure switches are not installed.</li> </ul>
<b>Flow Switch</b> (will require a manual reset once condition has been corrected. Press the RESET button on the SMART SYSTEM display to reset.)	The flow switch is not making.	<ul style="list-style-type: none"> <li>• Check water heater pump operation on a call for heat.</li> <li>• Check for closed valves or obstructions in the water heater piping.</li> <li>• Verify system is full of water and all air has been purged from the system.</li> <li>• Check for loose or misplaced jumpers if flow switch is not installed.</li> </ul>
	Blown fuse.	<ul style="list-style-type: none"> <li>• Replace fuse F2 on the control board, see page 25 of this manual.</li> </ul>
<b>Blocked Drain SW</b> (will require a manual reset once condition has been corrected. Press the RESET button on the SMART SYSTEM display to reset.)	The blocked drain switch has detected excessive condensate build up inside the unit.	<ul style="list-style-type: none"> <li>• Check condensate tube from unit to floor drain for proper installation and obstructions.</li> <li>• Inspect condensate trap for blockage. Clean if necessary.</li> <li>• Check for loose wiring connection at wire harness plug.</li> <li>• Bad blocked drain switch. Replace switch.</li> </ul>
<b>APS / HEX Temp Sw Open</b> (will require a manual reset once the condition has been corrected. Press the RESET button on the SMART SYSTEM display to reset.)	<p>Either the air pressure switch contacts are open, the O-temp heat exchanger switch has opened, or the burner door temperature switch has opened.</p> <div style="border: 1px solid black; padding: 2px; display: inline-block;"> <b>WARNING</b> </div> If the burner door temperature switch trips, the burner door and the burner door temperature switch will be extremely HOT. Allow the unit to cool before touching. Failure to follow this warning could result in severe personal injury, death, or substantial property damage.	<p style="text-align: center;"><b>APS:</b></p> <ul style="list-style-type: none"> <li>• Check the wiring connections to switch. Wires should be connected to the common and normally closed terminals.</li> <li>• Air intake lengths exceed the maximum allowed lengths. Refer to Section 3 - General Venting of the Armor Installation and Operation Manual for proper lengths.</li> <li>• Check for obstruction or blockage in the air intake pipes or at terminations.</li> <li>• Check reference hoses connected to the air pressure switch for blockage or obstruction.</li> <li>• Inspect the burner. Reference page 23 of this manual for removal and cleaning procedures. Replace if necessary.</li> <li>• Inspect the heat exchanger. Reference page 24 of this manual for removal and cleaning procedures. Replace if necessary.</li> <li>• Faulty air pressure switch. Replace switch.</li> </ul> <p style="text-align: center;"><b>O-TEMP HEX SWITCH (Applies to the 286 Model Only):</b></p> <ul style="list-style-type: none"> <li>• Inspect the back of the inner combustion chamber at burner level for refractory breakdown / missing. Replace heat exchanger if refractory is broken and unit has fired.</li> <li>• Check continuity across two contacts. Wires should be connected at both poles of the normally closed switch.</li> <li>• Faulty O-Temp HEX Switch. Replace switch.</li> </ul> <p style="text-align: center;"><b>BURNER DOOR TEMPERATURE SWITCH (Applies to the 286 Model Only):</b></p> <ul style="list-style-type: none"> <li>• The underlying cause of the fault must be identified and resolved by a qualified service technician before resetting the burner door temperature switch.</li> <li>• Check continuity across two contacts. Wires should be connected at both poles of the normally closed switch.</li> <li>• Faulty burner door temperature switch. Replace burner door temperature switch.</li> </ul>

### 3 Troubleshooting

Table 3F (continued from previous page) Troubleshooting Chart - Fault Messages Displayed on Water Heater Interface

FAULT	DESCRIPTION	CORRECTIVE ACTION
<p><b>Anti-cycling</b></p>	<p>The main control board has received a call for heat too quickly after the previous call for heat has ended.</p>	<ul style="list-style-type: none"> <li>• The control board will release the call for heat after a set time period.</li> <li>• The control board will release the call for heat if the outlet temperature drops too quickly.</li> </ul>
<p><b>Flame Fail Ign</b> (will require a manual reset once the condition has been corrected. Press the RESET button on the SMART SYSTEM display to reset.)</p>	<p>The unit has failed to prove main burner ignition after four (4) attempts.</p>	<ul style="list-style-type: none"> <li>• Check wiring harness connection at the gas valve and at the main control board.</li> <li>• Inspect spark electrode and associated wiring for damage and connection. Reference page 23 of this manual for removal and cleaning procedures. Replace if necessary.</li> <li>• Check for proper electrical grounding of the unit.</li> <li>• Check incoming supply gas pressure. Natural gas pressures should be between 4 - 14 inches w.c. and LP gas pressures should be between 8 - 14 inches w.c. Refer to Section 7 - Gas Connections of the Armor Water Heater Installation and Operation Manual for detailed information concerning the gas supply.</li> <li>• Verify that the plastic hose from the gas valve to the air inlet is connected and is not damaged.</li> <li>• Verify that the vent/air intake pipes are correctly installed and that there are no obstructions.</li> <li>• Check for 24 VAC to the gas valve at the 2-pin connection on the side of the main control board during the ignition attempt. If no voltage is present, replace the main control board.</li> <li>• If 24 VAC is present at the main control board, check the wiring between the main control board and the gas valve. Replace the wiring if necessary.</li> <li>• If 24 VAC is present, check the outlet of the valve to ensure the valve is flowing gas. With a manometer connected to the outlet tap of the gas valve, when the unit is in the prepurge period, there should be a negative pressure present. When the valve is energized a change in pressure should occur. If the pressure change does not occur, the gas valve is not opening. Replace the gas valve.</li> <li>• Inspect flame sensor and associated wiring. Reference page 23 of this manual for removal and cleaning procedures. Replace if necessary.</li> <li>• Inspect the burner. Reference page 23 of this manual for removal and cleaning procedures. Replace if necessary.</li> <li>• Replace the main control board.</li> </ul>

### 3 Troubleshooting

**Table 3F** (continued from previous page) *Troubleshooting Chart - Fault Messages Displayed on Water Heater Interface*

FAULT	DESCRIPTION	CORRECTIVE ACTION
<p><b>Flame Sequence</b> (will require a manual reset once the condition has been corrected. Press the RESET button on the SMART SYSTEM display to reset.)</p>	<p>The flame detector circuit is seeing a flame signal while no flame is present.</p>	<ul style="list-style-type: none"> <li>• Check supply voltage for proper polarity.</li> <li>• Check external wiring for voltage feedback.</li> <li>• Check the flame rod and make sure it is clean.</li> <li>• Check the internal wiring for bad connections.</li> <li>• Replace main control board.</li> </ul>
<p><b>Auto Reset High Limit</b></p>	<p>The outlet water temperature has exceeded the setting of the automatic reset high limit.</p>	<ul style="list-style-type: none"> <li>• Verify that the system is full of water and that all air has been properly purged from the system.</li> <li>• Verify that the water heater is piped properly into the heating system. Refer to Section 6 - Hydronic Piping of the Armor Installation and Operation Manual for the proper piping methods for the Armor water heater.</li> <li>• Check 120 vac to water heater pump motor on a call for heat. If voltage is not present, check wiring back to the main control board.</li> <li>• Replace the main control board if necessary.</li> <li>• If 120 vac is present on a call for heat and the water heater pump is not operating, replace the pump.</li> <li>• If the system pump is a variable speed pump, ensure that the system flow is not less than the water heater flow.</li> <li>• If operating on something other than an outlet sensor, check temperature setting of the main control board.</li> <li>• If the manual reset high limit has tripped, check setting of the device.</li> <li>• Check resistance of water sensors and compare to Table B on page 27 of this manual. Replace sensor if necessary.</li> <li>• Replace high limit.</li> </ul>
<p><b>Manual Reset High Limit</b> (will require a manual reset once the condition has been corrected. Press the RESET button on the SMART SYSTEM display to reset.)</p>	<p>The outlet water temperature has exceeded the fixed setting of the manual reset high limit.</p>	<ul style="list-style-type: none"> <li>• Verify that the system is full of water and that all air has been properly purged from the system.</li> <li>• Verify that the water heater is piped properly into the heating system. Refer to Section 6 - System Piping of the Armor Water Heater Installation and Operation Manual for the proper piping methods for the Armor water heater.</li> <li>• Check 120 VAC to water heater pump motor on a call for heat. If voltage is not present, check wiring back to the main control board.</li> <li>• Replace the main control board if necessary.</li> <li>• If 120 VAC is present on a call for heat and the water heater pump is not operating, replace the pump.</li> <li>• If the manual reset high limit has tripped, check setting of the device.</li> <li>• Check resistance of water sensors and compare to Table 3C on page 27 of this manual. Replace sensor if necessary.</li> <li>• Replace high limit.</li> </ul>

### 3 Troubleshooting *(continued)*

**Table 3F** (continued from previous page) *Troubleshooting Chart - Fault Messages Displayed on Water Heater Interface*

FAULT	DESCRIPTION	CORRECTIVE ACTION
<p><b>Fan Low</b> <b>OR</b> <b>Fan Speed Low</b> (will require a manual reset once the condition has been corrected. Press the RESET button on the SMART SYSTEM display to reset.)</p>	<p>The actual fan RPM is 30% lower than what is being called for.</p>	<ul style="list-style-type: none"> <li>• Vent/air intake lengths exceed the maximum allowed lengths. Refer to Section 3 - General Venting of the Armor Water Heater Installation and Operation Manual for proper lengths.</li> <li>• Check for obstruction or blockage in the vent/air intake pipes or at terminations.</li> <li>• Check the wiring connections at the fan and at the main control board.</li> <li>• Replace the fan.</li> <li>• Replace the main control board.</li> </ul>
	<p>Blown fuse.</p>	<ul style="list-style-type: none"> <li>• Replace fuse F4 on the control board, see page 25 of this manual.</li> </ul>
<p><b>Fan High</b> <b>OR</b> <b>Fan Speed High</b> (will require a manual reset once the condition has been corrected. Press the RESET button on the SMART SYSTEM display to reset.)</p>	<p>The actual fan RPM is 30% higher than what is being called for.</p>	<ul style="list-style-type: none"> <li>• Vent/air intake lengths exceed the maximum allowed lengths. Refer to Section 3 - General Venting of the Armor Water Heater Installation and Operation Manual for proper lengths.</li> <li>• Check for obstruction or blockage in the vent/air intake pipes or at terminations.</li> <li>• Check the wiring connections at the fan and at the main control board.</li> <li>• Replace the fan.</li> <li>• Replace the main control board.</li> </ul>
<p><b>Sensor Open</b> (will require a manual reset once the condition has been corrected. Press the RESET button on the SMART SYSTEM display to reset.)</p>	<p>Either the inlet water or outlet water temperature sensor has been disconnected.</p>	<ul style="list-style-type: none"> <li>• Check the sensors and their associated wiring. Repair or replace the sensor or wiring if damaged.</li> <li>• Measure the resistance of the sensors and compare the resistance to the tables on page 27 of this manual.</li> <li>• Replace the sensor if necessary.</li> </ul>

### 3 Troubleshooting

**Table 3F** (continued from previous page) *Troubleshooting Chart - Fault Messages Displayed on Water Heater Interface*

FAULT	DESCRIPTION	CORRECTIVE ACTION
<b>Sensor Shorted</b> (will require a manual reset once the condition has been corrected. Press the RESET button on the SMART SYSTEM display to reset.)	Either the inlet water or outlet water temperature sensor has been shorted.	<ul style="list-style-type: none"> <li>• Check the sensors and their associated wiring. Repair or replace the sensor or wiring if damaged.</li> <li>• Measure the resistance of the sensors and compare the resistance to the tables on page 27 of this manual.</li> <li>• Replace the sensor if necessary.</li> </ul>
<b>Louver Proving</b> (will require a manual reset once the condition has been corrected. Press the RESET button on the SMART SYSTEM display to reset.)	An optional remote proving switch is not making.	<ul style="list-style-type: none"> <li>• Check function of remote devices.</li> <li>• Check for loose or misplaced jumper if auxiliary proving switch is not installed.</li> </ul>
<b>Flue Temp High</b>	The stack temperature has exceeded the set parameters for the water heater.	<ul style="list-style-type: none"> <li>• Inspect the heat exchanger. Reference page 24 of this manual for the procedure on how to clean the flue side of the heat exchanger.</li> <li>• Inspect the flue sensor and associated wiring. Measure the resistance of the flue sensor and compare to Table 3D on page 27 of this manual. Replace the sensor if necessary.</li> <li>• Verify that the vent/air intake pipes are properly installed and that there are no obstructions.</li> <li>• Replace the main control board.</li> </ul>
	Scaling has reduced water flow.	<ul style="list-style-type: none"> <li>• Deliming may be required.</li> </ul>
<b>Delta T High</b>	The temperature rise across the heat exchanger has exceeded the set parameters for the water heater.	<ul style="list-style-type: none"> <li>• Verify that the system is full of water and that all air has been properly purged from the system.</li> <li>• Verify that the water heater is piped properly into the heating system. Refer to Section 6 - System Piping of the Armor Water Heater Installation and Operation Manual for the proper piping methods for the Armor water heater.</li> <li>• Check for 120 VAC to the water heater pump motor on a call for heat. If voltage is not present, check the wiring back to the main control board. Replace the main control board if necessary.</li> <li>• If 120 VAC is present on a call for heat and the water heater pump is not operating, replace the pump.</li> <li>• Verify that the water heater pump is set to the proper speed or that the pump is the proper size. Reference Section 6 - System Piping of the Armor Water Heater Installation and Operation Manual for water heater pump specifications.</li> </ul>

### 3 Troubleshooting *(continued)*

**Table 3F** (continued from previous page) *Troubleshooting Chart - Fault Messages Displayed on Water Heater Interface*

FAULT	DESCRIPTION	CORRECTIVE ACTION
<b>Outlet Temp High</b>	Outlet water temperature has exceeded the maximum outlet water temperature.	<ul style="list-style-type: none"> <li>• Verify that the system is full of water and that all air has been properly purged from the system.</li> <li>• Verify that the water heater is piped properly into the heating system. Refer to Section 6 - System Piping of the Armor Water Heater Installation and Operation Manual for the proper piping methods for the Armor water heater.</li> <li>• Check for 120 VAC to the water heater pump motor on a call for heat. If voltage is not present, check wiring back to the main control board. Replace the main control board if necessary.</li> <li>• If 120 VAC is present on a call for heat and the water heater pump is not operating, replace the pump.</li> <li>• Replace the main control board.</li> </ul>
<b>Rem Ctrl Flt</b>	External control is cycling too often.	<ul style="list-style-type: none"> <li>• Check set point of the external control.</li> <li>• Check the wiring between the external control and the unit.</li> <li>• Replace the control.</li> </ul>
<b>Service Blk</b>	While the unit is in Service Mode, the outlet temperature has exceeded 185°F.	<ul style="list-style-type: none"> <li>• Establish a heating load to remove the heat from the water heater loop.</li> <li>• Verify that the system is full of water and that all air has been properly purged from the system.</li> <li>• Verify that the water heater is piped properly into the heating system. Refer to Section 6 - System Piping of the Armor Water Heater Installation and Operation Manual for the proper piping methods for the Armor water heater.</li> <li>• Check 120 VAC to the water heater pump motor on a call for heat. If voltage is not present, check the wiring back to the main control board. Replace the main control board if necessary.</li> <li>• If 120 VAC is present on a call for heat and the water heater pump is not operating, replace the pump.</li> <li>• Verify that the water heater pump is set to the proper speed or that the water heater pump is the proper size. Reference Section 6 - System Piping of the Armor Water Heater Installation and Operation Manual for water heater pump specifications.</li> </ul>

### 3 Troubleshooting

*Table 3F (continued from previous page) Troubleshooting Chart - Fault Messages Displayed on Water Heater Interface*

FAULT	DESCRIPTION	CORRECTIVE ACTION
<b>Low 24 VAC</b>	120 VAC input to the main control board has dropped below 80 VAC.	<ul style="list-style-type: none"> <li>• Check 120 VAC supply to the transformer.</li> <li>• Check wiring connections at the low voltage terminal strip.</li> <li>• Check the wire size/length to remote devices.</li> <li>• Replace the transformer.</li> </ul>
<b>Watch Dog Error</b>	The main control board has detected an internal fault.	<ul style="list-style-type: none"> <li>• Replace the main control board.</li> </ul>
<b>Write EEPROM</b>	The main control board has detected an internal fault.	<ul style="list-style-type: none"> <li>• Replace the main control board.</li> </ul>
<b>CRC Parameters</b>	The main control board has detected an internal fault.	<ul style="list-style-type: none"> <li>• Replace the main control board.</li> </ul>
<b>No Error Stored</b>	The main control board has detected an internal fault.	<ul style="list-style-type: none"> <li>• Replace the main control board.</li> </ul>
<b>Fatal Error Parameters</b>	The main control board has detected an internal fault.	<ul style="list-style-type: none"> <li>• Restore the default parameters.</li> <li>• Replace the main control board.</li> <li>• Replace the display board.</li> </ul>

### 3 Troubleshooting *(continued)*

#### Combustion Analysis Procedure

1. Turn the main power off to the water heater by placing the "On/Off" switch in the OFF position.
2. Remove the flue temperature sensor from the flue pipe connection. **Note:** Combustion measurements will be made at this point.
3. Turn the main power on to the water heater by placing the "On/Off" switch in the ON position.
4. Place the water heater into the active position by pressing the RIGHT SELECT [ON] key (see page 5).
5. Locate the pinhole button below the RESET button on the display board (see page 5). Insert a thin wire (such as a paper clip) into the hole and press the button once and hold for 5 seconds to place the water heater into Service Mode. In Service Mode the water heater will fire at ignition speed and will then modulate up to full fire.
6. Insert the probe from a combustion analyzer into the hole left by the removal of the flue temperature sensor.
7. Once the water heater has modulated up to full fire, measure the combustion. The values should be in the range listed in Table 3G above. The CO levels should be less than 150 ppm for a properly installed unit.

If the combustion is not within the specified range, reference the chart below for possible causes and corrective actions.

**Table 3G Flue Products**

Natural Gas		Propane	
CO <sub>2</sub>	O <sub>2</sub>	CO <sub>2</sub>	O <sub>2</sub>
8.0% - 10%	3.0% - 6.5%	9.0% - 11%	4.1% - 6.9%

8. Once the combustion analysis is complete, test the safety shutoff device by turning the manual shutoff valve to the OFF position and ensuring that the water heater shuts down and registers an alarm. Open the manual shutoff valve, reset the control, and return to Service Mode.
9. Turn the main power off to the water heater and replace the flue temperature sensor into the flue pipe connection.
10. Place the water heater back into normal operation.



You must replace the flue gas temperature sensor to prevent flue gas spillage into the room. Failure to comply could result in severe personal injury, death, or substantial property damage.

**Table 3H Troubleshooting Chart - Combustion Levels**

POSSIBLE CAUSE	CORRECTIVE ACTION
Vent/Air Intake Length or Obstruction	<ul style="list-style-type: none"> <li>• Refer to Section 3 - General Venting of the Armor Water Heater Installation and Operation Manual for the proper venting and air intake methods for the Armor water heater.</li> <li>• Check for obstructions at the vent/air intake terminals.</li> </ul>
Gas Supply Pressure	<ul style="list-style-type: none"> <li>• Refer to Section 7 - Gas Connections of the Armor Water Heater Installation and Operation Manual for the proper gas supply for the Armor water heater.</li> </ul>
Dirty/Damaged Burner	<ul style="list-style-type: none"> <li>• Refer to page 23 of this manual for burner removal and cleaning procedures.</li> <li>• Replace burner if necessary.</li> </ul>
Gas Valve Adjustment	<ul style="list-style-type: none"> <li>• Refer to pages 38-39 of this manual for the gas valve adjustment procedure.</li> </ul>

## 3 Troubleshooting

### Gas valve adjustment procedure

If adjustment of the gas valve is deemed necessary, use the following procedures: (**Note:** The procedures in this section are model specific.)

#### All models

Locate the throttle adjustment screw on the side of the venturi valve (FIG. 3-2). Using a screwdriver, turn the screw a 1/4 turn **clockwise** to decrease CO<sub>2</sub> levels or a 1/4 turn **counterclockwise** to increase CO<sub>2</sub> levels. After performing one adjustment on the valve, follow the Combustion Analysis Procedure on page 37 of this manual to measure the combustion.

If combustion is still not within the specified range, repeat the procedure. This procedure **SHOULD NOT** be performed more than four (4) times. If after four (4) adjustments and the combustion is still not within the specified range, revisit the possible causes in Table 3H on page 37 or replace the gas valve.

**Figure 3-2** Gas Valve Adjustment

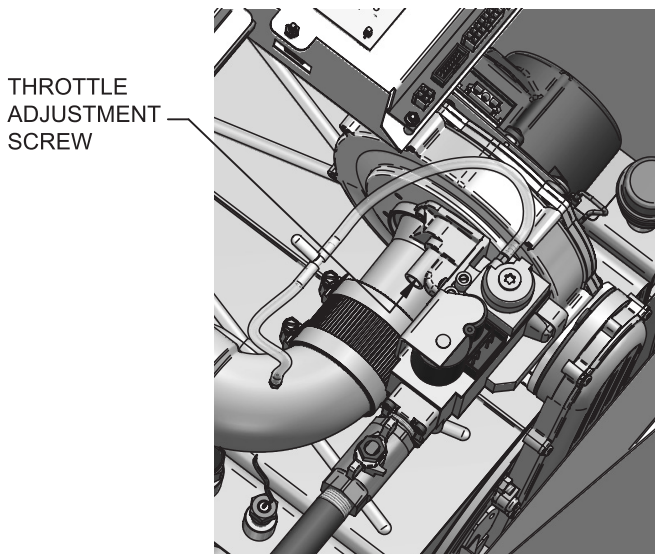





**Revision Notes:** Revision A (ECO #C06238) initial release.

*Revision B (ECO #C08817) reflects changes made to the parameter table, parameter descriptions, updates to the troubleshooting chart, the addition of the O-temp HEX switch, and the addition of the rope gasket notice on page 23 (ECR R03940).*

*Revision C (ECO #C09197) reflects updates made to the SMART SYSTEM control (ECR #R04523).*

*Revision D (ECO #C10143) reflects the removal of the "GV/RELAY FAIL" FAULT (ECR #R05239) and updates made to the ignition timing information.*

*Revision E (ECO #C12382) reflects the addition of the CSA Low Lead Content logo.*

*Revision F (ECO #C14411) reflects condensate trap changes (R6594).*

*Revision G (ECO #C15251) reflects the addition of the burner door temperature switch (R6322) on pages 6 and 28.*

*Revision H (ECO #C16894) reflects the removal of temperature and pressure gauge information on page 19.*

*Revision J (PCP# 300002544 / CN# 50002701) reflects changes made to Table 1D on page 12, as well as the addition of the Ramp Delay and Ramp Settings sections on pages 16. Additional edits were made to the BMS Thermostat Input on page 17.*

*Revision K (PCP #3000010923 / CN #500010523) reflects an update to Table 2A on page 20.*

*Revision L (PCP #3000029323 / CN #500018870) reflects a change from "minimum" to "typical" flow rate on page 28.*

*Revision M (PCP #3000030779 / CN #5000020179) reflects an update to Table 2A.*

*Revision N(PCP#3000049033 / CN #500036140) Adding 201 Model*

*Revision P (PCP #3000056106 / CN #500042631) reflects the removal of discontinued models.*