

On-Demand Water Heater Installation Manual and Owner's Guide



ANSI Z21.10.3 • CSA 4.3



Gas Tankless Water Heater™

*Suitable for potable water heating only
Suitable for recirculation with a crossover valve.
Not suitable to be used with a dedicated return line.*

FEATURING

- ENDLESS HOT WATER
- ON-DEMAND USAGE
- COMPACT, SPACE SAVING
- ENERGY CONSERVATION
- COMPUTERIZED SAFETY
- ELECTRONIC IGNITION
- Complies with SCAQMD Rule 1146.2 for natural gas Low NOx Emissions of 14 ng/J or 20-ppm
- CONCENTRIC VENT
- FIELD GAS CONVERSION
- X3™ TECHNOLOGY

Models

310CX3

510CX3

Series 110



WARNING

If the information in these instructions is not followed exactly, a fire or explosion may result causing property damage, personal injury or death.

- Do not store or use gasoline or other flammable vapors and liquids in the vicinity of this or any other appliance.
- WHAT TO DO IF YOU SMELL GAS
 - Do not try to light any appliance.
 - Do not touch any electric switch; do not use any phone in your building.
 - Immediately call your gas supplier from a neighbor's phone. Follow the gas supplier's instructions.
 - If you cannot reach your gas supplier, call the fire department.
- Installation and service must be performed by a qualified installer, service agency or the gas supplier.

If you have any questions, please
call or write to:

In the United States

500 Tennessee Waltz Parkway

Ashland City, TN 37015

Toll Free: 1-877-737-2840

Keep this manual near the water heater for future reference whenever maintenance, adjustment, or service is required.

CONTENTS

Installation Manual

SPECIFICATIONS	4
INTRODUCTION	5
SAFETY GUIDELINES	6
SAFETY DEFINITION.....	6
GENERAL.....	6
INSTALLATION	7
GENERAL.....	7
CLEARANCES	9
INCLUDED ACCESSORIES.....	9
OPTIONAL ITEMS.....	9
WARNING FOR INSTALLATIONS.....	11
HIGH-ALTITUDE INSTALLATIONS	12
VENTING INSTRUCTIONS	13
Vent length and no. of elbows	14
DIP switch settings for vent length.....	14
Venting illustrations.....	15
Vent termination clearances	16
Clearances for sidewall terminations	17
Clearances for rooftop terminations	17
GAS SUPPLY AND GAS PIPE SIZING	18
General	18
Gas connections	18
Natural gas supply piping	19
Propane (LP) supply piping.....	19
WATER CONNECTIONS	20
Pressure relief valve	20
X3™ Scale prevention technology	21
ELECTRICAL CONNECTIONS	22
TEMPERATURE REMOTE CONTROLLER	23
Optional item.....	23
Installation	23
APPLICATIONS	25
INITIAL OPERATION	26

Owner's Guide

OPERATING SAFETY	28
NORMAL OPERATION	30
BUILT-IN CONTROLLER	
AND REMOTE CONTROLLER	30
GENERAL.....	30
TEMPERATURE SETTING	31
Set temperature	31
TEMPERATURE TABLE OF CONTROLLER	31
ADDITIONAL FEATURES.....	32
Information mode	32
Unit conversion mode	32
TEMPERATURE SETTINGS ON THE PCB	33
FLOW	33
FREEZE PROTECTION SYSTEM	34
MAINTENANCE AND SERVICE	35
INLET WATER FILTER CLEANING.....	35
MEASURING INLET GAS PRESSURE.....	36
UNIT DRAINING & POWER OUTAGE (FREEZE PROTECTION)	37
TROUBLESHOOTING	38
GENERAL.....	38
ERROR CODES	39
General	39
Fault Analysis of Error Codes.....	40
COMPONENTS DIAGRAM	42
PARTS LIST	46
OUTPUT TEMPERATURE CHART	48

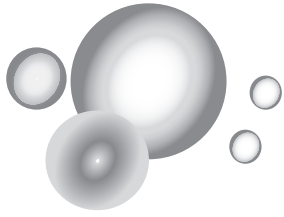

Installation Manual

CONGRATULATIONS

Congratulations and thank you for choosing our tankless water heater. Before use, we recommend that you read through this installation manual carefully. Keep this manual for future reference.

If you need an additional manual, contact the manufacturer or your local distributor. You may also download a manual from our web page. When you call, please tell us the product name and the serial number of your unit written on the rating plate of the water heater.

SPECIFICATIONS

Model			310CX3 (AT-K5U-CV-SCM)	510CX3 (AT-D3U-CV-SCM)
Natural Gas Input (Operating Range)	BTU/h		Min.: 15,000 Max.: 190,000	Min.: 15,000 Max.: 199,000
Gas Connection			3/4" NPT	
Water Connections			3/4" NPT	
Water Pressure*	psi (MPa)		15 - 150 (0.1 - 1)	
Natural gas Inlet Pressure	" W.C. (kPa)		Min. 4.0 (1.00) Max. 10.5 (2.61)	
Weight	lbs. (kg)		51 (23)	
Dimensions	inch		H 20.5 x W 13.7 x D 10.5	
	mm		H 520 x W 350 x D 266	
Ignition			Electric Ignition	
Electric Consumption	Supply	VAC / Hz	120/60	
	Operation	W / A	77/0.91	79/0.94
	Standby	W / A	2/0.05	2/0.05
	Freeze- Protection	W / A	113/0.94	114/0.95

*Maximum flow may need water pressure equal to or above 40 psi.

NOTE:

- Check the rating plate to ensure this product matches your specifications.
- **The manufacturer reserves the right to discontinue, or change at any time, specifications or designs without notice and without incurring obligations.**

NOTICE

The 310CX3/510CX3 models do not have Easy-Link or Multi-Unit capability.

INTRODUCTION

- This manual provides information necessary for the installation, operation, and maintenance of the water heater.
- The model description is listed on the rating plate which is attached to the side panel of the water heater.
- Please read all installation instructions completely before installing this product.
- If you have any problems or questions regarding this equipment, consult the manufacturer or its local representative.
- This appliance is an on-demand, tankless water heater. It is designed to efficiently supply endless hot water for your needs.
- The 310CX3, and 510CX3 models are only to be installed indoors with concentric venting.
- The principle behind tankless water heaters is simple:

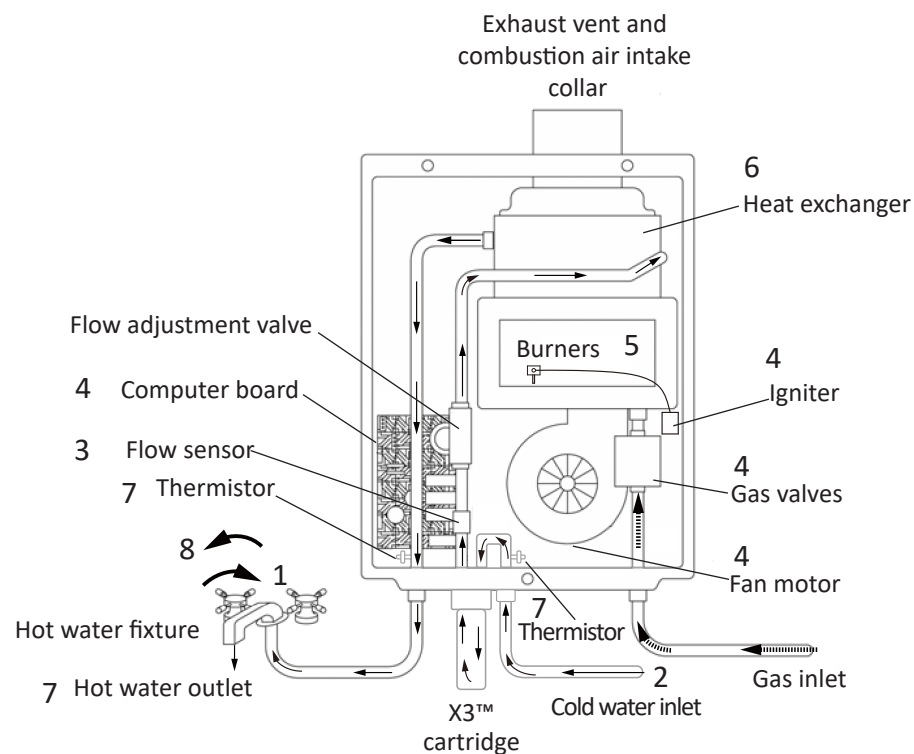

*This diagram illustrates tankless water heater design concepts only and does not accurately represent the water heater's physical description.

1. A hot water fixture is turned on.
2. Water flows through the X3™ Scale Prevention Technology cartridge.
3. The water flow sensor detects the water flow.
4. The computer initiates the fan motor and gas valve to let gas flow through the heater and sends a signal to the igniter to create an ignition spark.
5. The gas ignites and flames appear within the burner chamber.
6. Water is heated as it flows through the heat exchanger.
7. Using thermistors to measure temperatures throughout the water heater, the computer modulates the gas and water valves to ensure proper output water temperature and hot water outflows.
8. When the fixture is turned off, the unit shuts down.

SAFETY GUIDELINES

SAFETY DEFINITION



Indicates an imminently hazardous situation which, if not avoided, will result in death or serious injury.



Indicates an imminently hazardous situation which, if not avoided, could result in death or serious injury.



Indicates an imminently hazardous situation which, if not avoided, could result in minor or moderate injury.

NOTICE

Indicates information considered important but not hazard related.

GENERAL

1. Follow all local codes, or in the absence of local codes, follow the current edition of the National Fuel Gas Code: ANSI Z223.1/NFPA 54.
2. Properly ground the unit in accordance with all local codes or in the absence of local codes, with the current edition of the National Electrical Code: ANSI/NFPA 70.
3. Carefully plan where you intend to install the water heater. Please ensure:
 - Your water heater will have enough combustion air and proper ventilation.
 - Locate your heater where water leakage will not damage surrounding areas. (Please refer to page 8.)
4. Check the rating plate for the correct **GAS TYPE, GAS PRESSURE, WATER PRESSURE and ELECTRIC RATING**. If this unit does not match your requirements, **do not install and consult with the manufacturer**. The water heater is configured only for use with Natural Gas at the factory. If the appliance is used with propane gas, conversion to propane gas with an included conversion kit (**LP Conversion Kit: 100357126**) is required. The conversion must be done by a qualified service agent or a gas utility service person in accordance with this instruction and all codes and requirements of the authority having jurisdiction. Failure to follow instructions could result in property damage, serious personal injury, or death. The agent performing this work assumes responsibility for this conversion. (Refer to the gas conversion leaflet.)
5. If any problem should occur, turn off all hot water fixtures and turn off the gas. Then call a trained technician, the gas company, or the manufacturer.



WARNING

- Water temperatures over 125 °F (52 °C) can cause severe burns instantly or death from scalding. The water temperature is set at 120 °F (50 °C) from the factory to minimize any scalding risk. Before bathing or showering always check the water temperature.
- To reduce the risk of scalding, install Thermostatic Mixing Valves (temperature limiting valves) at each point of use.
- Do not store or use gasoline or other flammables, vapors, or liquids in the vicinity of this appliance.
- Do not reverse the water and/or gas connections as this will damage the gas valves and can cause severe injury or death. Follow the diagram on page 20 when installing your water heater
- Failure to observe these warnings could result in severe personal injury or death.



- The conversion to propane must be done by a qualified service agent or a gas utility serviceman in accordance with this instruction and all codes and requirements of the authority having jurisdiction. Failure to follow instructions could result in serious injury or property damage. The qualified agent performing this work assumes responsibility for this conversion.
- Do not use this appliance if any part has been in contact with or been immersed in water. Immediately call a qualified installer or service agency to replace a flooded water heater. Do not attempt to repair the unit. It must be replaced.
- Should overheating occur or the gas supply fails to shut off, turn off the manual gas control valve to the appliance.
- Do not disconnect the electrical supply if the ambient temperature will drop below freezing unless the water has been drained from the water heater. The Freeze Protection System only works if the unit has electrical power. The warranty will not be covered if the heat exchanger is damaged due to freezing. Refer to the sections on Freeze Protection System on page 34 and on Unit Draining & Power Outage (Freeze Protection) on page 37 for more information.
- Failure to observe this warning could result in severe personal injury or death.

INSTALLATION

GENERAL

1. Follow all local codes, or in the absence of local codes, follow the current edition of the National Fuel Gas Code: ANSI Z223.1/NFPA 54.
2. All gas water heaters require careful and correct installation to ensure safe and efficient operation. This manual must be followed exactly. Read the "Safety Guidelines" section.
3. The manifold gas pressure is preset at the factory. It is computer controlled and should not need adjustment.
4. Maintain proper space for servicing. Install the unit so that it can be connected or removed easily. Refer to the "Clearances" section on page 9 for proper clearances.
5. Electrical service to the water heater requires a means of disconnection. This will allow power to the water heater to be shut off for servicing and safety purposes.
6. Install the water heater so it is level (left-to-right & front-to-back) and plumb (vertically).
7. Do not install the unit where the exhaust vent is pointing into any opening in a building or where the noise may disturb your neighbors. Make sure the vent termination meets the required distance from any doorway or opening to prevent exhaust from entering a building. (Refer to pages 11, 16, and 17.) Check local code requirements prior to installation.
8. Carefully plan the installation location of the heater and vent terminations. Contaminants such as aerosols, lint, and fine powders (including flour) can clog the air intake. This could reduce the operation of the fan, causing improper combustion and reduced life of the water heater. Ensure that the area around the heater, vent termination, and air intake is free of dust, debris, other contaminants. Regular maintenance is recommended in environments with these items in the air.
9. The venting system shall be installed in accordance with the water heater manufacturer's instructions and vent system manufacturer's instructions.
10. A condensate collector and trap ([100266140](#) & [100266139](#)) are required to be installed in the venting system when there is more than 8 ft (2.4 m) of equivalent vent length, not including the sidewall termination. 87° elbow is equivalent to 5 ft (1.5 m) of vent length. The condensate collector must be installed on the heater's flue. The condensate trap and collector are required on all vertical installations. See the illustrations on page 15.
11. Only install the water heater in a heated area where below freezing temperatures cannot occur.
12. When an existing Category I appliance is removed or replaced, the original venting system may no longer be sized to properly vent the attached water heater. An improperly sized venting system may cause formation of condensate, leakage, and spillage and so on.



WARNING

- Installation and service must be performed by a qualified installer (for example, a licensed plumber or gas fitter). Otherwise, the warranty will be void.
- The installer (licensed professional) is responsible for the correct installation of the water heater and for compliance with all national, state/provincial, and local codes.
- The manufacturer does not recommend installing the water heater in a pit or location where gas and water can accumulate.
- Do not attach the gas line to the water heater until after the gas line system pressure test for leaks has been completed. See page 18 for additional information.
- Do not have the vent terminal pointing toward any operating window, door, or opening into a building or other area where people gather, where combustion gases could create a nuisance or hazard or cause property damage.
- Do not install next to any source of airborne debris, such as a clothes dryer, that can cause debris to be trapped inside the combustion chamber.
- Do not install the unit where water, debris, or flammable vapors may get into the flue terminal or the air intake line.
- **The manufacturer does not recommend installing the water heater in an attic due to safety issues.** If you install the water heater in an attic:
 - Make sure the unit will have enough combustion air and proper ventilation. Failure to do so could lead to carbon monoxide poisoning or death.
 - Keep the area around the water heater clean. When dust collects on the flame sensor, the water heater will shut down on an error code.
 - Place the unit where it will allow easy access for service and maintenance.
 - A drain pan, or other means of protection against water damage, is recommended to be installed under the water heater in case of leaks. See the NOTICE below.
- **The water heater must be securely mounted to a wall or other suitable structure so that it is level (left-to-right & front-to-back) and plumb (vertically).**
- **Failure to observe these warnings could result in severe personal injury, death, and/or property damage.**

NOTICE

- **The warranty will not cover damage caused by water quality.**
 - Only potable water can be used with this water heater. Do not introduce pool or spa water, or any chemically treated water into the water heater.
 - Introduction of water with iron greater than 0.3 mg/L.
 - Water pH levels must be between 6.5 and 8.5.
 - Well water must be treated.
- Although the water heater is designed to operate with minimal sound, **the manufacturer does not recommend installing the unit on a wall adjacent to a bedroom, or a room that is intended for quiet study or meditation, etc.**
- Locate your water heater close to a drain where water leakage will not do damage to surrounding areas. As with any water heating appliance, the potential for leakage at some time in the life of the product does exist. A drain pan, or other means of protection against water damage, is recommended to be installed under the water heater in case of leaks. In addition, you may install an active water leak detector with a shutoff valve which can turn off the water supply in the event of a leak. The manufacturer is not responsible for damage due to water leaks. If you install a drain pan under the unit, ensure that it will not restrict the combustion air flow.
- This water heater is not suitable for combination water (potable) heating, space heating and/or a recirculation system with a dedicated return line.

CLEARANCES



WARNING

Maintain all clearances around the water heater. Failure to do so could create a fire hazard, potentially leading to death, serious injury, and/or property damage.

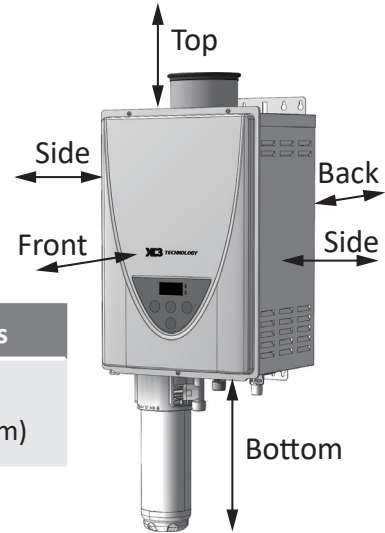

Top	Bottom	Front	Back	Sides
12 in (305 mm)	18 in (458 mm)	4 in* (102 mm)	1 in (25 mm)	3 in (76 mm)

*24 inches (610 mm) recommended for maintenance.

INCLUDED ACCESSORIES

Check that these items below are included with the water heater.

Installation manual & Owner's guide	X3™ cartridge	LP Conversion Kit (100357126)	Pressure relief valve
 Qty: 1	 100314491	 100281157 Manifold attachments: 2 Small / 1 Large Manifold gasket (100281157): 1 Gas conversion sticker: 1 Gas conversion instruction: 1 Spare screw: 2	

OPTIONAL ITEMS

#	Model
1.	Condensate Collector and Trap
2.	Concentric Sidewall Termination Kit
3.	Concentric Roof Termination
4.	Elbow
5.	Straight Pipe
6.	Roof Flashing
7.	Pipe Hanger
8.	Remote Controller
9.	X3™ Cartridge Anti-Freeze Kit

1. Condensate Collector and Trap



2. Concentric Sidewall Termination Kit

It includes one Sidewall Termination*, one 87° Elbow, two Wall Plates, one Flue Adapter



*This sidewall termination should be installed with the label printed "TOP" facing up and the drain hole of the termination facing down to prevent rainwater from entering the air intake and exhaust system.

The flue adapter must be used in a vent system of 8 ft (equivalent) or less. **NOTICE: The flue adapter **MUST ONLY** be installed in the water heater flue. It cannot be used at any other location in the vent system. Vertical installations do not require this flue adapter. The flue adapter can be made in the field using a 10" straight pipe (100266133) by removing 1.5" of the outer plastic pipe from the male end. If using other commercially available metal/plastic concentric venting, remove 1.5" of the outer plastic pipe by following the manufacturer's instructions.



3. Concentric Roof Termination

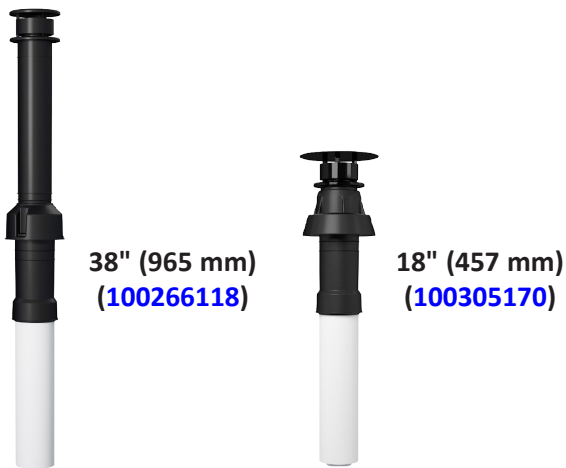

4. Elbow



5. Straight Pipe



10" (254 mm) (100266133)
19.5" (495 mm) (100266134)
39" (991 mm) (100266135)

6. Roof Flashing



Tile / Shingle Roof Flashing
1/12 to 6/12 Pitch (100266136)
8/12 to 16/12 Pitch (100266137)
6/12 to 12/12 Pitch (100266138)

Flat Roof Flashing
(100266187)

7. Pipe Hanger (100266141)



8. Remote Controller (100209924/TM-RE42)



This remote can be added to the heater, in addition to the built-in controller.

9. X3™ Cartridge Anti-Freeze Kit (100325654)

This kit is recommended for cold environment installation to protect the X3™ Cartridge. The kit includes a 120 volt heat trace wire and an insulation blanket.

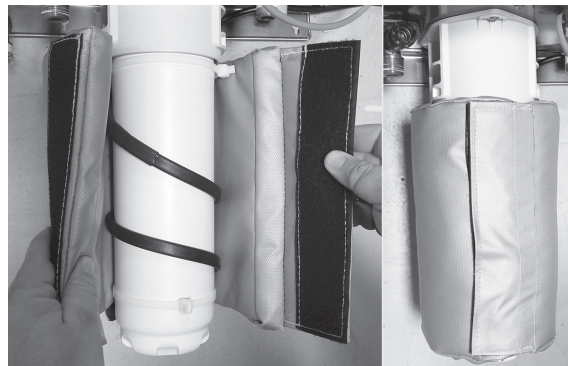

WARNING FOR INSTALLATIONS

FOR YOUR SAFETY, READ BEFORE INSTALLATION:



WARNING

- Do not install the water heater and its termination where water, debris or flammable vapors may get into the water heater and flue terminal.
- Do not have the vent terminal pointing toward any opening into a building.
- Do not locate your heater in a pit or location where gas and water can accumulate.
- Failure to observe these warnings could result in carbon monoxide poisoning or death.

NOTICE

Improper installation will void the warranty and may cause damage to the water heater.

Ensure that you meet the minimum clearances shown below for a direct vent termination:

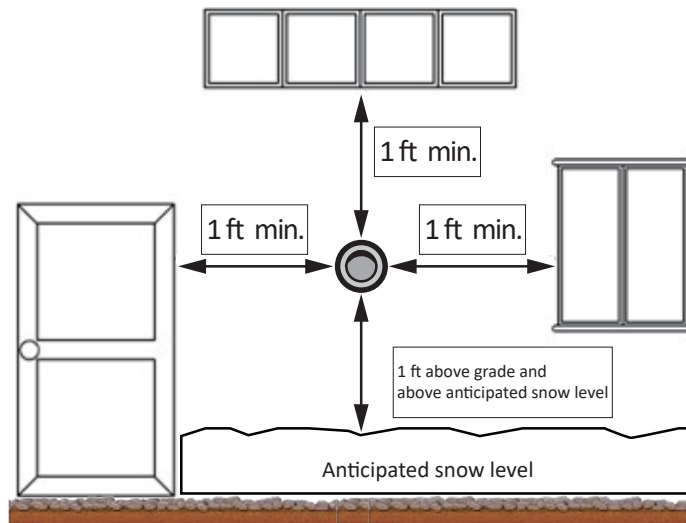

Locate the vent terminal to meet the following clearances:
2 ft from an inside corner
2 ft from an outside corner
3 ft below a soffit/overhang

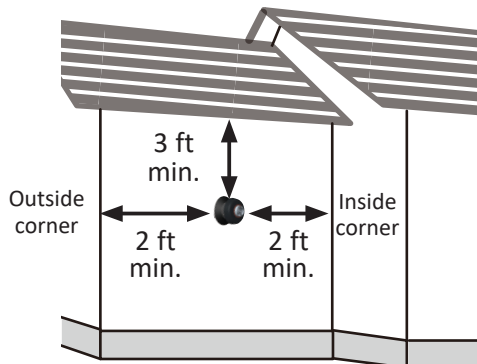

Do not install the water heater or vent termination next to a dryer or dryer vent. The water heater environment must be free from any source of airborne debris that can be trapped inside the water heater.

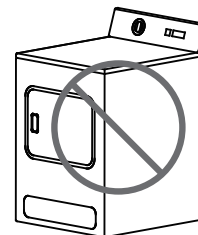

HIGH-ALTITUDE INSTALLATIONS



WARNING

- Adjust the appropriate DIP switches according to model and elevation as shown below. **DO NOT** adjust the other DIP switches.
- Turn off the power supply to the water heater before changing the DIP switch settings.
- Failure to observe these warnings could lead to carbon monoxide poisoning or death.

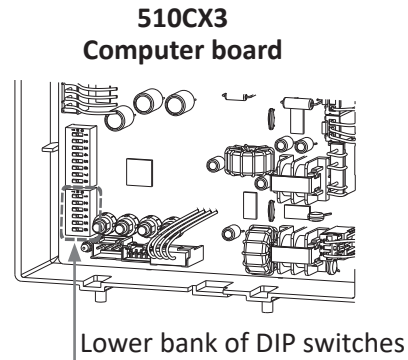
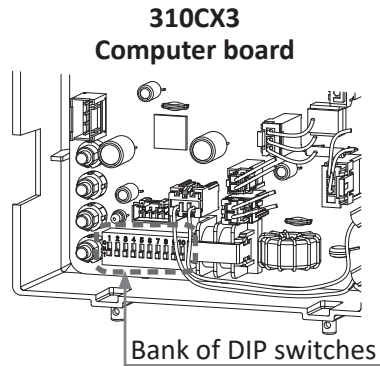

Installation altitude

The maximum certified or allowable installed altitude is 10,100 ft (3,078 m) for 310CX3, and 510CX3 models.

The black squares indicate the correct DIP switch positions for high altitude installation.

310CX3 : Only adjust DIP switch No. 3, No. 4, and No. 5.

510CX3 : Only adjust DIP switch No. 2, No. 3, and No. 4 on the lower bank.

Altitude Model	0 to 2,000 ft (0 to 609 m) DEFAULT	2,001 ft to 3,000 ft (610 m to 914 m)	3,001 ft to 5,000 ft (915 m to 1,524 m)	5,001 ft to 7,500 ft (1,525 m to 2,286 m)	7,501 ft to 10,100 ft (2,287 m to 3,078 m)
310CX3	<p>No. 3 : OFF No. 4 : OFF No. 5 : OFF</p>	<p>No. 3 : OFF No. 4 : ON No. 5 : OFF</p>	<p>No. 3 : OFF No. 4 : OFF No. 5 : ON</p>	<p>No. 3 : ON No. 4 : ON No. 5 : ON</p>	<p>No. 3 : ON No. 4 : ON No. 5 : ON</p>
510CX3 (Lower bank of DIP switches)	<p>No. 2 : OFF No. 3 : OFF No. 4 : OFF</p>	<p>No. 2 : OFF No. 3 : ON No. 4 : OFF</p>	<p>No. 2 : OFF No. 3 : OFF No. 4 : ON</p>	<p>No. 2 : ON No. 3 : ON No. 4 : ON</p>	<p>No. 2 : ON No. 3 : ON No. 4 : ON</p>

VENTING INSTRUCTIONS



WARNING

- Improper venting of this appliance can result in excessive levels of carbon monoxide which can result in severe personal injury or death.
- Improper installation can cause nausea or asphyxiation, severe injury or death from carbon monoxide and flue gases poisoning. Improper installation will void product warranty.
- When installing the vent system, all applicable national and local codes must be followed. If you install thimbles, fire stops or other protective devices and they penetrate any combustible or noncombustible construction, be sure to follow all applicable national and local codes.

The water heater must be vented in accordance with "Venting of Equipment" in the current edition of the National Fuel Gas Code: ANSI Z223.1/NFPA 54 as well as applicable local building codes.

The water heater is designed for a concentric venting system, which uses one pipe system with two ducts for combustion air and exhaust air. **The manufacturer approves the use of Centrotherm Eco Systems Direct Vent APNC35 venting systems on new installations. This system is furnished through the heater manufacturer. See the table below for certified vent terminations.**

General rules for venting water heaters:

- Place the water heater as close as possible to the vent termination.
- Do not weld the vent pipe to the water heater's vent collar.
- Do not cut the vent collar of the unit.
- The vent must be easily removable from the top of the water heater for normal service and inspection of the unit and vent system.
- The water heater vent must not be connected to any other gas appliance or vent stack.
- Avoid using an oversized vent pipe or using extremely long runs of the pipe.
- Do not common vent or connect any vent from other appliances to the water heater vent.
- The vent should slope towards the heater and condensate collector ([100266140](#)). The condensate trap ([100266139](#)) must be installed below the condensate collector's drain nipple to keep condensate from draining back into the heater's exhaust and causing damage. These two venting components must be installed in roof top terminations and when horizontal terminations exceed 8 feet (2.4 m) of equivalent vent length, excluding the sidewall termination. Condensate is corrosive and should be treated and disposed of according to local codes. The condensate collector and condensate trap need periodical maintenance according to the manufacturer's instructions.

General rules for vent terminations:

- Avoid locating the water heater vent termination near **any air intake devices**. These fans can pick up the exhaust flue products from the water heater and return them to the building. This can create a health hazard.
- Locate the vent termination so that it cannot be blocked by any debris and snow, at any time. Most codes require that the termination must be at least 12 in (305 mm) above grade and anticipated snow line, but the installer may determine if it should be higher depending on the job site condition and applicable codes.
- A proper sidewall termination is required when the water heater is vented through a sidewall.
- Regarding the clearances from the exhaust termination to the air inlet or opening, refer to pages 11, 16, and 17.

Use	Vent Brand	Description	Model Number
New Installation (New Venting)	Centrotherm Eco Systems Direct Vent APNC35	11-1/2" Concentric, Sidewall Termination* Kit	100322374
		21" Concentric, Sidewall Termination* Kit	100322375
		38" Roof Termination	100266118
		18" Roof Termination	100305170

*This sidewall termination should be installed with the label printed "TOP" facing up and the drain hole of the termination facing down to prevent rainwater from entering the air intake and exhaust system.

-Vent length and no. of elbows-

- For best results, a vent system should be as short and straight as possible.
- This water heater must be vented with approved concentric venting as described on page 13.
- **Follow the vent pipe manufacturer's instructions and the instructions in this manual when installing the vent pipe.**
- **Do not common vent this appliance with any other vented appliance.** (Do not terminate vent inside a chimney. If the vent must go through the chimney, it must run through the top of the chimney and terminate with the roof termination listed on page 10. Install per the vent manufacturer's instructions.)
- When the horizontal vent run exceeds 5 ft (1.5 m), support the vent run at 3 ft (0.9 m) intervals with overhead hangers.
- The maximum length of exhaust vent piping must not exceed 43 ft (13.1 m) (deducting 5 ft (1.5 m) for each 87° elbow used in the venting system). Do not use more than 4 pieces of 87° elbows.

NOTE: If an 87° elbow connects to the vent collar directly, the connection is equivalent to 15 ft (4.6 m) of vent length. When using this connection, be sure to calculate total vent length including the connection part as 15 ft (4.6 m).

Vent type	Diameter	Max. No. of 87° Elbows	Max. Vertical and Horizontal (Total) Vent Length	No. of 87° Elbows	Max. Vertical or Horizontal Vent Length
				0	43 ft (13.1 m)
Concentric	3 in/5 in	4	43 ft (13.1 m)	1	38 ft (11.6 m)
				2	33 ft (10.1 m)
				3	28 ft (8.5 m)
				4	23 ft (7.0 m)

For each 87° elbow added, deduct 5 ft (1.5 m) from max. vent length. Two 45° elbows are equivalent to one 87° elbow.

Excludes the Concentric termination

-DIP switch settings for vent length-



WARNING

- Adjust the appropriate DIP switches according to model and vent length as shown below. **DO NOT** adjust the other DIP switches.
- Turn off the power supply to the water heater before changing the DIP switch settings.
- Failure to observe these warnings could lead to carbon monoxide poisoning or death.

310CX3:

Only adjust DIP switch No. 6, No. 7, and No. 8.

510CX3:

Only adjust DIP switch No. 3, No. 4, and No. 5 on the upper bank.

510CX3 Computer board

Upper bank of DIP switches

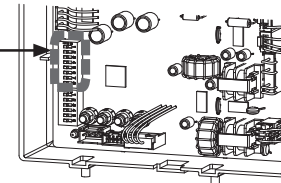

The black squares indicate the correct DIP switch positions for vent length.

Vent length Model	0 to 8 ft (0 to 2.4 m) DEFAULT	8 to 20 ft (2.5 to 6.1 m)	20 to 30 ft (6.2 to 9.1 m)	30 to 43 ft (9.2 to 13.1 m)
310CX3	ON OFF 1 2 3 4 5 6 7 8 9 10	ON OFF 1 2 3 4 5 6 7 8 9 10	ON OFF 1 2 3 4 5 6 7 8 9 10	ON OFF 1 2 3 4 5 6 7 8 9 10
	No. 6 : OFF No. 7 : OFF No. 8 : ON	No. 6 : ON No. 7 : OFF No. 8 : ON	No. 6 : OFF No. 7 : ON No. 8 : ON	No. 6 : ON No. 7 : ON No. 8 : ON
510CX3 (Upper bank of DIP switches)	ON OFF 1 2 3 4 5 6 7 8	ON OFF 1 2 3 4 5 6 7 8	ON OFF 1 2 3 4 5 6 7 8	ON OFF 1 2 3 4 5 6 7 8
	No. 3 : OFF No. 4 : OFF No. 5 : ON	No. 3 : ON No. 4 : OFF No. 5 : ON	No. 3 : OFF No. 4 : ON No. 5 : ON	No. 3 : ON No. 4 : ON No. 5 : ON

-Venting illustrations-

The condensate trap and collector are required when there is more than 8 ft (2.4 m) of equivalent vent length, excluding the vent termination. For details of the venting installation, refer to the Centrotherm Eco Systems Direct Vent APNC35 concentric venting installation manuals. X3™ CARTRIDGE is not shown.

Horizontal Installation

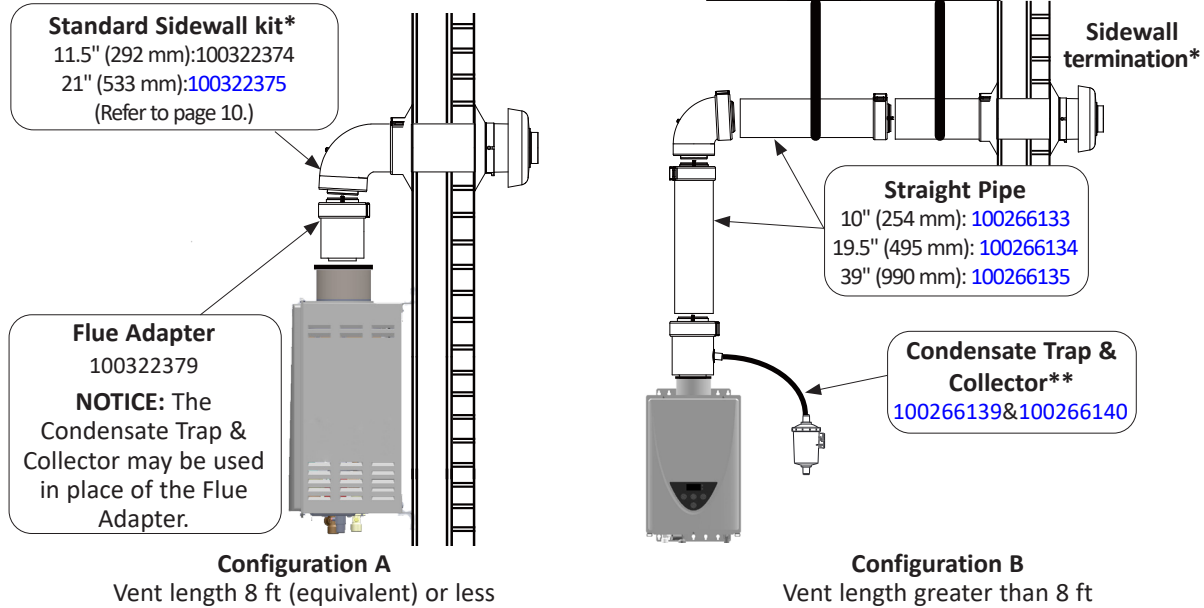

Vertical Installation

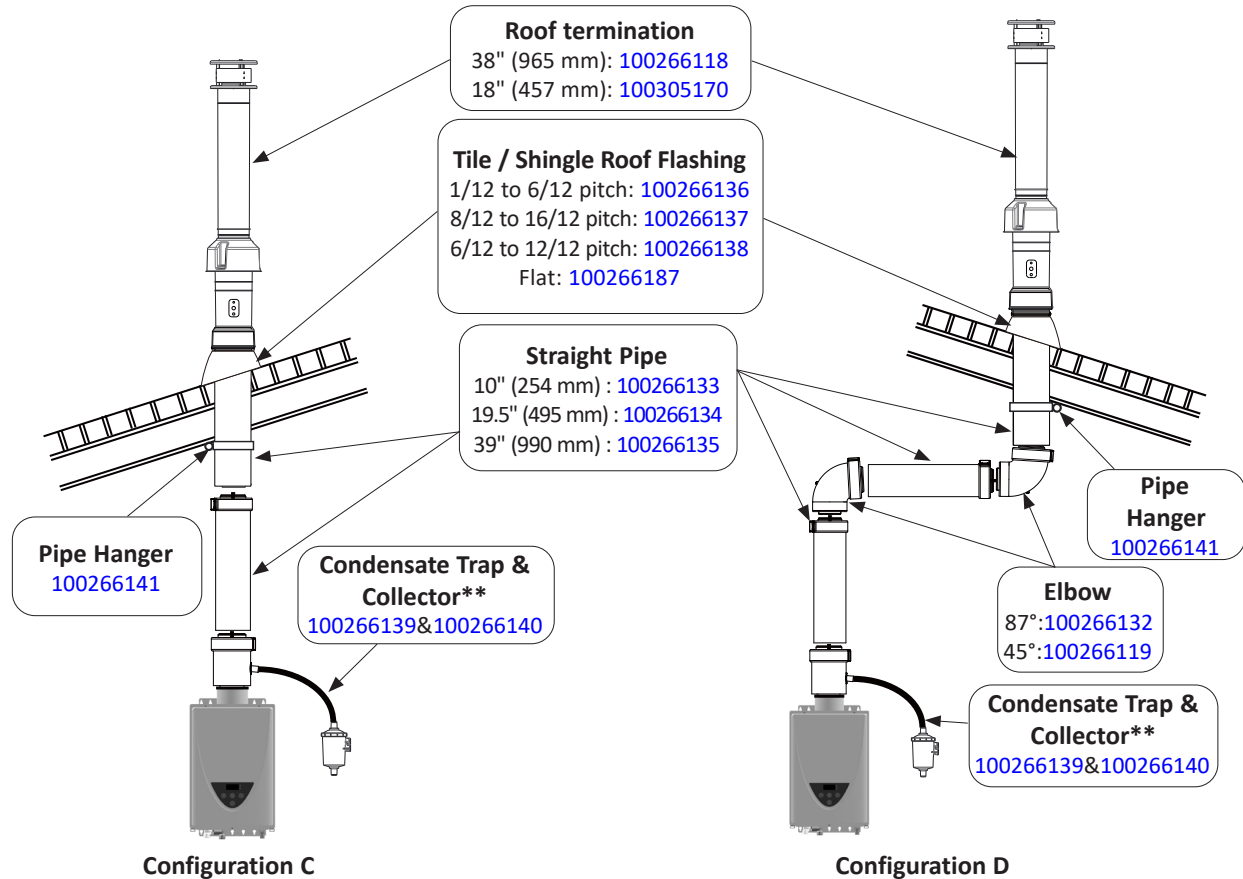

* This sidewall termination should be installed with the label printed "TOP" facing up and the drain hole of the termination facing down to prevent rainwater from entering the air intake and exhaust system.

**Condensate must be disposed of according to local code.

-Vent termination clearances-

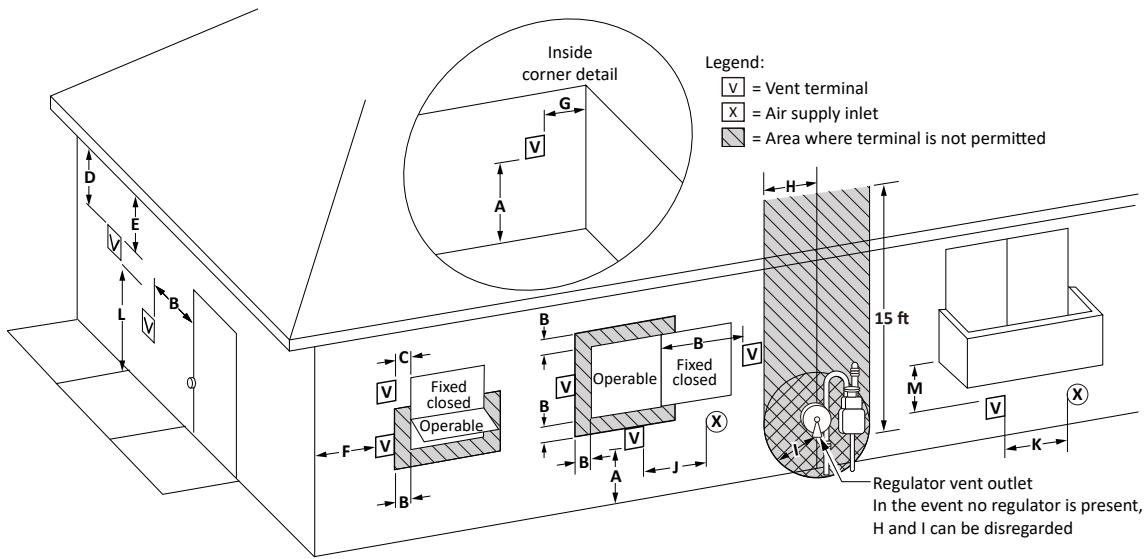

	Direct vent
A Clearance above grade, veranda, porch, deck, or balcony	1 ft (30 cm)
B Clearance to window or door that may be opened	1 ft (30 cm)
C Clearance to permanently closed window	0
D Vertical clearance to ventilated soffit located above the terminal within a horizontal distance of 2 ft (61 cm) from the center line of the terminal	3 ft (91 cm)
E Clearance to unventilated soffit	3 ft (91 cm)
F Clearance to outside corner	2 ft (61 cm)
G Clearance to inside corner	2 ft (61 cm)
H Clearance to each side of center line extended above meter/regulator assembly	*
I Clearance to service regulator vent outlet	*
J Clearance to non-mechanical air supply inlet to a building or the combustion air inlet to any other appliance.	1 ft (30 cm)
K Clearance to mechanical air supply inlet	3 ft (91 cm) above if within 10 ft (3 m) horizontally.
L Clearance above paved sidewalk or paved driveway located on public property	7 ft (213 cm)
M Clearance under veranda, porch deck, or balcony	1 ft (30 cm)**

*Clearance in accordance with local installation codes and the requirements of the gas supplier.

**Permitted only if veranda, porch, deck, or balcony is fully open on a minimum of two sides beneath the floor.

Notes:

- 1) In accordance with the current ANSI Z223.1/NFPA 54, National Fuel Gas Code
- 2) If locally adopted installation codes specify clearances different than those illustrated, then the most stringent clearance shall prevail.
- 3) Blocking air supply and exhaust vent by snow may cause incomplete combustion and an appliance failure. Install the termination by providing sufficient clearance from anticipated snow line in accordance with local code or manufacture's instructions and make sure there is no blockage.
- 4) Provide an appropriate clearance between a vent termination and a building to prevent degradation to building materials caused by flue gases.



Improper installation can result in carbon monoxide poisoning or death. Follow all local and national codes in regards to proper termination clearances. In the absence of such codes, the clearances below can be used as guidelines. Local codes supersede these guidelines.

-Clearances for sidewall terminations-

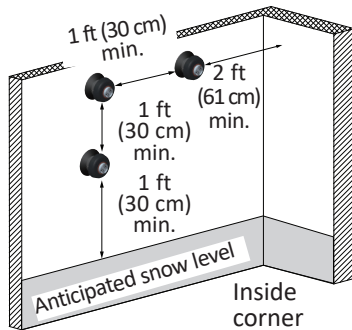

Multiple-unit, concentric wall terminals: Space each concentric wall terminal at least 1 ft (30 cm) away from each other, no matter the orientation. A concentric wall terminal must also be at least 2 ft (61 cm) away from an inside corner. If the adjacent wall is less than 2 ft (61 cm) of length, the minimum required distance away from the inside corner will be equal to the length of that adjacent wall.

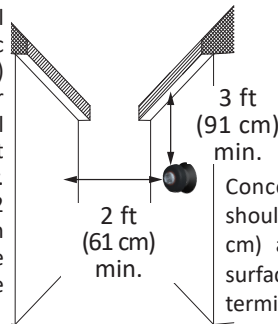

Concentric wall terminals should be at least 3 ft (91 cm) away from a ventilated or unventilated soffit.

Concentric wall terminals should be at least 2 ft (61 cm) away from an opposite surface/wall. Do not place the termination directly in front of an opening into a building.

-Clearances for rooftop terminations-

Angled roof termination

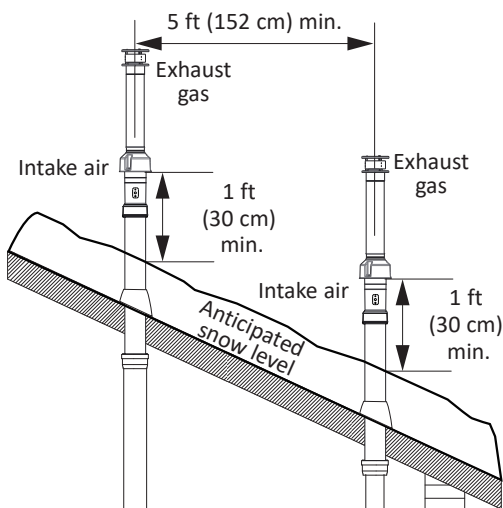

Flat roof termination

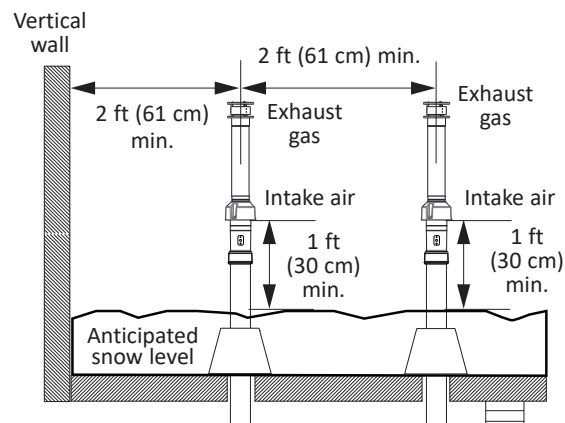

- Minimum spacing between multiple concentric terminals for rooftop:
 - On the same level: 2 ft (61 cm) spacing between each
 - On the different level: 5 ft (152 cm) spacing between each
- The exhaust termination must be a horizontal distance of at least 2 ft (61 cm) from a wall or surface unless specified differently by local code.
- Failure to observe this warning may result in severe personal injury or death.

GAS SUPPLY AND GAS PIPE SIZING

-General-



WARNING

- Do not use this water heater with any gas other than the one listed on the rating plate unless the water heater has been properly converted.
- Ensure that any and all gas regulators used are operating properly and providing gas pressures within the specified range shown below. Excess gas inlet pressure may cause serious accidents.
- If your water heater needs a gas conversion, refer to the instructions supplied with the heater and included with the conversion components.
- Failure to observe these warnings could result in severe personal injury, carbon monoxide poisoning, or death.

- The minimum and maximum inlet gas pressures

Gas type	Inlet gas pressure
Natural Gas	Min. 4.0" W.C. (1.00 kPa) – Max. 10.5" W.C. (2.61 kPa)
Propane	Min. 8.0" W.C. (1.99 kPa) – Max. 14.0" W.C. (3.48 kPa)

- Inlet gas pressures that fall outside the range of values listed above may adversely affect the performance of the water heater. These pressures are measured when the water heater is in full operation and in standby.
- Inlet gas pressure must not exceed the above maximum values; gas pressure above the specified range will cause dangerous operating conditions and damage to the unit.
- Until testing of the main gas line supply pressure is completed, ensure the gas line to the water heater is disconnected to avoid any damage to the water heater.
- If the gas supply pressure to the heater is greater than the specified maximum, a field-supplied regulator is required. The regulator must lower the gas pressure within the approved range.
 - Install the gas regulator according to the manufacturer's instructions.
 - The regulator must be sized for the water heater input and provide the specified pressures that are listed on the rating plate.
 - In the absence of a minimum installation distance stated by the regulator manufacturer, it is recommended that there is at least 3 ft (1 m) of piping between the regulator outlet and the water heater's inlet gas connection.

-Gas connections-

1. Install a full port, manual gas shutoff valve between the water heater and the gas supply line.
2. When the gas connections are completed, it is necessary to perform a gas leak test either by applying soapy water to all gas fittings and observing for bubbles or by using a gas leak detection device.
 - The water heater and its individual shutoff valve must be disconnected from the gas supply piping system during any pressure testing of that system at test pressures in excess of 1/2 psi (3.5 kPa).
 - The water heater must be isolated from the gas supply piping system by closing its individual manual shutoff valve during any pressure testing of the gas supply piping system at test pressures equal to or less than 1/2 psi (3.5 kPa).
3. Always purge the gas line of any debris and/or water before connecting to the gas inlet.

NOTICE

Size the gas pipe to supply the necessary volume of gas for the water heater. Refer to and follow the requirements listed in the current edition of ANSI Z223.1/NFPA 54. Otherwise, flow capabilities and output temperatures will be limited.

-Natural gas supply piping-

Maximum delivery Capacity of Cubic Feet of Gas per Hour of IPS Pipe carrying Natural Gas with 0.60 Specific Gravity Based on Pressure Drop of 0.5" W.C.

Based on Energy Content of 1,000 BTU/Cubic ft: The water heater requires 190 Cubic ft/hr for 310CX3, and 199 Cubic ft/hr for the 510CX3 model.

Unit: Cubic feet per hour

Pipe Size	Length: ft (m)												
	10' (3.1)	20' (6.1)	30' (9.1)	40' (12.2)	50' (15.2)	60' (18.3)	70' (21.3)	80' (24.4)	90' (27.4)	100' (30.5)	125' (38.1)	150' (45.7)	200' (61.0)
1/2"	172	118	95	81	72	65	60	56	52	50	44	40	34
3/4"	360	247	199	170	151	137	126	117	110	104	92	83	71
1"	678	466	374	320	284	257	237	220	207	195	173	157	134
1-1/4"	1,309	957	768	657	583	528	486	452	424	400	355	322	275
1-1/2"	2,090	1,430	1,150	985	873	791	728	677	635	600	532	482	412
2"	4,020	2,760	2,220	1,900	1,680	1,520	1,400	1,300	1,220	1,160	1,020	928	794

-Propane (LP) supply piping-

Maximum Capacity of Propane (LP) Based on 11" W.C. supply pressure at a 0.5" W.C. pressure drop

Unit: kBtu per hour

Pipe Size	Length: ft (m)												
	10' (3.1)	20' (6.1)	30' (9.1)	40' (12.2)	50' (15.2)	60' (18.3)	70' (21.3)	80' (24.4)	90' (27.4)	100' (30.5)	125' (38.1)	150' (45.7)	200' (61.0)
1/2"	268	184	148	126	112	101	93	87	82	77	68	62	53
3/4"	567	393	315	267	237	217	196	185	173	162	146	132	112
1"	1,071	732	590	504	448	409	378	346	322	307	275	252	213
1-1/4"	2,205	1,496	1,212	1,039	913	834	771	724	677	630	567	511	440
1-1/2"	3,307	2,299	1,858	1,559	1,417	1,275	1,181	1,086	1,023	976	866	787	675
2"	6,221	4,331	3,465	2,992	2,646	2,394	2,205	2,047	1,921	1,811	1,606	1,496	1,260

Gas sizing example (Natural Gas)

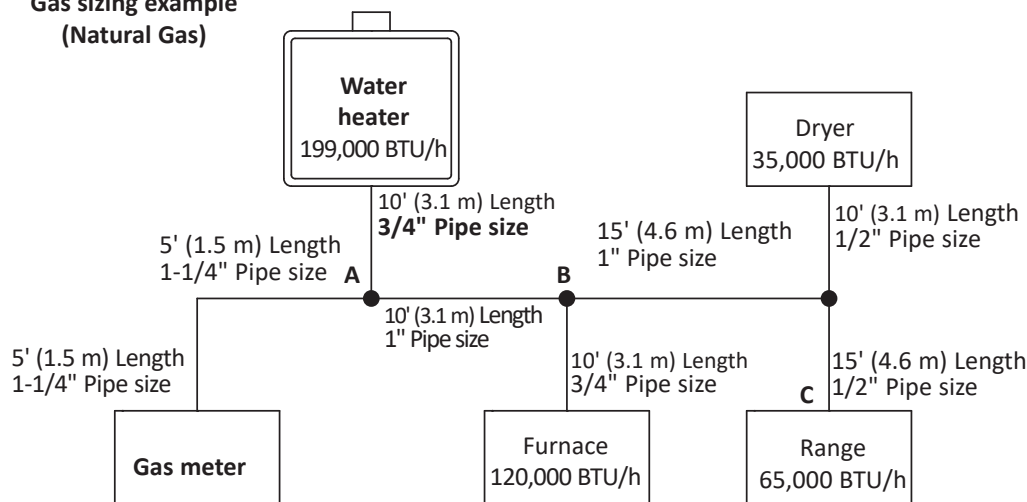

Based on Energy Content of 1,000 BTU/Cubic ft:

Divide each appliance's BTU/h requirement by 1,000 BTU/ft³ to get the appliance's ft³/h requirement.

Take into account the distance the appliance is from the gas meter, then look in the above gas chart to properly size the line.

For sections of the

gas line supplying gas to more than one appliance (Ex: Point A to Point B), add up the cubic ft per hour requirements of the appliances that are being supplied by that section, and size to the farthest appliance.

For Example: The section from A to B supplies gas to the furnace, range and dryer. Adding up the BTU/h requirements and dividing by 1,000 yields a cubic ft per hour requirement of 220 cubic ft of gas per hour. The farthest appliance is the range, which is 50 ft (15.2 m) away from the meter. According to the chart above, the 50 ft (15.2 m) column shows that Section A to B must be 1" in order to supply 220 cubic ft per hour.

WATER CONNECTIONS



WARNING

Do not use this appliance if any part has been under water. Immediately contact a qualified installer or service agency to replace a flooded water heater. Do not attempt to repair the unit! It must be replaced!

NOTICE

Do not reverse the hot outlet and cold inlet connections to the water heater. This will prevent the water heater from activating properly.

All pipes, pipe fittings, valves and other components, including soldering materials, must be suitable for potable water systems.

1. A manual shutoff valve must be installed on the cold water inlet to the water heater between the main water supply line and the water heater.
2. In addition, a **manual shutoff valve** is also recommended on the hot water outlet of the unit. **Isolation valves** with hose bibbs for service are available.
3. If the water heater is installed within, or subjected to, a closed loop water system, a **thermal expansion tank or a code approved device to handle thermal expansion** must be installed. NOTE: If the plumbing system is subject to water hammer, then it is recommended that water hammer arrestors be installed.
4. Before installing the water heater, flush the water line to remove all debris, and after installation is complete, purge the air from the line. Failure to do so may cause damage to the water heater.
5. There is a wire mesh filter within the cold inlet to trap debris from entering your heater. This will need to be cleaned periodically to maintain optimum flow. (Refer to page 35.)

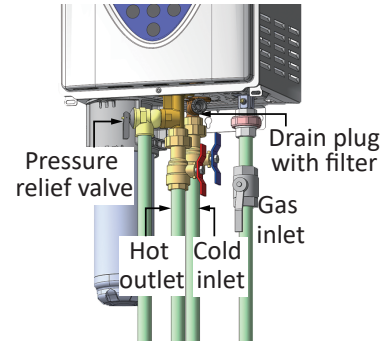

-Pressure relief valve-

The water heater has a high-temperature shutoff switch built in as a standard safety feature (called a Hi-Limit switch) therefore a "**pressure only**" relief valve is required.

- An approved pressure relief valve is supplied with your water heater and must be installed on the outlet connection. NOTE: When an isolation valve kit that includes a pressure relief valve is installed on the water heater, use the provided $\frac{3}{4}$ " male NPT plug to close the pressure relief port on the outlet connection.
- The discharge piping for the pressure relief valve must be directed so that the hot water cannot splash outward and cause damage or personal injury.
- Attach the discharge tube to the pressure relief valve and run the end of the tube to within 6 in (152 mm) from the floor. This discharge tube must allow free and complete drainage without any restrictions. **WARNING!** Do Not plug the pressure relief valve.
- If the pressure relief valve discharges periodically, this may be due to thermal expansion in a closed water supply system. Contact the water supplier or a local plumbing professional on how to correct this situation.
- The pressure relief valve must be manually operated periodically to check for correct operation. Before operating the valve manually, check that it will discharge in a place for secure disposal.
- No valve must be placed between the relief valve and the water heater.

If another pressure relief valve is used or needs to be replaced, it must meet the following:

- The pressure relief valve must conform to **ANSI Z21.22 · CSA 4.4** and installation must follow local codes.
- The discharge capacity must be at least 190,000 BTU/h for the 310CX3 model, and 199,000 BTU/h for the 510CX3 model.
- The pressure relief valve needs to be rated for a maximum of 150 psi (1 MPa).



WARNING





Hot water could be released when the pressure relief valve is opened. This could result in severe personal injury. Before operating the pressure relief valve manually, check that it will discharge in a safe place. If water does not flow freely from the end of the discharge pipe, turn the gas supply and power OFF and call a qualified person to determine the cause. Refer to the pressure relief valve manufacturer's instructions for inspection and maintenance requirements.

-X3™ Scale Prevention Technology-



This water heater is equipped with X3™ Scale Prevention Technology to inhibit scale formation within the heat exchanger tubing of this unit. Part of the X3™ Technology's anti-scale protection comes from the special X3™ Cartridge media. The X3™ Cartridge must be installed into the manifold located on the underside of the heater cabinet prior to operation of the unit (shown as follows). The X3™ system is designed to be hassle-free; eliminating the need to drain the heater for installation, removal, or replacement of the cartridge. X3™ Scale Prevention Technology reduces the formation of scale in the heat exchanger, extending the operating life of the unit in typical potable water installations. Specific water conditions may impact the efficiency of X3™, such as excessive iron (>0.3 mg/l). Consult a water quality expert to determine if your water is within acceptable X3™ and EPA guidelines.

X3™ Technology Installation/Removal

Installation -

1. Align the  symbol with the  symbol and insert the X3™ Cartridge into the X3™ manifold
2. Turn it right until the  symbol aligns with the  symbol.

Removal -

1. Close the shutoff valve on the cold water supply.
2. Turn off the power supply.
3. Open a hot water fixture to relieve water pressure in the heater.
4. If a drain pan is not installed, place a bucket or pan underneath the X3™ Cartridge as some water may be present when removing.
5. Turn the X3™ Cartridge left until the  symbol aligns with the  symbol.
6. Pull down to remove it from the water heater. It is normal for a small amount of water to drip.

NOTE: the cartridge will be full of water. Take care to not tilt it till you can drain the water.

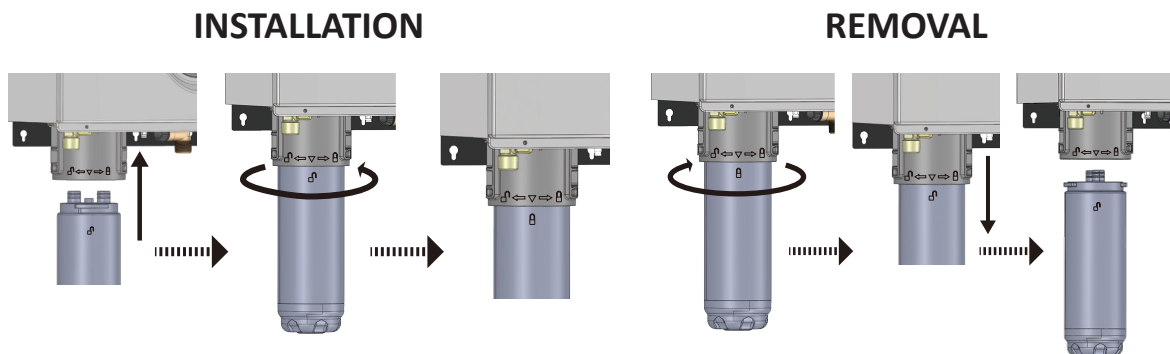

ELECTRICAL CONNECTIONS



- Follow the electrical code requirements of the local authority having jurisdiction. In the absence of such requirements, follow the current edition of the National Electrical Code ANSI/NFPA 70.
- When servicing or replacing parts within the water heater, label all wires prior to disconnection to facilitate an easy and error-free reconnection. Wiring errors can cause improper and dangerous operation. Verify proper operation after servicing.
- Failure to observe these warnings could result in personal injury or loss of life.

All concentric vent models come with a power plug.

1. The water heater requires **120 VAC, 60 Hz electrical power supply that is properly grounded.** A proper disconnect (i.e. on/off switch, power plug, etc.) controlling the main power to the water heater must be provided for service reasons. (Must comply with local codes.)
2. The use of a surge protector is recommended in order to protect the unit from power surges.







TEMPERATURE REMOTE CONTROLLER

-Optional item-

- The remote controller is an optional accessory that can be installed in a hall, closet, etc., to allow for temperature adjustment without having to go to the heater.
- When installed, the remote will take priority over the built-in controller.

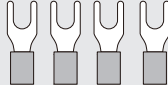
Verify that the items listed below are included with the remote controller **100209924 (TM-RE42)**.

Temperature remote controller	Screws	Fork terminals	Manual
 Qty: 1	 Qty: 2	 Qty: 4	 Qty: 1

-Installation-



WARNING

- **This remote controller is NOT waterproof.**
- **The water heater can only have one remote controller.**
- Do not install in high temperature environments, high humidity conditions, outdoors, in direct sunlight, or within the reach of children.
- Make sure the remote controller does not come into contact with water or oil.

NOTICE

- Do not place the remote controller cable close to other wires from other products.
- Cables used for the remote controller connection must be:
 - Minimum 20 gauge wire (No polarity)
 - Maximum 400 ft (122 m) long

<Mounting and wiring the remote controller>

1. Take off the **Back plate** from the remote controller with a flat head screwdriver. **(Fig. A and B)**
2. Attach the **Back plate** on the wall with the two provided screws. **(Fig. B)**

Fig. A

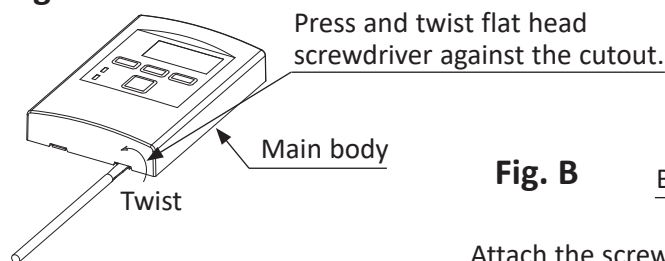
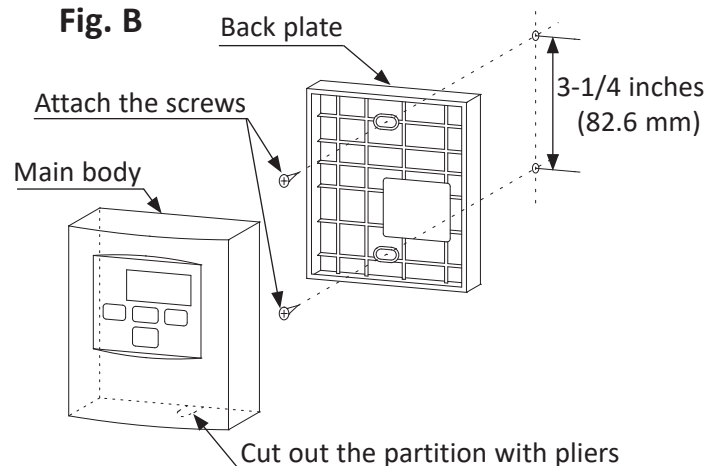
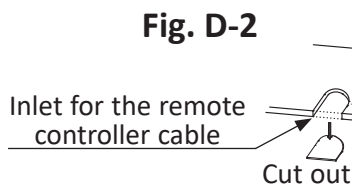
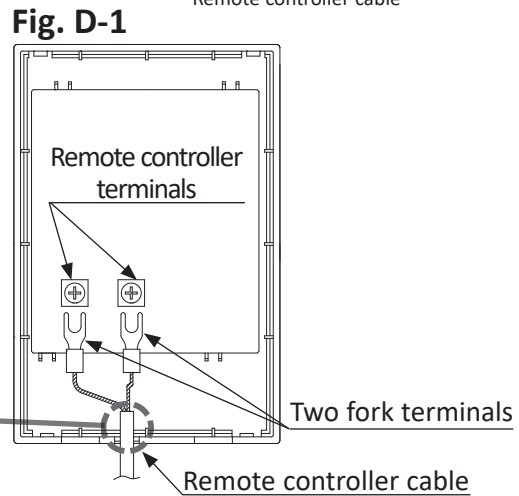
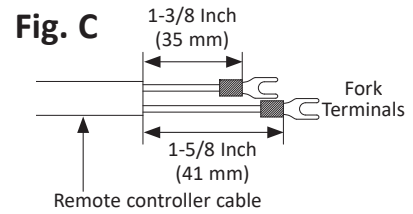

Fig. B



3. Crimp the **Fork terminals** to the cable. (**Fig. C**)
4. Tighten the two **Fork terminals** beneath the two **Remote controller terminal** screws on the back of the main body. (**Fig. D-1**)
5. Cut out the inlet for the remote controller cable from the bottom of the main body. (**Fig. D-2**)
6. Place the **Main body** back on the **Back plate**, with the **Remote controller cable** running out of the bottom inlet.



<How to connect the remote controller to the water heater>

1. Disconnect power supply from the water heater.
2. Take off the water heater's front cover.
3. Locate the two terminals for the remote controller in the water heater. (Refer to the Fig. E-1 and E-2.)
4. Put the remote controller cable through the hole at the bottom of the casing of water heater from outside.
5. Secure both terminals on the controller cable to the terminals in the cabinet as shown below. (Secure them underneath the screw terminals. No polarity.) See Figures E-1 and E-2.
* **Do NOT jump or short-circuit the wires, or the computer will be damaged.**
6. Replace the water heater's front cover securely.
7. Reconnect power supply to the water heater.

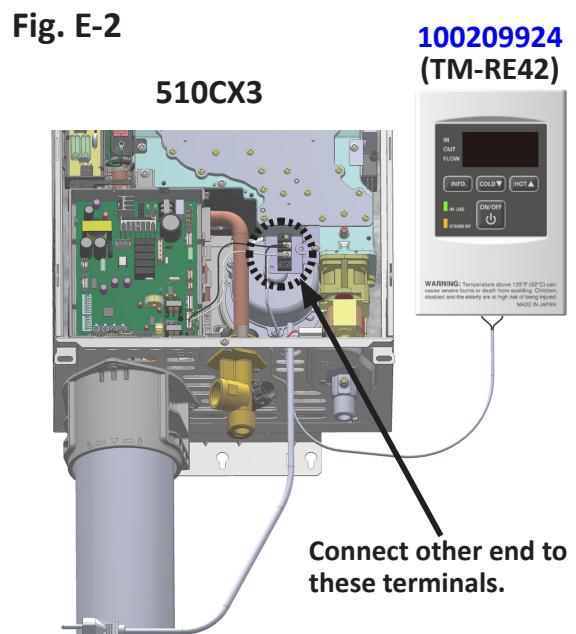
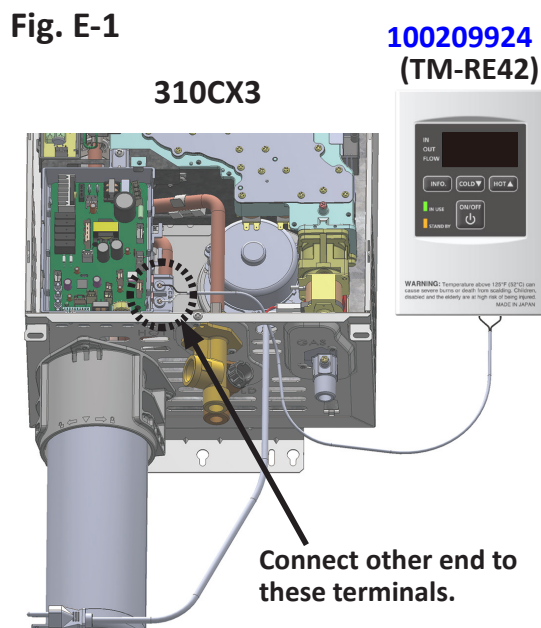

APPLICATIONS

Below are suggested piping diagrams for a standard installation and one with the use of a crossover valve. These diagrams are just a suggestion. Check with local codes and ordinances for additional installation requirements. Refer to the water heater manufacturer's website for additional layouts.

Thermostatic mixing valves may be used with tankless water heaters. Consult with the mixing valve manufacturer for the appropriate mixing valve for the application.

To reduce the risk of scalding, install Thermostatic Mixing Valves (temperature limiting valves) at each point of use.

These models are suitable for (potable) water heating only.

These models do not have Easy-Link or Multi-Unit capability.

NOTE: Installation with a dedicated return line is not approved by the manufacturer.

-Standard installation-

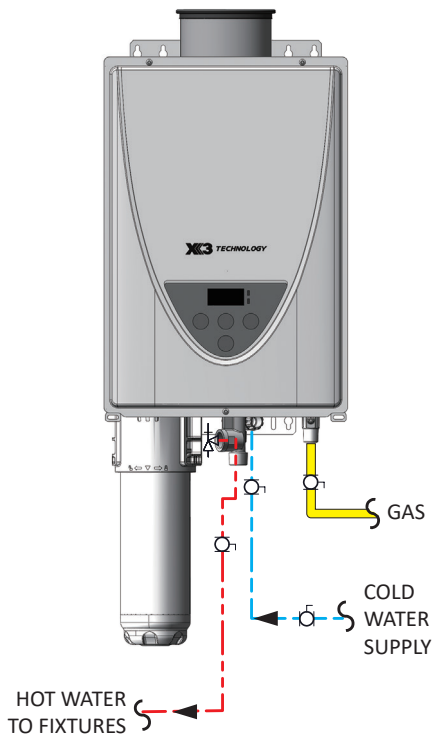

-Recirculation with cross over valve-

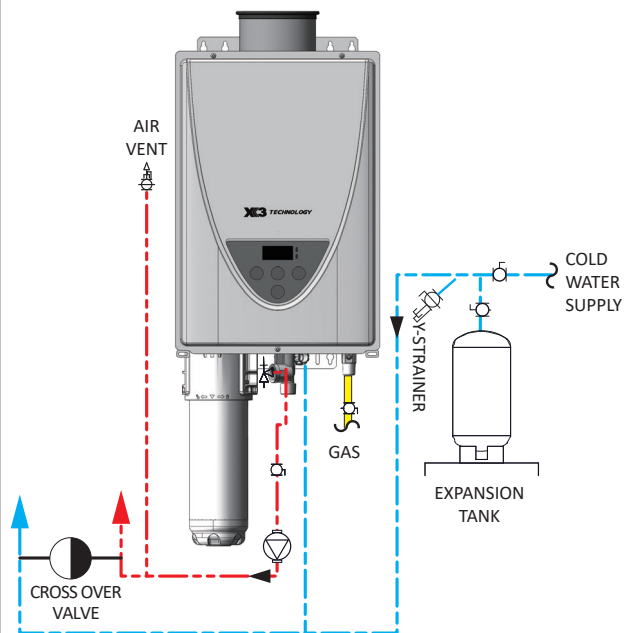

This installation is approved with the use of a crossover valve that maintain water temperature at the valve below 110°F, such as the APCOM® Bypass Valve for Tankless Water Heaters, model TBPV (kit 100327167).

NOTE: The cross over valve and pump do not come with the water heater. Install per pump manufacturer's instructions.

LEGEND		
	TEMPERATURE & PRESSURE RELIEF VALVE	
	PRESSURE RELIEF VALVE	
	DRAIN	

INITIAL OPERATION

FOR YOUR SAFETY, READ BEFORE OPERATING





- Check the **GAS and WATER CONNECTIONS** for leaks before firing unit for the first time.
- Open the main gas supply valve to the unit using only your hand to avoid any spark. Never use tools. If the knob will not turn by hand, do not try to force it; call a qualified service technician. Forced or attempted repair may result in a fire or explosion due to gas leaks.
- Be sure to check for the presence of leaking gas toward the bottom of the unit because some gases are heavier than air and may settle towards the floor.
- Check the **GAS PRESSURE**. Refer to page 18.
- Do not try to light the burner manually. It is equipped with an electronic ignition device which automatically lights the burner.
- Check for **PROPER VENTING and COMBUSTION AIR** to the water heater.
- Purge the **GAS and WATER LINES** to remove any air pockets.
- Do not use this appliance if any part has been under water. Immediately contact a qualified installer or service agency to replace a flooded water heater. Do not attempt to repair the unit! It must be replaced!



WARNING

IF YOU SMELL GAS:

- Do not try to start the water heater.
- Do not touch any electric switches; do not use any phone in your building.
- Immediately call your gas supplier from a neighbor's phone. Follow the gas supplier's instructions.
- If you cannot reach your gas supplier, call the fire department.

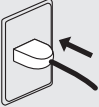
	Operation	
1.	Once the above checks have been completed, please clean the filter of any debris. Refer to page 35 for instructions.	
2.	Fully open the manual water control valve on the water supply line.	
3.	Open a hot water tap to verify that water is flowing to that tap, then close the hot water fixture.	
4.	Open the manual gas control valve fully.	
5.	Turn on the 120 VAC, 60 Hz power supply to the water heater.	

NOTE:

To reduce the risk of scalding, install Thermostatic Mixing Valves (temperature limiting valves) at each point of use.

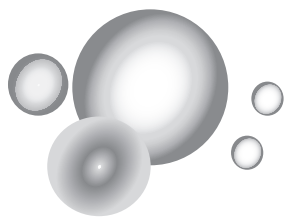

Owner's Guide

CONGRATULATIONS

Congratulations and thank you for choosing our tankless water heater. Before use, we recommend that you read through this owner's guide carefully. Keep this manual for future reference.

If you need an additional manual, contact the manufacturer or your local distributor. You may also download a manual from our web page. When you call, please tell us the product name and the serial number of your unit written on the rating plate of the water heater.

OPERATING SAFETY

FOR YOUR SAFETY READ BEFORE OPERATING

WARNING: If you do not follow these instructions exactly, a fire or explosion may result causing property damage, personal injury or loss of life.

A. This appliance does not have a pilot. It is equipped with an ignition device which automatically lights the burner. Do not try to light the burner by hand.

B. BEFORE OPERATING smell all around the appliance area for gas. Be sure to smell next to the floor because some gas is heavier than air and will settle on the floor.

WHAT TO DO IF YOU SMELL GAS

- Do not try to light any appliance.
- Do not touch any electric switch; do not use any phone in your building.
- Immediately call your gas supplier from a neighbor's phone. Follow the gas supplier's instructions.
- If you cannot reach your gas supplier, call the fire department.

C. Use only your hand to turn the gas shutoff valve. Never use tools. If the valve will not turn by hand, don't try to repair it, call a qualified service technician. Force or attempted repair may result in a fire or explosion.

D. Do not use this appliance if any part has been under water. Immediately contact a qualified installer or service agency to replace a flooded water heater. Do not attempt to repair the unit! It must be replaced!

OPERATING INSTRUCTIONS

1. STOP! Read the safety information above on this label.
2. Turn off all electric power to the appliance.
3. Do not attempt to light the burner by hand.
4. Turn the gas shutoff valve located on the outside of the unit to the closed position.
5. Wait five (5) minutes to clear out any gas. If you then smell gas, STOP! Follow "B" in the safety information above on this label. If you don't smell gas, go to the next step.
6. Turn the gas shutoff valve located on the outside of the unit to the open position.
7. Turn on all electrical power to the appliance.
8. If the appliance will not operate, follow the instructions in "To Turn Off Gas to Appliance," and call your service technician or gas supplier.

TO TURN OFF GAS TO APPLIANCE

1. Turn off all electric power to the appliance if service is to be performed.
2. Turn the gas shutoff valve located on the outside of the unit to the closed position.

⚠ DANGER

Vapors from flammable liquids will explode and catch fire causing death or severe burns. Do not use or store flammable products such as gasoline, solvents or adhesives in the same room or area near the water heater.



Read and follow water heater warnings and instructions. If the owner's manual is missing, contact the retailer or manufacturer.

⚠ DANGER

1. Water temperature over 125°F (52°C) can cause severe burns instantly or death from scalds.
2. Children, disabled and elderly are at highest risk of being scalded.
3. Feel water before bathing or showering.
4. Temperature limiting valves are available. See manual.
5. To reduce the risk of scalding, install Thermostatic Mixing Valves (temperature limiting valves) at each point of use.
6. The outlet temperature of the water heater is set at 120°F (50°C). If you require water temperatures below this setting, follow the instruction manual.
7. Use this heater at your own risk. Test the water before bathing or showering. Do not leave children or an infirm person unsupervised.



A pressure relief valve listed as complying with the standard for Relief Valve and Automatic Gas Shutoff Devices for Hot Water Supply System, ANSI Z21.22 • CSA 4.4, shall be installed at the time of installation of the water heater in the location specified by the manufacturer. Local codes shall govern the installation of relief devices for safety operation of the water heater. The relief valve must not be removed or plugged.

No valve shall be placed between the relief valve and the water heater. The relief from the discharge of the pressure relief valve shall be disposed of in a suitable place where it will cause no damage. Also, there shall be no other reducing coupling or other restrictions installed on the discharge line to restrict flow.

Before operating the pressure relief valve manually, check that hot water coming out of the relief valve will discharge in a safe place to avoid contact with hot water and water damage.

See Installation Manual heading "PRESSURE RELIEF VALVES" for installation and maintenance of relief valve discharge line and other safety precautions.

NORMAL OPERATION

BUILT-IN CONTROLLER and REMOTE CONTROLLER

The illustrations below show examples of the displays of the controller. The exact display may differ from examples.

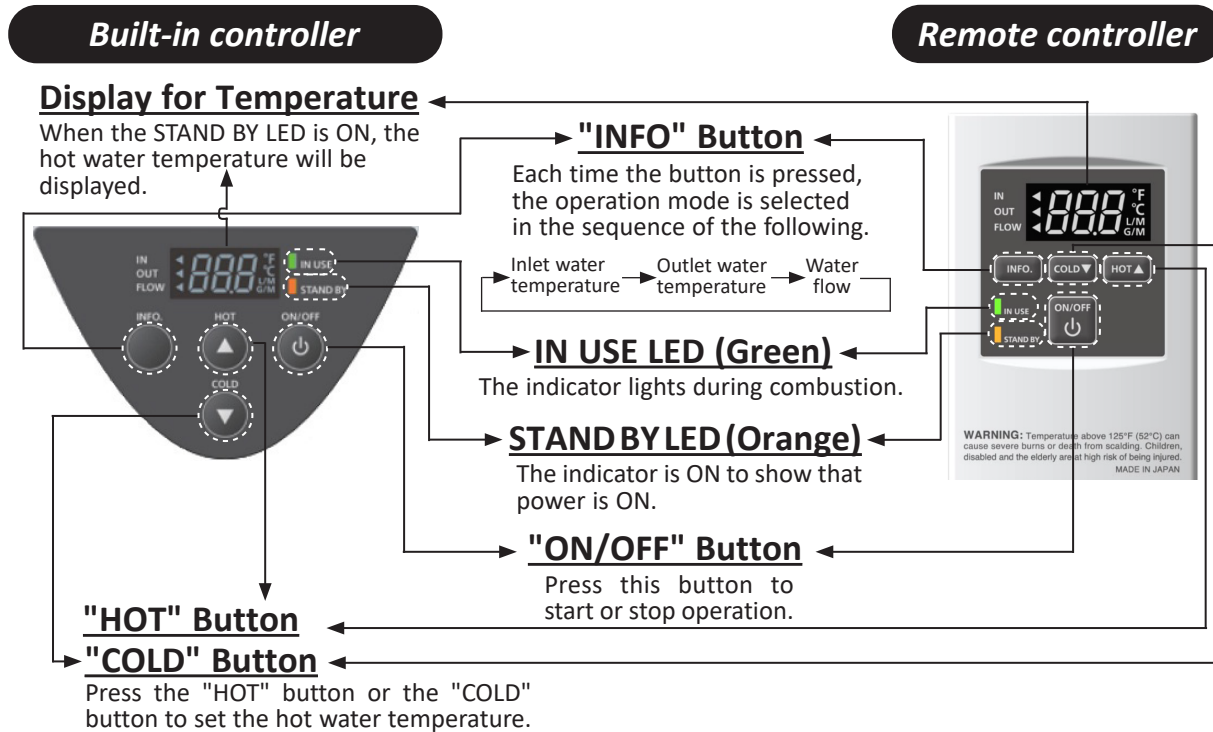

- NOTICE**
- When the remote controller is installed it will take priority over the built-in controller.
 - The controller has an energy saving mode. Five minutes after the water heater stops operating, the backlight of the controller turns off.
 - The backlight of the remote will turn back on once the water heater begins firing again.

GENERAL



WARNING

- Temperatures above 125 °F (52 °C) can cause severe burns or death from scalding. Children, disabled and the elderly are at high risk of being injured.
- To reduce the risk of scalding, install Thermostatic Mixing Valves (temperature limiting valves) at each point of use.

°F	120	125	130	135	140	145	150	155
°C	49	52	54	57	60	63	66	68
Time to produce serious burn	more than 5 min.	1½ to 2 min.	about 30 sec.	about 10 sec.	less than 5 sec.	less than 3 sec.	about 1½ sec.	about 1 sec.

1. Open a cold water fixture.

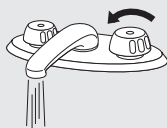

2. Mix hot water with the cold water to get the correct temperature water.

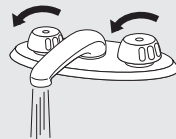













3. When finished, close the water fixtures.



- NOTICE**
- Flow rate to activate the water heater: 0.5 gallon per minute at the default set temperature (1.9 L/min).
 - Flow rate to keep the water heater running: 0.4 gallon per minute (1.5 L/min).

TEMPERATURE SETTINGS

-Set temperature-

	Operation	Screen on the controller	
		Built-in controller	Remote controller
1.	Turn on the 120 VAC power supply to the unit.		
2.	Press the "ON/OFF" button on the controller in order to turn the controller on.		
3.	When ON, the STAND BY LED is lit.		
4.	It shows the set temperature on its display as shown in the picture on the right. (EX.: 120 °F)	 (EX.: 120 °F)	
5.	Press the "HOT" button or the "COLD" button to set the temperature setting of the unit.	 	 
	<p>⚠WARNING! Higher temperatures increase the risk of scalding, but even at 120 °F (50 °C), hot water can scald (page 6).</p> <p>Increasing temperature from 120 °F (50 °C) to 125 °F (52 °C) :</p> <ol style="list-style-type: none"> 1. The water heater must be in Stand By to increase the temperature. 2. Press the "HOT" button to set 120 °F (50 °C). 3. Press and hold the "INFO" button and the "HOT" button for at least 3 seconds. The remote will emit a beep and change to 125 °F (52 °C). 4. Press the "HOT" button to set up to 140 °F (60 °C). <p>-510CX3 only-:</p> <p>Increasing temperature above 140 °F (60 °C)</p> <p>To reduce the risk of scalding, install Thermostatic Mixing Valves (temperature limiting valves) at each point of use.</p> <ol style="list-style-type: none"> 1. The water heater must be in Stand By to increase the temperature. 2. Press the "HOT" button to set 140 °F (60 °C). 3. Press and hold the "INFO" button and the "HOT" button for at least 3 seconds. The remote will emit a beep and change to 145 °F (63 °C). 4. Press the "HOT" button to set up to 160 °F (70 °C). 	 	 

TEMPERATURE TABLE OF CONTROLLER

a) 310CX3

°F	100	105	110	115	120*	125	130	135	140
°C	38	40	43	45	50*	52	55	57	60

b) 510CX3





°F	100	105	110	115	120*	125	130	135	140	145	150	155	160
°C	38	40	43	45	50*	52	55	57	60	63	65	68	70

*Factory setting (Default): 120 °F

ADDITIONAL FEATURES







-Information mode-

You can get some information about the water heater condition by pressing the "INFO" button. For more information, follow the procedures below:

INFO Button	Operation	Screen on the controller	
		Built-in controller	Remote controller
1st. press	Inlet water temperature will be displayed on the remote controller by pressing the "INFO" button.	 Inlet water temperature	
2nd. press	Outlet water temperature will be displayed on the remote controller by pressing the "INFO" button.	 Outlet water temperature	
3rd. press	Water flow will be displayed on the remote controller by pressing the "INFO" button.	 Water flow	
4th. press	Press the "INFO" button to finish information mode.		

-Unit conversion mode-

Units of measure can be changed from Imperial to Metric and vice versa. For example, temperature can be changed from °F to °C. Flow rate will also change from gallons per minute to liters per minute when this setting is changed. Follow this procedure to change this setting:

	Operation	Screen on the controller	
		Built-in controller	Remote controller
1.	Press the "ON/OFF" button on the controller in order to turn the controller on.		
2.	When ON, the orange LED is lit.		
3.	The previous set temperature will be displayed on the screen.	 (EX.: 100 °F)	
4.	Press the "INFO" buttons for at least 3 seconds.		
5.	The set temperature should now be displayed in the alternate unit of measurement.	 (EX.: 38 °C)	

TEMPERATURE SETTINGS ON THE PCB (WITHOUT CONTROLLER)



- DO NOT adjust the upper bank of DIP switches for the 510CX3 model.
- Turn off the power supply to the water heater before changing the DIP switch settings.
- Failure to observe these warnings could result in carbon monoxide poisoning, severe personal injury, or death.

- There are 2 preset temperatures, 120 °F (50 °C) and 140 °F (60 °C), that you can select by changing the DIP switch settings on the computer board without the controller. See below.
- To reduce the risk of scalding, install Thermostatic Mixing Valves (temperature limiting valves) at each point of use.
- When the controller is in normal operation, the set temperature of the controller is given priority over the set temperature of the DIP switch settings.

The temperature has been preset at the factory to 120 °F (50 °C).

310CX3

120 °F (50 °C) DEFAULT	140 °F (60 °C)
ON 1 2 3 4 5 6 7 8 9 10 OFF <input type="checkbox"/> <input type="checkbox"/> <input type="checkbox"/> <input type="checkbox"/> <input type="checkbox"/> <input type="checkbox"/> <input type="checkbox"/> <input type="checkbox"/> <input type="checkbox"/> <input checked="" type="checkbox"/>	ON 1 2 3 4 5 6 7 8 9 10 OFF <input type="checkbox"/> <input type="checkbox"/> <input type="checkbox"/> <input type="checkbox"/> <input type="checkbox"/> <input type="checkbox"/> <input type="checkbox"/> <input type="checkbox"/> <input type="checkbox"/> <input checked="" type="checkbox"/>
No. 9 : OFF	No. 9 : ON

510CX3

(Lower bank of DIP switches)

120 °F (50 °C) DEFAULT	140 °F (60 °C)
ON 1 2 3 4 5 6 OFF <input type="checkbox"/> <input type="checkbox"/> <input type="checkbox"/> <input type="checkbox"/> <input checked="" type="checkbox"/> <input type="checkbox"/>	ON 1 2 3 4 5 6 OFF <input type="checkbox"/> <input type="checkbox"/> <input type="checkbox"/> <input type="checkbox"/> <input checked="" type="checkbox"/> <input type="checkbox"/>
No. 5 : OFF	No. 5 : ON

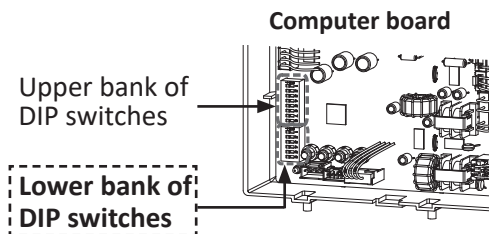
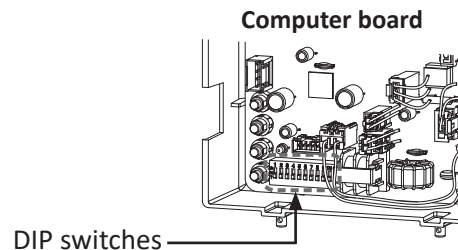

NOTE: The black square indicates the correct DIP switch position for set temperature. For the 310CX3, only adjust DIP switch No. 9. For the 510CX3, only adjust DIP switch No. 5 on the lower bank. Do not adjust the other DIP switches for temperature adjustment.

FLOW

- The flow rate through the water heater is limited to a maximum of 8.0 GPM (30 L/min) for the 310CX3, and 10.0 GPM (38 L/min) for the 510CX3.
- The temperature setting, along with the supply temperature of the water, will determine the flow rate output of the unit.
- Please refer to the temperature vs. gallons per minute charts on page 48 to determine the likely flow rates based on your local ground water temperature and your desired outlet water temperature.
- Refer to the right-hand table for typical household plumbing fixture flow rates to determine what the water heater can do in a household application.

Appliance/Use	Household Flow Rates	
	GPM (US)	L/min
Lavatory Faucet	1.0	3.8
Bath Tub	4.0 – 10.0	15.2 - 37.8
Shower	2.0	7.5
Kitchen Sink	1.5	5.6
Dishwasher	1.5	5.6
Washing machine	4.0	15.2

Taken from UPC 2006

FREEZE PROTECTION SYSTEM

- This unit comes equipped with heating blocks to protect it from damage associated with freezing. When the freeze protection thermostat/the thermo switch senses air temperature below approximately 36.5 °F (2.5 °C), the blocks will heat up to prevent freezing of the unit.
- To operate these freeze protection systems, there has to be electrical power to the unit. Damage to the heat exchanger caused by freezing temperatures due to power loss is not covered under the warranty. In cases where power losses can occur, consider the use of a backup power supply. In the event of a power outage during freezing conditions, the manufacturer recommends draining water (page 37) from the water heater and disconnecting power.
- It is the installer's responsibility to be aware of freezing issues and take all preventative measures. The manufacturer will not be responsible for any damage to the heat exchanger as a result of freezing.
- If you will not be using your heater for a long period of time or power has been lost during freezing conditions:
 1. Completely drain the water out of the unit. Refer to page 37.
 2. Disconnect power to your heater.This will keep your unit from freezing and being damaged.

NOTICE

- Only pipes within the water heater are protected by the freeze protection system. Any water pipes (hot or cold) located outside the unit will not be protected. Properly protect and insulate these pipes from freezing.
- The freeze protection system does not protect the X3™ Cartridge. Install the X3 Cartridge Anti-Freeze Kit, 100325654. Refer to page 10.

MAINTENANCE AND SERVICE



- Turn off the electrical power supply and close the manual gas shutoff valve and the manual water control valve before servicing.
- Failure to do so could result in serious personal injury or death.

- Regularly ensure that the area around the water heater, vent termination, and air intake is free from dust, debris, and other contaminants.
- Clean the cold-water inlet filter. (Refer to "Inlet water filter cleaning" on the following section.)
- Be sure that all openings for combustion and ventilation air are not blocked.
- The venting system should be checked annually for any leaks, corrosion, blockages or damage.
- The vent termination must be inspected regularly to make sure it isn't blocked by any debris, dirt, dust, snow, etc. Immediately clear any blockages.
- Keep the area around the water heater and terminations clear. Remove any combustible materials, gasoline, flammable vapors, and liquids.
- If the relief valve discharges periodically, it may be due to thermal expansion in a closed water supply system. Contact a service technician to correct this situation.
- The pressure relief valve must be manually operated periodically to check for correct operation. Before operating the valve manually, check that it will discharge in a place for secure disposal.
- The condensate drain system must be inspected regularly that it drains properly accordance with local codes or the part manufacturer's instructions if it is installed. (Refer to page 15.)
- The burner should be checked annually for dust, lint, grease or dirt.
- Visually check the burner flames (see below) through the burner window in the burner assembly located at the middle of the water heater.

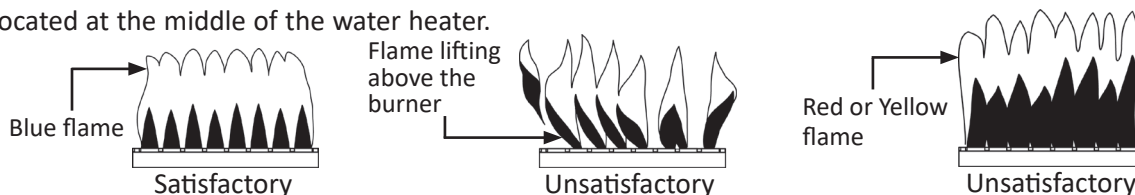

The manufacturer recommends having the unit checked once a year or as necessary by a licensed technician. If repairs are needed, any repairs should be done by a licensed technician.

INLET WATER FILTER CLEANING

If this filter is clogged, water will not be supplied to the water heater properly.

1. Close the manual gas shutoff valve.
2. Turn off power to the unit and wait a couple of seconds. Turn on again.
3. Wait 30 seconds, and then turn off power to the unit.
4. Close the **inlet** water valve.
5. Open all hot water taps in the house. When the residual water flow has ceased, close all hot water taps.
6. Have a bucket or pan to catch the water from the unit's drain plug. If Isolation valves are installed, open the drains to drain the water. If isolation valves are not installed, **unscrew** the drain plug and the pressure relief valve to drain the water out of the unit. Do not lose the o-ring that will be on the drain plug.
7. Wait a few minutes to ensure all water has completely drained from the unit.
8. **Clean the filter:** Check the water filter located within the cold inlet. With a tiny brush, clean the water filter of any debris which may have accumulated and reinsert the filter back into the cold water inlet.
9. Securely screw the drain plug back into place. **Hand-tighten only.**

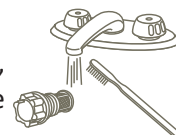
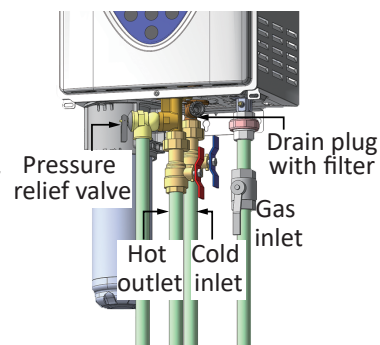

MEASURING INLET GAS PRESSURE



1. Turn off all electric power to the water heater if service is to be performed.
2. Turn the manual gas valve located on the outside of the unit to the off position.
3. Failure to follow these steps could lead to fire or explosion, resulting in personal injury or death.

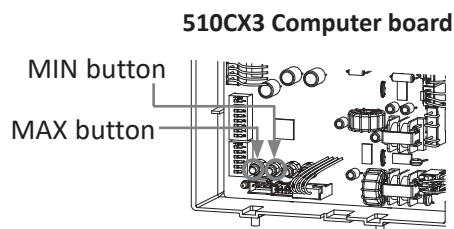
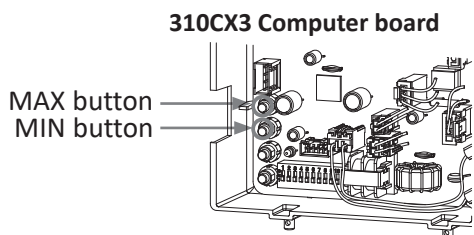

The water heater cannot perform properly without sufficient inlet gas pressure. Below are instructions on how to check the inlet gas pressure. **THIS IS ONLY TO BE DONE BY A LICENSED PROFESSIONAL.**

1. Shut off the manual gas valve on the gas supply line.
2. Remove the screw from the pressure port which is located on the gas inlet of the water heater shown in the diagram on the right.
3. Connect the manometer to the pressure port and zero the manometer.
4. Re-open the manual gas valve. Verify that there are no gas leaks.
5. With all gas burning equipment off, take a reading of the static gas pressure and make a note of it.
6. Measure gas supply pressure at maximum heater operation:
 - Remove the front cover and locate the Max/Min button on the computer board.
 - Open hot water faucets to create maximum flow.
 - Press the MAX button on the computer board. (Refer to the diagrams below.)
 - Take a reading of the supply dynamic gas pressure with all gas burning equipment running at maximum rate.
7. The static and dynamic pressures should be within the ranges specified on the heater's rating plate and the table on page 18.
8. The difference of static to dynamic pressure should not exceed 1.5" W.C. Pressure drops that exceed 1.5" W.C. can indicate restricted gas flow, undersized gas lines, and/or undersized supply regulators.
9. Measure gas supply pressure at minimum heater operation:
 - Reduce water flow so the heater is running at minimal operation.
 - Press the MIN button on the computer board. (Refer to the diagrams below.)
 - Take a supply gas pressure reading and verify that it is within the specified inlet gas pressure range. (Refer to the heater's rating plate and the table on page 18.)
10. After measuring inlet gas pressure, shut off the manual gas valve on the gas supply line and turn off the power supply.
11. Remove the manometer and replace the port screw securely. If the screw isn't fastened securely at this time, it may cause a gas leak. Verify that there are no gas leaks.
12. Replace the front cover.



UNIT DRAINING & POWER OUTAGE (FREEZE PROTECTION)

If you will not be using your heater for a long period of time, drain the water out of the unit completely and disconnect power to your heater to keep the water heater from freezing and being damaged.

1. Close the manual gas shutoff valve.
2. Turn off power to the unit and wait five (5) seconds. Turn on again.
3. Wait 30 seconds, and then turn off power to the unit.
4. Close the inlet water valve.
5. Open all hot water taps in the house. When the residual water flow has ceased, close all hot water taps.
6. Have a bucket or pan to catch the water from the unit's drain plugs. If Isolation valves are installed, open the drains to drain the water. If isolation valves are not installed, **unscrew** the drain plug and the pressure relief valve to drain the water out of the unit. Do not lose the o-ring that will be on the drain plug.
7. **Drain the X3™ Cartridge:** Have a bucket or pan to catch water from the X3™ Cartridge. To remove the X3™ Cartridge, turn it left until the  symbol aligns with the  symbol. Pull down to remove it from the water heater.
8. Drain the water in the X3™ Cartridge completely.
9. Wait a few minutes to ensure all water has completely drained from the unit.
10. Keep the cold/hot water valves closed. Keep the gas valve closed. Keep supply power disconnected.
11. Securely screw the drain plugs back into place. **Hand- tighten only.**

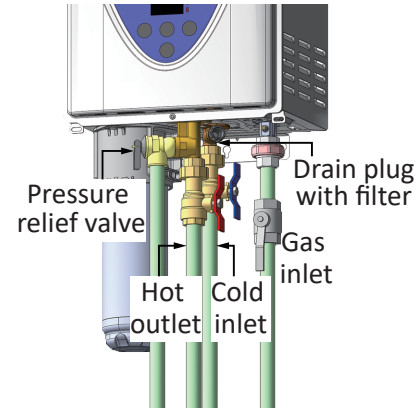

Removal of the X3™ Cartridge:

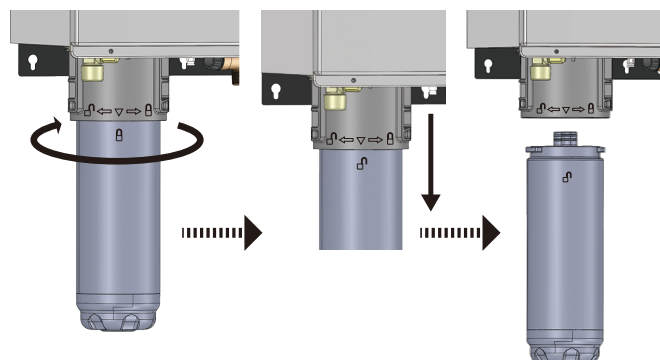

TROUBLESHOOTING

GENERAL

	PROBLEM	SOLUTIONS
TEMPERATURE and AMOUNT OF HOT WATER	It takes a long time to get hot water at the fixtures.	<ul style="list-style-type: none"> The time it takes to deliver hot water from the water heater to your fixtures depends on the length of piping between the two. The longer the distance or the bigger the pipes, the longer it will take to get hot water.
	The water is not hot enough.	<ul style="list-style-type: none"> Compare the flow and temperature. See the charts on p. 48. Check cross plumbing between cold water lines and hot water lines. Is the gas supply valve open fully? (p. 26) Is the gas line sized properly? (p. 18) Is the gas supply pressure within specified limits? (pp. 18 and 36) Is the set temperature set too low? (pp. 31 and 33) Check if the POU mixing valves are set correctly if they are installed. Check valve manufacturer's instructions for proper adjustment.
	The water is too hot.	<ul style="list-style-type: none"> Is the set temperature set too high? (pp. 31 and 33)
	The hot water is not available when a fixture is opened.	<ul style="list-style-type: none"> Make sure the unit has 120 VAC, 60 Hz power supply. Is the power button turned on? Is the gas supply valve open fully? (p. 26) Is the water supply valve open fully? (p. 26) Is the filter on the cold water inlet clean? (p. 35) Is the hot water fixture sufficiently open to draw at least 0.5 GPM (1.9 L/min) through the water heater? (p. 30) Is the unit frozen? (p. 34)
	The hot water turns cold and stays cold.	<ul style="list-style-type: none"> Is the flow rate enough to keep the water heater running? (p. 30) Is the gas supply valve open fully? (p. 26) Is the filter on the cold water inlet clean? (p. 35) Are the fixtures clean of debris and obstructions?
	Fluctuation in hot water temperature.	<ul style="list-style-type: none"> Is the filter on the cold water inlet clean? (p. 35) Is the gas line sized properly? (p. 18) Is the supply gas pressure within specified limits? (pp. 18 and 36) Check for cross connection between cold water lines and hot water lines.
WATER HEATER	Unit does not ignite when water goes through the unit.	<ul style="list-style-type: none"> Is the flow rate over 0.5 GPM (1.9 L/min)? (p. 30) Check the filter on cold water inlet. (p. 35) Check for reverse connection and cross connection. If you use the remote controller, is the power button turned on? Check if the inlet water temperature is too high. If it is too close to the set temperature, the water heater will not activate.
	The fan motor is still spinning after operation has stopped.	<ul style="list-style-type: none"> This is normal. After operation has stopped, the fan motor keeps running from 10 to 70 seconds in order to re-ignite quickly, as well as purge all the exhaust gas out of the flue.
	Unit sounds abnormal while in operation	<ul style="list-style-type: none"> Contact the manufacturer at 1-877-737-2840 (USA).

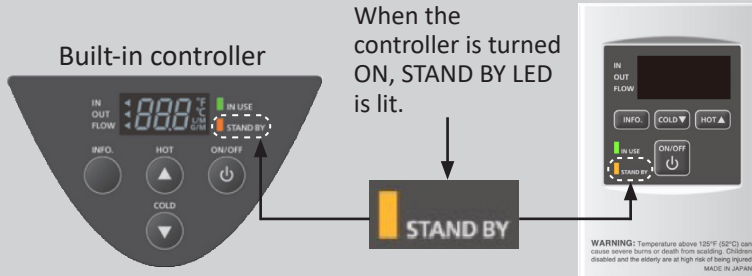
	PROBLEM	SOLUTIONS
BUILT-IN CONTROLLER and REMOTE CONTROLLER	Built-in and remote controller do not display anything when the power button is turned on.	<ul style="list-style-type: none"> • Make sure the unit is supplied with power. • For the remote controller: Make sure the connection to the unit is correct. (pp. 23 and 24)  <ul style="list-style-type: none"> • When the unit has not operated for five minutes or more, the display turns off to conserve energy.
	An ERROR code is displayed.	<ul style="list-style-type: none"> • Please see pp. 39 to 41.

ERROR CODES

-General-

- The units have self-diagnostic functions for safety and convenience when troubleshooting.
- If there is a problem with the installation or the unit, the error code will be displayed on the temperature controller and remote controller.
- Consult the table on the following pages for the description of each error code.

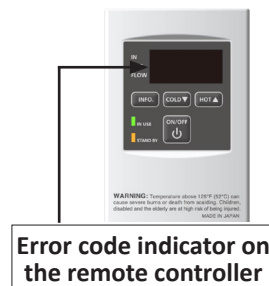

310CX3

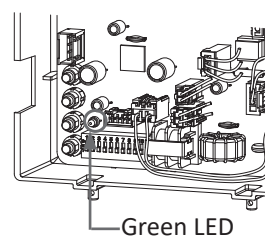

510CX3

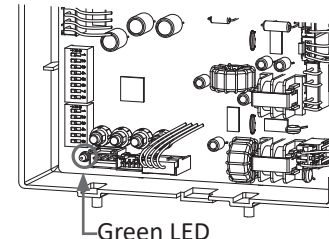

Error code on the computer board

Indicated by 1/2-second flashes on the Green LED.

Example: If your unit has the "321" error code (which signifies an inlet thermistor failure)

- **Indicator on the built-in controller and/or remote controller:** "321" will be displayed on the screen.

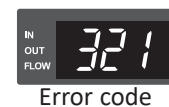

- **Green LED on the computer board:** The green LED on the computer board will indicate this code with two flashes every 1/2 second. The pattern will repeat with a three second delay between patterns.

-Fault Analysis of Error Codes-

If the error code is displayed on the computer board of the water heater or remote controller, please check the following. After checking, **consult with the manufacturer**.

Remote	Green LED	Malfunction description	Diagnosis
031	One Flash	Incorrect DIP switch setting	<ul style="list-style-type: none"> • Check the DIP switch settings on the PCB (Part #701).
101	Five Flashes	Warning for the "991" error code	<ul style="list-style-type: none"> • Check the gas type of the water heater. • Check if there is any blockage in the intake air and/or exhaust. • Check to make sure that there is enough distance between the concentric vent terminal and other exhaust vent terminals. • Check the altitude/elevation of the area where the water heater is installed. • Check if there is grease and/or dirt in the burner (Part #101) and the fan motor (Part #103), especially if the water heater has been installed in a contaminated area. • Inspect the environment around the water heater. Determine how long the unit has been installed.
111*	Three Flashes	Ignition failure	<ul style="list-style-type: none"> • Check if the Hi-limit switch (Part #412) is properly functioning. • Check for connection/breakage of wires (Part #413, 708, 709), burn marks on the computer board (Part #701), and/or soot on the flame rod (Part #108). • Check if there is a buzzing spark ignition sound coming from the burner (Part #101) when the water heater prepares for combustion. • Listen for the double "clunk" sound coming from the gas valve assembly (Part #102) when the water heater goes into combustion. • Check if there is leaking from heat exchanger (Part #401).
121*	Three Flashes	Loss of flame	<ul style="list-style-type: none"> • Check if the Hi-limit switch (Part #412) is functioning properly. • Check for connection/breakage of wires (Part #413, 708, 709), burn marks on the computer board (Part #701), and/or soot on the flame rod (Part #108). • Check if there is leaking from heat exchanger (Part #401).
311*	Two Flashes	310CX3: Outlet thermistor failure 510CX3: Heat exchanger thermistor failure	<ul style="list-style-type: none"> • Check for connection/breakage of wires and/or debris on thermistor (Part #407, 408, 411, 713).
321*	Two Flashes	Inlet thermistor failure	
331*	Two Flashes	Outlet thermistor failure (510CX3 only)	
391	Two Flashes	Air-fuel ratio rod failure	<ul style="list-style-type: none"> • Check for connection/breakage of wires (Part #709) and/or soot on the AFR rod (Part #108).

Remote	Green LED	Malfunction description	Diagnosis
510	Six Flashes	Abnormal main gas solenoid valve	<ul style="list-style-type: none"> • Check for connection/breakage of wires (Part #708) and/or burn marks on the computer board (Part #701).
551	Six Flashes	Abnormal gas solenoid valve	<ul style="list-style-type: none"> • Check for connection/breakage of wires (Part #708) and/or burn marks on the computer board (Part #701).
611*	Four Flashes	Fan motor fault	<ul style="list-style-type: none"> • Check for connection/breakage of wires, dust buildup in the fan motor (Part #103) and/or burn marks on the computer board (Part #701). • Check for frozen/corrosion of connectors (Part #103).
661*	Four Flashes	Bypass valve fault (510CX3 only)	<ul style="list-style-type: none"> • Inspect the bypass valve (Part #403), for connection/breakage of wires, locked motor drive due to scale buildup, and/or water leakage.
701*	One Flash	Computer board fault	<ul style="list-style-type: none"> • Check for connection/breakage of wires (Part #714).
711*	One Flash	Gas solenoid valve drive circuit failure	<ul style="list-style-type: none"> • Refer to the 111 and 121 error codes.
721*	Six Flashes	False flame detection	<ul style="list-style-type: none"> • Check if condensate drain is installed on the vent collar of the water heater. • Check if there is leaking from heat exchanger (Part #401).
741	N/A	Miscommunication between water heater and remote controller	<ul style="list-style-type: none"> • Check the model type of the remote controller. • Inspect the connections between the water heater and remote controller. • Check the power supply of the water heater.
751	N/A	Miscommunication between water heater and built-in controller	<ul style="list-style-type: none"> • Inspect the connections between the water heater and built-in controller. • Check the power supply of the water heater.
991	Five Flashes	Imperfect combustion	<ul style="list-style-type: none"> • Check the gas type of the water heater. • Check if there is any blockage in the intake air and/or exhaust. • Check to make sure that there is enough distance between the concentric vent terminal and other exhaust vent terminals. • Check the altitude/elevation of the area where the water heater is installed. • Check if there is grease and/or dirt in the burner (Part #101) and the fan motor (Part #103), especially if the water heater has been installed in a contaminated area. • Inspect the environment around the water heater. Determine how long the unit has been installed.

***These error codes will be cleared when water flow stops.**

COMPONENTS DIAGRAM

Case assembly

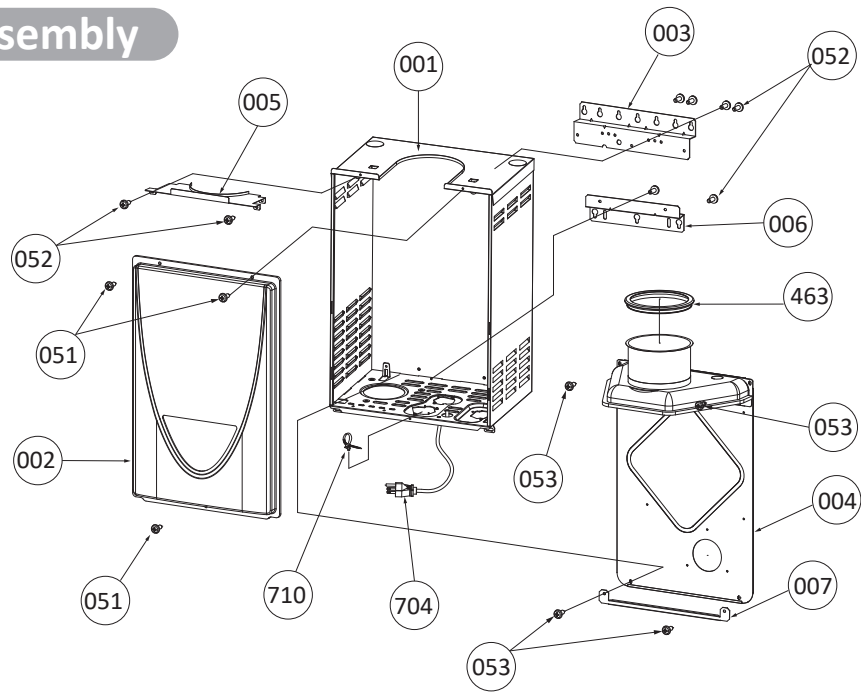

Built-in temperature controller

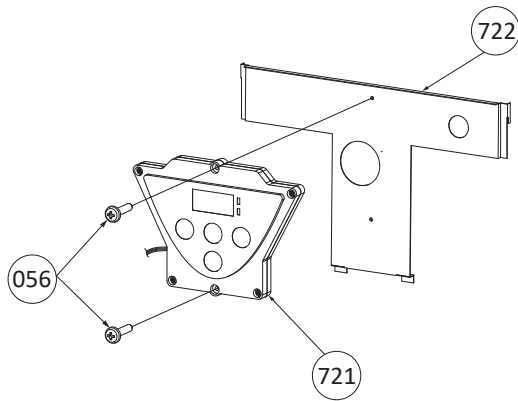

Surge box assembly

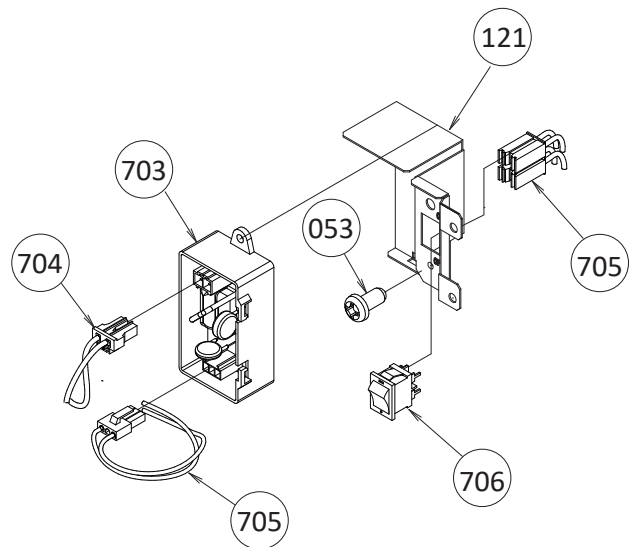

Computer board assembly

310CX3

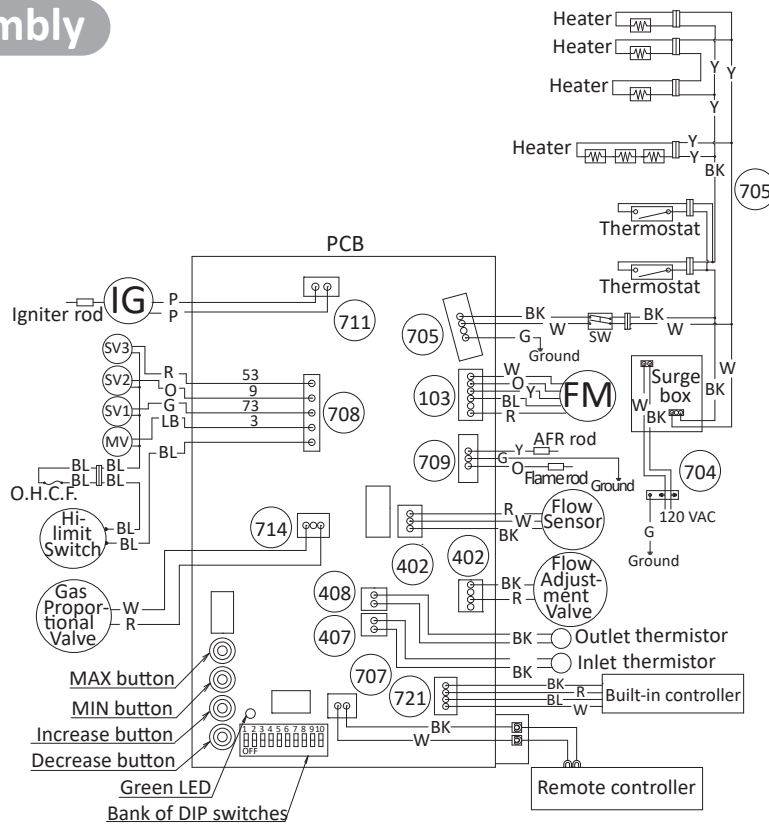
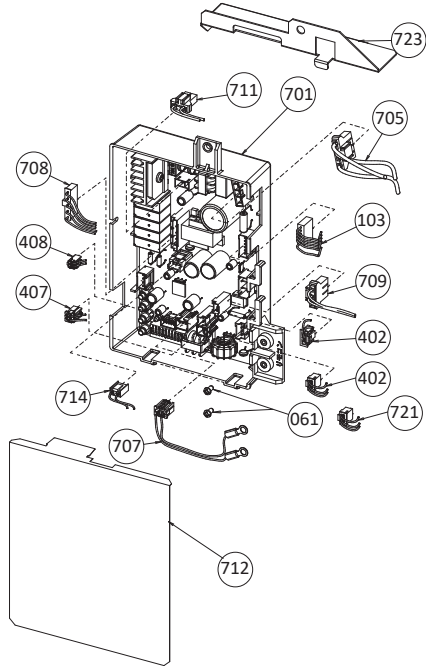

510CX3

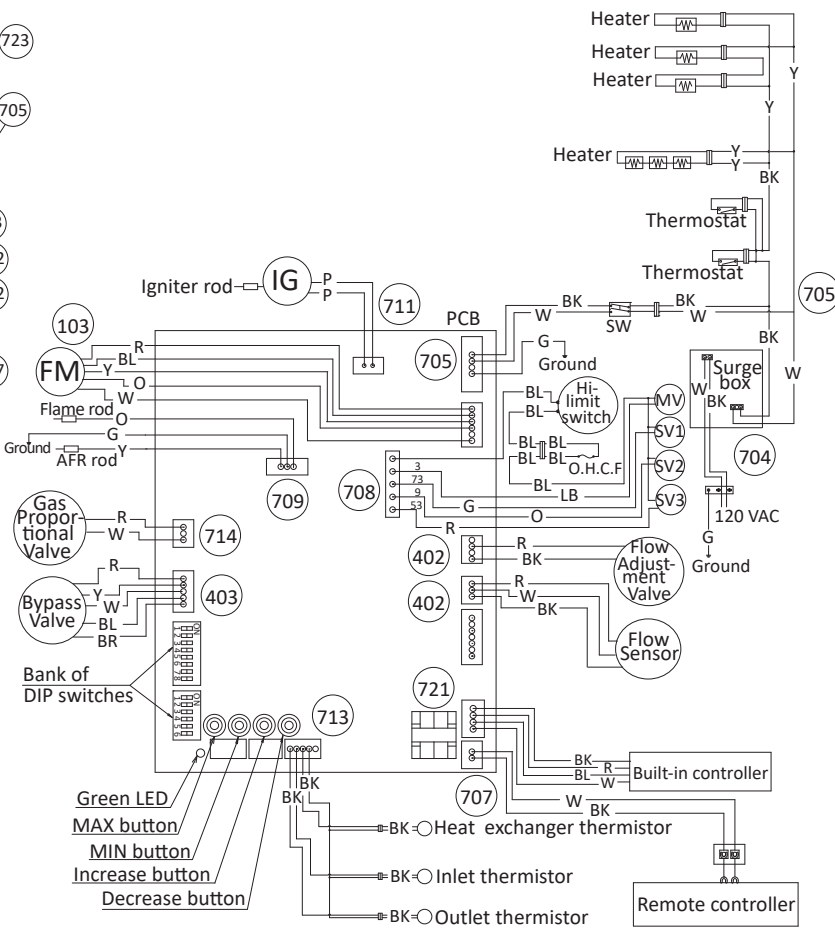
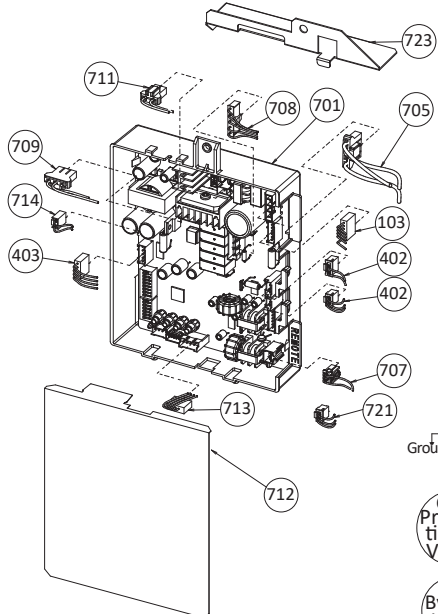

Burner assembly

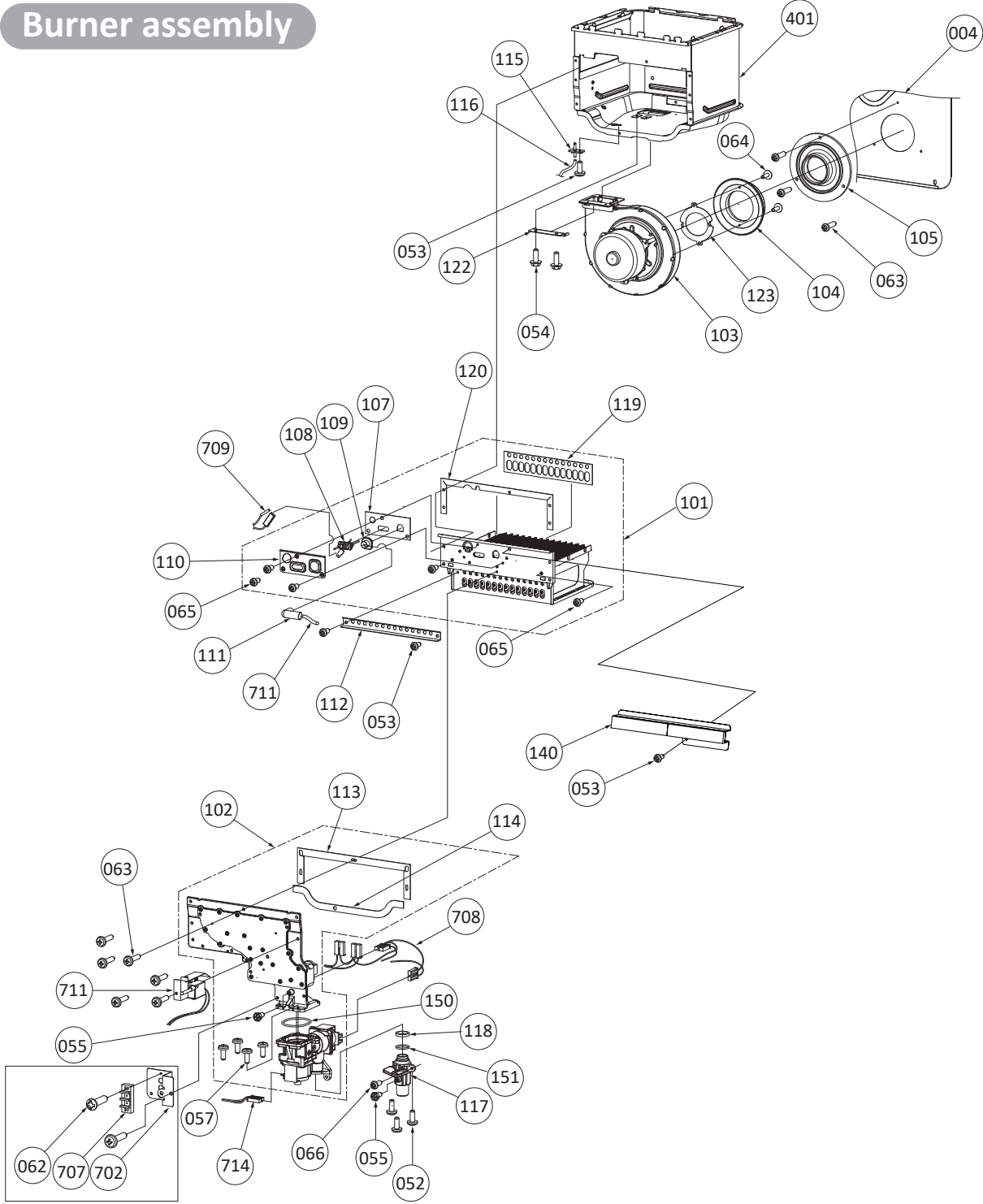

510CX3 model

LP Conversion Kit

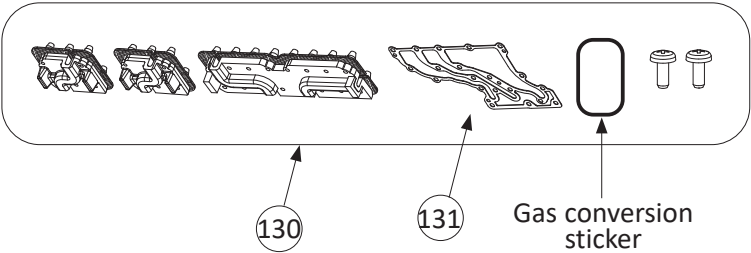

PARTS LIST

Item #	Description	Part #
001	Case assembly	N/A
002	Front cover	N/A
003	Upper bracket	N/A
004	Duct unit	N/A
005	Duct unit cover	N/A
006	Lower bracket	N/A
007	Duct unit fixing	N/A
051	Truss Screw M4×12 (W/Washer) SUS410	100074210
052	Truss Screw M4×10 (Coated) SUS3	100074211
053	Truss Screw M4x10 SUS	100074245
054	Hex head screw M4×12 (W/Washer) SUS3	N/A
055	Hex head screw M4x8 FEZN	N/A
056	Pan Screw M4x20 SUS410	N/A
057	Tap tight screw M4x12 FEZN	N/A
058	Tapping Screw M3x6 SUS3 Pan head	N/A
059	Tapping Screw M4x6 SUS3 Truss head	100074512
060	Truss Screw M4x8 SUS3	N/A
061	Screw M3x6 BSNI Binding head	N/A
062	Screw M3x12 BSNI Raised counter sunk head	N/A
063	Tapping Screw M4x14 SUS410 Truss head	100076450
064	Pan Screw M3x10 SEMS MFZN	N/A
065	Pan Screw M4x8 MFZN	N/A
066	Pan Screw M4x10 FEZN	100074247
068	Truss screw M4x12 (Coated) SUS 3	N/A
101	Burner and mixing chamber assembly	100356389
102	Manifold with gas valve assembly NA	100356403
103	Fan motor assembly	100224094
104	Fan motor gasket	100224095
105	Fan motor plate	100224096
107	Rod holder gasket	100356373
108	Flame rod with AFR function	100224098
109	Igniter rod	100224099
110	Rod holder	100356374
111	Rod cap	100076319
112	Burner damper	100224101
113	Manifold gasket A	100224102
114	Manifold gasket B	100224103
115	Pressure port	100074227
116	Combustion chamber tube	N/A
117	Gas inlet	100356404
118	Gas inlet ring	100074234
119	Burner gasket	100224105
120	Burner holder gasket	100224106
121	Surge box plate	N/A
122	Fan motor plate	N/A
123	Fan motor damper	100356375
130	LP Conversion Kit	100357126
131	Manifold Gasket	100281157
140	HX front fixing plate	N/A
150	O-ring (Manifold)	N/A
151	O-ring P20 NBR (Black)	100074242
401	Heat exchanger assembly for 310CX3 for 510CX3	100356390 100356391
402	Flow adjustment valve / Flow sensor	100356402
403	Bypass valve for 510CX3	100320466
404	Water inlet	100320526
405	Inlet drain plug	100320506
406	Inlet water filter	100320506
407	Inlet thermistor for 310CX3 Inlet thermistor for 510CX3	100356400 100356405

Item #	Description	Part #
408	Outlet thermistor for 310CX3	100356401
	Outlet thermistor for 510CX3	100356406
409	Water outlet	100320527
411	Heat exchanger thermistor for 510CX3	100320522
412	Hi-Limit switch for 310CX3	100074412
	Hi-Limit switch for 510CX3	100074280
413	Overheat-cut-off fuse	100074252
414	Pipe heater	100074682
415	Inlet heater	100074629
416	Pipe inlet for 310CX3	100356392
	Pipe inlet for 510CX3	100356393
417	Joint for 310CX3	100356394
	Joint for 510CX3	100356395
418	Thermo switch	N/A
419	Pipe outlet for 310CX3	100356396
	Pipe outlet for 510CX3	100356397
420	Flow sensor cover	N/A
421	X3™ Inlet joint	100356398
422	X3™ Inlet pipe	100356399
423	Inlet pipe heater	100348805
450	Pipe heater fixing plate	N/A
451	Heater fixing plate 16	100074310
452	Fuse fixing plate 18	N/A
453	Combustion chamber fixing plate	N/A
454	O-ring P4 FKM	100076303
456	O-ring P14 FKM	100076306
457	O-ring P15 FKM	100076307
458	O-ring P16 FKM	100076308
459	Fastener "4-11" for 510CX3	100074282
460	Fastener "14-22"	100074290
461	Fastener "16A"	100074410
462	Fastener "16-25A"	100074389
463	Silicon ring	N/A
464	HX fixing plate	N/A
465	X3™ manifold assembly	100314460
701	Computer board for 310CX3	100356386
	for 510CX3	100356387
702	Remote fixing plate for 510CX3	100074644
703	Surge box	100076100
704	120 VAC wire	100074601
705	Switch wire	100356388
706	120 VAC Power ON-OFF switch	N/A
707	Remote controller wire for 310CX3	100074649
	for 510CX3	100074650
708	Gas valve wire	N/A
709	Flame rod wire	N/A
710	Cable strap	N/A
711	Igniter assembly	100074640
712	Computer board cover	N/A
713	24V cables for 510CX3	N/A
714	Proportional gas valve wire	100074642
721	Temperature controller	100074660
722	Controller fixing plate	N/A
723	PCB fixing plate	N/A
725	X3™ cartridge	100314491

OUTPUT TEMPERATURE CHART

These charts are based on properly sized gas lines and installation at 0-2,000 ft. The water heater will de-rate approximately 4% per 1,000 ft of elevation increase above 2000 ft. To reduce the risk of scalding, install Thermostatic Mixing Valves (temperature limiting valves) at each point of use.

Output Temperature vs. GPM (Max. 8.0 GPM) with Various Inlet Water Temperature

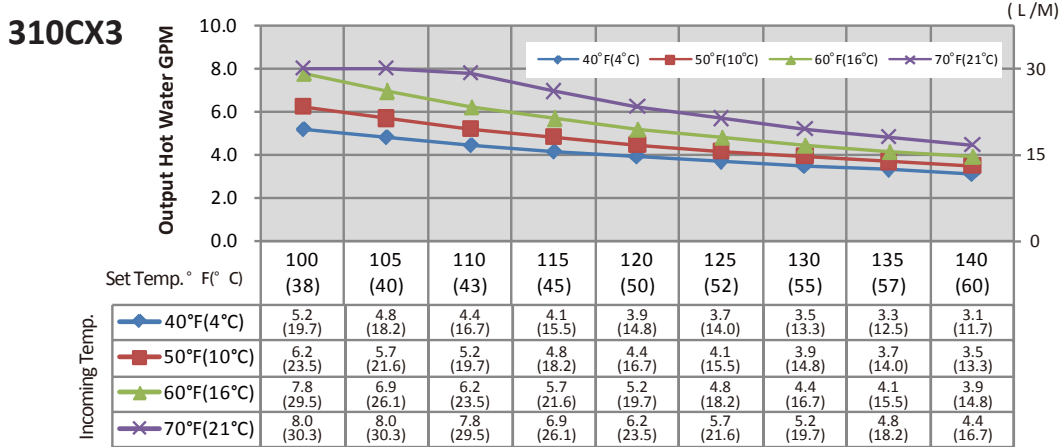

Output Temperature vs. GPM (Max. 10.0 GPM) with Various Inlet Water Temperature

