

ISSUE DATE: 03/05

**OPERATION AND MAINTENANCE MANUAL
REPLACEMENT PARTS LIST
FOR**



COLORPOINT

DIVISION OF LOW TEMP INDUSTRIES, INC.

9192 TARA BOULEVARD P.O. BOX 795 JONESBORO, GEORGIA 30237

TELEPHONE: (770) 478-8803

FIBERGLASS SERVING EQUIPMENT

ATTENTION KITCHEN MANAGER

IMPORTANT **TECHNICAL NOTICE** **REFRIGERATION AIR FILTERS**

All self contained refrigeration systems provided by Low Temp Industries are provided with a 10" x 10" x 1" air filter located at the face of the condenser directly behind the louver panel. It is important to check this filter every 30 days and replace if necessary to ensure the proper operation of the unit. Failure to check this filter and replace if clogged can and will cause premature compressor failure and will not be covered by factory warranty.

If construction is not complete when the equipment is started be sure that the filters are checked and replaced if necessary once the final clean up is completed.

The purpose for this filter is to keep the condenser fins as clean as possible. If the filter is removed and discarded the fins will become clogged or the filter is not checked and replaced the compressor works harder to maintain temperature and the box interior cabinet temperature will rise.

It is **very important** that the **MAINTENANCE PERSONNEL** be informed of this feature provided on our equipment. Your cooperation in maintaining this feature is greatly appreciated. If you have any questions or problems concerning this matter please contact Ben Shackelford or Terry Taylor in the Low Temp Engineering Department 770-478-8803.

COLORPOINT

BY LOW TEMP INDUSTRIES
JONESBORO, GEORGIA

01-05

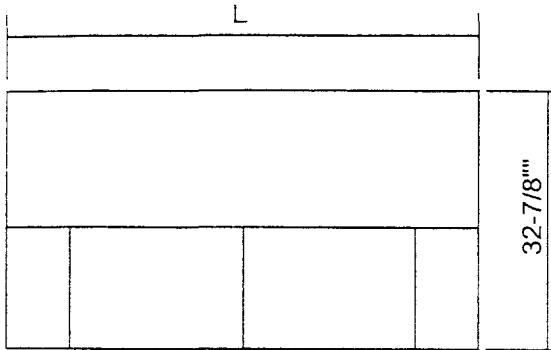

TOP VIEW

CPM-BFD SERIES FORCED AIR MILK CASE DISPENSER

THIS DESIGN MAINTAINS ITS COMPARTMENT TEMPERATURE BY THE USE OF A FAN & FINNED TUBE TYPE EVAPORATOR LOCATED INSIDE THE PRODUCT COMPARTMENT. THIS DESIGN PROVIDES A FASTER PRODUCT PULL DOWN AND RECOVERY THAN THAT PRODUCED BY SIMILAR STATIC COLD WALL DESIGNS.

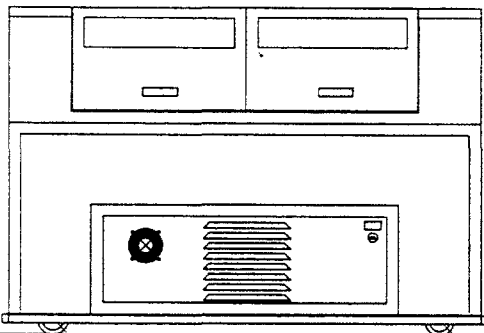

SIDE VIEW

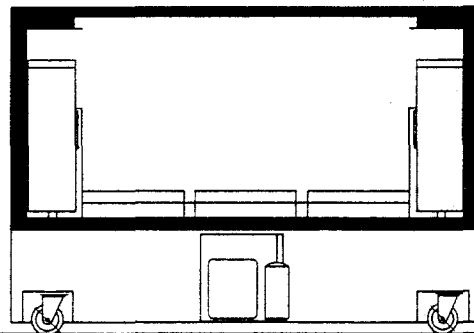

SECTIONAL VIEW

MODEL	L	NO. OF DAIRY CASES	CAPACITY USING 1/2 PT CTNS @48 PER CASE	H.P.	VOLTS	AMPS	SHIPPING WT
CPM-BFD-8	38-1/2"	8	384	1/3	120	9.6	325
CPM-BFD-12	57-1/2"	12	576	1/3	120	9.6	400
CPM-BFD-16	72-1/2"	16	768	1/2	120	11.8	475

TOP : TOP TO BE STAINLESS STEEL LINED DOUBLE WALL CONSTRUCTION INSULATED WITH URTHANE INSULATION. THE OPENING SHALL HAVE A FULL PERIMETER GASKET TO ENSURE A POSITIVE DOOR SEAL.

DOOR: DOOR TO BE BI-FOLDING MADE OF ABS PLASTIC, FULLY INSULATED WITH A PVC HINGE

BODY AND FRAME: THE EXTERIOR BODY FRAME SHALL CONSIST OF 16 GUAGE TOP, BOTTOM AND VERTICAL UPRIGHTS WITH ALL JOINTS FULLY WELDED GROUND AND POLISHED MAKING BODY FRAME ONE INTEGRAL UNIT. UNIT SHALL BE PROVIDED WITH FOUR (4) NON-MARKING CORNER BUMPERS.

REFRIGERATED DISPENSER SHALL HAVE A FULLY WELDED STEEL EXTERIOR BODY WITH A WATERTIGHT INTERIOR LINER OF STAINLESS STEEL FULLY INSULATED WITH URETHANE INSULATION COMPLETE WITH A 3/4" CONDENSATE DRAIN VALVE EXTENDED BELOW TO SHUT-OFF VALVE.

REFRIGERATION: A TEMPERATURE OF 38 DEGREES SHALL BE MAINTAINED BY FINNED TUBE FORCED AIR COILS WITH ACCESSIBLE THERMOSTATIC EXPANSION VALVE CONNECTED TO PROPERLY SIZED FULLY HERMETIC CONDENSING UNIT WITH ALL NECESSARY CONTROLS FOR PROPER OPERATION. REMOVABLE STAINLESS STEEL LOUVERED PANELS ON THE FRONT AND REAR OF UNIT ALLOW FOR PROPER VENTILATION.

CASTERS: FOUR 5" DIAMETER, BALL BEARING SWIVEL TYPE NON-MARKING CASTERS TO BE CONCEALED WITHIN THE BODY. CASTERS TO BE MOUNTED ON 12 GUAGE CHANNEL PLATES FOR MAXIMUM SUPPORT.

APPROVALS: THIS UNIT IS LISTED BY UNDERWRITERS LABORATORIES FOR SAFETY AND CLASSIFIED BY UNERWRITERS LABORATORIES FOR SANITATION UNDER NSF STD. 7 AND SHALL BEAR BOTH SEALS

******* INSPECTION *******

UPON RECEIPT, THE CRATE SHOULD BE INSPECTED FOR VISUAL DAMAGE. ANY DAMAGE SHOULD BE REPORTED IMMEDIATELY TO THE CARRIER.

******* INSTALLATION INSTRUCTIONS *******

THE COLORPOINT BFD- SERIES REFRIGERATED MILK DISPENSER IS A SELF CONTAINED UNIT FOR DISPENSING MILK. THIS UNIT IS DESIGNED TO HOLD MILK DURING A NORMAL SERVING PERIOD AT A MAXIMUM OF 40 DEGREES FAHRENHEIT. THE DESIGN OF THIS UNIT ALLOWS FOR A MODULAR OPERATION, WHERE A GROUP OF UNITS CAN BE ARRANGED TO FORM A CAFETERIA SERVING LINE. ROLL THE TABLE INTO A SERVING LINE OR OTHER NEEDED POSITION AND LOCK THE BRAKES ON THE CASTERS.

******* OPERATING INSTRUCTIONS *******

START UP:

THE REFRIGERATION SYSTEM SUPPLIED WITH THE REFRIGERATED MILK DISPENSER IS OF THE HERMETIC TYPE. REFRIGERANT IS METERED BY EXPANSION VALVES, WHICH ARE LOCATED IN EACH BLOWER COIL. EACH REFRIGERATED MILK DISPENSER IS SELF CONTAINED AND HAS BEEN LEAK TESTED, CHARGED WITH REFRIGERANT AND OPERATED TO ENSURE THE PROPER OPERATION AND SETTING OF THE CONTROLS.

ENERGIZE THE UNIT BY ATTACHING THE PLUG TO AN APPROPRIATE ELECTRICAL SUPPLY (115 VAC, 60 HZ, SINGLE PHASE, 12 AMP) AND TURNING ON THE SERVICE SWITCH LOCATED IN THE COMPRESSOR COMPARTMENT. AFTER APPROXIMATELY TWENTY-FOUR HOURS OF OPERATION THE UNIT WILL BE READY FOR USE.

OPERATION:

THE SYSTEM TEMPERATURE IS CONTROLLED BY A TEMPERATURE CONTROLLER. THE CONTROLLER IS LOCATED IN THE COMPRESSOR COMPARTMENT BEHIND THE LOUVERED PANEL. PRESSURE CONTROL (PHYSICALLY LOCATED IN THE FRONT OF THE COMPRESSOR COMPARTMENT) IS USED AS A SAFTY BACK-UP IF THE THERMOSTAT FAILS TO TURN UNIT OFF. THE LOW PRESSURE CONTROL SHOULD NOT BE ADJUSTED FROM THE FACTORY SETTINGS. ADJUSTMENT OF THIS CONTROL MAY CAUSE PERFORMANCE PROBLEMS WITH THE UNIT. THE TEMPERATURE IS DIRECTLY CONTROLLED BY THE TEMPERATURE CONTROLLER.

CLEANING:

THE OUTSIDE OF THIS UNIT IS FABRICATED FROM FIBERGLASS AND SHOULD BE CLEANED WITH A MILD NON-ABRASIVE CLEANER. NORMAL LOTION SOAP THAT IS USED IN SINKS IS SATISFACTORY.

THE INNER LINER OF THIS UNIT IS FABRICATED OF 304 STAINLESS STEEL. PLEASE SEE "HOW TO CLEAN STAINLESS STEEL" IN THIS MANUAL. NOTE THAT THIS IS A VERY BROAD SECTION ON CLEANING AND THE TYPE OF EQUIPMENT AND END USE SHOULD BE KEPT IN CONSIDERATION BEFORE SELECTING ANY SPECIAL CLEANERS.

ELECTRICAL SYSTEM:

***** WARNING *****

IN ORDER TO PREVENT ANY ELECTRICAL ACCIDENTS, THIS MILK DISPENSER SHOULD BE INSTALLED AND SERVICED BY QUALIFIED MAINTENANCE PERSONNEL ONLY PER NATIONAL ELECTRICAL CODE STANDARDS.

***** WARNING *****

INDIVIDUAL BREAKERS OR FUSES SHOULD BE PROVIDED FOR EACH COMPRESSOR MOTOR. GROUP FUSING, WHERE TWO OR MORE COMPRESSORS ARE INSTALLED ON ONE FUSE OR BREAKER IS ****NOT RECOMMENDED****. REFER TO THE NATIONAL ELECTRICAL CODE FOR APPROPRIATE LINE FUSE OR BREAKER SIZE.

HOW TO CLEAN STAINLESS STEEL

THE FOLLOWING INFORMATION WAS TAKEN FROM A PAMPHLET BY MR. RICHARD E. PARET, STAINLESS STEEL SPECIALIST, AMERICAN IRON AND STEEL INSTITUTE.

STAINLESS STEEL IS ONE OF THE EASIEST MATERIALS TO CLEAN AND KEEP CLEAN.

THE REASONS FOR STAINLESS STEEL'S EASE OF CLEANING ARE EASY TO SEE; THEY LIE IN THE NATURE OF THE METAL ITSELF.

1. Its HARD, TOUGH SURFACE. STAINLESS STEEL WILL WORK HARDER, THAT IS, THE MORE IT IS USED, THE MORE RESISTANT TO WEAR IT BECOMES. STAINLESS STEEL WILL NOT DEVELOP ROUGH SPOTS THAT HARBOR BACTERIA AND SOIL.
2. HIGH CORROSIVE RESISTANCE. STAINLESS STEEL IS PRACTICALLY UNTOUCHED BY THE CORROSIVE ATTACKS OF MOISTURE, DETERGENTS, FOOD ACIDS, BLOOD SALTS AND OTHER CORRODENTS CONNECTED WITH FOOD PREPARATION. THIS MEANS THAT STAINLESS STEEL ALWAYS HAS A BRIGHT SURFACE FREE FROM OXIDES THAT CAN AFFECT THE FLAVOR OF FOODS.

THE SECRET OF MAINTAINING STAINLESS STEEL IS FREQUENT, SCHEDULED CLEANING THAT WILL PREVENT BUILD UP OF SURFACE DEPOSITS. SURFACE DEPOSITS, IF ALLOWED TO REMAIN FOR LONG PERIODS OF TIME CAN HARM STAINLESS STEEL. STAINLESS STEEL THRIVES ON EXPOSURE TO AIR; UNDER CERTAIN CONDITIONS, THE LENGTHY DEPRIVATION OF OXYGEN BY HEAVY SOIL DEPOSITS CAN CAUSE LOCALIZED PITTING OR STAINING.

NEGLECTING THE MATERIAL IN THIS MANNER IS **DEFINITE ABUSE**, WHICH EVEN STAINLESS STEEL IS NOT IMMUNE.

TWO BASIC RULES:

1. CLEAN FREQUENTLY, AND ON A FIXED SCHEDULE.
2. SELECT THE SIMPLEST METHOD.

TO REMOVE ORDINARY DIRT AND FOOD RESIDUE FROM STAINLESS STEEL EQUIPMENT THAT OPERATES AT LOW TEMPERATURES, USE ORDINARY SOAP AND WATER AND APPLY WITH A SPONGE, FIBER BRUSH OR CLOTH. TO HASTEN ACTION, ADD SODA ASH, BAKING SODA, BORAX OR ANY OF SEVERAL NON-ABRASIVE COMMERCIAL CLEANSING AGENTS.

HOW TO CLEAN STAINLESS STEEL

(CONT.)

TO REMOVE SPLATTER OR CONDENSED VAPOR, WHICH HAVE "BAKED" ONTO THE EQUIPMENT, THE TREATMENT OUTLINED ABOVE IS OFTEN SUFFICIENT. IN OTHER CASES A GENTLE TO VIGOROUS POLISHING ACTION MAY BE NECESSARY.

FIRST TRY A PASTE MADE WITH WATER AND AMMONIA AS THE LIQUID AND EITHER MAGNESIUM OXIDE, FINELY POWDER PUMICE OR FRENCH CHALK AS THE SOLID. YOU CAN ALSO USE ONE OF SEVERAL COMMERCIAL CLEANERS LISTED IN THE FOLLOWING TABLE.

RUB AS GENTLY AS POSSIBLE IN THE DIRECTION OF THE POLISHING MARKS ON THE STEEL, USING A SOFT CLOTH. FOR MORE RESISTANT DEPOSITS, USE A STAINLESS STEEL SCOURING SPONGE OR STAINLESS STEEL WOOL OF THE FINEST POSSIBLE TEXTURE.

WHAT NOT TO DO:

DO NOT USE COMMON STEEL WOOL, SCOURING PADS, SCRAPERS, WIRE BRUSHES, FILES OR OTHER STEEL TOOLS, SINCE THESE CAN MAR THE STAINLESS STEEL. THESE PARTICLES WILL EVENTUALLY RUST AND STAIN THE SURFACE, AND YOU MAY HAVE TO REFINISH IT.

SLIGHTLY DARKENED AREAS SOMETIMES APPEAR ON STAINLESS STEEL SURFACES WHERE HEAT HAS BEEN APPLIED DURING FABRICATION OR IN SERVICE.

THESE ARE CAUSED BY THICKENING OF THE PROTECTIVE SURFACE OF STAINLESS STEEL, AND ARE NOT HARMFUL. REMOVAL CALLS FOR ENERGETIC SCOURING, AGAIN USING STAINLESS STEEL WOOL OR SCOURING PAD, COMBINED WITH A SCOURING POWDER OR ONE OF THE HEAT-TINT REMOVERS LISTED IN THE TABLE.

THREE RULES WILL PREVENT HEAT TINTING:

- 1) USE ONLY ENOUGH HEAT TO DO THE JOB EFFICIENTLY.
- 2) DO NOT APPLY HEAT TO EMPTY EQUIPMENT.
- 3) AVOID CONCENTRATING HEAT ON A SMALL AREA.

CAUTION IS ADVISED

IN STERILIZING STAINLESS STEEL EQUIPMENT, PAY PARTICULAR ATTENTION TO AGENTS CONTAINING CHLORINE COMPOUNDS SUCH AS POTASSIUM HYPOCHLORITE. THESE COMPOUNDS MAY BREAK DOWN AND RELEASE FREE CHLORINE, OR HYDROLYZE TO FORM HYDROCHLORIC ACID.

STAINLESS STEEL RESISTS ATTACK BY SUCH COMPOUNDS FOR UP TO TWO HOURS. SEVERE LOCALIZED PITTING MAY OCCUR FROM LONGER EXPOSURE. FOR SAFE USE OF THESE AGENTS, KEEP CONTACT TIME SHORT, FLUSH THOROUGHLY WITH WATER, AND OPERATE EQUIPMENT NORMALLY BETWEEN APPLICATIONS. USING THESE PRECAUTIONS, THE STERILIZATION PROCESS CAN BE REPEATED ANY NUMBER OF TIMES.

Cleaners and their effect on stainless steel

Cleaning agent	Method of Application	Effect on Finish
1. Tightly adhering deposits of "baked on" spatter, oil, grease, weather stain, dyes or other light discoloration may be removed with any of the following cleaners.		
Grade FFF Italian pumice whiting or bon ami	scour or rub with damp cloth	satisfactory for all finishes use light Pressure on no.7
Liquid NuSteel	scour with small amount on dry cloth	satisfactory for all Finishes if rubbing Pressure is light
Paste NuSteel or Temp	scour with small amount on dry cloth	satisfactory for no. 4 Finish. Will scratch no.7
Household cleaners such as Old Dutch, Sunbrite, Wyandotte, Bob-O, Gold Dust and Sapolio	Rub with damp cloth	will scratch no. 4 finish slightly
Grade F Italian Pumice	Rub with damp cloth	will scratch no.4 finish slightly
Cooper's stainless steel polishes	satisfactory	rub with damp cloth for no.4 finish
Allen stainless steel polish	Rub with damp cloth considerably	Scratches but leaves mirror reflection
Best effect chemical co. cleaner & Passivator	Rub with damp cloth	May scratch no.4 finish slightly
2. Heat tint or heavy discoloration with the following (see notes below)		
Allen stainless polish	Small amount on damp cloth	excellent heat tint remover
Birdsall's "Staybright"	Rub with damp cloth	Very good for heat tint removable. Does not scratch no.4 finish but does scratch no.7
Wyandotte or Bob-O	Rub with damp cloth heat	Good for tint removal
Oxalic acid (use warm) or 5-15% nitric acid	Swab or immerse. Always follow with a 5% sodium carbonate or neutralizer rinse	Good discoloration remover
Best effect chemical co. cleaner & Passivator	Rub with damp cloth	May scratch no 4 finish but leaves clean surface

CLEANERS AND THEIR EFFECT ON STAINLESS STEEL (Cont.)

Cleaning agent	Method of Application	Effect on Finish
<p>3. The following detergents and solvents are excellent removers of grease, oil and fatty acids, where swabbing or rubbing is not practical.</p>		
<p>4 to 6% solution of (sodium Metasilicate) (Trisodium Phosphate) (Sodium Metaphosphate) (Sodium Pyrophosphate)</p>		<p>All excellent removers of grease, oil, and milkstone</p>
<p>5-15% caustic soda (hot or cold)</p>		<p>Will remove grease and milkstone</p>
<p>4. The following organic solvents may be used for removing oils and grease deposits:</p>		
<p>Carbon-tetrachloride, Naphtha, Trichlorethylene Acetone, Kerosene, Gasoline, Ether, Alcohol, Benzene</p>		<p>No affect on finish However, take all precautions against fire.</p>

Notes: ordinary wool or steel brushes should never be used on stainless steel surfaces. Particles of steel may become imbedded in the stainless steel surface, and rusting of these particles will eventually appear as stains. Use stainless steel wool or sponge on stainless steel equipment. Heat tint removers will usually scratch stainless steel surfaces. This, however, is necessary in removing heat tint by hand. Oakite, a fibrous material, may be used in place of metal sponges or cloth pads for applying cleaners and polishes. This material is effective in aiding in removal of milkstone.

For heavy hard water deposits, 15-20% (by volume) nitric acid is very effective. Acid treatment should be followed by a thorough water rinse.

The action of soldering fluxes should be neutralized immediately with a 5% sodium carbonate solution. Soap and water followed by a water rinse will not harm stainless steel.

Preventative Maintenance of COLORPOINT Equipment

To insure that your equipment will continue to operate properly, please follow these simple steps:

- #1 Make sure that the **FILTER** in the louvered panel is always kept clean of dust and dirt. Failure to do this will cause compressor to overheat and may cause compressor failure, and will also **VOID ANY FACTORY WARRANTY** on compressor.
- #2 **MODELS CTAM, CTAL, CTAD, CPM-BFD AND CPM-FD.** To insure proper operation of these units, periodically check the evaporator unit coolers to ensure that the air intakes and the discharge areas are kept clean and clear. If the air fan intakes or discharge become blocked with wrappings or debris this will cause the coils located inside the unit coolers to freeze and the temperature in the unit will rise.
- #3 **MODELS CTAL AND CTAD.** To insure proper operation the defrost timers must be set properly. The factory recommends three (3) twenty (20) minute defrost cycles. These should be set for low peak periods. During defrost cycle the temperature indicating device will rise above the freezing point. This is normal for this system. The product temperature will not be adversely affected because this system will recover to the proper operational temperature within 15 to 30 minutes. Note: the system is provided with a two (2) indicator lights. The Green indicator shows that power switch to the system is on. The Red indicator shows that the system is in defrost. Make sure that the system has completed its defrost cycle and has proper time to recover before entering a service call. If these defrost cycles are not set properly this unit will not perform properly. An additional defrost cycle may be required if you are in a HIGH humidity environment.
- #4 **MODELS CFM, CFT AND CTAM.** Factory recommends that these units be defrosted at least once a day. Also, refer to step #1.
- #5 **MODEL CPT-R.** Refer to steps #1, and step #4
- #6 **MODELS CFMA.** When cleaning these units is important to remove the power to the circulation fan and remove it from the unit. If the fan unit becomes wet, dry the fan assembly before applying power.

For more cleaning information on these models, see the section on "CLEANING" in this manual.

REFRIGERATION SERVICE CHART

<u>COMPLAINT</u>	<u>PROBLEM</u>	<u>SOLUTION</u>
A. COMPRESSOR WILL NOT START	1. LINE DISCONNECT SWITCH OPEN 2. FUSE REMOVED OR BLOWN 3. CONTROL STUCK IN OPEN POSITION 4. CONTROL OFF DUE TO COLD LOCATION	1. CLOSE START OR DISCONNECT SWITCH 2. REPLACE FUSE 3. REPAIR OR REPLACE CONTROL 4. RELOCATE CONTROL
B. COMPRESSOR WILL NOT START, HUMS BUT TRIPS OVERLOAD PROTECTOR	1. LOW VOLTAGE TO UNIT 2. STARTING CAPACITOR DEFECTIVE 3. RELAY FAILING TO CLOSE 4. COMPRESSOR MOTOR HAS A WINDING OPEN OR SHORTED 5. INTERNAL MECHANICAL TROUBLE IN COMPRESSOR	1. CALL POWER SUPPLIER 2. REPLACE CAPACITOR 3. REPLACE RELAY 4. REPLACE COMPRESSOR 5. REPLACE COMPRESSOR
C. COMPRESSOR STARTS BUT DOES NOT SWITCH OFF OF START WINDING	1. LOW VOLTAGE TO UNIT 2. RELAY FAILING TO OPEN 3. RUN CAPACITOR DEFECTIVE 4. EXCESSIVELY HIGH DISCHARGE 5. COMPRESSOR MOTOR HAS A WINDING OPEN OR SHORTED 6. INTERNAL MECHANICAL TROUBLE IN COMPRESSOR	1. CALL POWER SUPPLIER 2. REPLACE RELAY 3. REPLACE CAPACITOR 4. CHECK DISCHARGE SHUT OVERCHARGE OR INSUFFICIENT COOLING CONDENSER. 5. REPLACE COMPRESSOR 6. REPLACE COMPRESSOR
D. COMPRESSOR STARTS AND RUNS, BUT SHORT CYCLES ON OVERLOAD PROTECTOR	1. LOW VOLTAGE TO UNIT 2. OVERLOAD PROTECTOR DEFECTIVE 3. RUN CAPACITOR DEFECTIVE 4. EXCESSIVE DISCHARGE PRESSURE 5. COMPRESSOR TOO HOT, RETURN GAS HOT 6. COMPRESSOR MOTOR HAS A WINDING SOUND	1. CALL POWER SUPPLIER 2. CHECK CURRENT, REPLACE PROTECTOR 3. REPLACE CAPACITOR 4. CHECK VENTILATION, RESTRICTIONS IN COOLING MEDIUM, RESTRICTIONS IN REFRIGERANT SYSTEM 5. CHECK REFRIGERANT CHARGE (FIX LEAK IF NECESSARY) 6. REPLACE COMPRESSOR
E. UNITS RUNS OK, BUT SHORT CYCLES ON	1. OVERLOAD PROTECTOR 2. THERMOSTAT 3. HIGH PRESSURE CUT OUT DUE TO: A. INSUFFICIENT AIR B. OVERCHARGE C. AIR IN SYSTEM 4. LOW PRESSURE CUT-OUT DUE TO:	1. SEE D-2 ABOVE 2. DIFFERENTIAL SET TOO CLOSE, WIDEN 3A. CHECK AIR SUPPLY TO CONDENSER 3B. REDUCE REFRIGERANT CHARGE 3C. PURGE

REFRIGERANT SERVICE CHART (CONT.)

<u>COMPLAINT</u>	<u>PROBLEM</u>	<u>SOLUTION</u>
	A. UNDERCHARGED	4A. FIX LEAK AND ADD REFRIGERANT
	B. EXPANSION VALVE OUT OF ADJUSTMENT.	4B. RE-ADJUST VALVE
	C. RESTRICTION IN EXPANSION VALVE.	4C. REPLACE VALVE
F. UNIT OPERATES LONG OR CONTINUOUSLY CLOSED	1. SHORTAGE OF REFRIGERANT 2. CONTROL CONTACTS STUCK OR REPLACE CONTROL 3. REFRIGERANT OR AIR CONDITIONED SPACE HAS EXCESSIVE LOAD OR POOR INSULATION 4. EVAPORATOR COIL ICED 5. RESTRICTION IN REFRIGERANT SYSTEM 6. DIRTY CONDENSER 7. FILTER DIRTY	1. FIX LEAK, ADD CHARGE 2. CLEAN CONTACTS, OR FROZEN 3. DETERMINE FAULT AND CORRECT CORRECT 4. DEFROST 5. DETERMINE LOCATION AND REMOVE 6. CLEAN CONDENSER 7. CLEAN OR REPLACE
G. START CAPACITOR OPEN	1. RELAY CONTACTS NOT OPENING PROPERLY 2. PROLONGED OPERATION ON START CYCLE DUE TO: A. LOW VOLTAGE TO UNIT B. IMPROPER RELAY 3. EXCESSIVE SHORT CYCLE	1. CLEAN CONTACTS OR REPLACE IF NECESSARY 2A. CALL POWER SUPPLIER 2B. REPLACE 3. DETERMINE REASON FOR SHORT CYCLE (SEE E. AND CORRECT)
H. RUN CAPACITOR OPEN, SHORTED OR BLOWN	1. IMPROPER CAPACITOR 2. EXCESSIVELY HIGH LINE VOLTAGE (100% OF RATED-MAX)	1. DETERMINE CORRECT SIZE AND REPLACE 2. CALL POWER SUPPLIER
I. SPACE TEMPERATURE TOO HIGH	1. CONTROL SETTING TOO HIGH 2. INADEQUATE AIR CIRCULATION	1. RESET (CONTROL) 2. IMPROVE AIR MOVEMENT
J. SUCTION LINE FROSTED OR SWEATING	1. EXPANSION VALVE STUCK 2. EVAPORATOR FAN NOT RUNNING 3. OVERCHARGE OF REFRIGERANT	1. CLEAN VALVE OF FOREIGN PARTICLES REPLACE IF NECESSARY 2. DETERMINE REASON AND CORRECT 3. CORRECT CHARGE

HOW TO ADJUST THERMOSTAT

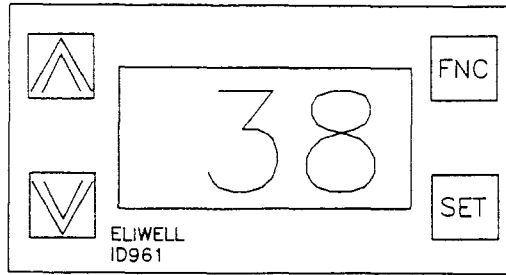

(1)

PRESS AND RELEASE SET BUTTON

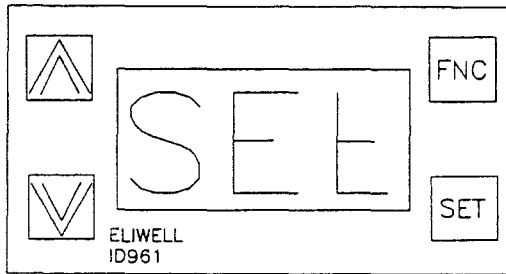

(2)

PRESS AND RELEASE SET BUTTON

(3)

PRESS UP ARROW TO RAISE TEMPERATURE

PRESS DOWN ARROW TO LOWER TEMPERATURE

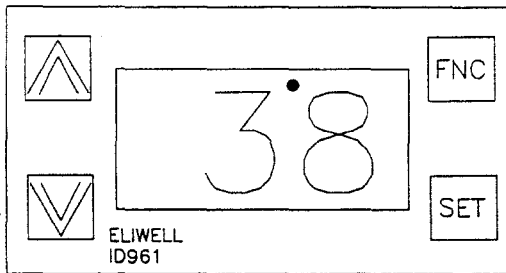

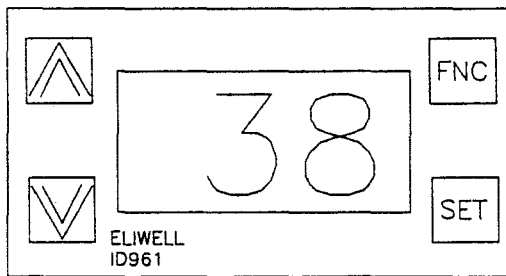

(4)

PRESS AND RELEASE FNC BUTTON TWO TIMES



IF OTHER ADJUSTMENTS ARE NEEDED PLEASE CONSULT TECHNICAL SUPPORT AT FACTORY 770-478-8803

ORDER #: DRAWN BY: T.TAYLOR REVISIONS: SCALE:	LOW TEMP MANUFACTURING <small>LOW TEMP INDUSTRIES, INC. • P.O. BOX 795 • JONESBORO, GA 30237-0795 • (770) 478-8803</small>			
	PROJECT: BFD-THERMOSTAT			
	DEALER:			
	DATE: 02-17-05	SHEET#	DWG# BFD-THERMOSTAT	

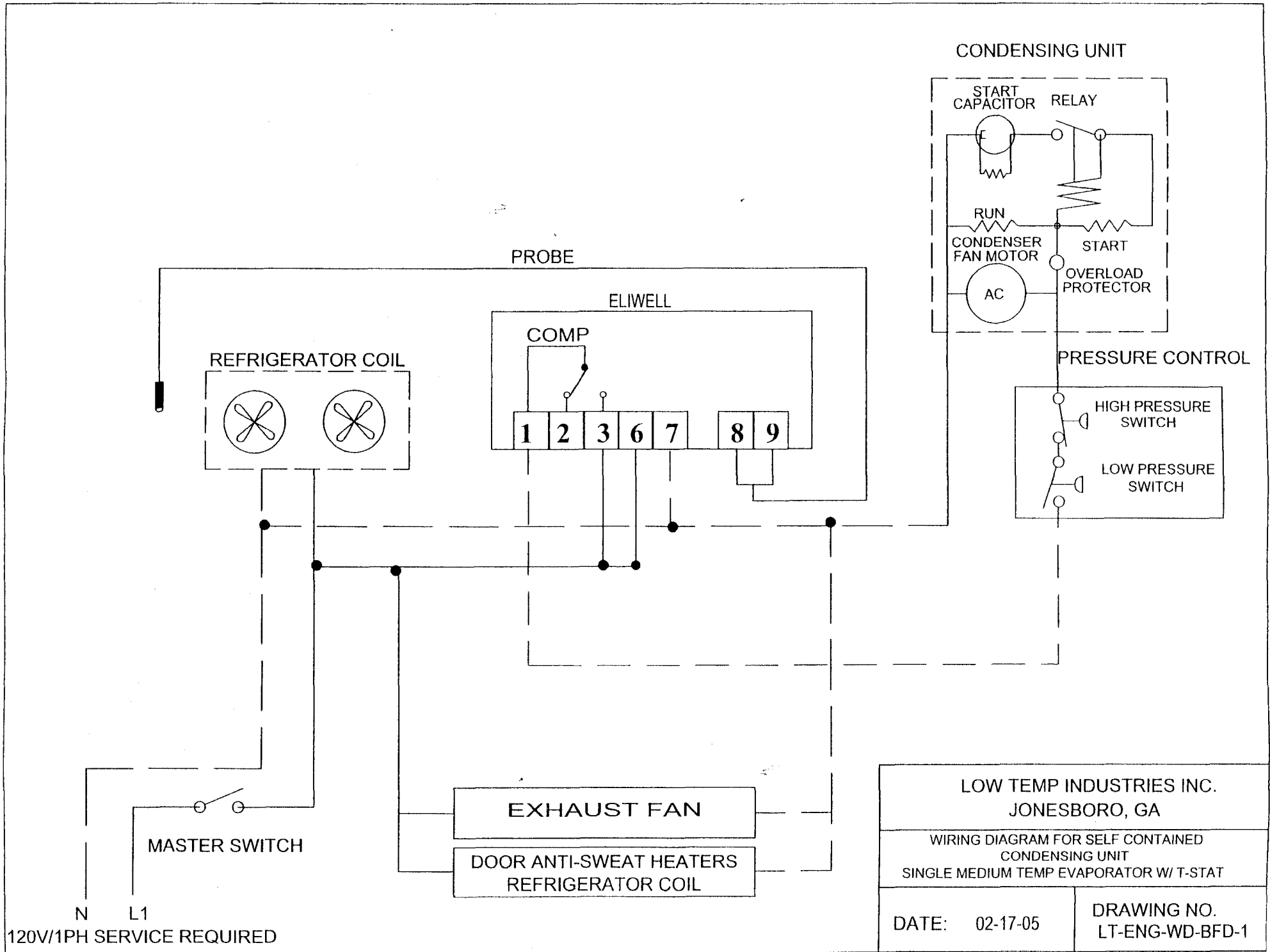

CONDENSING UNIT

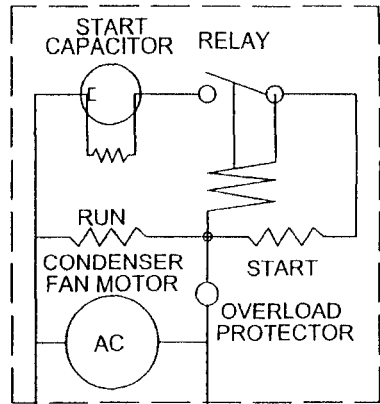

PRESSURE CONTROL

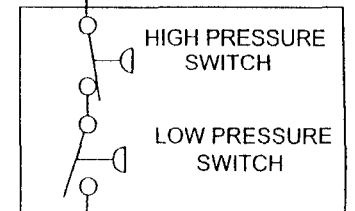

PROBE

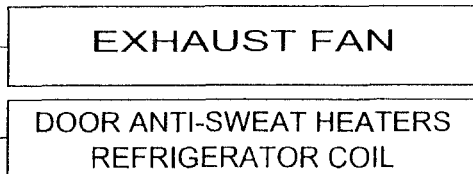
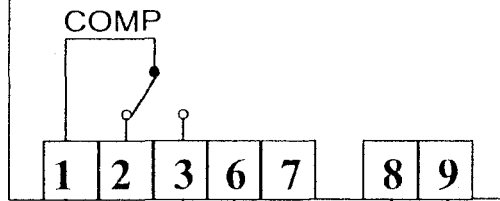
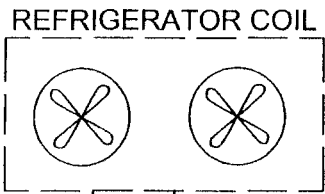
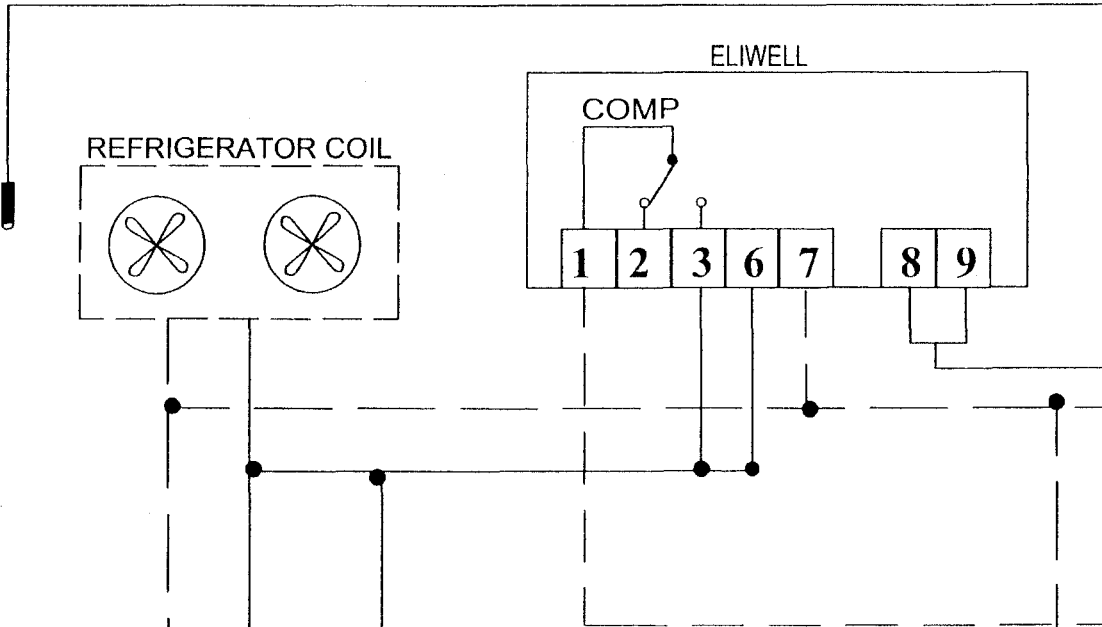

LOW TEMP INDUSTRIES INC.
JONESBORO, GA

WIRING DIAGRAM FOR SELF CONTAINED
CONDENSING UNIT
SINGLE MEDIUM TEMP EVAPORATOR W/ T-STAT

DATE: 02-17-05

DRAWING NO.
LT-ENG-WD-BFD-1

N L1
120V/1PH SERVICE REQUIRED

MASTER SWITCH

EXHAUST FAN

DOOR ANTI-SWEAT HEATERS
REFRIGERATOR COIL

ELIWELL

COMP

START CAPACITOR RELAY

RUN
CONDENSER FAN MOTOR

AC

START
OVERLOAD PROTECTOR

HIGH PRESSURE SWITCH

LOW PRESSURE SWITCH

1 2 3 6 7 8 9

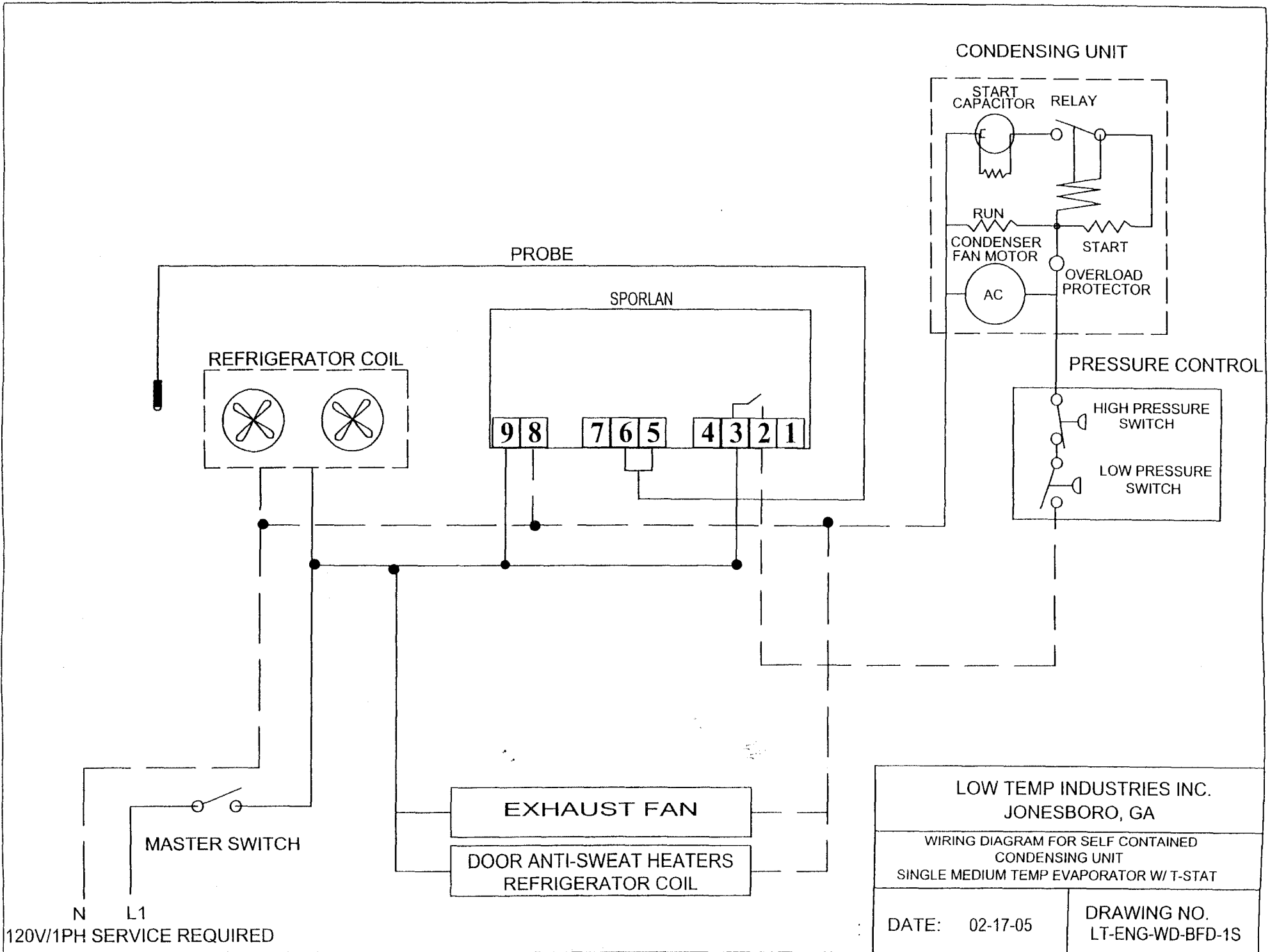

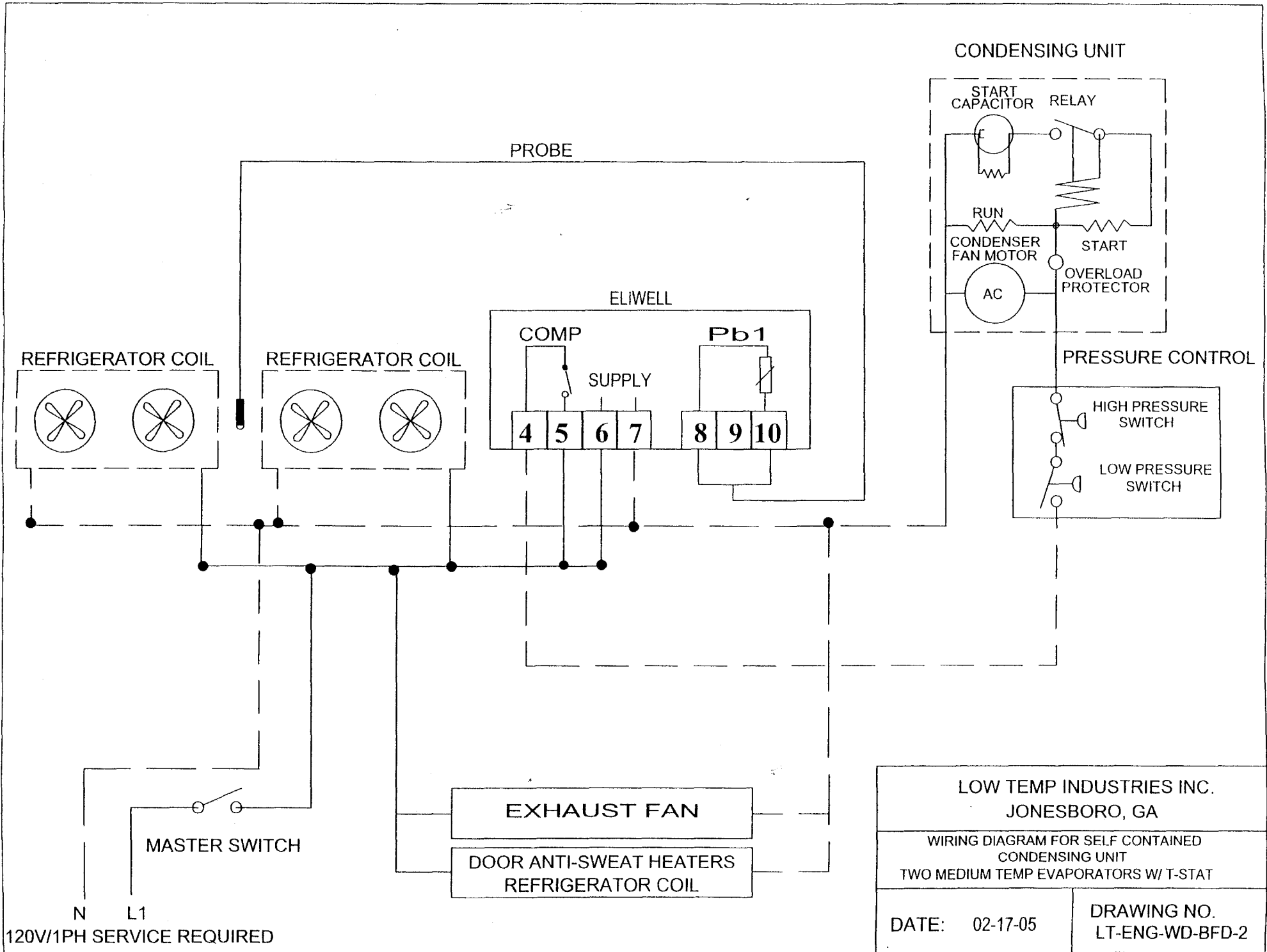

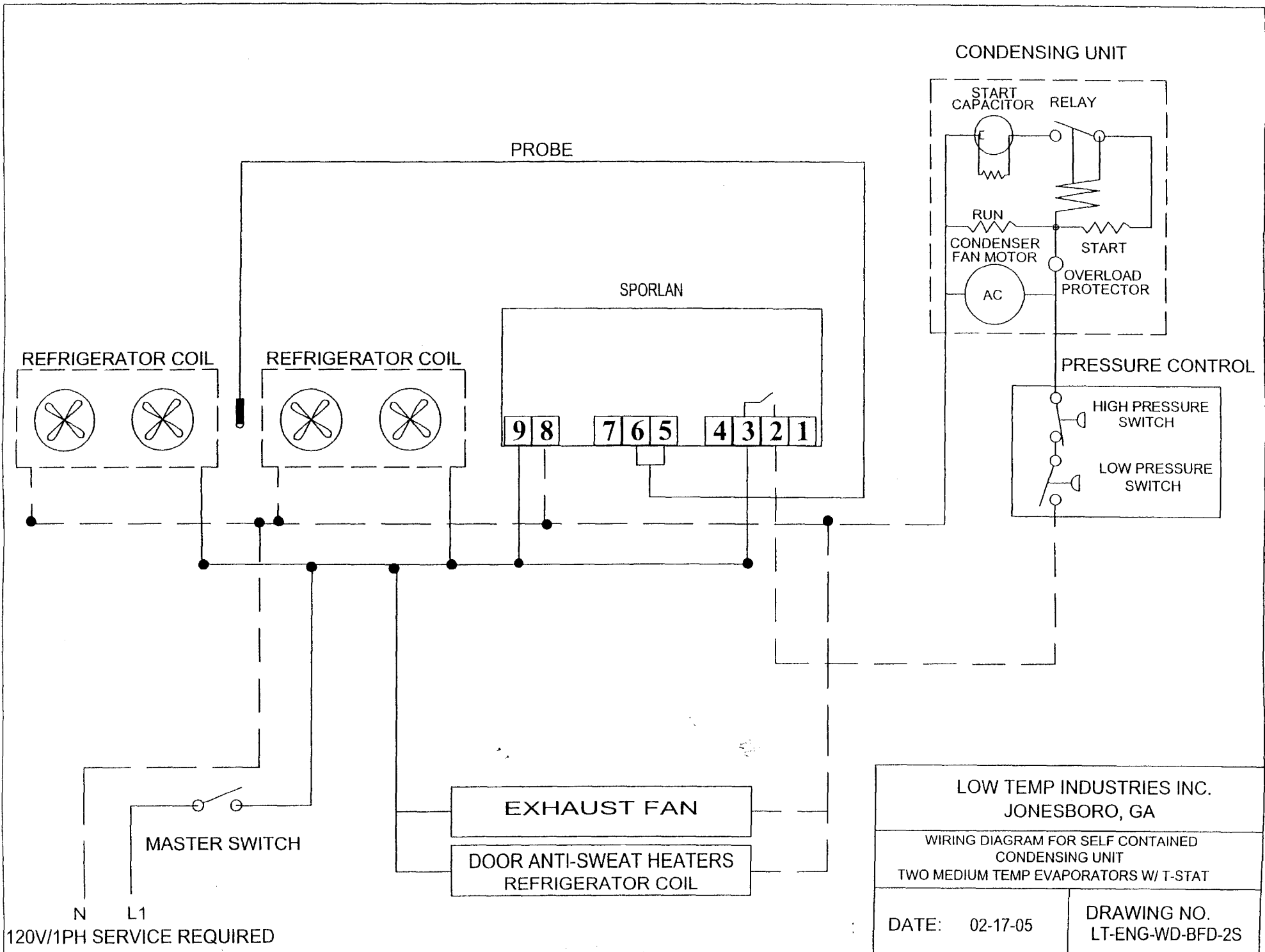

120V/1PH SERVICE REQUIRED

LOW TEMP INDUSTRIES INC. JONESBORO, GA	
WIRING DIAGRAM FOR SELF CONTAINED CONDENSING UNIT TWO MEDIUM TEMP EVAPORATORS W/ T-STAT	
DATE: 02-17-05	DRAWING NO. LT-ENG-WD-BFD-2S

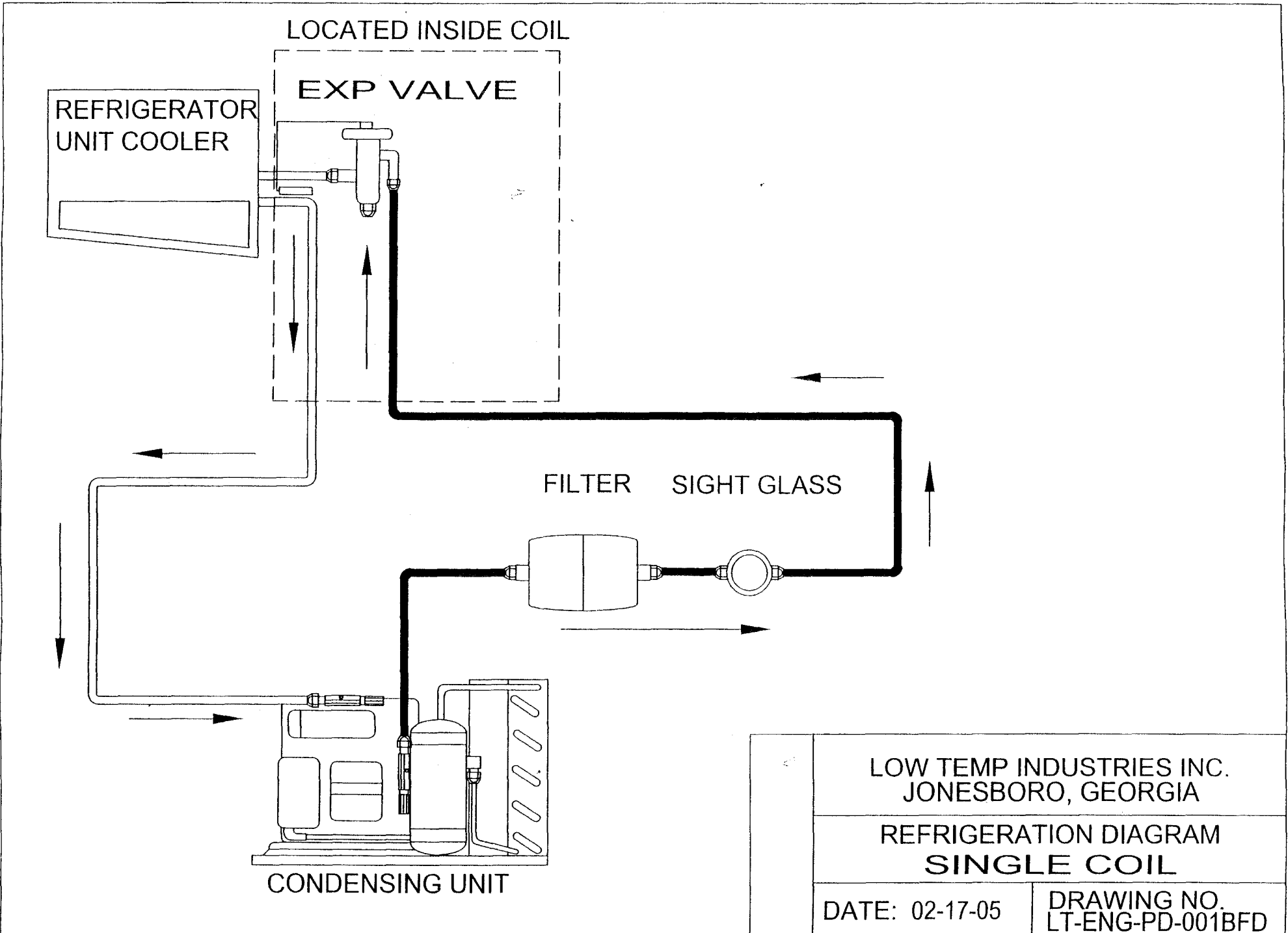

LOW TEMP INDUSTRIES INC.
 JONESBORO, GEORGIA

REFRIGERATION DIAGRAM
 SINGLE COIL

DATE: 02-17-05

DRAWING NO.
 LT-ENG-PD-001BFD

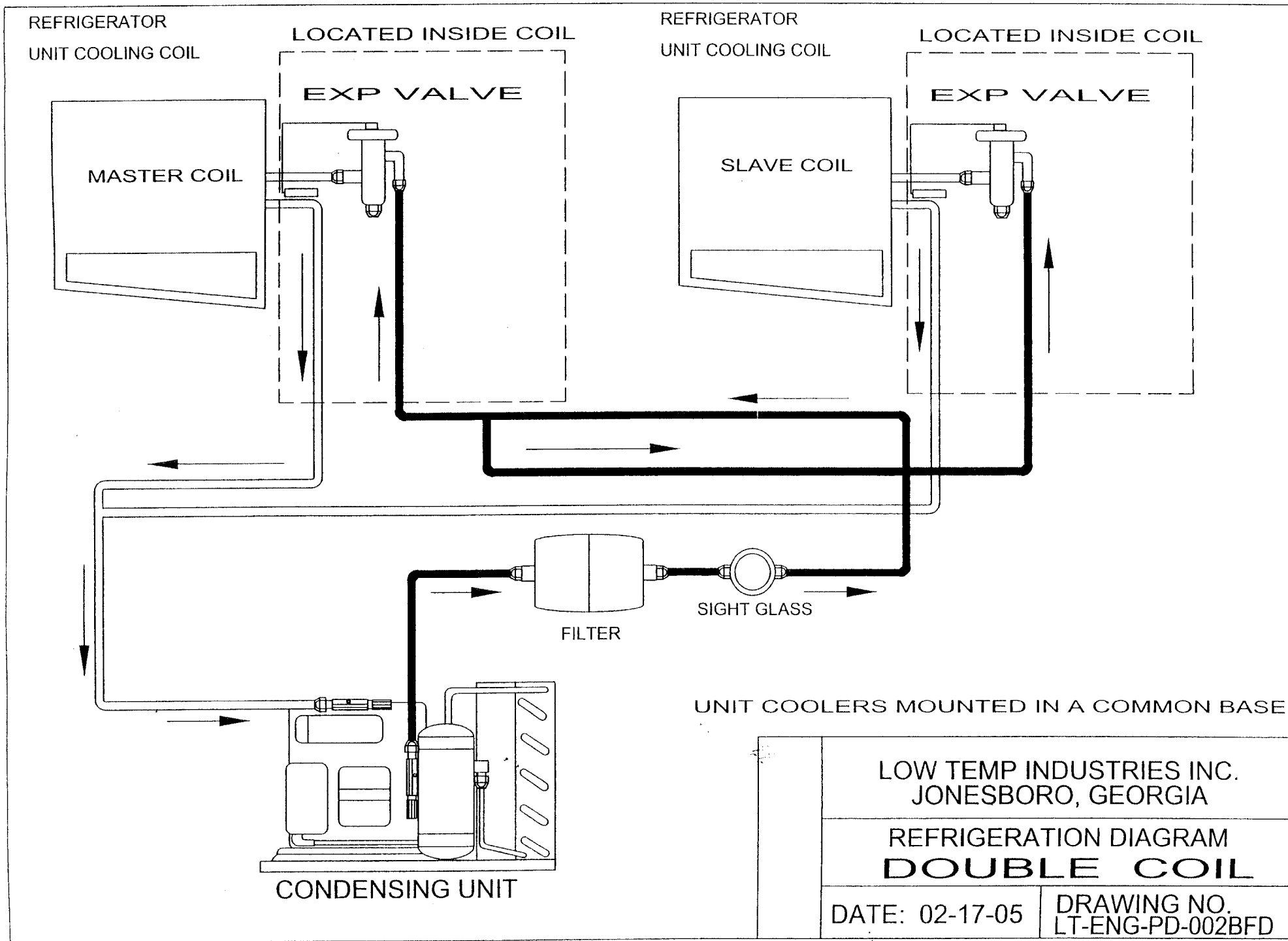

REPLACEMENT PARTS LIST
MODELS CPM-BFD-8, CPM-BFD-12 AND CPM-BFD-16
(THIS UNIT USES 134A REFRIGERANT)

ITEM NO.	DESCRIPTION	STOCK NO.	MFG. NO.	MANUFACTURER
1	CONDENSING UNIT	311929	AEA4440YXA-GC	TECUMSEH
1A	CONDENSING UNIT	311933	M2PH-0040-IAA	COPELAND
1B	CONDENSING UNIT	311943	M2PH-0047-IAA	COPELAND
2	DUAL PRESS. CONTROL	280610	012-4834-000	RANCO
3	FILTER / DRIER	282310	C-052-S-T	SPORLAN
4	SIGHT GLASS	282400	SA-12S	SPORLAN
5	EXPANSION VALVE	282577	Y1017-FJ-1/6-C	SPORLAN
6	UNIT COOLER	312035	MTW-28-13	RUSSELL
7	THERMOSTAT	280860	952869	SPORLAN
7A	THERMOSTAT	280852	ID961	ELIWELL
8	THERMOSTAT PROBE	280865	952898	SPORLAN
8A	THERMOSTAT PROBE	280851		ELIWELL
9	TOGGLE SWITCH	335900	90-0001	McGILL
10	CASTERS	131000	2-4056-43	JARVIS AND JARVIS
11	AXIAL FAN	312400	MU2A1	COMAIR ROTRON
13	KEY & CYLINDER LOCK	155640		COMPX TIMBERLINE
14	BI-FOLD DOOR	372048	BFD-8 (1 EA)	SMALL WONDER
		372046	BFD-12 (2 EA)	SMALL WONDER
		372048	BFD-16 (2 EA)	SMALL WONDER

BASIC SYSTEM OPERATION (REFRIGERATION SYSTEM)

FOLLOWING SECTION IS DESIGNED TO GIVE A BASIC WORKING KNOWLEDGE OF OUR SYSTEM. IT SHOULD NOT BE USED AS A TRAINING MANUAL FOR NON-QUALIFIED REFRIGERATION TECHNICIANS.

ALL COLORPOINT REFRIGERATED EQUIPMENT EMPLOY A COMPRESSION CYCLE SYSTEM. THERE ARE TWO PRESSURES, WHICH EXIST IN A COMPRESSION SYSTEM; THE EVAPORATING OR LOW PRESSURE, AND THE CONDENSING OR HIGH PRESSURE.

THE REFRIGERANT WORKS AS A TRANSPORTATION MEDIUM TO MOVE HEAT FROM THE EVAPORATOR TO THE CONDENSER WHERE IT IS GIVEN OFF TO THE AMBIENT AIR. THE CHANGE OF STATE FROM LIQUID TO VAPOR AND BACK ALLOWS THE REFRIGERANT TO ABSORB AND DISCHARGE LARGE QUANTITIES OF HEAT EFFICIENTLY.

THE BASIC SYSTEM OPERATES AS FOLLOWS:

HIGH PRESSURE LIQUID REFRIGERANT IS FED FROM THE RECEIVER THROUGH THE LIQUID LINE AND THROUGH THE FILTER DRIER AND SIGHT GLASS TO THE EXPANSION VALVE, WHICH WORKS AS A METERING DEVICE SEPARATING THE HIGH PRESSURE SIDE OF THE SYSTEM FROM THE LOW PRESSURE EVAPORATOR.

THE THERMOSTATIC EXPANSION VALVE CONTROLS THE FEED OF LIQUID REFRIGERANT TO THE EVAPORATOR, AND BY MEANS OF AN ORIFICE REDUCES THE PRESSURE OF THE REFRIGERANT TO THE EVAPORATING OR LOW PRESSURE SIDE.

THE REDUCTION OF PRESSURE ON THE LIQUID REFRIGERANT CAUSES IT TO BOIL OR VAPORIZE UNTIL THE REFRIGERANT IS AT THE SATURATED TEMPERATURE CORRESPONDING TO ITS PRESSURE. AS THE LOW TEMPERATURE REFRIGERANT PASSES THROUGH THE EVAPORATOR COIL, HEAT FLOWS THROUGH THE WALLS OF THE EVAPORATOR TUBING TO THE REFRIGERANT, CAUSING THE BOILING ACTION TO CONTINUE UNTIL THE REFRIGERANT IS COMPLETELY VAPORIZED.

THE EXPANSION VALVE REGULATES THE FLOW THROUGH THE EVAPORATOR AS NECESSARY TO MAINTAIN A PRESET TEMPERATURE DIFFERENCE OR SUPER HEAT BETWEEN THE EVAPORATING REFRIGERANT AND VAPOR LEAVING THE EVAPORATOR. AS THE TEMPERATURE OF THE GAS LEAVING THE EVAPORATOR VARIES THE EXPANSION VALVE POWER ELEMENT BULB SENSES ITS TEMPERATURE, AND ACTS TO MODULATE THE FEED THROUGH THE EXPANSION VALVE AS REQUIRED.

THE REFRIGERANT VAPOR LEAVING THE EVAPORATOR TRAVELS THROUGH THE SUCTION LINE TO THE COMPRESSOR INLET. THE COMPRESSOR TAKES THE LOW PRESSURE VAPOR AND COMPRESSES IT, INCREASING BOTH THE PRESSURE AND THE TEMPERATURE. THE HOT, HIGH PRESSURE GAS IS FORCED OUT THE COMPRESSOR DISCHARGE VALVE AND INTO THE CONDENSER.

AS THE HIGH PRESSURE GAS PASSES THROUGH THE CONDENSER, IT IS COOLED BY A FAN BLOWING OVER A FIN-TYPE CONDENSER SURFACE. AS THE TEMPERATURE OF THE REFRIGERANT VAPOR REACHES THE SATURATION TEMPERATURE CORRESPONDING TO THE HIGH PRESSURE IN THE CONDENSER, THE VAPOR CONDENSES INTO A LIQUID AND FLOWS BACK INTO THE RECEIVER TO REPEAT THE CYCLE.

THE REFRIGERATION PROCESS IS CONTINUED AS LONG AS THE COMPRESSOR OPERATES. THE COMPRESSOR OPERATION IS CONTROLLED BY A LOW PRESSURE CONTROL. WHEN THE REFRIGERANT VAPOR ENTERING THE SUCTION SIDE OF THE COMPRESSOR REACHES A PRESET VALUE ON THE CONTROL, IT WILL OPEN A SET OF CONTACTS AND SHUT THE COMPRESSOR OFF.

ONE YEAR WARRANTY

ALL COLORPOINT FOOD SERVICE EQUIPMENT IS FULLY WARRANTED BY THE MANUFACTURER AGAINST DEFECTS IN MATERIALS OR WORKMANSHIP FOR A PERIOD OF ONE (1) YEAR FROM THE DATE OF PURCHASE BY THE ORIGINAL USER AND ONLY TO THE ORIGINAL PURCHASER PROVIDED IT IS INSTALLED AND OPERATED IN ACCORDANCE WITH THE INSTRUCTIONS SUPPLIED WITH THE UNIT. ALSO, IT MUST NOT BE MISUSED, ALTERED OR NEGLECTED AND USED ONLY ON CIRCUITS AND VOLTAGES REQUIRED FOR THAT UNIT.

OUR OBLIGATION UNDER THIS WARRANTY SHALL BE LIMITED TO ONE OF THE FOLLOWING PROCEDURES. SELECTION OF A PROCEDURE SHALL BE AT THE SOLE DISCRETION OF LOW TEMP INDUSTRIES INC.

LOW TEMP INDUSTRIES, INC. WARRANTY SERVICE DEPARTMENT MUST BE NOTIFIED PRIOR TO ANY SERVICE WORK FOR A WARRANTY AUTHORIZATION NUMBER. ANY REQUESTS FOR WARRANTY CLAIMS WITHOUT A WARRANTY AUTHORIZATION NUMBER, WILL NOT BE HONORED

- A. REPLACEMENT OF DEFECTIVE PARTS, SHIPPED F.O.B. FACTORY, IN EXCHANGE FOR THE RETURNED DEFECTIVE PART, SHIPPED PREPAID FREIGHT.
- B. FREE REPLACEMENT OF DEFECTIVE PART, SHIPPED F.O.B. FACTORY.
- C. DEFECTIVE PART SHIPPED PREPAID FREIGHT TO FACTORY, REPAIRED AND RETURNED, SHIPPED F.O.B. FACTORY.
- D. ALL LABOR COSTS SHALL BE COVERED FOR A PERIOD OF 1 YEAR FROM THE DATE OF PURCHASE.

LOW TEMP INDUSTRIES INC. SHALL NOT BE RESPONSIBLE FOR ANY DAMAGE CAUSED BY FIRE, FLOOD, WINDSTORM, OR ANY OTHER ACT OF GOD; WAR, WHETHER DECLARED OR UNDECLARED NOR SHALL WE BE RESPONSIBLE FOR THE LOSS OF FOOD OR OTHER PRODUCTS DUE TO POWER OR MECHANICAL FAILURE. THIS WARRANTY SHALL NOT COVER ANY DAMAGE CAUSED DURING SHIPMENT, WHICH SHOULD BE REPORTED TO THE DELIVERING CARRIER.

COLORPOINT FIBERGLASS FOOD SERVICE EQUIPMENT

**A DIVISION OF LOW TEMP INDUSTRIES INC.
9192 TARA BOULEVARD
JONESBORO, GEORGIA 30236
(404) 478-8803**

FIVE YEAR COMPRESSOR WARRANTY

ALL COLORPOINT MECHANICALLY REFRIGERATED EQUIPMENT CARRIES AN EXTENDED COMPRESSOR WARRANTY BY LOW TEMP INDUSTRIES, INC.

THIS EXTENDED WARRANTY BEGINS ON THE EXPIRATION DATE OF THE ONE (1) YEAR WARRANTY BY THE COMPRESSOR MANUFACTURER AND WARRANTS THE COMPRESSOR AGAINST DEFECTS IN MATERIALS OR WORKMANSHIP FOR A PERIOD OF FOUR (4) YEARS TO THE ORIGINAL USER AND ONLY TO THE ORIGINAL PURCHASER PROVIDED IT IS INSTALLED AND OPERATED IN ACCORDANCE WITH THE INSTRUCTIONS SUPPLIED WITH THE UNIT.

THIS WARRANTY COVERS ONLY THE COMPRESSOR AND DOES NOT INCLUDE ANY RETURN SHIPPING CHARGES, OTHER TRANSPORTATION CHARGES, ANY EXTERNAL PARTS OR ELECTRICAL COMPONENTS, LABOR, REFRIGERANTS OR TAXES.

WARRANTY SHALL BE VOID IF THE UNIT HAS BEEN MISUSED, ALTERED OR NEGLECTED. THE SERIAL NUMBER SHALL NOT BE REMOVED OR DEFACED, AND THE UNIT SHALL BE USED ONLY ON CIRCUITS AND VOLTAGES REQUIRED FOR THAT UNIT.

OUR OBLIGATION UNDER THIS EXTENDED WARRANTY SHALL BE LIMITED TO ONE OF THE FOLLOWING PROCEDURES:

- A. REPLACEMENT OF DEFECTIVE COMPRESSOR, SHIPPED FREIGHT PREPAID; IN EXCHANGE FOR THE RETURNED DEFECTIVE COMPRESSOR, SHIPPED PREPAID FREIGHT.
- B. REPLACEMENT OF DEFECTIVE COMPRESSOR AT A LOCAL REFRIGERATION SUPPLY HOUSE, IN EXCHANGE FOR THE DEFECTIVE COMPRESSOR.

NO REPLACEMENT OF COMPRESSOR (S) WILL BE AUTHORIZED UNDER EXTENDED WARRANTY WITHOUT ACCURATE VERIFICATION OF SERIAL NUMBER (S) OF DEFECTIVE COMPRESSOR (S).

LOW TEMP INDUSTRIES, INC. MUST BE NOTIFIED PRIOR TO COMPRESSOR REPLACEMENT FOR A WARRANTY AUTHORIZATION NUMBER. ANY REQUESTS FOR WARRANTY CLAIMS WITHOUT A WARRANTY AUTHORIZATION NUMBER WILL NOT BE HONORED.

THIS EXTENDED WARRANTY DOES NOT COVER ANY DAMAGES CAUSED BY FIRE, FLOOD, WINDSTORM, OR ANY OTHER ACT OF GOD; WAR, WHETHER DECLARED OR UNDECLARED NOR SHALL BE RESPONSIBLE FOR THE LOSS OF FOOD OR OTHER PRODUCTS DUE TO POWER OR MECHANICAL FAILURE.

COLORPOINT FIBERGLASS FOOD SERVICE EQUIPMENT

A DIVISION OF LOW TEMP INDUSTRIES INC.

9192 TARA BOULEVARD

JONESBORO, GEORGIA 30236

(404) 478-8803