

MB MASTER-BILT®

Refrigeration Solutions



BMOA-36/36GE, 48/48GE, 74/74GE

Installation & Operations Manual

Master-Bilt Products
908 Highway 15 North
New Albany, MS 38652
Phone: (800) 684-8988

TABLE OF CONTENT

INTRODUCTION.....	3
STORE CONDITIONS / LOCATION	3
WARNING LABELS AND SAFETY INSTRUCTIONS.....	4
PRE-INSTALLATION INSTRUCTIONS.....	4
Inspection for Shipping Damage.....	4
INSTALLATION INSTRUCTIONS.....	5
General Instructions.....	5
Thermometer Installation.....	5
Plumbing.....	5
ELECTRICAL.....	6
STARTING PROCEDURE.....	6
FINAL CHECK LIST.....	6
LOADING.....	7
PLACING PRODUCT IN CABINET	7
CLEANING.....	7
ELECTRONIC TEMPERATURE CONTROL	8
Fan.....	8
Defrost.....	8
Manual Defrost	8
Alarm Signals.....	8
Setpoint.....	9
How to change parameters.....	9
List Of Parameters.....	9
ELECTRICAL CONNECTIONS.....	9
PROBE CONNECTIONS.....	9
SENSOR PROBE TEMPERATURE AND RESISTANCE.....	10
SERVICE INSTRUCTIONS (Trouble Shooting Guide).....	11
MASTER-BILT PART NUMBERS.....	12
ACCESSORIES LIST.....	12
SALE AND DISPOSAL.....	13
WIRING DIAGRAMS.....	14-16

INTRODUCTION

Thank you for purchasing a Master-Bilt cabinet. This manual contains important instructions for installing, using and servicing a Master-Bilt **BMOA** series open air case. Read all these documents carefully before installing or servicing your equipment. This manual should be left in the care of the store owner or manager.

STORE CONDITIONS / LOCATION

The Master-Bilt **BMOA** cases are designed to operate in the controlled environment of an air conditioned store. The store temperature should be at or below 75°F and a relative humidity of 55% or less. At higher temperature or humidity conditions, the performance of these cases may be affected and the capacity diminished. It is not uncommon in a newly constructed store for the temperature and humidity to be above design conditions. These excessive conditions may produce sweating in the case until the store is operational and the ambient environment is more desirable.

The Master-Bilt **BMOA** should not be positioned where it is directly exposed to rays of the sun or near a direct source of radiant heat or air flow. No HVAC return or supply air ducts may be located near case openings. This will adversely affect the case air flow and will result in poor performance. Do not open windows or doors that will affect the case air flow. The maximum air velocity near the case air return is 50 FPM. If this case is to be located against a wall there should be at least a 6" space between the wall and the back of the case. The cabinet also requires a clearance of 10" at the top. This space will allow for the circulation of air behind the case.

These cases should always be loaded properly. This unit will operate differently when loaded or unloaded. Consult the section of this manual that specifies loading procedures.

A P-trap is included with each case. It is important that each case has a P-trap installed. Consult the section of this manual for installing and piping the drain.



NOTICE

Read this manual before installing your cabinet. Keep the manual and refer to it before doing any service on the equipment. Failure to do so could result in personal injury or damage to the cabinet.



DANGER

Improper or faulty hook-up of electrical components of the refrigeration units can result in severe injury or death. All electrical wiring hook-ups must be done in accordance with all applicable local, regional or national standards.



NOTICE

Installation and service of the refrigeration and electrical components of the cabinet must be performed by a refrigeration mechanic and/or a licensed electrician.

The portion of this manual covering refrigeration and electrical components contain technical instructions intended only for persons qualified to perform refrigeration and electrical work.

This manual cannot cover every installation, use or service situation. If you need additional information, call or write us:

Customer Service Department
Master-Bilt Products
Highway 15 North
New Albany, MS 38652
Phone (800) 684-8988
Fax (800) 684-8988

WARNING LABELS AND SAFETY INSTRUCTIONS



This symbol is the safety-alert symbol. When you see this symbol on your cabinet or in this manual, be alert to the potential for personal injury or damage to your equipment.

Be sure you understand all safety messages and always follow recommended precautions and safe operating practices.



NOTICE TO EMPLOYERS

You must make sure that everyone who installs, uses or services your cabinet is thoroughly familiar with all safety information and procedures.

Important safety information is presented in this section and throughout this section and throughout the manual. The following signal words are used in the warnings and safety messages:

DANGER: Severe injury or death will occur if you ignore the message.

WARNING: Severe injury or death can occur if you ignore the message.

CAUTION: Minor injury or damage to your cabinet can occur if you ignore the message.

NOTICE: This is important installation, operation or service information. If you ignore the message, you may damage your cabinet.

The warning and safety labels shown throughout this manual are placed on your Master-Bilt Products cabinet at the factory. Follow all warning label instructions. If any warning or safety labels become lost or damaged, call your customer service department at (662) 534-9061 for replacements.

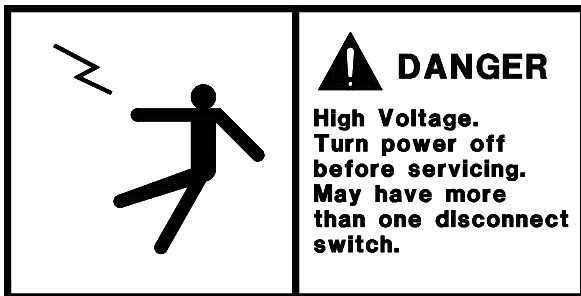

This label is located on the electrical control box and on the rear access cover.

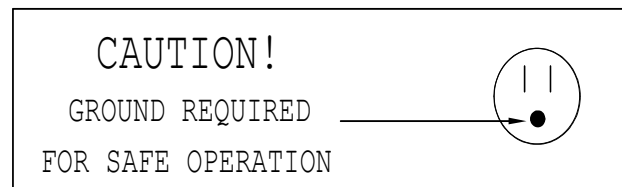

This label is attached to the cabinet power cord on models with a power cord.

PRE-INSTALLATION INSTRUCTIONS

INSPECTION FOR SHIPPING DAMAGE

You are responsible for filing all freight claims with the delivering truck line. Inspect all cartons and crates for damage as soon as they arrive. If damage is noted to shipping crates or cartons or if a shortage is found, note this on the bill of lading (all copies) prior to signing.

If damage is discovered when the cabinet is uncrated, immediately call the delivering truck line and follow up the call with a written report indicating concealed damage to your shipment. Ask for an immediate inspection of your concealed damage item. Crating material must be retained to show the inspector from the truck line.

INSTALLATION INSTRUCTIONS

GENERAL INSTRUCTIONS

1. Be sure the equipment is properly installed by competent service people.
2. Keep the equipment clean and sanitary so it will meet your local sanitation codes. Wipe up all spills, clean with water and a mild detergent, then rinse with clean water. A reservoir is provided to contain inner spills. Periodically inspect reservoir and clean as needed.
3. Rotate your stock so that older stock does not accumulate. A "First-In, First-Out" rotation practice will keep the products in good salable condition.
4. Product should not be put in the case for at least 2 hours after it is started.
5. Stock cases as quickly as possible, exposing only small quantities to store temperatures for short periods of time.
6. When replacing burned LED light bars, be sure that the electrical power to the lighting circuit is turned off.

To comply with Sanitation requirements, this cabinet must be mounted on casters, legs (6" high min.) or the base must be sealed to the floor with NSF listed silicone sealant. Minimum clearance as follows: 10" air space at top, 6" at the rear, and 0" air space at each side required for compliance. Before moving cabinet into place, route cabinet plumbing with P-trap to store drain line or install optional condensate pan.

THERMOMETER INSTALLATION

Install provided thermometer at the clip on the price tag moulding near the top left edge of the case. Remove the tape backing and press the thermometer in place.

PLUMBING

Each **BMOA** case has a P-trap installed. It is very important that this trap not be removed as it will result in diminished performance of the case without it.

1. Always install drains in accordance with local codes.
2. Use largest possible size pipe for drains, $\frac{3}{4}$ " minimum is recommended.
3. Provide as much downhill slope as possible.
4. Prevent drains from freezing. Do not install drains in contact with uninsulated suction lines.
5. If unit contain optional drain pan, Install as shown in Picture 1.



NOTICE TO STORE OWNERS / MANAGERS

Moisture or liquid around or under the cabinet is a potential slip/fall hazard for persons walking by or working in the general area of the cabinet. Any cabinet malfunction or housekeeping problem that creates a slip/fall hazard around or under the cabinet should be corrected immediately.

- *If moisture or liquid is observed around or under a Master-Bilt cabinet, an immediate investigation should be made by qualified personnel to determine the source of the moisture or liquid. The investigation made should determine if the cabinet is malfunctioning or if there is a drain pipe leaking.*

ELECTRICAL



WARNING

Before servicing electrical components in the case make sure all power to case is off. Always use a qualified technician.

STARTING PROCEDURE

1. Start compressor and allow the case to pull down to 42 degrees or below before placing product into the **BMOA**.
2. Check that the compressor cycles off and back on at least once.

FINAL CHECK LIST

- A. Check that the evaporator drain line is properly connected.
- B. All shelves are properly installed.
- C. All LED light bars are properly secure to the bottom of the shelf and plug to the cabinet's back wall.
- D. Check electrical supply voltage to make sure it is in range.
- E. All loose items and debris is removed from inside of unit and lower equipment compartment.
- F. Check condensing unit for vibrating or rubbing tubing. Dampen and clamp as required.
- G. All valves should be completely open counter-clockwise.
- H. Check packing nuts on all service valves.
- I. Replace all service valve caps and latch unit covers.
- J. Check that the temperature of the case is between 35 and 42 degrees.

LOADING

Do not place product in the case until 2 hours after it is started. Stock cases as quickly as possible, exposing only small quantities to store temperatures for short periods of time. It is important to keep stock rotated properly so that older stock does not accumulate. A "First-In, First-Out" rotation practice will keep the products in good salable condition. Avoid loading the case so that product sticks out beyond the shelves or blocking the return air grille at the bottom of the case. This will interfere with the air flow of the case and will result in diminished performance.

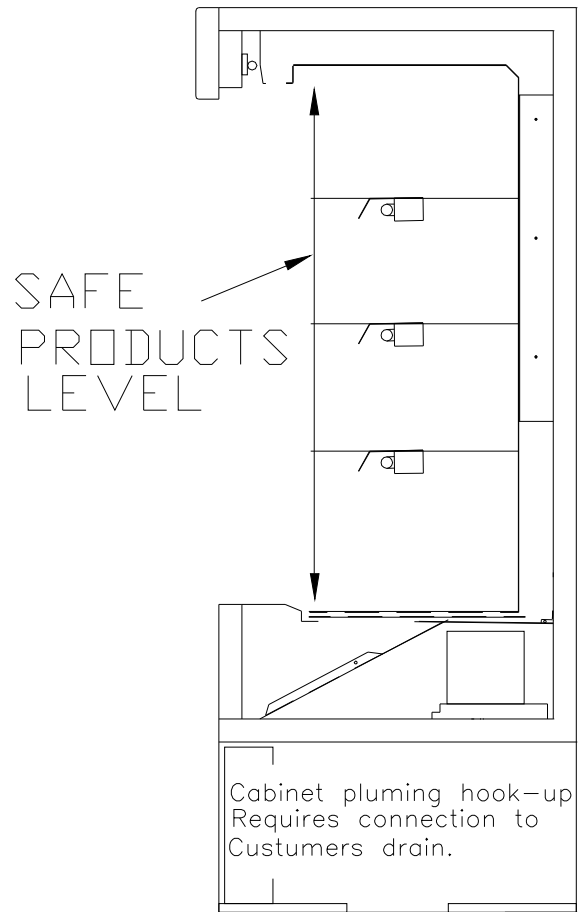

PLACING PRODUCT IN THE CABINET

Do not load the cabinet with product to the point that the air discharge grille, air intake grille, or the air curtain created by the discharge air, is blocked. The following diagram shows proper loading.

All units come with 17 ½" shelves sufficient to have 3 levels, with the optional for the fourth shelf.

CLEANING



To avoid electrical shock, turn the power off before cleaning.

The **BMOA** cabinets are designed so that spills will accumulate in a drain pan. The drain pan is located underneath the return air grill. Be sure to clean all areas with a mild detergent and water periodically.

MASTER-BILT ELECTRONIC REFRIGERATION CONTROL

DESCRIPTION



Fig.1 — Front panel

- Info / Setpoint button.
- Manual defrost / Decrease button.

INDICATIONS

- Thermostat output
- Fan output
- Auxiliary output
- Activation of 2nd parameter set
- Alarm

- Increase / manual activation button.
- Exit / Stand-by button.

OPERATION

DISPLAY

During normal operation, the display shows either the temperature measured or one of the following indications:

DEF	Defrost in progress	HI	Room high temperature alarm
REC	Recovery after defrost	LO	Room low temperature alarm
OFF	Controller in stand-by	E1	Probe T1 failure
CL	Condenser clean warning	E2	Probe T2 failure
DO	Door open alarm		

INFO MENU

The information available in this menu is:

T1	Instant probe 1 temperature	TLO	Minimum probe 1 temperature recorded
T2	Instant probe 2 temperature	CND	Compressor working weeks
THI	Maximum probe 1 temperature recorded	LOC	Keypad state lock

Compressor When power is first turned on to the control, the LED indicator under COMP on the display starts blinking. After one-minute delay the compressor comes on. The LED indicator stays on while compressor relay is energized. Display will show actual box temperature. Picture above is the display layout. The compressor will be cycled off when the actual box temperature reaches its set point. The COMP indicator will be off.





Fan The fans will run constantly during cool mode and defrost mode, or when the evaporator temp is above 55°F the FAN will be off.

Defrost The control uses time defrost with 6 defrost per day. The defrost scheme can be re-set the for special applications. During defrost the display will show dEF and the defrost LED indicator on. The control begins timing the defrost when power is turned on. Four defrost per day means it will occur every 4 hours.











MANUAL DEFROST

Defrosting may also be induced manually by keeping the defrost button for 3 seconds. Once defrost has started, the defrost will go through a defrost and drip time pull down cycle.

HOW TO CHANGE THE SETPOINT

- Press button  for at least half second, to display the setpoint value.
- By keeping button  pressed, use button  or  to set the desired value (adjustment is within the minimum **SPL** and the maximum **SPH** limit).
- When button  is released, the new value is stored.

HOW TO CHANGE a parameter value

- The setup menu is accessed by pressing button + for 5 seconds.
- With button  or  select the parameter to be modified.
- Press button  to display the value.
- By keeping button  pressed, use button  or  to set the desired value.
- When button  is released, the newly programmed value is stored and the following parameter is displayed.
- To exit from the setup, press button  or wait for 30 seconds.

LIST OF PARAMETERS

Here is a list of the parameters the value of which can be changed in the programming mode, as well as their ranges.

Display Symbol	Parameter	Range	Master-Bilt's Setting
SP	Temperature Set Point	SPL...SPH	28°F
HYS	Temperature Differential	1 to 255°F	5°
SPL	Minimum Temperature limit setpoint	-50...SPH	25°F
SPH	Maximum Temperature limit setpoint	SPH...120°	40°F
AHA	High Temperature alarm	-50...120°	65°F
ALA	Low Temperature Alarm	50...120°	0°F
ATD	Temperature Alarm Delay	0...120min	30min
DFR	Number of Defrost Cycle per 24hr	0...24	6/day
DLI	Defrost Termination Temperature	-50...120°	40°F
DTO	Maximum Defrost Duration	1...120min	15min

ELECTRICAL CONNECTIONS

The controller is provided with screw/push terminal block to connect cables with a cross section up to 2,5 mm². Before connecting cables make sure the power supply complies with the control's requirements. Separate the probe cables from the power supply cables, from the outputs and the power connections. Do not exceed the maximum current allowed on each relay, in case of heavier loads use a suitable external relay or contactor's.

PROBE CONNECTIONS

The probes shall be mounted with the bulb upwards to prevent damages due to casual liquid infiltration. It is recommended to place the thermostat probe away from air streams to correctly measure the average room temperature. Place the defrost termination probe among the evaporator fins in the coldest place, where most ice is formed, far from heaters or from the warmest place during defrost, to prevent premature defrost termination.

SENSOR PROBE TEMPERATURE AND RESISTANCE
NTC10K Temperature-Resistance

Temp (°C)	Temp (°F)	R-low (Kohm)	R-center (Kohm)	R-high (Kohm)
-40	-40	188.021	195.652	203.573
-35	-31	142.788	148.171	153.741
-30	-22	109.522	113.347	117.294
-25	-13	84.823	87.559	90.374
-20	-4	66.270	68.237	70.255
-15	5	52.229	53.650	55.104
-10	14	41.477	42.506	43.557
-5	23	33.147	33.892	34.651
0	32	26.678	27.219	27.767
5	41	21.630	22.021	22.417
10	50	17.643	17.926	18.210
15	59	14.472	14.674	14.877
20	68	11.938	12.081	12.224
25	77	9.900	10.000	10.100
30	86	8.217	8.315	8.413
35	95	6.854	6.948	7.043
40	104	5.745	5.834	5.923
45	113	4.834	4.917	5.001
50	122	4.084	4.161	4.239
55	131	3.464	3.535	3.607
60	140	2.949	3.014	3.081
65	149	2.526	2.586	2.647
70	158	2.173	2.228	2.283
75	167	1.875	1.925	1.976
80	176	1.623	1.669	1.715
85	185	1.411	1.452	1.495
90	194	1.230	1.268	1.307
95	203	1.075	1.110	1.145
100	212	0.942	0.974	1.006
105	221	0.829	0.858	0.888
110	230	0.732	0.758	0.785
115	239	0.647	0.671	0.696
120	248	0.574	0.596	0.619
125	257	0.511	0.531	0.552

SERVICE INSTRUCTIONS (Trouble Shooting Guide)

1. High head pressure and high back pressure:
 - A. Condenser coil clogged or restricted.
 - B. Condenser fan motor defective.
2. Low back pressure and low head pressure:
 - A. Restriction in system.
 - B. Refrigerant undercharged.
 - C. Leak in system.
3. Pressures normal – cabinet warm:
 - A. Coil blocked with frost or ice.
 - B. Control set too warm.
 - C. Air screen disturbance.
4. Coil blocked with frost or ice:
 - A. Defective temperature contro
 - B. Defective or disconnected coil sensor.
 - C. Improper control setting.
 - D. Ambient conditions above **75°F**
 - E. P-trap in train not installed.
 - F. Evaporator fan motor defective.
 - G. Air screen disturbance.
5. Compressor starts and runs – but cycles on overload:
 - A. Low voltage.
 - B. Dropped phase (3 phase).
 - C. Overload protector defective.
 - D. High head pressure (see#1).
 - E. Relay or Capacitor defective.
6. Compressor will not start – hums, but cycles on overload.
 - A. Low voltage.
 - B. Relay defective.
 - C. Overload protector defective.
 - D. Start capacitor defective.
 - E. High head pressure (see #1)

MASTER-BILT PART NUMBERS

The table below gives Master-Bilt part numbers. Use this chart when ordering replacement parts for your **BMOA** cases.

All quantities are one each unless otherwise noted by parentheses.

Description	BMOA-36	BMOA-48	BMOA-74
Compressor	03-15217	03-15211	03-14480
Condenser Coil	07-13226	07-13195	07-13197
Condenser Fan Blade	15-13097	15-13081	15-13090
Condenser Fan Motor	13-01283	13-13121	13-13121
Contactora	19-13934	19-13934	19-13934
Drier	09-09711	09-09711	09-09711
Evaporator Coil	07-13225	07-13188	07-13186
Evaporator Fan Blade	15-13106	15-13106	15-13106
Evaporator Fan Motor	13-13182	13-13182	13-13182
Electronic Controller	19-14242	19-14242	19-14242
Box Sensor T1	19-14244	19-14244	13-14244
Evaporator Sensor T2	19-14245	19-14245	19-14245
Expansion Valve	09-09553	09-09553	09-09553
Female Plug	21-00568	21-00568	21-00568
LED Driver (Convertor)	23-01765	23-01765	23-01765
LED Light Bar End Caps	23-01761	23-01761	23-01761
LED Light Bar Power Cord	23-01762	23-01762	23-01762
LED Light Bar, 24"	23-01764	-	23-01764
LED Light Bar, 36"	-	23-01763	-
Light Switch	19-01071	19-01071	19-01071
Thermometer	19-14252	19-14252	19-14252
Refrigerant (R-404a)	30 oz.	64 oz.	90oz.

ACCESSORIES LIST

Description	BMOA-36	BMOA-48	BMOA-74
Extra Shelves			
Lighted Shelf (White)	A077-600WL	A078-600WL	A079-600WL
Lighted Shelf (Black)	A077-600BL	A078-600BL	A079-600BL
Non-Lighted Shelf (White)	A077-600WN	A078-600WN	A079-600WN
Non-Lighted Shelf (Black)	A077-600BN	A078-600BN	A079-600BN
Condensate Removal			
Condensate Pump	61-00529	61-00529	61-00529
Condensate Pan	17-09287	17-09264	17-09264
Casters			
2" Diameter	(4) 27-50045	(4) 27-50045	(6) 27-50045

SALE AND DISPOSAL

OWNER RESPONSIBILITY

If you sell or give away your Master-Bilt cabinet you must make sure that all safety labels and the Installation - Service Manual are included with it. If you need replacement labels or manuals, Master-Bilt will provide them free. Contact the customer service department at Master-Bilt at (800) 684-8988.

The customer service department at Master-Bilt should be contacted at the time of sale or disposal of your cabinet so records may be kept of its new location.

If you sell or give away your Master-Bilt cabinet and you evacuate the refrigerant charge before shipment, Master-Bilt recommends that the refrigerant charge be properly recovered in compliance with section 608 of the Clean Air Act effective November 1995 and in accordance with all applicable local, regional, or national standards.

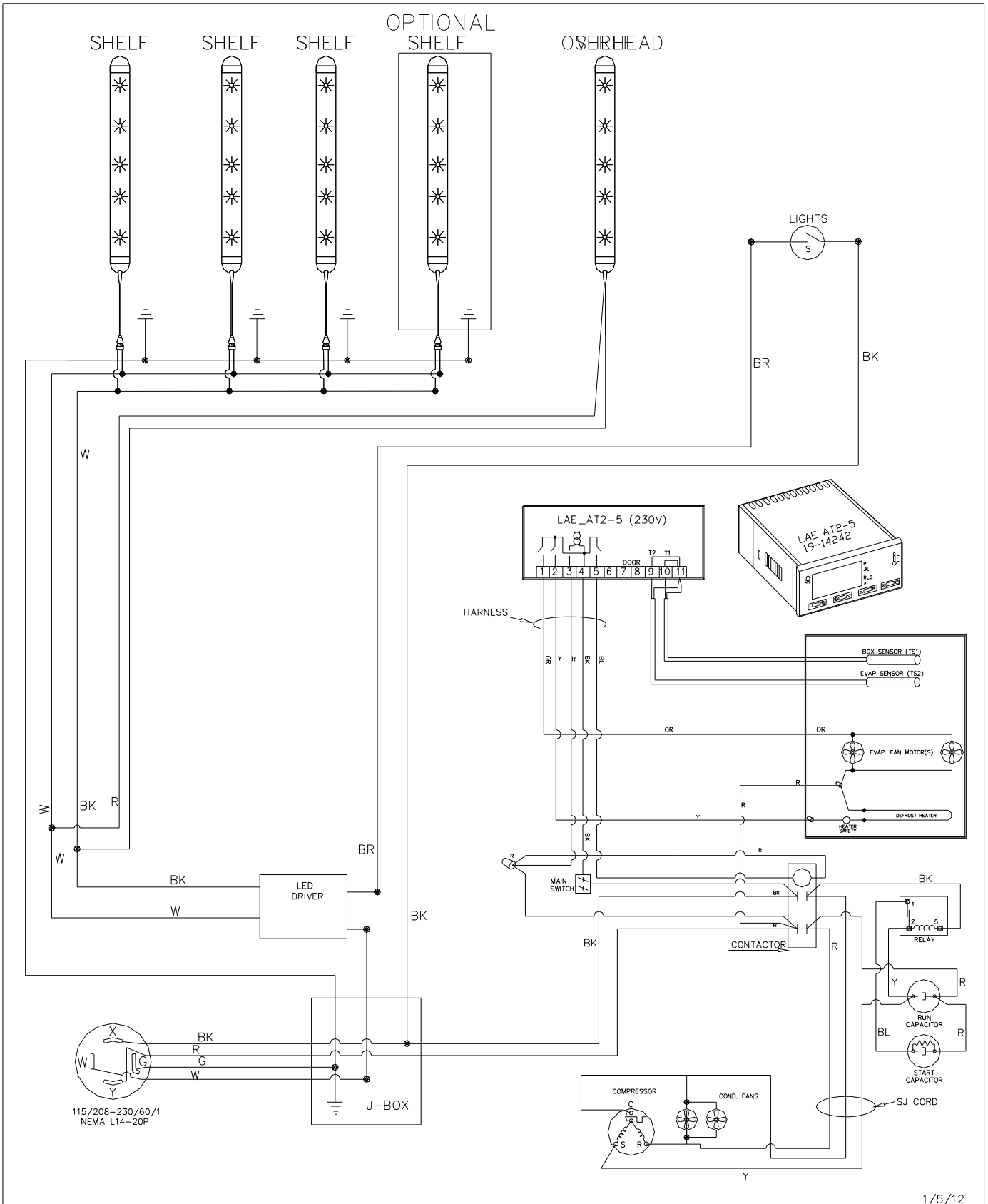

1/5/12

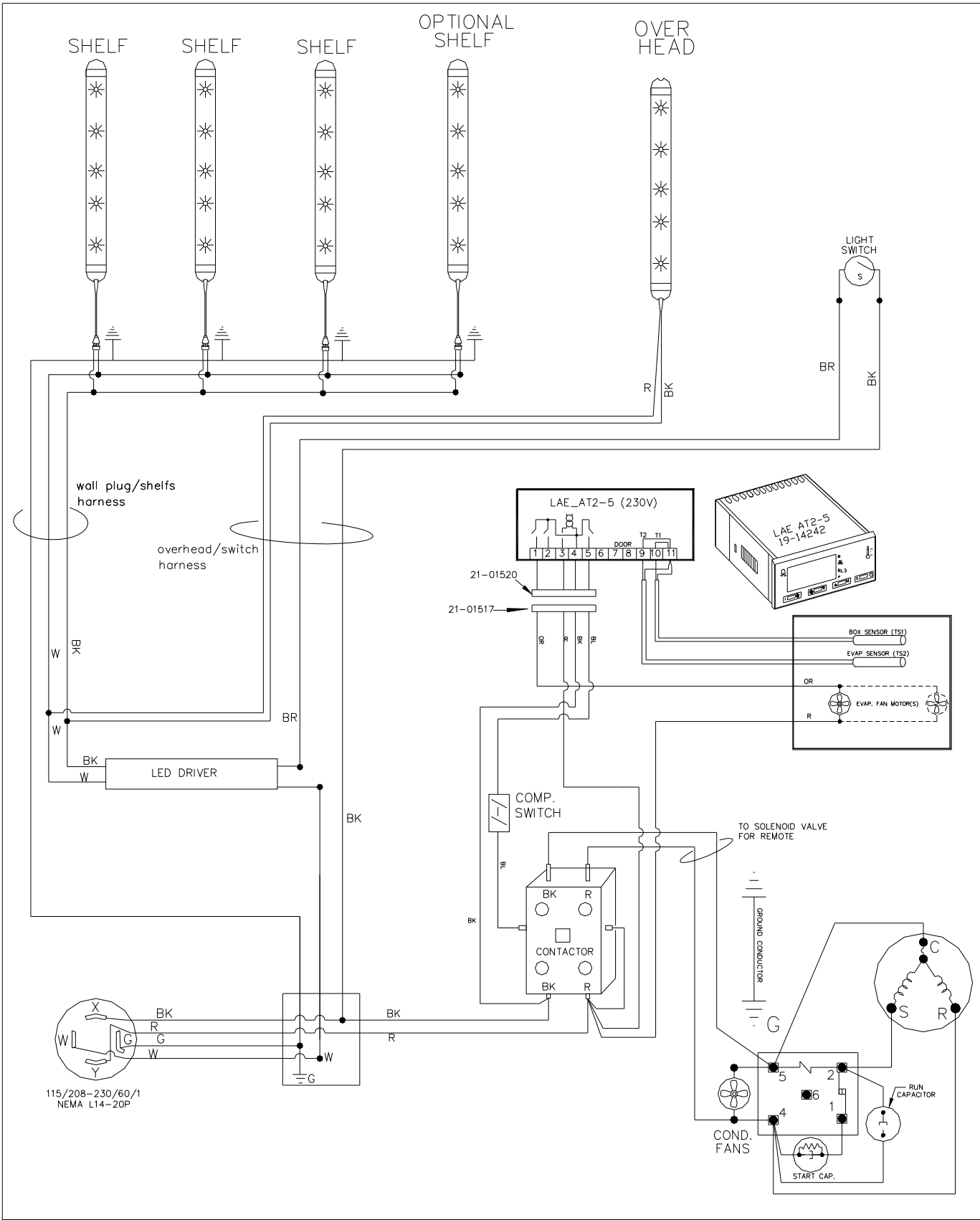

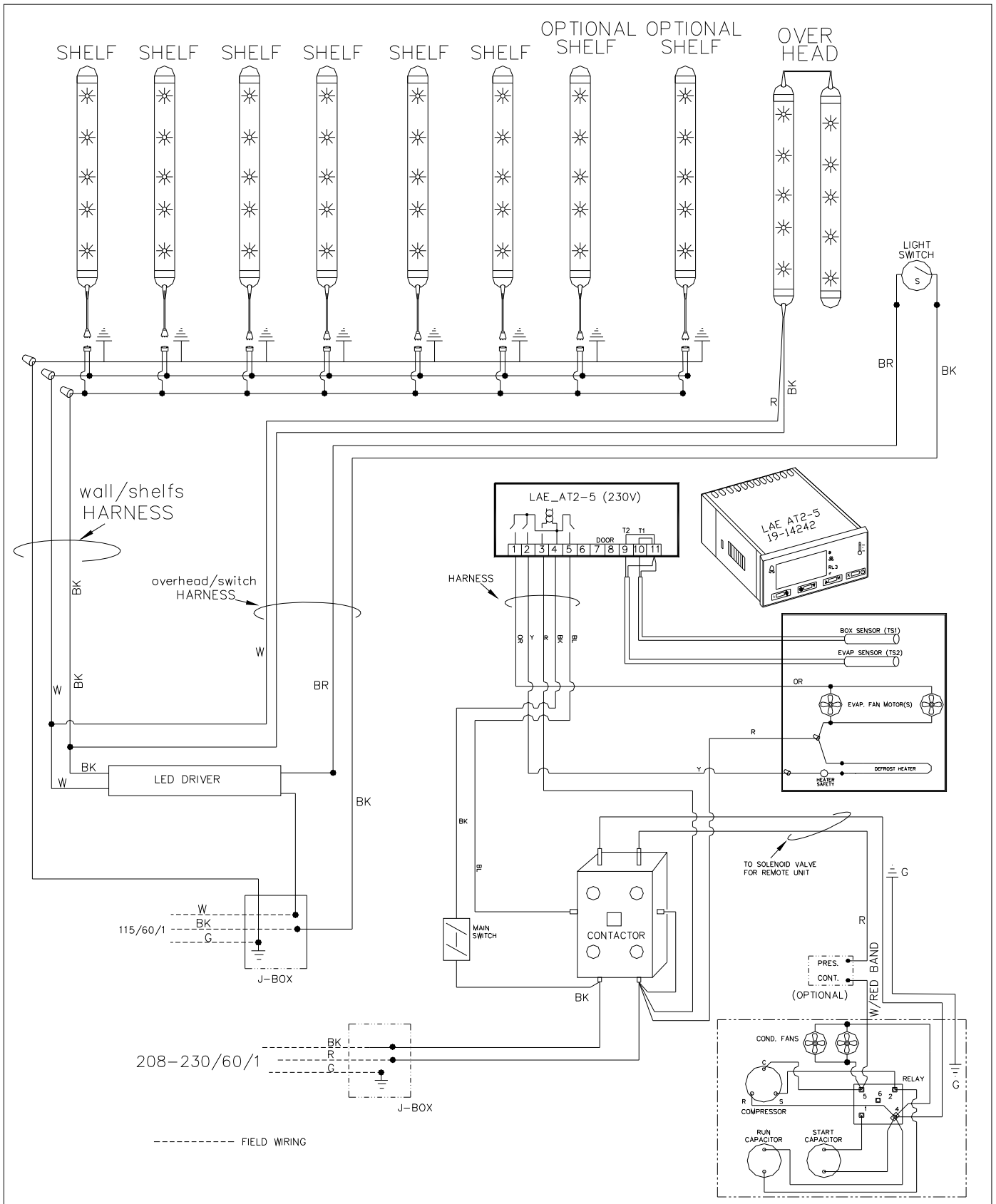

3-25-11