



MAXX ICE

SERVICE, INSTALLATION, AND INSTRUCTION MANUAL
MANUEL D'UTILISATION, D'INSTALLATION ET D'ENTRETIEN



MIM150N - MIM150NH

MIM200N - MIM200NH

MIM260N - MIM260NH

MIM320N - MIM320NH

AUTOMATIC COMMERCIAL ICE CUBE MACHINE

PLEASE READ CAREFULLY

MACHINE À GLAÇONS COMMERCIALE

VEUILLEZ LIRE ATTENTIVEMENT



MAXX ICE



CONTENTS

ICE MAKER SAFETY	2
IMPORTANT SAFEGUARDS	3 - 4
TECHNICAL INFORMATION	4
COMPONENT LOCATIONS	5
ICE MAKER INSTALLATION	6 - 10
Unpacking	6
Installing the Adjustable Feet	6
Installing the Stability Brackets	7
Location Requirements	7 - 8
Electrical Requirements	8
Leveling the Ice Maker	9
Water Supply	9
Installation Types	10
OPERATION	11 - 12
Final Checklist before Operation	11
Operating Method	11
How the Machine Makes Ice	12
Normal Sounds	12
Preparing the Ice Maker for Long Storage	12
CLEANING AND MAINTENANCE	13 - 14
Exterior Cleaning	13
Interior Cleaning	13
Water Distribution Tube Cleaning	14
Ice-Making System Cleaning	14
Sanitizing the Ice-Making System	14
Condenser Cleaning	14
CONTROL PANEL	15 - 17
TROUBLESHOOTING	17
TROUBLESHOOTING GUIDE	18
NOTES	19
FRENCH	19 - 36

We reserve the right to make changes in specifications and design without prior notice.

Be sure the ice machine has been standing upright.

ICE MAKER SAFETY

We have provided many important safety messages in this manual and on your appliance. Always read and obey all safety messages.



This is the Safety Alert Symbol. This symbol alerts you to potential hazards that can injure or kill you and others. All safety messages will follow the Safety Alert Symbol and either the words "DANGER", "WARNING" OR "CAUTION".

⚠ DANGER ⚠

DANGER means that failure to heed this safety statement may result in death or severe personal injury.

⚠ WARNING

WARNING means that failure to heed this safety statement may result in extensive product damage, serious personal injury, or death.

CAUTION

CAUTION means that failure to heed this safety statement may result in minor or moderate personal injury, or property or equipment damage.

All safety messages will alert you to what the potential hazard is, tell you how to reduce the chance of injury, and let you know what can happen if the instructions are not followed.

NOTE: IMPORTANT SAFETY INSTRUCTIONS

WARNING: To reduce the risk of fire, electric shock or injury, when using your ice maker, follow these basic precautions:

- Plug into grounded 3-prong outlet
- Do not remove grounding prong
- Do not use an adapter
- Do not use an extension cord
- Disconnect power before cleaning
- Disconnect power before servicing
- Replace all panels before operating
- Use 2 or more people to move and install ice maker

SAVE THESE INSTRUCTIONS



MAXX ICE



IMPORTANT SAFEGUARDS



Before the ice maker is used, it must be properly positioned and installed as described in this manual, so read the manual carefully. We strongly recommend that you have a professional install your new machine. The warranty may be affected or voided by an incorrect installation. To reduce the risk of fire, electrical shock or injury when using the ice maker, follow basic precautions, including the following:

⚠ DANGER ⚠

- Plug into a grounded 3-prong outlet. Do not remove grounding prong, do not use an adapter, and do not use an extension cord.
- It is recommended that a separate circuit, serving only your ice maker, be provided. Use receptacles that cannot be turned off by a switch or pull chain.
- Do not connect or disconnect the electric plug when your hands are wet.
- Never unplug the ice maker by pulling on the power cord. Always grip the plug firmly and pull straight out from the outlet.
- Never clean ice maker parts with flammable fluids. Do not store or use gasoline or other flammable vapors and liquids in the vicinity of this or any other appliance. The fumes can create a fire hazard or explosion.
- Before proceeding with cleaning and maintenance operations, make sure the power line of the unit is disconnected and the water line is shut off. (EXCEPTION: When cleaning the machine's ice making and water systems)
- Before operating, put all the enclosure panels back into their original places.
- Do not touch the evaporator with your hand when the machine is operating.
- Unplug the ice maker or disconnect power before cleaning or servicing. Failure to do so can result in electrical shock or death.
- Do not attempt to repair or replace any part of your ice maker unless it is specifically recommended in this manual. A qualified technician should do all other servicing.

⚠ WARNING

- Use two or more people to move and install ice maker. Failure to do so can result in back or other injury.
- To ensure proper ventilation for your ice maker, the front of the unit must be completely unobstructed. Choose a well-ventilated area with temperatures above 40°F (4.4°C) and below 110°F (43.3°C) This unit MUST be installed in an area protected from the elements, such as wind, rain, water spray or drips.
- The ice maker should not be located next to ovens, grills or other sources of high heat.
- The ice maker must be installed with all electrical and water connections in accordance with state and local codes. A standard electrical supply (115 VAC, 60 Hz, 15 A), properly grounded in accordance with the National Electrical Code and local codes and ordinances, is required.
- Do not kink or pinch power supply cord or drain lines between ice maker and cabinet.
- The fuse (or circuit breaker) size should be 15 amperes.
- It is important for the ice maker to be leveled in order to work properly. You may need to make several adjustments to level it.
- All installations must be in accordance with local plumbing code requirements.
- Make certain that the hoses are not pinched or kinked or damaged during installation.
- Check for leaks after connection.
- Remove the packing materials and clean the ice maker before using.
- Turn on the water supply tap before switching on the ice maker. Never turn the water supply tap off when the ice maker is working.

- Except to take ice from the unit, keep the door closed in order to reduce ice melting and to promote proper ice formation.
- Although the unit has been tested at the factory, due to long-term transit and storage, the first batch of cubes must be discarded.
- If the ice maker will not be used for a long time, before the next use it must be thoroughly cleaned. Follow carefully any instructions provided for cleaning or use of sanitizing solution. Do not leave any solution inside the ice maker after cleaning.
- DO NOT touch the condenser fins. The condenser fins are sharp and can be easily damaged.
- DO NOT use solvent-based cleaning agents or abrasives on the interior. These cleaners may transmit taste to the ice cubes, or damage or discolor the interior.
- The ice machine cleaner contains acids. DO NOT use or mix with any other solvent-based cleaner products. Use rubber gloves to protect hands. Carefully read the material safety instructions on the container of the ice machine cleaner.
- Do not use this apparatus for other than its intended purpose.

SAVE THESE INSTRUCTIONS

Electrical Connection

Do not, under any circumstances, cut or remove the third (ground) prong from the power cord. For personal safety, this appliance must be properly grounded. The power cord of this appliance is equipped with a 3-prong grounding plug that mates with a standard 3-prong grounding wall outlet to minimize the possibility of electric shock hazard from the appliance. Have the wall outlet and circuit checked by a qualified electrician to make sure the outlet is properly grounded. When a standard 2-prong wall outlet is encountered, it is your responsibility and obligation to have it replaced with a properly grounded 3-prong wall outlet.

The ice maker should always be plugged into its own individual electrical outlet which has a voltage rating that matches the rating label on the appliance. This provides the best performance and also prevents overloading house wiring circuits which could cause a fire hazard from overheated wires. Never unplug your ice maker by pulling on the power cord. Always grip the plug firmly and pull straight out from the outlet. Repair or replace immediately all power cords that have become frayed or otherwise damaged. Do not use a cord that shows cracks or abrasion damage along its length or at either end. When moving the ice maker, be careful not to damage the power cord.

Extension Cord

Because of potential safety hazards under certain conditions, it is strongly recommended that you do not use an extension cord with this ice maker.

Technical Information

MODEL	MIM150N/150NH	MIM200N/200NH	MIM260N/260NH	MIM320N/320NH
Electrical input	115VAC/60Hz	115VAC/60Hz	115VAC/60Hz	115VAC/60Hz
Power consumption (kW · h/100 lbs of ice)	7.0	8.17	7.15	6.89
Ice-making/Ice-harvest rated current	5.2A/6.4A	7A/7.4A	7.1A/9.8A	8A/9A
Refrigerant	R134a, 7oz	R404A, 8.11oz	R404A, 10.6oz	R404A, 12.5oz
High/Low side pressure	320psig/120psig	350psig/190psig	350psig/190psig	350psig/190psig
Unit width x depth x height	24" x 24" x 39"	24" x 24" x 39"	24" x 24" x 39"	30" x 28" x 39"
Unit weight	139 lbs	141 lbs	144 lbs	148 lbs
Ice storage capacity	88 lbs	88 lbs	88 lbs	128 lbs
Ice-making capability	121/124 lbs/day*	151/154 lbs/day*	222/220 lbs/day*	252/260 lbs/day*
Ice shape	Cube	Cube	Cube	Cube
Ice cube dimensions	Dice	7/8" x 7/8" x 7/8"	1/2" x 7/8" x 7/8"	7/8" x 7/8" x 7/8"
	Half dice	1/2" x 7/8" x 7/8"	1/2" x 7/8" x 7/8"	1/2" x 7/8" x 7/8"

*The actual quantity of ice produced per day can vary with room and water conditions. The technical data and performance index listed above should be used for reference only. They are subject to change.



MAXX ICE



Component Information

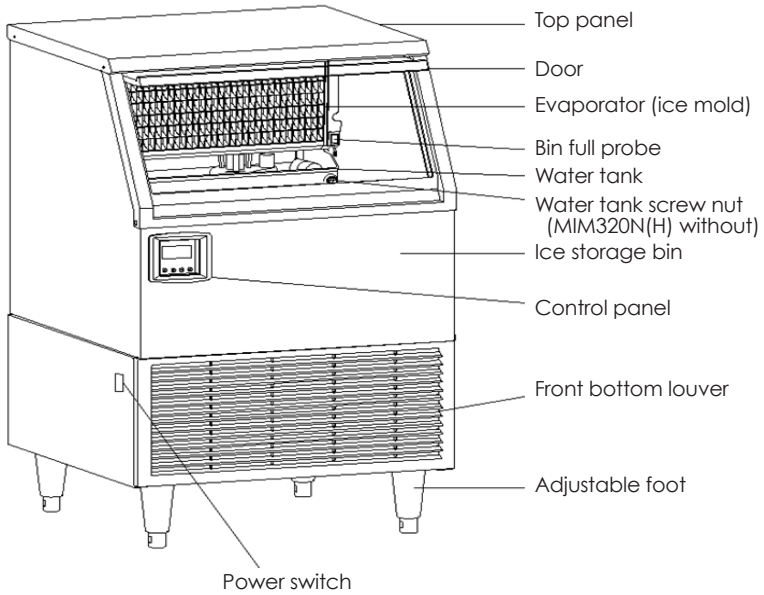

BACK VIEW

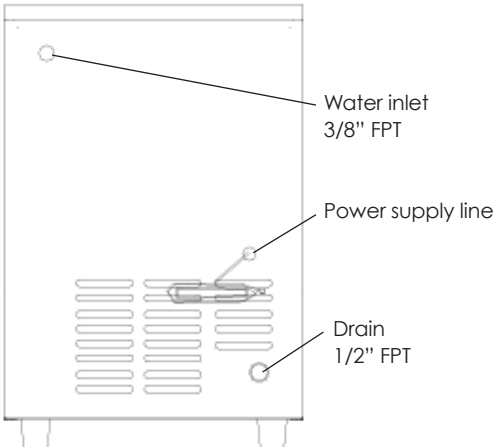

TOP VIEW

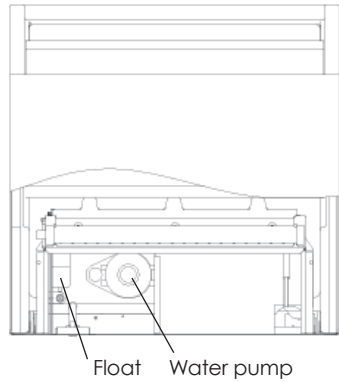

Stability brackets



Ice scoop

Ice Maker Installation

UNPACKING

⚠ WARNING

Excessive Weight Hazard

Use two or more persons to move and install ice maker.
Failure to do so can result in back or other injury.

REMOVE PACKAGING MATERIALS

IMPORTANT: Do not remove any permanent instruction labels or the data label on your ice maker.

Remove tape and glue from your ice maker before using.

- To remove any remaining tape or glue, rub the area briskly with your thumb. Tape or glue residue can also be easily removed by rubbing a small amount of liquid dish soap over the adhesive with your fingers. Wipe with warm water and dry.
- Do not use sharp instruments, rubbing alcohol, flammable fluids, or abrasive cleaners to remove tape or glue. These products can damage the surface of your ice maker.
- Leave lowermost foam panel in place until after the adjustable feet are attached.

Cleaning before use

After you remove all tape and glue from the machine, clean the inside of your ice maker before using it. See "Interior Cleaning" in the Cleaning and Maintenance section.

Installing the adjustable feet

At least two persons are required to install the adjustable feet.

You will find four adjustable feet packed in the ice storage bin. To install, tilt one side of the unit and screw in two adjustable feet, as illustrated. (*IMPORTANT: Do not tilt the unit more than 45°*). Then tilt the other side and screw in the remaining two feet.

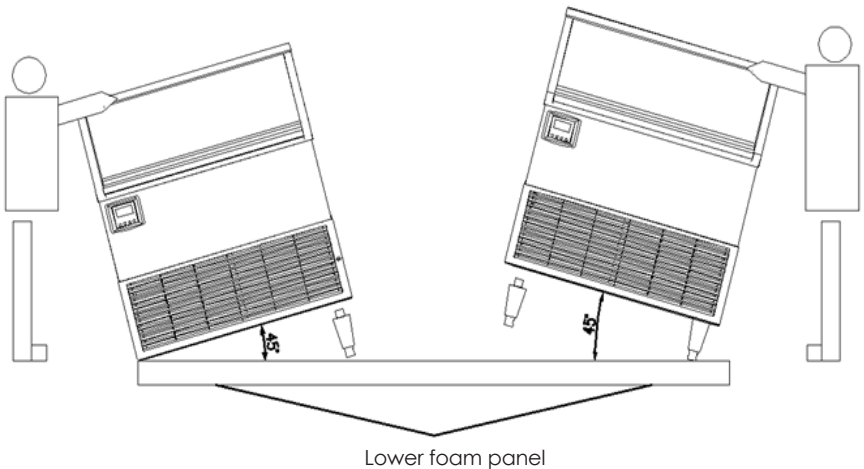



MAXX ICE



Ice Maker Installation

INSTALLING THE STABILITY BRACKETS

This operation requires at least two persons. If you wish to install the ice maker in a free-standing mode rather than enclosed, it is necessary to attach the two metallic stability brackets that can be found packed inside the ice storage bin. Keeping the machine tilted to the right, but not more than 45°, attach one bracket to the center of the underside of the ice maker with two screws (supplied). See illustration below. Set the unit back on its four feet, then tilt it forward in order to screw in the second bracket on the underside of the unit opposite the first bracket. Level the ice maker. This operation will stabilize it for free-standing operation.

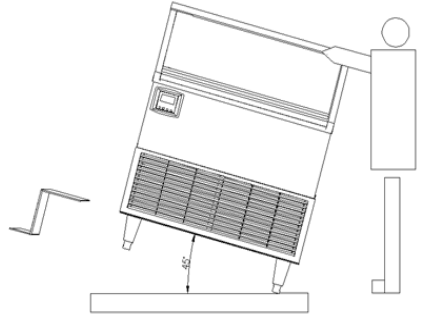

LOCATION REQUIREMENTS

This ice maker should be installed by qualified personnel.

NOTICE:

1. Before setting the ice maker inside a cabinet, connect the water supply pipe correctly. Untie the drain hose, insert it into the drain, and connect the power supply line.
2. Do not kink or pinch the power supply line between the ice maker and wall or cabinet.

Installation Clearance

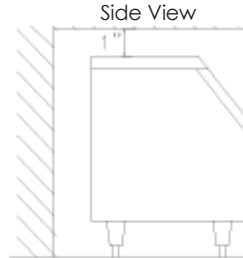
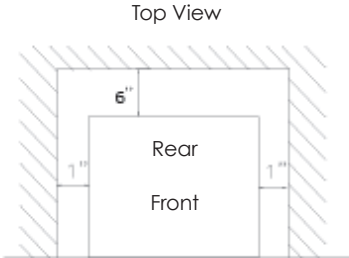

- To ensure proper ventilation for your ice maker, the front of the unit must be completely unobstructed.
- When installing the ice maker under a counter, follow the recommended spacing dimensions shown. Allow at least 6" (150 mm) clearance at rear, and 1" (25 mm) at the sides and at the top for proper air circulation. The installation should allow the ice maker to be pulled forward for servicing if necessary.
- Choose a well-ventilated area with temperatures above 40°F (4.4°C) and below 110°F (43.3°C). This unit **MUST** be installed in an area protected from the elements, such as wind, rain, water spray or drips.
- The unit should not be located next to ovens, grills or other sources of high heat.
- Installation of the ice maker requires a cold water supply inlet of 3/8" (9.5 mm) soft copper tubing with a shut-off valve.
- The ice maker requires a continuous water supply with a minimum pressure of 15 psig and a static pressure not to exceed 80 psig. The temperature of the water feeding into the ice maker should be between 40°F (4.4°C) and 90°F (32°C) for proper operation.

Ice Maker Installation

⚠ WARNING

Normal operating ambient temperature should be between 40°F (4.4°C) and 110°F (43.3°C). Normal operating water temperature should be between 40°F (4.4°C) and 90°F (32°C). Operation of the ice maker for extended periods outside of these normal temperature ranges may affect production capacity.

- **IT IS STRONGLY RECOMMENDED TO USE A WATER FILTER. A FILTER, IF IT IS OF THE PROPER TYPE, CAN REMOVE TASTE AND ODORS AS WELL AS PARTICLES AND CAN PROLONG THE LIFE OF THE MACHINE.**
- The ice maker must be installed with all electrical and water connections in accordance with state and local codes.
- The unit should be located on a firm and level surface. It is important for the ice maker to be level in order to work properly. If needed, you can adjust the height of the ice maker by rotating the feet. See the Leveling the Ice Maker section.

ELECTRICAL REQUIREMENTS

⚠ DANGER ⚠



Plug into a grounded 3-prong outlet.
Never remove the grounding prong from the plug.
Never use an adapter.
Never use an extension cord.
Failure to follow these instructions can result in fire, electrical shock or death.

Before you move your ice maker into its final location, it is important to make sure you have the proper electrical connection. A standard electrical supply (115 VAC, 60 Hz, 15 A), properly grounded in accordance with the National Electrical Code and local codes and ordinances, is required. The ice maker should always be plugged into its own individual electrical outlet. It is recommended that a separate circuit, serving only your ice maker, be provided. Use receptacles that cannot be turned off by a switch or pull chain. The fuse (or circuit breaker) size should be 15 amperes.

Recommended grounding method

For your personal safety, this appliance must be grounded. It is equipped with a power supply cord having a 3-prong grounding plug. To minimize possible shock hazard, the cord must be plugged into a mating 3-pronged and grounding-type wall receptacle, grounded in accordance with the National Electrical Code and local codes and ordinances. If a mating wall receptacle is not available, it is the personal responsibility of the customer to have a properly grounded, 3-prong wall receptacle installed by a qualified electrician.



MAXX ICE



Ice Maker Installation

LEVELING THE ICE MAKER

Once the ice cube machine is set in its enclosure, if the base is not level, you can adjust the feet by rotating the under block (see below) until the machine is level.

It is important for the ice maker to be leveled, or water may not flow properly through the evaporator (ice mold). Ice production will be lower than normal, and operation will be noisy.

Adjust the height of the under block of the adjustable foot, rotating it to the right (counter-clockwise) to lower that side of the ice maker. Turning the under block to the left (clockwise) raises that side of the ice maker.

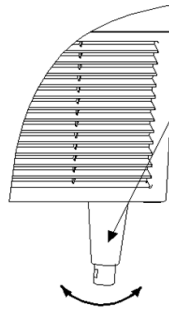

Under block

Turning the under block counter-clockwise reduces the machine's height up.

Turning the under block clockwise increases the machine's height

Water Supply

The water supply should be ready at the point of installation. The water supply pressure should be a minimum of 15 psig with a static pressure not more than 80 psig. (A wall outlet directly behind the ice maker will make installation easier.)

We strongly recommended the use of a water filter. A filter, if it is of the proper type, can remove taste and odors as well as particles and can prolong the life of the machine.

IMPORTANT:

1. All installations must be in accordance with local plumbing code requirements. Professional installation is recommended.
2. Water inlet fitting: 3/8" FPT (Female Pipe Thread); drain line connection: 1/2" FPT.
3. Make certain you have a suitable water supply hose and two suitable drain hoses, and that the hoses are not pinched, kinked or damaged during installation.
4. Check for leaks after connection.

Tools required: 3/8" open-end wrench, Phillips screwdriver

Connecting the water line:

1. Turn off main water supply.
2. Find a water supply line near the installation location. The distance should be less than the length of the water supply hose.
3. A shut-off valve must be installed to the main water supply.
4. Connect the water supply hose to tap and water inlet valve. Tighten firmly by hand, then one-half turn with wrench.
5. Connect one water drain hose to ice maker drain line connection. Tighten firmly by hand, then one-half turn with wrench.
6. Connect another water drain hose to bin drain line connection. Tighten firmly by hand, then one-half turn with wrench.
7. Turn on main water supply and tap. Check for water supply connection leaks. Tighten every connection (including connections at the water inlet).

NOTE: If using a water filter, be sure to follow the filter manufacturer's directions.

Ice Maker Installation

INSTALLATION TYPES

This ice cube machine has been designed to be enclosed (as under a cabinet). It can also be free-standing (using the supplied stability brackets) or built-in (sealed to the floor). In every case, there must be adequate air space around the unit for ventilation purposes.

Enclosed Installation:

An enclosed installation will allow you to install the ice cube machine under a counter or in a kitchen cabinet provided the required clearance space around the ice maker is respected. You must follow the stated instructions for

- a. Electrical requirements
- b. Water supply

Free-standing Installation:

The ice cube machine can be installed to be free-standing in any place you desire provided you have access to a water supply. This installation has the same requirements as an enclosed installation, plus you must also follow the stated instructions for Installing the Stability Brackets.

Built-in Installation:

If this method of installation is chosen, it will still be necessary to allow adequate ventilation space around the unit. The following additional items must be observed.

1. Place the ice cube machine in front of the installation location. Raise the machine and place it on the floor or on a platform depending on your installation requirements.
2. The water supply line must be plumbed before connecting to the ice maker.
3. Turn on the main water supply and tap. Check for water supply connection leaks. Tighten every connection (including connections at the water inlet).
4. If the electrical outlet for the ice maker is behind the cabinet, plug in the ice maker.
5. Push the ice maker into position.
6. Seal all around the cabinet to the floor with an approved caulking compound.



MAXX ICE



Operation

FINAL CHECK LIST BEFORE OPERATION

1. Have all packing materials and tape been removed from the interior and exterior of the ice maker?
2. Did you clean the ice storage bin?
3. Have the installation instructions been followed, including connecting the machine to water and electricity?
4. Has the machine been leveled?
5. Is the ice cube machine in a site where the ambient temperature is between 40° F (4.4° C) and 110° F (43.3° C) and the water temperature between 40° F (4.4° C) and 90° F (32° C) all year round?
6. Has the water supply pressure been checked to ensure a minimum of 15 psig with a static pressure not to exceed 80 psig?
7. Is there a clearance of at least 6" (150 mm) at the rear, 1" (25 mm) at the top and sides for proper air circulation?
8. Has the power supply voltage been checked or tested against the nameplate rating? And has proper grounding been installed for the ice cube machine?
9. Is the ice cube machine plugged in?
10. Have you turned on the main water supply and the tap?
11. Have you checked for leaks at all water supply connections?

OPERATING METHOD

1. Turn on the water tap, letting the water enter the water tank, then turn the power switch ON. And press ON/OFF button in front panel. The LCD screen lights.
2. After about 3 minutes, the ice maker will automatically proceed to the ice-making stage, and the sound of flowing water will be heard. The words of "Making ice" displays on the LCD screen.
3. When the batch of ice has been fully formed, ice will automatically fall into the ice storage bin. The words of "Harvesting Ice" displays on the screen.
4. When the ice storage bin is full, the sheet of cubes will not fall completely and will hold the bin full probe open. The machine is in the bin full mode, and the words of "Bin Full" displays on the LCD screen. The unit stops working.
5. The unit starts making ice again automatically approximately 3 minutes after ice cubes are removed. As ice is removed, the bin full probe swings back to operating position.

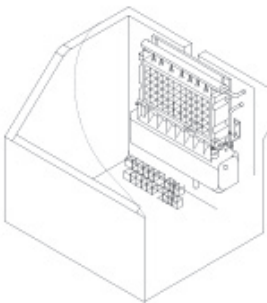

Ice-making stage

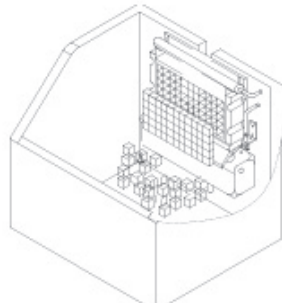

Ice harvest stage

IMPORTANT:

- Although the unit has been tested and cleaned at the factory, due to long-term transit and storage, the first batch of cubes must be discarded.
- Never turn the water supply tap off when the ice maker is working.
- Never touch the evaporator when the machine is running.
- Except to take ice from the unit, keep the door closed to reduce melting and insure proper ice formation.

Operation

HOW THE MACHINE MAKES ICE

Turn the power switch to the ON position. Then press ON/OFF button in front panel, The LCD screen lights. After about 3 minutes the machine will automatically go into the ice-making stage.

There are two distinct cycles: Freeze and Harvest. During the Freeze cycle, water flows to the evaporator surface. In the Harvest cycle, the ice is released and water enters the machine. A complete cycle can take 15 to 40 minutes, depending on ambient temperature and operating conditions.

Freeze: During the Freeze cycle the compressor is pumping refrigerant, the fan motor is blowing air, and the water pump is circulating water. When the batch of ice has been fully formed, the ice maker stops the Freeze cycle and begins the Harvest cycle.

Harvest: During the Harvest cycle the compressor is still operating, power is supplied to the water purge valve and hot gas valve. The water purge valve opens and allows the water pump to purge the water remaining in the water tank, removing all impurities and sediment. This allows the machine to make clear ice cubes and keep mineral build-up at a minimum. Then the water pump stopped. The hot gas valve opens, diverting hot refrigerant gas into the evaporator. The gas warms the evaporator, causing the cubes to slide as a unit off the evaporator and into the storage bin. The Freeze cycle will restart when all the cubes drop into the bin.

HOW THE MACHINE USES WATER:

The ice cube machine begins with a fixed charge of water that is contained in the water tank. As the water flows to the freezing evaporator surface, the water will freeze and stick to the ice cube molds. During the ice-making process, fresh water enters the water tank continuously as the water from the trough freezes continuously on the evaporator.

NORMAL SOUNDS

Your new ice cube machine may make sounds that are unfamiliar to you. Most of the new sounds are normal. Hard surfaces like the floor and walls can amplify the sounds. The following describes the kinds of sounds that might be new to you and what may be causing them.

- Rattling noises may come from the flow of the refrigerant or the water line. Items stored on top of the ice cube machine can also make noises.
- The high-efficiency compressor may make a pulsating or high-pitched sound.
- Running water may make a splashing sound.
- You may hear air being forced over the condenser by the condenser fan.
- During the Harvest cycle, you may hear the sound of ice cubes falling into the ice storage bin.

PREPARING THE ICE CUBE MACHINE FOR LONG STORAGE

If the ice cube machine will not be used for a long time, or it is to be moved to another place, it will be necessary to drain the system of water.

1. Shut off the water supply at the main water source.
2. Disconnect the water supply line from the water inlet.
3. Shut off the power supply at the main electrical power source.
4. MIM150N(H)/200N(H)/260N(H): Screw off the water tank screw nut and drain out water completely, tighten the nut after finishing. Dry the tank. Note: Don't forget to screw the nut back into place again.
MIM320N(H): Depress the clean button and hold for six seconds. Draining mode starts automatically. When the words "Water Fill" display, the drain process is complete. Dry the tank.
5. Remove the ice from the ice storage bin. Dry the bin.
6. Leave the door open to allow for circulation and to prevent mold and mildew.
7. Leave the water supply line and power cord disconnected until ready to reuse..

IMPORTANT:

- Do not touch the power plug when your hands are wet.
- Never unplug the unit by pulling on the cord.

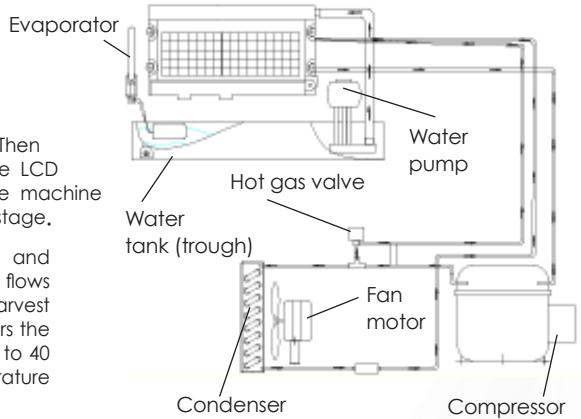



MAXX ICE



Cleaning and Maintenance

CAUTION

If the ice maker is left unused for a long time, before the next use it must be thoroughly cleaned. Follow carefully any instructions provided for cleaning or use of sanitizing solution. Do not leave any solution inside the ice maker after cleaning.

Periodic cleaning and proper maintenance will ensure efficiency, top performance, and long life. The maintenance intervals listed are based on normal conditions. You may want to shorten the intervals if you have pets or there are other special considerations.

WHAT SHOULDN'T BE DONE

Never keep anything in the ice storage bin other than ice: objects like wine and beer bottles are not only unsanitary, but the labels may slip off and plug up the drain.

WHAT SHOULD BE KEPT CLEAN

There are 4 things to keep clean:

1. The exterior
2. The interior
3. Water distribution tube
4. The ice-making system cleaning

⚠ WARNING

Before proceeding with cleaning and maintenance operations, make sure the power line of the unit is disconnected and the water line is shut off. (EXCEPTION: Cleaning of ice-making system)

EXTERIOR CLEANING

The door and cabinet may be cleaned with a mild detergent and warm water solution such as 1 oz of dishwashing liquid mixed with 2 gallons of warm water. Do not use solvent-based or abrasive cleaners. Use a soft sponge and rinse with clean water. Wipe with a soft clean towel to prevent water spotting. Clean stainless steel with a cloth dampened with a mild detergent and warm water solution. Never use an abrasive cleaning agent.

INTERIOR CLEANING

The ice storage bin should be sanitized occasionally. Clean the water tank before the ice cube machine is used for the first time and reused after stopping for an extended period of time. It is usually convenient to sanitize the trough after the ice-making system has been cleaned and the ice storage bin is empty.

1. Disconnect power to the unit.
2. Open the door.
3. Using a sanitizing solution made of 1 ounce of household bleach and 2 gallons of hot water (95° to 115°F), wipe down the water tank and the inside of the ice storage bin with a clean cloth. To clean hard-to-reach corners, apply the sanitizing solution with a spray bottle.
4. Rinse thoroughly with clear water. This completes the routine interior cleaning of the unit.
5. Reconnect the power.
6. The ice scoop should be washed regularly. Wash it just like any other food container.

⚠ WARNING

DO NOT use solvent-based cleaning agents or abrasives on the interior. These cleaners may transmit taste to the ice cubes, or damage or discolor the interior.

Cleaning and Maintenance

WATER DISTRIBUTION TUBE CLEANING

When you find that the ice cubes are incompletely formed or the output of ice cubes is low, the water distribution tube may be blocked. Set the power switch to OFF. Unscrew the six screws holding the top panel and remove the panel. You will see the water distribution tube. Rotate the water distribution tube so that the holes in it are facing up. Using a toothpick or similar tool, dredge the holes, then rotate the water distribution tube back to its original position. If the tube is badly blocked, clean it as follows:

1. Shut off the water and power supplies.
2. Disconnect the water hose from the distribution tube.
3. Lift one side, remove the distribution tube.
4. With a brush, clean the tube with a dilute solution of warm water and a mild detergent such as dishwashing liquid. After removing the dirt and lint from the surface, rinse the tube with clean water.
5. Replace the distribution tube.
6. Reconnect the water supply and power supply lines.
7. Re-attach the top panel.

ICE-MAKING SYSTEM CLEANING

Minerals that are removed from water during the freezing cycle will eventually form a hard, scaly deposit in the water system. Cleaning the system regularly helps remove the mineral scale buildup. How often you need to clean the system depends on how hard your water is or how effective your filtration may be. With hard water of 15 to 20 grains/ gallon (4 to 5 grains/liter), you may need to clean the system as often as every 3 months.

1. Set the power switch to OFF.
2. Remove all ice cubes from the storage bin. If ice is being made, initiate harvest or wait for cycle completion then turn machine off at the power switch.
3. Keep the ice maker connected to the water supply. Pour 8 oz. of Nickel-Safe Ice Maker Cleaner Solution into the water tank.
4. Turn the power switch ON and press ON/OFF button to light the LCD screen. Within 3 minutes, press the CLEAN button. The machine will automatically shift into cleaning mode.
5. The cleaning cycle will continue for 30 minutes unless you press ON/OFF button (you can press the power switch to stop the cleaning cycle any time during the 30 minutes). After cleaning, the LCD screen will display the words of "OFF". The cleaning process stops.
6. The dirty water must be drained out completely. Perform steps 2 and 3 in the Interior Cleaning section.
7. Repeat steps 3 to 6 above three times to rinse the ice-making system completely. NOTE: Do not add Ice Maker Cleaner Solution to the water trough during the rinses.
8. If you want to make ice cubes after cleaning, turn off the power switch, drain off the waste water, then turn on the power switch. The next ice-making cycle will begin.
9. Discard the first batch of ice.

⚠ WARNING

The ice machine cleaner contains acids. DO NOT use or mix with any other solvent-based cleaner product. Use rubber gloves to protect hands.

Carefully read the material safety instructions on the container of the ice machine cleaner. DISCARD the first batch of ice produced after cleaning.

CONDENSER CLEANING

The air-cooled condenser should be vacuumed once or twice per year to remove any lint that may have been drawn into it.

1. Unplug the ice maker or disconnect power.
2. Gently pull off the bottom louver.
3. Remove dirt and lint from the condenser and the air filter with brush attachment of a vacuum cleaner. Use a pointed tool like a toothpick to remove any lint that adheres to the condenser fins.
4. Reassemble the air filter and the bottom louver.
5. Plug in the ice maker or reconnect power.

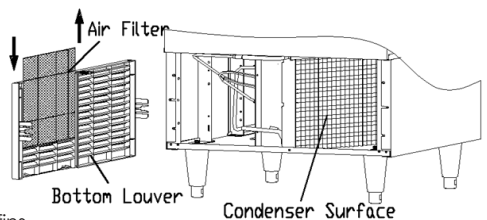



MAXX ICE



Control Panel (located at the left side of front panel)

You will find the control panel at the left side of front panel. This control panel offers four pressure sensitive buttons and a LCD display screen.

- 1 ON/ OFF Button.** Powers the ice machine.
- 2 Bin Full Process:** When the words of "Bin Full" display, the ice storage bin is full of ice or something is holding the water curtain open. The unit will stop working when ice cubes are taken out of the ice storage bin, releasing the water curtain, the words of "Bin Full" will flash for 3 minutes. The unit will then restart and returns to the ice making mode.
- 3 Making Ice Process:** When the words of "Making Ice" display, the unit is working in the Ice Making mode controlled by a temperature probe on the evaporator and a fixed timer.
- 4 Harvesting Ice Process:** When the words of "Harvesting Ice" display, the unit is working in the Ice Harvest mode controlled by a temperature probe on the evaporator and a fixed timer.
- 5 Clean Button:** When this button is pressed, the unit enters the Cleaning mode. the screen will display "Cleaning" To stop the Cleaning mode, just press the ON/OFF button.
- 6 Mode Button:** *Recommended for service technician only.* When this button is pressed, unit can change from Ice Making mode to Ice Harvest mode or from Ice Harvest mode to Ice Making mode. You can judge the mode from the displaying contents on the screen.
- 7 Water Fill Process:** When the words of "Water Fill" display, there are three minutes for water inlet and self-checking After three minutes the ice maker will start to make ice automatically.

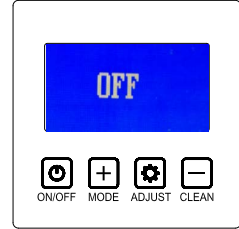

OPERATION OF THE CONTROL PANEL:

- When the unit is plugged in and turn on the power switch. Only "OFF" displays on the LCD screen.
- Press the ON/OFF button, the LCD screen lights. If normal, only the words of "Water Fill" and "3 Min To End" displays on the LCD screen. The ice maker will start to make ice automatically when the words of "3 Min To End" changes to "0 Min To End".



Note:

- When the ice machine runs in "Water Fill" process, the control board will check the condenser probe, evaporator probe and bin full probe function, if one of them defaults, the exclamation mark will appear and blink on the left bottom corner of the LCD screen. At this time press "ADJUST" button, the Diagnostics for bin full probe, condenser probe and evaporator probe will appear on the LCD screen. See photos below.

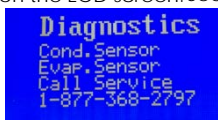

or

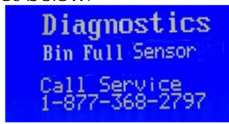

- After three minutes, the ice maker will start to make ice automatically. The words of "Making Ice" displays on the LCD screen.
- When the ice machine runs in harvest process, the words of "Harvesting Ice" displays on the LCD screen.
- When the ice storage bin is full of ice cubes or there is something obstructing the bin full probe, the words of "Bin Full" displays on the LCD screen. The unit stops working.

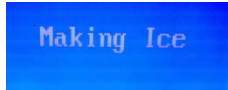

6. When ice cubes are removed from from the ice storage bin, clearing the bin full probe, the machine will judge the status for three minutes. During this period, the LCD screen will display the words of "Bin Full Release" and "3 Min To End". "Bin Full Release" flashes until the words "3 Min To End" changes to "0 Min To End". At this time, the ice maker will start to make ice automatically.



7. **TO CLEAN THE MACHINE**, press the ON/OFF button first, then press it on again.

- During "Water Fill" process, press the "CLEAN" button, the ice maker will start the cleaning process, the words of "Cleaning", "Add chemical" and "30 Min To End" display on the LCD screen.
- At the first one minute, the words of "Add chemical" flash to remind pouring the Ice Maker Cleaner Solution into the water tank until the words of "30 Min To End" changed into "29 Min To End", the words of "Add chemical" disappear and the water pump runs, the ice maker goes into cleaning process.
- The ice-making system cleaning cycle will continue until the words of "30 Min To End" changed into "0 Min To End", the cleaning process stops and the ice machine is in suspend mode.
- You can press the ON/OFF button to stop the cleaning cycle any time during the cleaning mode.
- If you want to make ice cubes after cleaning, press the ON/OFF twice, the next ice-making cycle will begin.

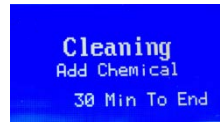

NOTE:

Pressing the CLEAN BUTTON has no effect when the ice maker runs in ice-making, harvest and bin full process.

Additional Functions:

1. **Draining Function:** press the "Clean" button and hold for 6 seconds, the machine will go into the draining water mode automatically. The words of "Purging Water" appear on the LCD screen. The words disappear after 3 minutes and the draining process stops. **NOTE:** Draining function only effect in "Water Fill" process and "Cleaning" process.
2. **Self-checking Function:** when the ice maker runs, the control board will check the condenser probe, evaporator probe, high condenser temperature, water shortage, long freeze, long harvest and bin full probe function, if one of them defaults, the exclamation mark will appear and blink on the left bottom corner of the LCD screen. At this time press "ADJUST" button, the cause of default will appear on the LCD screen.
3. **Purging cycle interval Optional Function:** during "Water Fill" process, press and hold the "CLEAN" button and "ADJUST" button together for at least 3 seconds. The unit will enter the "Purging Optional" process, the words of "Purging Optional" and "20 Cycle" (Note: The cycle number may display other number) appear on the LCD screen. During this period, you can press the "MODE" or "CLEAN" button for the desired purging cycle interval. You can choose any purging cycle interval from 0 to 20.
4. After 10 seconds without any operation, the unit will automatically memorize the current status and return to the previous process.



NOTE: The machine is only in "Water Fill" process, the purging cycle interval optional function can be accessed.

IMPORTANT: The purging cycle interval 20 has been set at the factory for optimum performance. You can change it according to the quality of water.



MAXX ICE



ICE BRIDGE SIZE ADJUSTMENT GUIDE:

1. Press and hold the "ADJUST" button for at least 3 seconds. The unit will enter the Ice Size Adjustment mode and the words "Ice Adjust" display on the LCD Screen.
2. While in the Ice Size Adjustment mode, press the "Clean" button or the "Mode" button for the desired ice size.

SMALLER ICE SETTING:

By pressing the "Clean" button, you can decrease the size of the ice bridge. The words of "-6 Minutes" indicate the smallest ice size.

LARGER ICE SETTING:

By pressing the "Mode" button, you can increase the size of the ice bridge. The words of "+10 Minutes" indicate the largest ice size. *After 10 seconds without any operation, the unit will automatically memorize the current state and return to the previous mode.*

NOTE:

- If during the ice size adjustment mode the words of "Ice Adjust" and "0 Minute" display on the LCD screen, this indicates that the unit is in the regular (middle) setting of the ice size.
- When the machine is in the cleaning stage or ice full stage, the ice size adjustment mode cannot be accessed.

IMPORTANT:

- The ice bridge adjustment has been set at the factory for optimum performance and it is not recommended for a user to make this adjustment. This ice adjustment procedure should be made only by an authorized service technician.

IMPORTANT:

- Although the unit has been tested and cleaned at the factory, due to long-term transit and storage, the first batch of cubes must be discarded.
- Never turn the water supply tap off when the ice maker is working.
- Never touch the evaporator when the machine is running.
- Keep the door closed as much as possible to reduce melting and insure proper ice formation.

IMPORTANT:

- Avoid letting water contact the control box.

Troubleshooting

BEFORE CALLING FOR SERVICE

If the unit appears to be malfunctioning, read through the OPERATION section of this manual first. If the problem persists, check the Troubleshooting Guide on the following page. The problem may be something very simple that can be solved without a service call.

Troubleshooting Guide

PROBLEM	POSSIBLE CAUSE	PROBABLE CORRECTION
The machine doesn't operate	The ice maker is unplugged.	Plug the ice maker in.
	The fuse is blown.	Replace fuse--if it happen, call for service to check for a short circuit in the ice maker.
	The ice maker power switch is OFF.	Turn the ice maker power switch to ON
	The ice storage bin is full of ice.	Take away some ice, make the ice-full sensor is free of ice.
The water doesn't feed in after the ice maker starts.	The water supply tap is turn off.	Turn on the water supply tap.
	The water supply pipe is not proper connected.	Reconnect the water supply pipe.
Machine makes ice, but bin does not fill up with ice	The condenser may be dirty.	Clean the condenser.
	The air flow to the ice maker may be obstructed.	Check the installation.
	The ambient temperature and water temperature are high, or it is near with some heat resource.	Check the installation.
Water is leaking out the unit.	A few water drops to the floor when you open the door to take out ice from ice storage bin.	Normal condensation on the door or some water together with ice. Take care when you take out ice.
	Water supply connection leaks.	Tighten fitting. See Connecting the water line.
Cubes are partially formed--are white at the bottom.	Not enough water in the water bin.	Check if the water supply pressure is below 15psig.
		Check water supply--filter may be restricted.
		Check for a water leak at the water tank.
Noise during operation	The feet are not leveled.	See Leveling the Ice Maker.
	Certain sounds are normal.	See Normal Sounds.
The icemaker stops suddenly while making ice.	The electricity is off.	Reconnected the power supply line.
	The room temperature is out the state range.	Cut off the electricity, let the ice maker stop working fill the temperature returns within the stated range.
The body of the ice maker is electrified	The earth line isn't in the socket.	Please use the socket meeting the standard.
Scales occur frequently inside the machine.	The hardness of the water quality is too high.	Using a water-soften apparatus installed in front of the water inlet.
The ice cubes are not completely formed when being dumped.	The sprinkler is blocked.	Clean the sprinkler, see "interior cleaning"

