

# BroilVection™

## Model JF63-BG/JF63-2-BG

### Natural Gas/LP

### Owner's Manual



#### APPROVALS:



#### FOR YOUR SAFETY:

Do not store or use gasoline or other flammable vapors or liquids in the vicinity of this or any other appliance.

#### WARNING:

Improper installation, adjustment, alteration, maintenance can cause property damage, injury, or death. Read the installation, operating and maintenance instructions thoroughly before installing or servicing this equipment.

Broiler area must be kept free of combustible materials, and the flow of combustion and ventilation air must not be obstructed. Operating personnel must not perform any maintenance or repair functions. Contact your Nieco Authorized Dealer.

**IMPORTANT: RETAIN THIS MANUAL IN A SAFE PLACE FOR FUTURE REFERENCE**

# TABLE OF CONTENTS

|   |           |
|---|-----------|
| <b>A. General Information</b>               | <b>3</b>  |
| A.1 Description                             | 3         |
| A.2 Warranty Information                    | 3         |
| A.3 Service/Technical Assistance            | 4         |
| A.4 Safety Information                      | 4         |
| <b>B. Machine Installation</b>              | <b>6</b>  |
| B.1 Pre-Installation                        | 6         |
| B.2 Mounting                                | 6         |
| B.3 Leveling                                | 6         |
| B.4 Hood Requirements                       | 6         |
| B.5 Clearance                               | 6         |
| B.6 Gas Connection                          | 7         |
| B.7 Flexible Gas Line Installation          | 7         |
| B.8 Restraining Device                      | 8         |
| B.9 Electrical Connection                   | 8         |
| B.10 Pre-Operation Check                    | 8         |
| <b>C. Operation</b>                         | <b>9</b>  |
| C.1 Controls and Indicators                 | 9         |
| C.2 Step-by-Step Lighting Procedure         | 11        |
| C.3 Shutdown Procedure                      | 12        |
| C.4 Control Operation                       | 13        |
| <b>D. Assembly/Disassembly and Cleaning</b> | <b>15</b> |
| <b>E. Troubleshooting</b>                   | <b>30</b> |
| <b>F. Wiring Diagrams</b>                   | <b>31</b> |
| <b>G. Specifications</b>                    | <b>33</b> |

# A. GENERAL INFORMATION

## A.1 Description

The Nieco® Model JF63-BG automatic broiler features patented BroilVection™ technology, easy cleaning and a simple and intuitive control package to help eliminate broiling problems and provide the operator with even greater control over the broiling environment.

This manual provides the safety, installation and operating procedures for the Nieco Automatic Broiler Model JF63-BG. We recommend that all information contained in this manual be read prior to installing and operating the broiler.

## A.2 Warranty Information

Please read the full text of the limited Warranty in this manual.

If the unit arrives damaged, contact the carrier immediately and file a damage claim with them. Save all packing materials when filing a claim. Freight damage claims are the responsibility of the purchaser and **ARE NOT** covered under warranty.

The warranty **does not** extend to:

- Damages caused in shipment or damage as a result of improper use.
- Installation of electrical service.
- Normal maintenance as outlined in this manual.
- Malfunction resulting from improper maintenance not in accordance with the steps contained in this manual and any applicable training.
- Damage caused by abuse or careless handling outside of the normal operating procedures contained in this manual.
- Damage from moisture into electrical components.
- Damage from tampering with or removal of any safety device.



### IMPORTANT!

**Keep these instructions for future reference. If the unit changes ownership, be sure this manual accompanies the equipment.**

### IMPORTANT

**The Nieco Corporation reserves the right to change specifications and product design. Such revisions do not entitle the buyer to corresponding changes, improvements, additions or replacements for previously purchased equipment.**

### A.3 Service/Technical Assistance

If you experience any problems with the installation or operation of your broiler, contact your local Authorized Nieco Distributor.

Fill in the information bellow and have it handy when calling your authorized service agency for assistance. The serial number is on the broiler rating plate on the side of the unit.

Purchased from: \_\_\_\_\_

Date of Purchase: \_\_\_\_\_

Model No.: \_\_\_\_\_

Serial No.: \_\_\_\_\_



For the name of your local Authorized Nieco Distributor, please call (800) 821-2141.



Use only genuine Nieco replacement parts in your broiler. Use of replacement parts other than those supplied by Authorized Nieco Distributors and Service Agencies will void the warranty and may significantly alter the performance of your broiler. The use of non-Nieco parts is capable of affecting these criteria, and may affect broiler performance, parts longevity and food safety. Your local Authorized Nieco Distributor and Service Agent has been factory trained and has a complete supply of parts for your Nieco Automatic Broiler.



You may contact the factory direct at (707) 284-7100 if you have trouble locating your local Nieco Distributor.



### A.4 Important Safety Information

Throughout this manual, you will find the following safety words and symbols that signify important safety issues with regards to operating or maintaining the equipment:

|  |
|--|
|  <b>WARNING</b>            |
| <b>GENERAL WARNING.</b> Indicates information important to the proper operation of the equipment. Failure to observe may result in damage to the equipment and/or severe bodily injury or death. |

|  |
|--|
|  <b>WARNING</b>  |
| <b>ELECTRICAL WARNING.</b> Indicates information relating to possible shock hazard. Failure to observe may result in damage to the equipment and/or severe bodily injury or death.         |

|  |
|--|
|  <b>CAUTION</b>  |
| <b>GENERAL CAUTION.</b> Indicates information important to the proper operation of the equipment. Failure to observe may result in damage to the equipment.                            |

|  |
|--|
|  <b>WARNING</b>  |
| <b>HOT SURFACE WARNING.</b> Indicates information important to the handling of equipment and parts. Failure to observe caution could result in personal injury.                            |

## A.4 Important Safety Information (Continued.)

In addition to the warnings and cautions in this manual, use the following guidelines for safe operation of your Nieco Automatic Broiler:

- Read and follow all instructions before using this equipment.
- Install or locate broiler only for its intended use as described in this manual.
- Do not operate this equipment if it has a damaged cord or plug, if it is not working properly or if it has been otherwise damaged.
- This equipment should only be serviced by authorized personnel. Contact your local Nieco Distributor for adjustment or repair.
- Use only genuine Nieco replacement parts for your broiler. Failure to do so will void the warranty and may significantly alter the performance of your broiler. The use of non-Nieco parts is capable of affecting these criteria, and may affect broiler performance, parts longevity and food safety.

**The following warnings and cautions appear throughout the manual and should be carefully observed:**

- **Turn the broiler off, close the main gas valve, and disconnect the plug before performing any service, maintenance or cleaning on the broiler.**
- **Always allow the broiler to fully cool before performing any service, maintenance or cleaning. Failure to wait for the broiler to cool fully may result in personal injury.**
- **The procedures in this manual may include reference to the use of chemical products. The Nieco Corporation does not endorse the use of any particular cleaning/degreasing agent. Use only those chemicals that are approved for use in your restaurant.**
- **The broiler should be grounded according to local electrical codes to prevent the possibility of electrical shock. It requires a grounded receptacle with separate electrical lines, protected by fuses or circuit breakers of the proper rating.**
- **All electrical connections must be in accordance with local electrical codes and any other applicable codes.**
- **The use of adequate ventilation (as rated in this manual) with this broiler is mandatory. Failure to adequately ventilate this unit and provide safe operating distances (as specified in this manual) is a fire safety hazard. Follow the instructions for emergency broiler shutdown in the event of an emergency.**
- **No attempt should be made to operate this appliance in the event of a power failure.**

**WARNING ELECTRICAL SHOCK HAZARD. FAILURE TO FOLLOW THESE INSTRUCTIONS COULD RESULT IN SERIOUS INJURY OR DEATH:**

- **Electrical ground is required on this appliance.**
- **Check with a qualified electrician if you are in doubt as to whether the appliance is properly grounded.**
- **Do not use water on or near the control box for risk of serious injury or death due to electrical shock.**

**WARNING, HIGH TEMPERATURES WITH HOT SURFACES. FAILURE TO FOLLOW THESE PROCEDURES COULD RESULT IN SERIOUS INJURY:**

- **Do not attempt to clean, disassemble or perform maintenance on this broiler until it is fully cooled as per the instructions contained in this manual.**

## B. INSTALLATION

### B.1 Pre-Installation

Uncrate the broiler and inspect for shipping damage. Remove the tape securing the machine parts, and install the parts in their proper location. If there are obvious or concealed damages to any part of the broiler, please contact your freight carrier. The factory warranty does not cover freight damage.

### B.2 Mounting

Follow the mounting instructions if this function is not performed by the installer.

### B.3 Leveling

The grease drain system is based on a gravity-flow design. Therefore, it is extremely important that the broiler be placed on a level surface.

### B.4 Hood Requirements

This appliance must be installed under a ventilation hood of adequate size. Do not obstruct the flow of combustion and ventilation air. An adequate air supply must be available for safe and proper operation.

For installations in the Commonwealth of Massachusetts the following shall apply: Venting shall be in compliance with NFPA Section 10.3.5.2 for the Model JF63.

### B.5 Clearance

Keep appliance area free from combustibles.

To facilitate disassembly and service of the unit a minimum of 24" (610 mm) should be allowed on the control panel (feed end) of the broiler.

#### REQUIRED AND RECOMMENDED CLEARANCES

|                             | <b>REQUIRED</b> for installation near combustible walls and construction | <b>REQUIRED</b> for installation near non-combustible walls and construction | <b>RECOMMENDED</b> by Nieco for proper disassembly and service |
|-----------------------------|--|--|--|
| Back of broiler             | 12" (305 mm)   | 0" (0 mm)  | 0" (0 mm)  |
| Sides of broiler            | 12" (305 mm)   | 0" (0 mm)  | 0" (0 mm)  |
| Front of broiler (Feed end) | 12" (305 mm)   | 0" (0 mm)  | 24" (610 mm)   |



## B.6 Gas Connection- 3/4" N.P.T.

At rated input the gas supply should deliver a minimum pressure of at least 15 mbar (6" water column) at the broiler connection for natural gas. Incoming gas supply pressure must not exceed 50 mbar (14" water column).

**Note:** The installation of this appliance must conform with local codes, or in the absence of local codes, with the National Fuel Gas Code, ANSI Z223.1, Natural Gas Installation Code, CAN/CGA-B149.1 including:

1. The appliance and its individual shutoff valve must be disconnected from the gas supply piping system during any pressure testing of that system at test pressures in excess of 1/2 psi (3.45 kPa).
2. The appliance must be isolated from the gas supply piping system by closing its individual manual shutoff valve during any pressure testing of the gas supply piping system at test pressures equal to or less than 1/2 psi (3.45 kPa).

By public initiative, the State of California has adopted legislation (Proposition 65) which requires manufacturers of many types of products, including gas appliances, to warn consumers of their products that contain chemicals or produce substances listed by the State of California to either cause cancer, birth defects or other reproductive harm.

|   |                |   |
|---|----------------|---|
|    | <b>WARNING</b> |  |
| <b>If not installed, operated and maintained in accordance with the manufacturers instructions, this product could expose you to substances in fuel or from fuel combustion which can cause cancer, birth defects or other reproductive harm.</b> |                |   |

## B.7 Installing Gas Appliance Connectors and Flexible Gas Lines Correctly

For safety in the kitchen area, and to insure maximum service life, it is vitally important to correctly install connectors. The connector shall comply with the Standard for Connectors for Moveable Gas Appliances, ANSI Z21.69 or CAN/CGA-6.16 and a quick disconnect device that complies with the Standard for Quick-Disconnect Devices for use with gas fuel, ANSI Z21.41 or CAN1-6.9

In order to avoid sharp kinks or excessive bends that could have a damaging effect on the connector, it may be necessary to attach pipe elbows in order to bring the connector into its proper plane. For easy movement of the appliance, the connector should be installed with a "lazy" loop for minimum tension.

**Note: Gas appliances should be disconnected prior to maximum movement. (Minimal movement is possible to connect hose.)**

## B.8 Restraining Device Installation and Use

This high strength restrainer is to be used with all moveable (castered) appliances. It fully complies with American Gas Association requirements. References: Z21.69, Z83.11, and Z21.41 with current revisions. Installation is quick and positive. In Canada, device is in accordance with CAN 1-6.9-M70 Quick Disconnect Devices for use with gas fuel, and CAN 1-6.10-88 metal connectors for gas appliances. Correct length for any appliance is simply a matter of loosening two adjuster clips (1) and re-tightening. (3" to 6" shorter than appliance connector is desired length.) Restrainer is made of heavy duty steel cable, with a strong scissor hood (2) at one end, and an equally strong spring hook (3) at the other. Cotter pin (4) is supplied to secure the installation. For proper attachment to the broiler, use the supplied hardware to attach the device to the holes in the shear plate of the broiler stand.

**NOTE: If disconnection of the restraint is necessary, reconnect the restraint after the appliance has been returned to its originally installed position.**

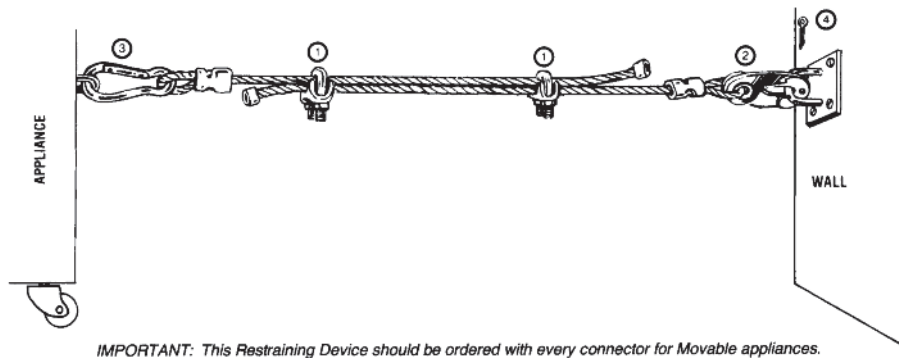

*IMPORTANT: This Restraining Device should be ordered with every connector for Movable appliances.*

## B.9 Electrical Connection

Power requirements are stated on the unit nameplate and must be connected accordingly. This appliance, when installed must be electrically grounded in accordance with local codes, or in the absence of local codes, with the National Electrical Code, ANSI/NFPA 70, or the Canadian Electrical Code, CSA C22.2, as applicable. Before starting broiler, tighten all electrical connections in control box. An electrical wiring diagram can be found inside the control box.

**Note:** Disconnect power before servicing.

## B.10 Pre-Operation Check

Be sure that all parts are installed in the proper location:

- Ventilation is turned on
- Broiler is plugged in
- Gas line is connected

# C. OPERATION

## C.1 Controls and Indicators

On the front of the broiler:

1. Belt Speed Control - Used to set the broil time for the meat belt NOTE: The JF63-2 is equipped with two (2) speed controls).

2. Main On/Off Switch - Turns the broiler on and off.

3. Ignition Failure Light - If flashing, indicates the broiler is no longer lit.

4. Power Indicator Light - Glows green when the power to the broiler is on.

On the side of the broiler:

5. Load Stabilizer Control - Controls the energy input to the broiler when it is under load.

6. Bun Platen Temperature Control - Used to control the temperature of the bun platen.

7. Belt Reverse Button - Push and hold to reverse the direction of the belt to help clear a belt jam. NOTE: The JF63-2-BG is equipped with (2) two buttons.

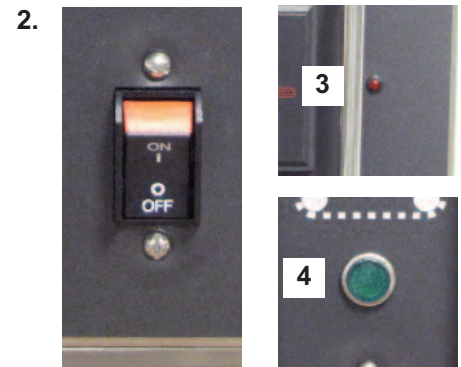

## C. OPERATION

### C.1 Controls and Indicators

6. Multi Product Control (P/N 15161-B) - Used to broil a variety of products that may require different settings (If equipped)



#### MULTI-PRODUCT CONTROL (If equipped)

1. LED DISPLAY - Shows current product selection and cook time.
2. PRODUCT SELECTION BUTTONS - Press to select different presets for different products.
3. ADJUSTMENT BUTTONS - Use to adjust product cook times, element settings and product names.
4. SELECTION INDICATOR LIGHT - Lights up to show which button is selected.

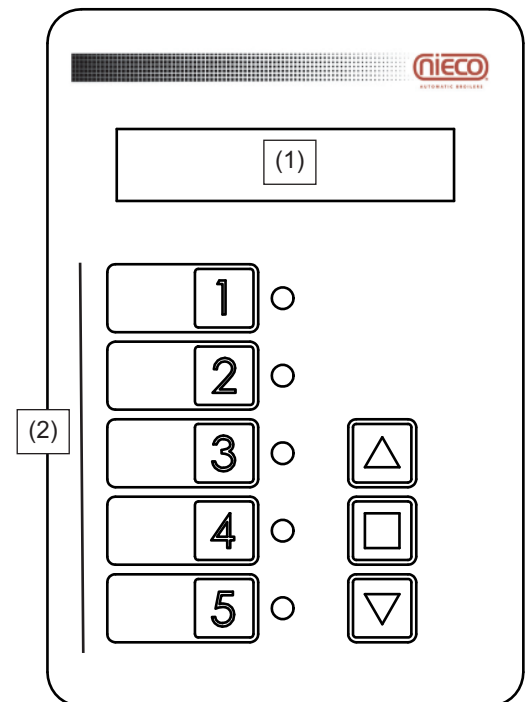

## C.2 Lighting Procedures

### PRE-LIGHTING PREPARATION

1. Broiler is centered under hood and plugged in
2. Gas valve is open when handle is in line (parallel to) the pipe
3. Turn ventilation system on

#### **⚠ WARNING ⚠**

**THE VENTILATION SYSTEM MUST BE ON AT ALL TIMES DURING BROILER OPERATION. OPERATING BROILER WITHOUT PROPER VENTILATION IS A SEVERE FIRE HAZARD.**

### NORMAL IGNITION

The JF63-BG is equipped with automatic ignition. When the broiler is turned on, a hot surface ignitor turns on 5 seconds before the flow of gas. Gas then flows to all of the burners. If the burners are not lit within 10 seconds, the control will reset and try again for 10 seconds. This occurs 3 times. If the broiler does not light after the third attempt, the ignition failure light will flash and the main on/off switch must be cycled to repeat the procedure. If this still doesn't light the broiler, see the MANUAL IGNITION instructions.

1. Turn the **MAIN POWER SWITCH** on.



2. Allow broiler to heat for 45 minutes before cooking.

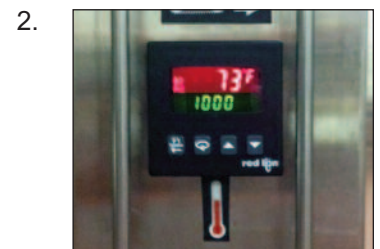

### MANUAL IGNITION

1. Remove the discharge awning. Turn the **MAIN POWER SWITCH** on. Hold a lighter/match to the first upper burner on the discharge end until the burner lights. Once the first burner is lit, verify that all burners have ignited.



## C.3 Shutdown Procedures

### PLANNED SHUTDOWN

1. Allow the broiler to run free of any product for 10 minutes. This will burn the chain clean.
2. Turn off the **Main Power Switch**.
3. Wait for 30 minutes for the broiler to cool.



### EMERGENCY SHUTDOWN

1. Turn off the **MAIN POWER SWITCH**.
2. Close the **MAIN GAS VALVE**. Valve is closed when it is perpendicular to the pipe.



Your Nieco Automatic Broiler is designed to automatically stop gas flow to the broiler in the event of power failure, gas pressure loss or any other related incident. No attempt to operate this appliance should be made in the event of a power failure.

#### **⚠ CAUTION ⚠**

In a prominent location, post instructions to be followed in the event the user smells gas. This information shall be obtained by consulting your local gas supplier.

#### **⚠ CAUTION ⚠**

**FOR YOUR SAFETY:** Do not store or use gasoline or other flammable vapors or liquids in the vicinity of this or any other appliance.

#### **⚠ CAUTION ⚠**

**FOR YOUR SAFETY:** In the event of a prolonged power failure, no attempt should be made to operate this appliance.

## C.4 Control Operation

**IMPORTANT: THIS BROILER IS SHIPPED WITH FACTORY PRESETS THAT MUST BE CHANGED.**

Adjust the broil times for safe cook out of your products. If this is the initial start-up of your broiler, follow the procedures for automatic calibration to properly calibrate the broiler.

### CONTROL OPERATION

#### 1. SETTING BELT SPEEDS

Press up arrow to increase broil time; press the down arrow to decrease broil time. After you have set the control the display will be flashing. Press the center square to save your changes. NOTE: After making changes to the broil time, if you do not press the center square button, your changes will not be saved.

#### 2. LOAD SENSING CONTROL

How it works:

The load sensing control modulates the gas pressure to help keep the broiler stable during cooking.

#### 3. CALIBRATION

Perform calibration in the morning when the broiler is cool.

- Turn the broiler on and set the set point (bottom number on the control) to 1000. Let the broiler warm up for one hour. Do not cook during the warm up period.
- After an hour, push the down arrow to lower the set point to 20° BELOW the actual temperature.
- Your broiler is now calibrated.

#### BUN PLATEN TEMPERATURE CONTROL

To change the set point temperature: Press and hold the center square button for 5 seconds until the control display changes to the flashing set point number. Use the up and down buttons to set the bun platen temperature. After you are done making your changes, press the center square button to save your changes.

The control will then display the new set point for a few seconds, then display the actual temperature.

Under normal operation, when the platen is warming up, the control will display 'Lo', then it will display 'Rdy' when it is ready for use.

Use the up and down arrows to set the time. Press the center square button to save your changes.



Calibration  
Raise the set point temperature to 1000.

Let broiler run for 1 hour.

Lower the set point temperature to 20° BELOW the actual temperature.

Do not cook during calibration.

The numbers on your broiler will be different than those shown here.

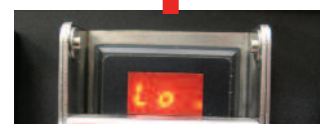

## CONTROL OPERATION

### 1. Multi-Product Control (If equipped)

How it works: The multi-product control is designed to let you broil different products on the flex side of the broiler. The control allows you to have different broiler settings for each product selection button. Use a grease pen to mark the white area with the product name.

### 2. Normal Operation

Press the product selection button (number) for the product you wish to cook. The display will show the product name and cook time and the light next to the product selection button will be lit.

NOTE: Be sure the belt is clear of any products before pressing a new product selection button.

### 3. Changing Belt Speeds

Push the product selection button (a) you want to adjust then push the up and down (b) arrows to make changes, then press the center square button (c) to save them.

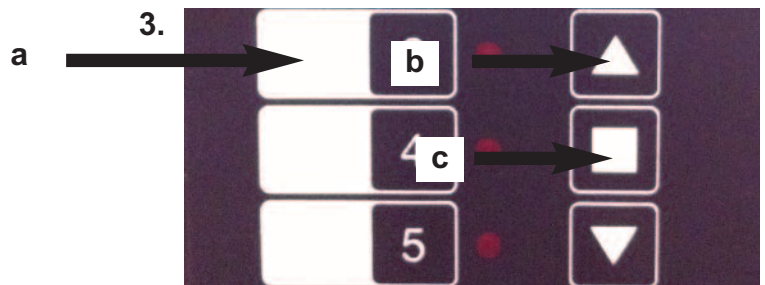

### 4. Changing Product Names

Push the product selection button which you want to make a name to. Press and hold the center square button for 15 seconds. The control will enter the edit name screen for that button. Use the up and down buttons to change the characters. Press center square button once to move to the next character until you are finished editing the product name for that button (10 character limit). Press and hold the PRODUCT SELECTION BUTTON for 5 seconds to save the changes and return to normal operation.

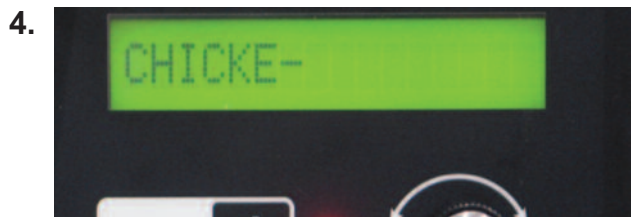

## ADJUSTING THE BUN BELT

Use the adjustment levers to adjust the height of the bun platens. The lever on the right controls the crown side of the bun belt, while the left side control the height of the heel side of the bun belt. Adjust the levers up or down to increase or decrease the height of the bun platen for proper bun grilling.



## D. CLEANING AND DISASSEMBLY

Turn broiler off and close the main gas valve. Disconnect the power supply to the broiler before cleaning or servicing. If this broiler is connected using a restraint, and disconnection of the restraint is necessary for cleaning or moving the broiler, the restraint must be reconnected after the broiler has been returned to its originally installed position. Allow to cool for 30 minutes prior to cleaning/disassembly. Leave the ventilation system on during cooling. Use only approved cleaning, degreasing and sanitizing solutions.

### ⚠ WARNING ⚠

LEAVE THE VENTILATION HOOD ON DURING COOLING. FAILURE TO DO SO COULD POSE A FIRE SAFETY HAZARD.

### ⚠ CAUTION ⚠

Follow the Disassembly and Reassembly steps to ensure proper operation of the broiler. Failure to do so may result in operational problems.

### ⚠ WARNING ⚠

BROILER PARTS ARE HOT. DO NOT ATTEMPT TO DISASSEMBLE THE BROILER UNTIL IT IS FULLY COOL. FAILURE TO FOLLOW THIS INSTRUCTION MAY RESULT IN SEVERE INJURY.

**ALL PARTS ARE CLEANED ON A DAILY BASIS UNLESS OTHERWISE NOTED**

Follow the steps for proper disassembly. Reverse the order for reassembly.

## How to read the cleaning section

The name of the part to be cleaned.

The location of the part.

When to clean the part.

The tools needed to clean the part

How to remove and clean the parts.

Picture of the part to be removed and cleaned.

The diagram shows a broiler's internal components. A red circle highlights 'Meat Guides' at the top left. A red circle highlights 'Tools' in the middle left, which includes a '3 Compartment Sink' and a 'Scrub Pad'. A red circle highlights 'Instructions' at the bottom left, with two numbered steps: '1 Pull each meat guide out slightly from the bottom, then lift off.' and '2 Wash, rinse, and sanitize in the 3-compartment sink.' A red circle highlights 'Feed End' at the top center. A red circle highlights 'Clean: Every 4 hours' at the top right. A photograph on the right shows a hand pulling a metal meat guide out of the broiler, with a red arrow pointing to it from the text 'Picture of the part to be removed and cleaned.'

# Cleaning the Broiler



## Tools Needed

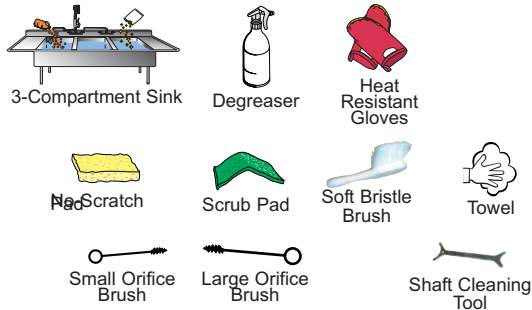

**STOP**

## Important Symbols



This “Stop” sign shows a step in the procedure that must be followed exactly or personal safety could be affected.



This warning symbol shows a step in the procedure that must be followed exactly or broiler performance could be affected.



This “puzzle” symbol shows a step in the reassembly procedure that must be followed.



## Instructions

1. Allow the broiler to run free of product for 10 minutes before turning it off. This allows any residue to burn off the chains.
2. Shut the broiler off and let it cool for 30 minutes before disassembly and cleaning.
3. Close the main gas valve and unplug the broiler before cleaning.
4. Always leave the ventilation hood on during the 30 minute cool down period.
5. Use only approved cleaning solutions.
6. Allow parts to air dry after cleaning.

# Meat Guide(s) (If equipped)

**Clean: Every 4 hours**



## Tools

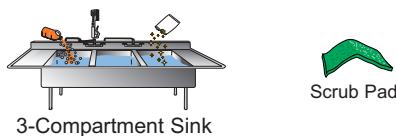

## Instructions

1. Lift the meat guides up and off the feeder.
2. Wash, rinse, and sanitize in the 3-compartment sink.

## Feed End



## Feeder Cover

Clean: Every 4 hours



### Tools

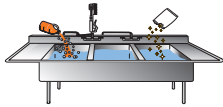

3-Compartment Sink



Scrub Pad



### Instructions

1. Slide the feeder cover towards you until it comes off.
2. Wash, rinse, and sanitize in the 3-compartment sink.

### Feed End



## Wire Belt Feeder Base (If equipped)

Clean: Every 4 hours



### Tools

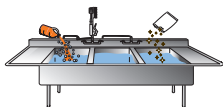

3-Compartment Sink



Scrub Pad



### Instructions

1. Pull the release pin.
2. Lift wire belt feeder bases up and off.
3. Wash, rinse, and sanitize in the 3-compartment sink.

 **REASSEMBLY:** Pull the release pin and place feeder base in position.

### Feed End



## Push Bar Feeder Base (If equipped)

Clean: Every 4 hours



### Tools

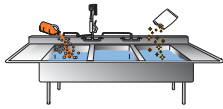

3-Compartment Sink



Scrub Pad



### Instructions

1. Pull the release pin.
2. Lift push bar and wire belt feeder bases up and off.
3. Wash, rinse, and sanitize in the 3-compartment sink.

 **DO NOT** lift the feeder base by the feeder bar or the chains. This will damage the feeder base.

 **REASSEMBLY:** Pull the release pin and place feeder base in position.

### Feed End



## Feeder Housing

Clean: Daily



### Tools

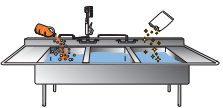

3-Compartment Sink



Scrub Pad



### Instructions

1. Lift and remove.
2. Wash, rinse, and sanitize in the 3-compartment sink.

 **REASSEMBLY:** Hang feeder housing on brackets.

### Feed End



## Grease Pan

Clean: Daily



### Tools



Heat Resistant Gloves



Scrub Pad



Degreaser

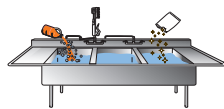

3-Compartment Sink



### Instructions

1. Slide grease pan out.

**!** Make sure grease pan is cool before putting in water or it may warp the pans.

2. Take to sink area and spray with degreaser.
3. Wash with a scrub pad, rinse, and sanitize in the 3-compartment sink.

### Feed End



## Wipe PTFE Sheets

Clean: Daily



### Tools

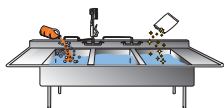

3-Compartment Sink



Scrub Pad



### Instructions

1. Slide the sheet out from under the bun platen.
2. Using a clean, damp cloth, wipe the sheet clean.

**+** REASSEMBLY: Slide the sheet back under the bun platen.

### Feed End



## Crumb Tray

Clean: Daily



### Tools

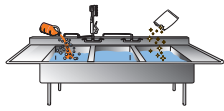

3-Compartment Sink



Scrub Pad



### Instructions

1. Slide out from under bun belt.
2. Wash, rinse, and sanitize in the 3-compartment sink.

### Feed End



## Feed End Heat Shield

Clean: As needed



### Tools



Heat Resistant Gloves



Scrub Pad



Degreaser

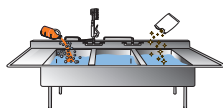

3-Compartment Sink



### Instructions

1. Lift up and off.
2. Take to sink area and spray with degreaser.
3. Wash, rinse, and sanitize in the 3-compartment sink.

### Feed End



## Discharge Heat Shield

Clean: Daily



### Tools



Heat Resistant Gloves



Scrub Pad



Degreaser

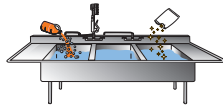

3-Compartment Sink



### Instructions

1. Lift up and off.
2. Take to sink area and spray with degreaser.
3. Wash, rinse, and sanitize in the 3-compartment sink.

### Discharge End

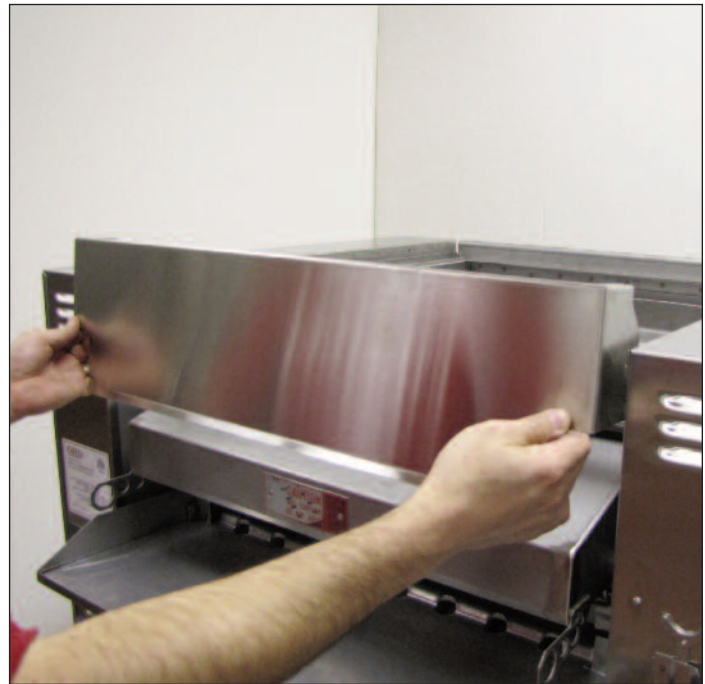

## Discharge Awning

Clean: Daily



### Tools



Heat Resistant Gloves



Scrub Pad



Degreaser

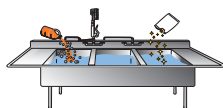

3-Compartment Sink



### Instructions

1. Lift up and off.
2. Take to sink area and spray with degreaser.
3. Wash, rinse, and sanitize in the 3-compartment sink.

### Discharge End



## Sizzle Plate/Catch Pan Insert (If equipped)

Clean: Daily



### Tools



Heat Resistant Gloves



Scrub Pad



Degreaser

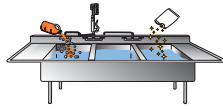

3-Compartment Sink



### Instructions

1. Lift sizzle plate or catch pan insert up and off.
2. Take to sink area and spray with degreaser.
3. Wash, rinse, and sanitize in the 3-compartment sink.

NOTE: Your broiler will be equipped with one or the other.

### Discharge End



## Patty Catch Pan

Clean: Daily



### Tools



Heat Resistant Gloves



Scrub Pad



Degreaser

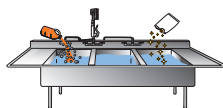

3-Compartment Sink



### Instructions

1. Lift up and off.
2. Take to sink area and spray with degreaser.
3. Wash, rinse, and sanitize in the 3-compartment sink.

### Discharge End



## Stripper Blade

Clean: Daily



### Tools



Heat Resistant Gloves



Scrub Pad



Degreaser

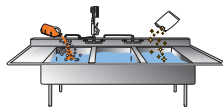

3-Compartment Sink



### Instructions

1. Tilt stripper blade away from chain; lift off brackets.

**!** Make sure stripper blade is cool before putting in water or it may warp.

2. Take to sink area and spray with degreaser.
3. Wash with a scrub pad, rinse, and sanitize in the 3-compartment sink.

**+** REASSEMBLY: Hang stripper blade on brackets.

### Discharge End

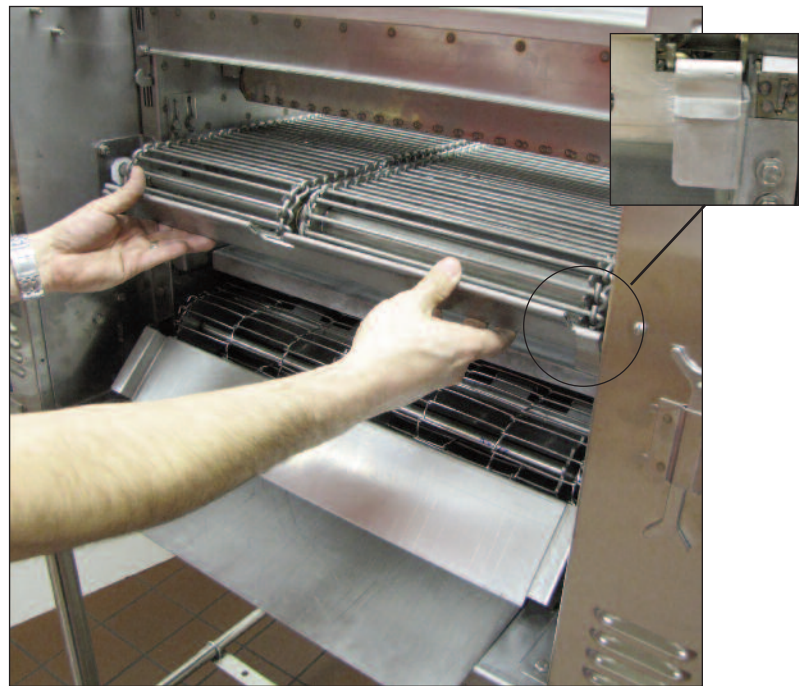

## Bun Blade

Clean: Daily



### Tools



Heat Resistant Gloves



Scrub Pad



Degreaser

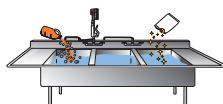

3-Compartment Sink



### Instructions

1. Lift up and off.
2. Take to sink area and spray with degreaser.
3. Wash, rinse, and sanitize in the 3-compartment sink.

### Discharge End



## Grease Box

Clean: Daily



### Tools



Scrub Pad



Degreaser

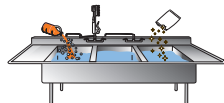

3-Compartment Sink



### Instructions

1. Lift grease box off.
2. Take to sink area and spray with degreaser.
3. Wash with a scrub pad, rinse, and sanitize in the 3-compartment sink.

 **REASSEMBLY:** Put grease box on before the grease trough.

**NOTE:** If your broiler is on legs and not a stand your grease box will be as shown in picture two.

### Side



## Lower Burner

Clean: Daily



### Tools



Heat Resistant Gloves

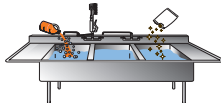

3-Compartment Sink





Scrub Pad



### Instructions

1. Lift the burner latch.
2. Slide burner out.
3. Take to the 3-compartment sink and scrub with a scrub pad or nylon brush.
4. If necessary, use a stiff toothbrush to clean any clogged burner holes.

 **REASSEMBLY:** Be sure the holes on the burner are facing up.

 **Burner must be completely dry before reassembly. Dry with a paper towel.**

### Side



## Incendalyst™ (If no perforated cap)

Clean: Daily



### Tools



Heat Resistant Gloves



### Instructions



**EXTREMELY HOT!** Be careful not to burn yourself.

1. Grasp handle and lift Catalyst off to remove from shroud.
2. SOAK IN WARM WATER FOR 1 HOUR. RINSE WITH WATER ONLY. NEVER USE ANY CHEMICALS ON THE CATALYST.
3. Lay flat to drain water and let air dry overnight.
4. Make sure catalyst is dry before putting back on broiler.

### Top

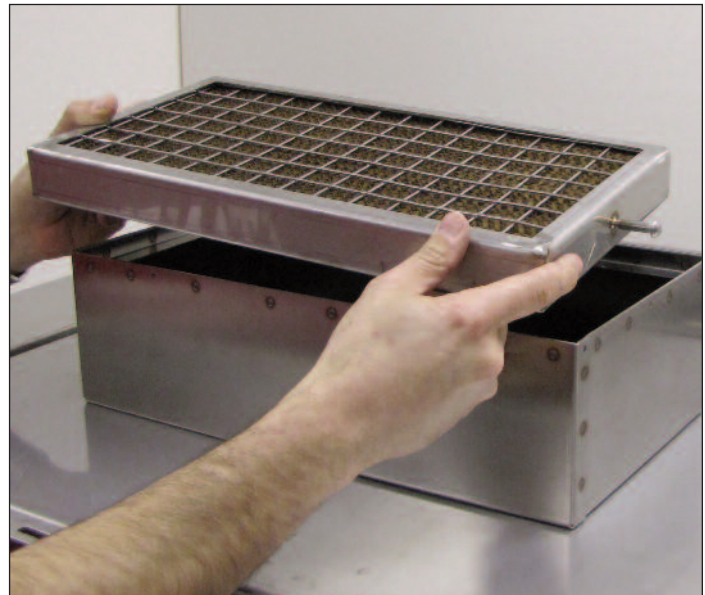

CAUTION:  
Extremely Hot



## Perforated Cap (if no Incendalyst™)

Clean: Daily



### Tools



Heat Resistant Gloves



### Instructions



**EXTREMELY HOT!** Be careful not to burn yourself.

1. Lift cap from shroud collar.
2. Take to sink area and spray with degreaser.
3. Wash with a scrub pad, rinse, and sanitize in the 3-compartment sink.

### Top

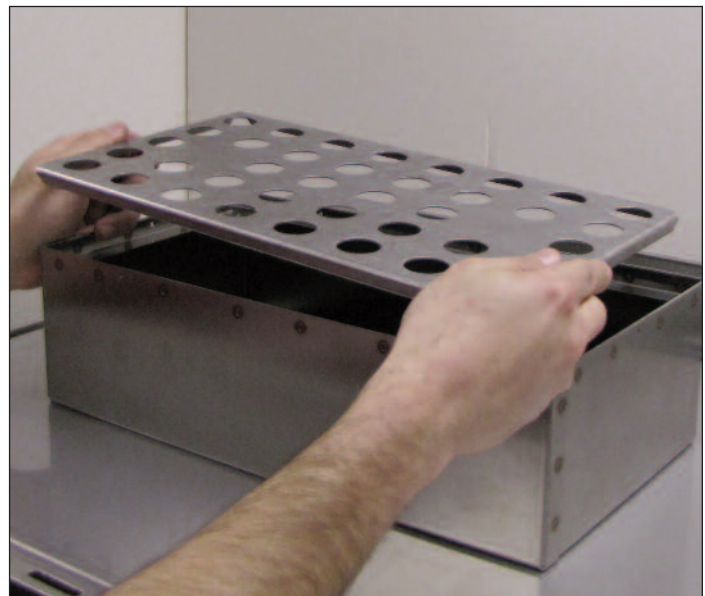

CAUTION:  
Extremely Hot



# Chimney

Clean: Monthly



## Tools



Heat Resistant Gloves



Scrub Pad



Degreaser

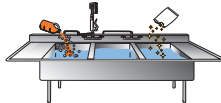

3-Compartment Sink



## Instructions



**EXTREMELY HOT!** Be careful not to burn yourself.

1. Lift Incendalyst™ chimney up and off.
2. Take to sink area and spray with degreaser.
3. Wash with a scrub pad, rinse, and sanitize in the 3-compartment sink.

## Top

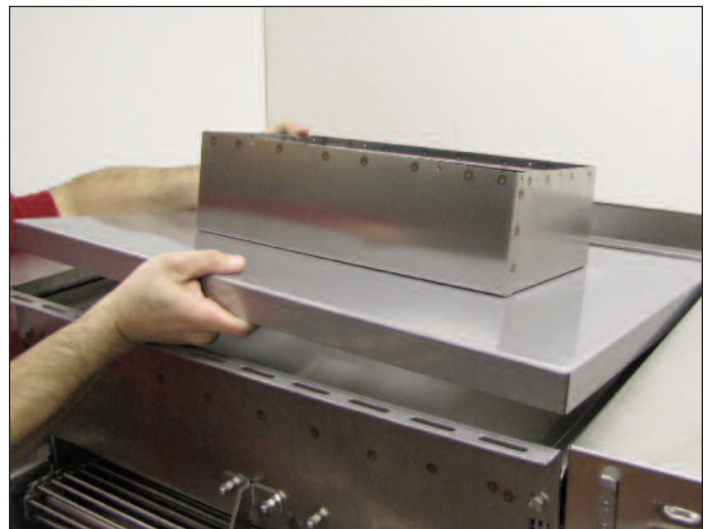

CAUTION:  
Extremely Hot



# Upper Heat Shield

Clean: Monthly



## Tools



Heat Resistant Gloves



Scrub Pad



Degreaser

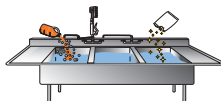

3-Compartment Sink



## Instructions



**EXTREMELY HOT!** Be careful not to burn yourself.

1. Lift upper heat shield up and off.
2. Take to sink area and spray with degreaser.
3. Wash with a scrub pad, rinse, and sanitize in the 3-compartment sink.

## Top

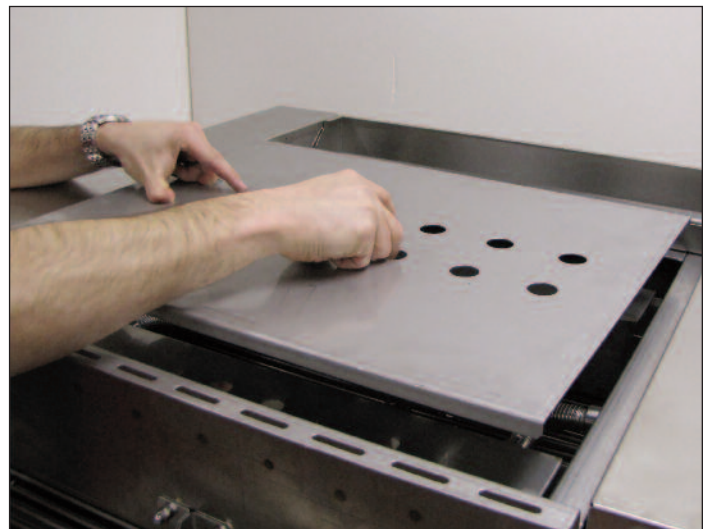

CAUTION:  
Extremely Hot



## Upper Burner/Air Box

Clean: Monthly



### Tools



Heat Resistant Gloves

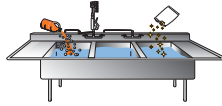

3-Compartment Sink



Scrub Pad



### Instructions

1. Lift air upper burner and air box from the top of the broiler. It is not necessary to detach them.
2. Use a stiff brush to clean any clogged burner holes.



Be sure that both air box assemblies are installed and sit flush on their brackets.

### Top

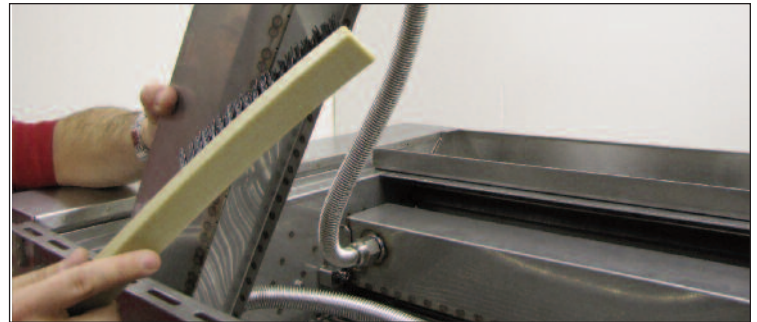

## Main Burner Orifices

Clean: Monthly



### Tools



Small Orifice  
Brush



### Instructions

1. Use a small brush to clean the main burner orifices.

### Side

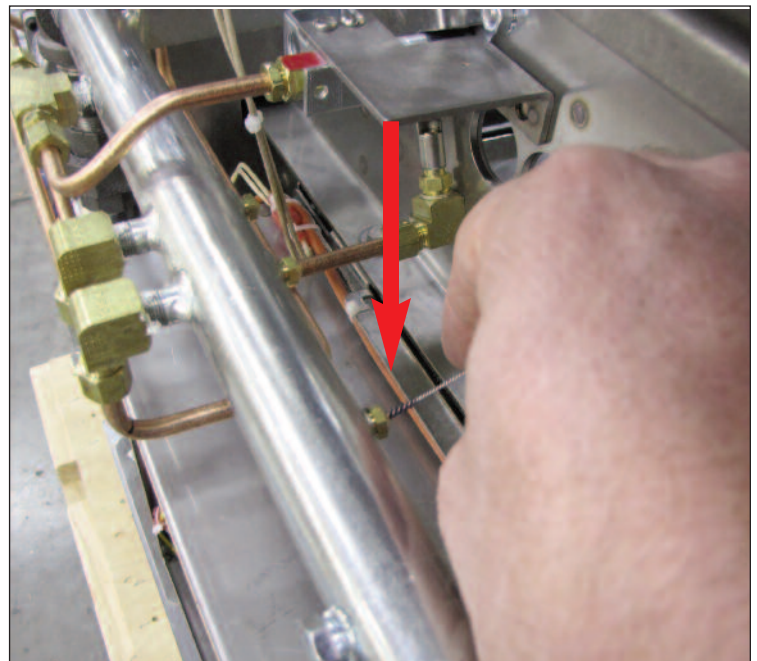

## Pilot Orifices

Clean: Monthly



### Tools



Flat Head  
Screwdriver



### Instructions

1. Use a flat head screwdriver or box cutter to clean the slots on the pilot orifices.

### Interior

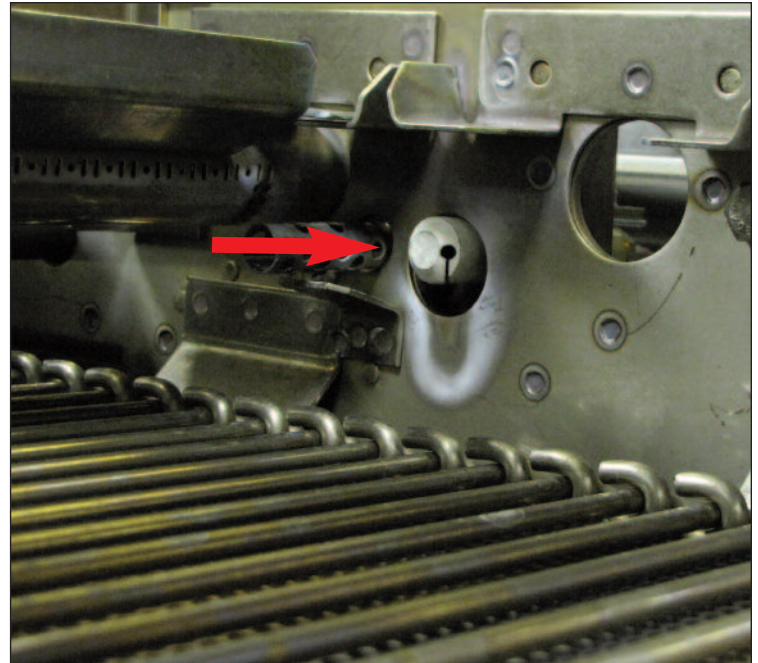

## Flame Sensor

Clean: Monthly



### Tools



Scrub Pad



### Instructions

1. Remove the left side control box cover.
2. Remove the ceramic boot from the back of the flame sensor.
3. Loosen the wing nut holding the flame sensor in place.
4. Remove the flame sensor and clean the metal tip with a DRY, clean scrub pad.

### Side



# Inner Shield

Clean: Monthly



## Tools



## Instructions

1. Use scraping tool to reach between belts and remove carbon deposits.





## Tools



Shaft Cleaning Tool



## Instructions

1. Scrape each shaft of both belts on the discharge end with the wide end of the shaft cleaning tool. The tool is located on the clip on the back of the broiler.
2. Wipe shaft cleaning tool with a towel.

## Discharge End



# Belt Adjustment



## Tools



## Instructions

1. Remove return slide and stripper bar.
2. Loosen slotted crossbar bracket with 7/16 wrench.
3. Pry on shaft to adjust belt.
4. Tighten bolts.



## E. TROUBLESHOOTING

**Always verify that the broiler is properly assembled, the hood is on, gas valve open and broiler is plugged in.**

|  |   |
|--|---|
| No power to broiler when the switch is turned on.                    | Check: Broiler is plugged in.<br>Ventilation hood is on.<br>Circuit Breaker on wall panel is on.  |
| Broiler has power, but the burners do not light.                     | Check: Ventilation hood is on.<br>Gas line is properly plugged in.<br>Manual gas valve (if equipped) is on.<br>Burners are installed properly.<br>Burners are clean and dry.<br>Flame sensor wire connection.<br>Follow manual lighting instructions. |
| Red light blinking on left control box.                              | Check the items above for burners not lighting.<br>Turn power off and on again to reset ignition.<br>Follow manual lighting instructions.   |
| Hot surface ignitor does not heat.                                   | Check for loose wires connecting the hot surface ignitor.<br>Follow manual lighting instructions.   |
| Power is on, broiler is lit, but the conveyor belts are not turning. | Check for a jam in the conveyor belt. Check the stripper blade and the flame arrestors to make sure they are installed properly.  |
| Feeder belt not moving.  | Make sure the feeder is assembled properly.<br>Check for jam.<br>Make sure the drive pin is engaged.  |
| Feeder jams.   | Make sure the burgers are not frozen together.  |
| Burgers sticking to slide or stripper blade.                         | Clean the slide and stripper blade very thoroughly.<br>Check cookout temperature (undercooking).  |
| <b>COOKING PROBLEMS</b><br>Burgers under or over cooked.             | Adjust conveyor belt speed.<br>Clean burners and orifices.  |
| Excessive flaming in broiler.  | Clean the catalyst if equipped.<br>Check the hood for proper operation.<br>Check product for overcooking.   |

# F. WIRING DIAGRAM

| REV. | DESCRIPTION           | DATE      | BY |
|------|-----------------------|-----------|----|
| A    | Initial Release       | 15-Feb-12 | KK |
| B    | Changed to 18V blower | 15-Mar-12 | KK |

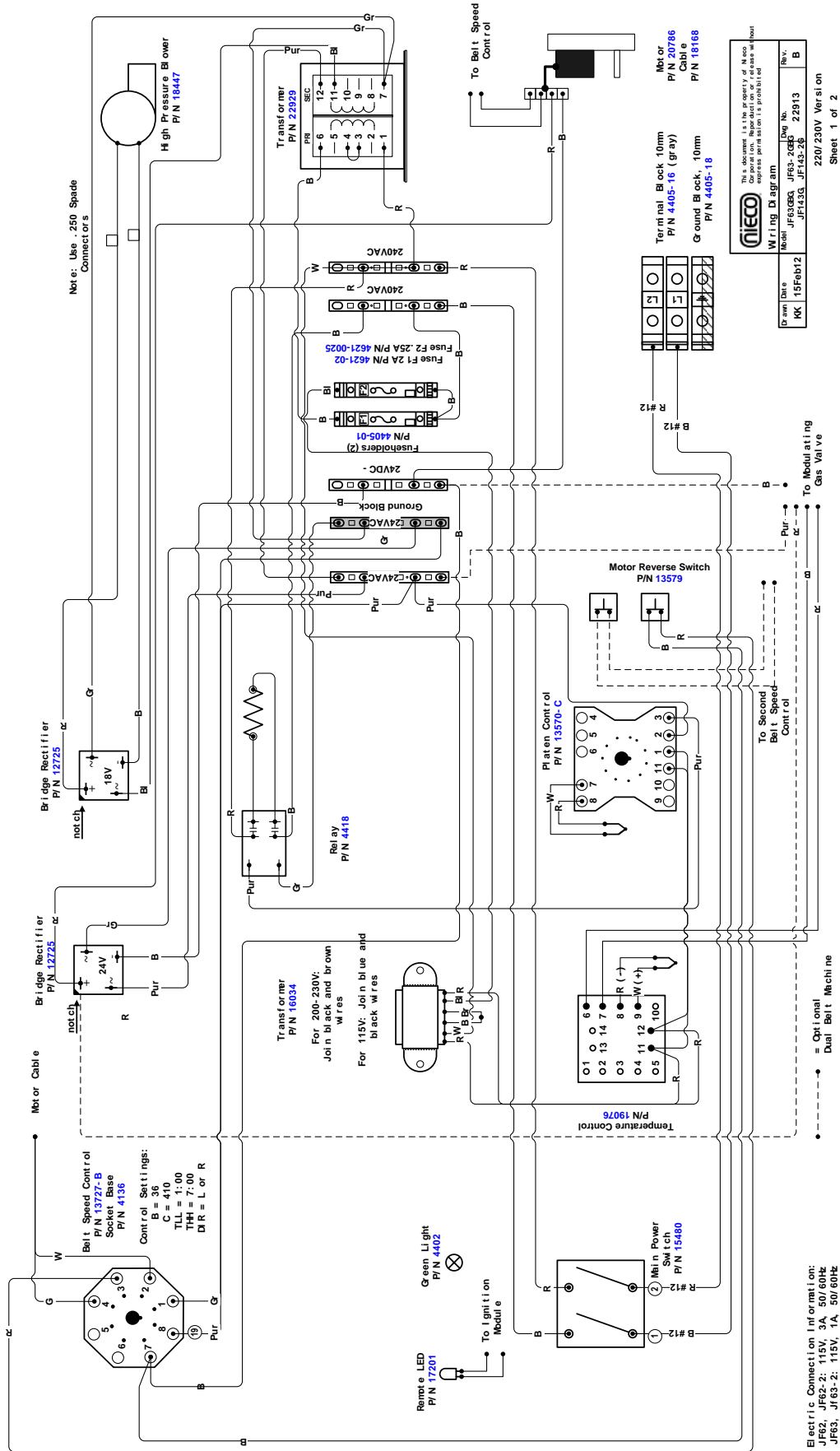

**NIICO**

This document is the property of Nioco Corporation. Reproduction or further dissemination in any form without express permission is prohibited.

Drawn (Rev) KK 15Feb12  
Wiring Diagram  
Motor JF63BG, JF63-2GB  
Cable JF153C, JF143-2B

Rev No. 22013  
Rev. B

220/230V Version  
Sheet 1 of 2

Electric Connection Information:  
JF62, JF63-2: 115V, 3A, 50/60Hz  
JF63, JF63-2: 115V, 1A, 50/60Hz



# F. WIRING DIAGRAM

Manifold Side Control Box

..... = Optional  
Dual Belt Machine

Optional Second Motor  
For JF62-2 and 63-2

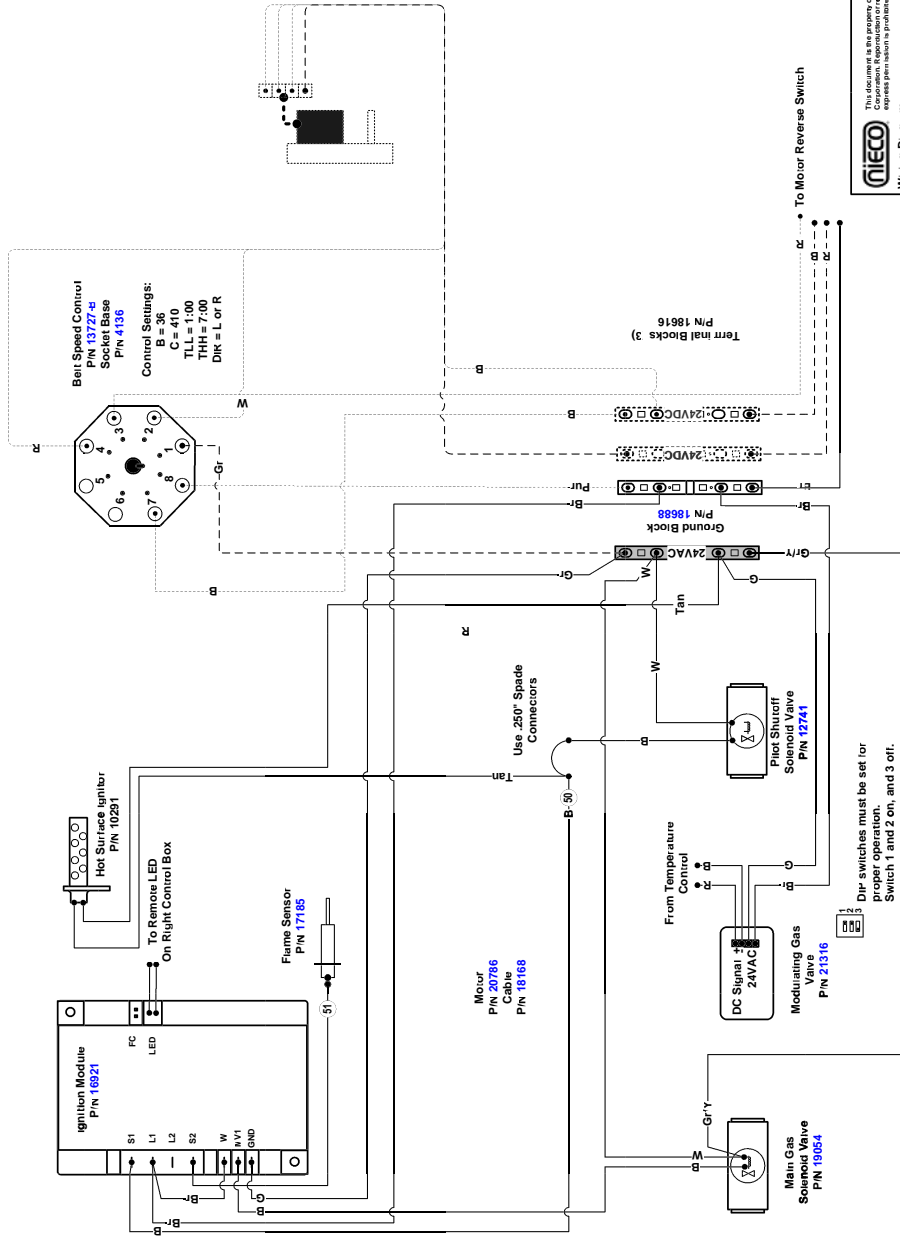

|              |                               |   |       |
|--------------|-------------------------------|---|-------|
| <b>niECO</b> |                               | This document is the property of Nieco Corporation. It is to be used only for the equipment and location specified. No other use without express permission is permitted. |       |
| Model        | JF63BG, JF63GB1, JF63B, JF62B | Dwg. No.  | 22913 |
| Drawn        | KK                            | 15Feb12   |       |
| Rev.         |                               |   | B     |

Sheet 2 of 2



# G. SPECIFICATIONS

## AUTOMATIC BROILER

Model JF63-BG

| DIMENSIONS        | Inches | mm   |
|-------------------|--------|------|
| Length            | 42.34  | 1075 |
| Height (on stand) | 57.62  | 1463 |
| Width             | 34.73  | 882  |

### ENERGY

Gas Models, Natural or LPG:

Average usage:

45,000 BTU/hour; 11,347 Kcal

Connection size: 3/4" NPT

Electric connection: 208V 10.8A 1Ø

### WEIGHT

350 lbs 158 Kg

### OPTIONS

Legs (no stand)

Spare parts kit

Dual Belt

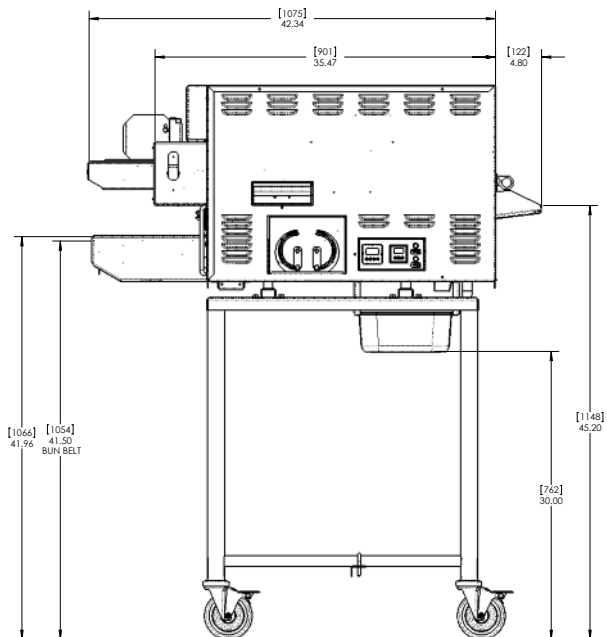
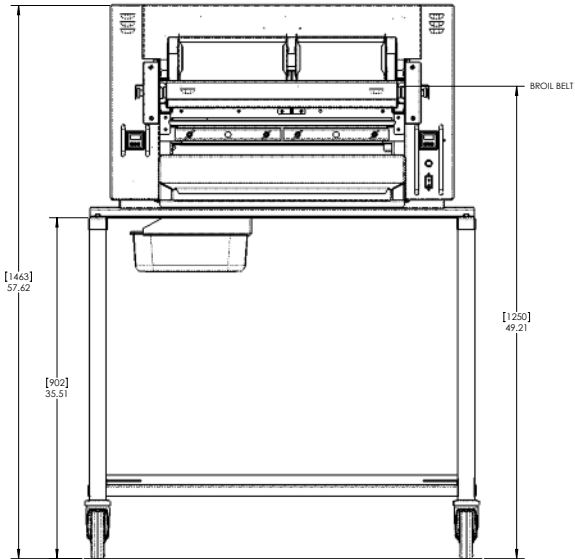

**⚠ CAUTION ⚠**

All electrical connections must be in accordance with local electrical codes and any other applicable codes.

**⚠ CAUTION ⚠**

Do not operate the broiler at gas pressures other than those stated here. Doing so will affect the operation of your broiler.

Revision History:

| Date      | Notes  | REV |
|-----------|--|-----|
| 9-21-2011 | Released   | A   |
| 4-17-2012 | Updated: Wiring diagrams; control instructions; cleaning instructions; troubleshooting | B   |
|           |  |     |



**Nieco Corporation**

7950 Cameron Drive

Windsor, CA 95492

(707) 284-7100 Office • (707) 284-7430 Fax

[www.nieco.com](http://www.nieco.com) • e-mail: [service@nieco.com](mailto:service@nieco.com)

Printed in the USA © 2011 Nieco Corporation All Rights Reserved  
Reorder P/N 99010