



Model MPB73 Owner's Manual



APPROVALS:



FOR YOUR SAFETY:

Do not store or use gasoline or other flammable vapors or liquids in the vicinity of this or any other appliance.

WARNING:

Improper installation, adjustment, alteration, maintenance can cause property damage, injury, or death. Read the installation, operating and maintenance instructions thoroughly before installing or servicing this equipment.

Broiler area must be kept free of combustible materials, and the flow of combustion and ventilation air must not be obstructed. Operating personnel must not perform any maintenance or repair functions. Contact your Nieco Authorized Dealer.

IMPORTANT: RETAIN THIS MANUAL IN A SAFE PLACE FOR FUTURE REFERENCE

TABLE OF CONTENTS

A. General Information	3
A.1 Description	3
A.2 Warranty Information	3
A.3 Service/Technical Assistance	4
A.4 Safety Information	4
B. Machine Installation	6
B.1 Pre-Installation	6
B.2 Mounting	6
B.3 Leveling	6
B.4 Hood Requirements	6
B.5 Clearance	6
B.6 Gas Connection	7
B.7 Flexible Gas Line Installation	7
B.8 Restraining Device	8
B.9 Electrical Connection	8
B.10 Pre-Operation Check	8
C. Operation	9
C.1 Controls and Indicators	9
C.2 Step-by-Step Lighting Procedure	11
C.3 Shutdown Procedure	12
C.4 Control Operation	12
D. Assembly/Disassembly and Cleaning	13
E. Troubleshooting Guide	24
F. Parts Location Drawings	25
G. Specifications	27

A. GENERAL INFORMATION

A.1 Description

The Nieco® Model MPB73 automatic broiler features high release convection burners, electric elements, a new, simplified ignition system, easy cleaning and a simple and intuitive control package to help eliminate broiling problems and provide the operator with even greater control over the broiling environment.

This manual provides the safety, installation and operating procedures for the Nieco Automatic Broiler Model MPB73. We recommend that all information contained in this manual be read prior to installing and operating the broiler.



A.2 Warranty Information

Please read the full text of the limited Warranty in this manual.

If the unit arrives damaged, contact the carrier immediately and file a damage claim with them. Save all packing materials when filing a claim. Freight damage claims are the responsibility of the purchaser and **ARE NOT** covered under warranty.

The warranty **does not** extend to:

- Damages caused in shipment or damage as a result of improper use.
- Installation of electrical service.
- Normal maintenance as outlined in this manual.
- Malfunction resulting from improper maintenance not in accordance with the steps contained in this manual and any applicable training.
- Damage caused by abuse or careless handling outside of the normal operating procedures contained in this manual.
- Damage from moisture into electrical components.
- Damage from tampering with or removal of any safety device.

IMPORTANT!

Keep these instructions for future reference. If the unit changes ownership, be sure this manual accompanies the equipment.

IMPORTANT

The Nieco Corporation reserves the right to change specifications and product design. Such revisions do not entitle the buyer to corresponding changes, improvements, additions or replacements for previously purchased equipment.

A.3 Service/Technical Assistance

If you experience any problems with the installation or operation of your broiler, contact your local Authorized Nieco Distributor.

Fill in the information bellow and have it handy when calling your authorized service agency for assistance. The serial number is on the broiler rating plate on the side of the unit.

Purchased from: _____

Date of Purchase: _____

Model No.: _____

Serial No.: _____



For the name of your local Authorized Nieco Distributor, please call (800) 821-2141.



Use only genuine Nieco replacement parts in your broiler. Use of replacement parts other than those supplied by Authorized Nieco Distributors and Service Agencies will void the warranty and may significantly alter the performance of your broiler. The use of non-Nieco parts is capable of affecting these criteria, and may affect broiler performance, parts longevity and food safety. Your local Authorized Nieco Distributor and Service Agent has been factory trained and has a complete supply of parts for your Nieco Automatic Broiler.



You may contact the factory direct at (707) 284-7100 if you have trouble locating your local Nieco Distributor.



A.4 Important Safety Information

Throughout this manual, you will find the following safety words and symbols that signify important safety issues with regards to operating or maintaining the equipment:

 WARNING 
GENERAL WARNING. Indicates information important to the proper operation of the equipment. Failure to observe may result in damage to the equipment and/or severe bodily injury or death.

 WARNING 
ELECTRICAL WARNING. Indicates information relating to possible shock hazard. Failure to observe may result in damage to the equipment and/or severe bodily injury or death.

 CAUTION 
GENERAL CAUTION. Indicates information important to the proper operation of the equipment. Failure to observe may result in damage to the equipment.

 WARNING 
HOT SURFACE WARNING. Indicates information important to the handling of equipment and parts. Failure to observe caution could result in personal injury.

A.4 Important Safety Information (Continued)

In addition to the warnings and cautions in this manual, use the following guidelines for safe operation of your Nieco Automatic Broiler:

- Read and follow all instructions before using this equipment.
- Install or locate broiler only for its intended use as described in this manual.
- Do not operate this equipment if it has a damaged cord or plug, if it is not working properly or if it has been otherwise damaged.
- This equipment should only be serviced by authorized personnel. Contact your local Nieco Distributor for adjustment or repair.
- Use only genuine Nieco replacement parts for your broiler. Failure to do so will void the warranty and may significantly alter the performance of your broiler. The use of non-Nieco parts is capable of affecting these criteria, and may affect broiler performance, parts longevity and food safety.

The following warnings and cautions appear throughout the manual and should be carefully observed:

- **Turn the broiler off, close the main gas valve, and disconnect the plug before performing any service, maintenance or cleaning on the broiler.**
- **Always allow the broiler to fully cool before performing any service, maintenance or cleaning. Failure to wait for the broiler to cool fully may result in personal injury.**
- **The procedures in this manual may include reference to the use of chemical products. The Nieco Corporation does not endorse the use of any particular cleaning/degreasing agent. Use only those chemicals that are approved for use your kitchen.**
- **The broiler should be grounded according to local electrical codes to prevent the possibility of electrical shock. It requires a grounded receptacle with separate electrical lines, protected by fuses or circuit breakers of the proper rating.**
- **All electrical connections must be in accordance with local electrical codes and any other applicable codes.**
- **The use of adequate ventilation (as rated in this manual) with this broiler is mandatory. Failure to adequately ventilate this unit and provide safe operating distances (as specified in this manual) is a fire safety hazard. Follow the instructions for emergency broiler shutdown in the event of an emergency.**
- **No attempt should be made to operate this appliance in the event of a power failure.**

WARNING ELECTRICAL SHOCK HAZARD. FAILURE TO FOLLOW THESE INSTRUCTIONS COULD RESULT IN SERIOUS INJURY OR DEATH:

- **Electrical ground is required on this appliance.**
- **Check with a qualified electrician if you are in doubt as to whether the appliance is properly grounded.**
- **Do not use water on or near the control box for risk of serious injury or death due to electrical shock.**

WARNING, HIGH TEMPERATURES WITH HOT SURFACES. FAILURE TO FOLLOW THESE PROCEDURES COULD RESULT IN SERIOUS INJURY:

- **Do not attempt to clean, disassemble or perform maintenance on this broiler until it is fully cooled as per the instructions contained in this manual.**

B. INSTALLATION

B.1 Pre-Installation

Uncrate the broiler and inspect for shipping damage. Remove the tape securing the machine parts, and install the parts in their proper location. If there are obvious or concealed damages to any part of the broiler, please contact your freight carrier. The factory warranty does not cover freight damage.

B.2 Mounting

Follow the mounting instructions if this function is not performed by the installer.

B.3 Leveling

The grease drain system is based on a gravity-flow design. Therefore, it is extremely important that the broiler be placed on a level surface.

B.4 Hood Requirements

This appliance must be installed under a ventilation hood of adequate size and the following minimum capacity:

Do not obstruct the flow of combustion and ventilation air. An adequate air supply must be available for safe and proper operation.

For installations in the Commonwealth of Massachusetts the following shall apply: Venting shall be in compliance with NFPA Section 10.3.5.2 for the Model MPB84.

B.5 Clearance

Keep appliance area free from combustibles.

To facilitate disassembly and service of the unit a minimum of 24" (610 mm) should be allowed on the control panel (feed end) of the broiler.

REQUIRED AND RECOMMENDED CLEARANCES

	REQUIRED for installation near combustible walls and construction	REQUIRED for installation near non-combustible walls and construction	RECOMMENDED by Nieco for proper disassembly and service
Back of broiler	12" (305 mm)	0" (0 mm)	0" (0 mm)
Sides of broiler	12" (305 mm)	0" (0 mm)	0" (0 mm)
Front of broiler (Feed end)	12" (305 mm)	0" (0 mm)	24" (610 mm)

B.6 Gas Connection- 3/4" N.P.T.

At rated input the gas supply should deliver a minimum pressure of at least 15 mbar (6" water column) at the broiler connection for natural gas. Incoming gas supply pressure must not exceed 50 mbar (14" water column).

Note: The installation of this appliance must conform with local codes, or in the absence of local codes, with the National Fuel Gas Code, ANSI Z223.1, Natural Gas Installation Code, CAN/CGA-B149.1 including:

1. The appliance and its individual shutoff valve must be disconnected from the gas supply piping system during any pressure testing of that system at test pressures in excess of 1/2 psi (3.45 kPa).
2. The appliance must be isolated from the gas supply piping system by closing its individual manual shutoff valve during any pressure testing of the gas supply piping system at test pressures equal to or less than 1/2 psi (3.45 kPa).

B.7 Installing Gas Appliance Connectors and Flexible Gas Lines Correctly

For safety in the kitchen area, and to insure maximum service life, it is vitally important to correctly install connectors. The connector shall comply with the Standard for Connectors for Moveable Gas Appliances, ANSI Z21.69 or CAN/CGA-6.16 and a quick disconnect device that complies with the Standard for Quick-Disconnect Devices for use with gas fuel, ANSI Z21.41 or CAN1-6.9

In order to avoid sharp kinks or excessive bends that could have a damaging effect on the connector, it may be necessary to attach pipe elbows in order to bring the connector into its proper plane. For easy movement of the appliance, the connector should be installed with a "lazy" loop for minimum tension.

Note: Gas appliances should be disconnected prior to maximum movement. (Minimal movement is possible to connect hose.)

B.8 Restraining Device Installation and Use

This high strength restrainer is to be used with all moveable (castered) appliances. It fully complies with American Gas Association requirements. References: Z21.69, Z83.11, and Z21.41 with current revisions. Installation is quick and positive. In Canada, device is in accordance with CAN 1-6.9-M70 Quick Disconnect Devices for use with gas fuel, and CAN 1-6.10-88 metal connectors for gas appliances. Correct length for any appliance is simply a matter of loosening two adjuster clips (1) and re-tightening. (3" to 6" shorter than appliance connector is desired length.) Restrainer is made of heavy duty steel cable, with a strong scissor hood (2) at one end, and an equally strong spring hook (3) at the other. Cotter pin (4) is supplied to secure the installation. For proper attachment to the broiler, use the supplied hardware to attach the device to the holes in the shear plate of the broiler stand.

NOTE: If disconnection of the restraint is necessary, reconnect the restraint after the appliance has been returned to its originally installed position.

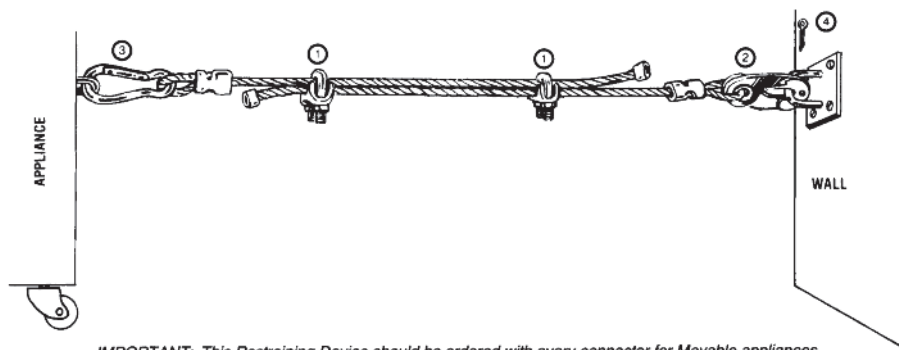

B.9 Electrical Connection

Power requirements are stated on the unit nameplate and must be connected accordingly. This appliance, when installed must be electrically grounded in accordance with local codes, or in the absence of local codes, with the National Electrical Code, ANSI/NFPA 70, or the Canadian Electrical Code, CSA C22.2, as applicable. Before starting broiler, tighten all electrical connections in control box. An electrical wiring diagram can be found inside the control box.

Note: Disconnect power before servicing.

B.10 Pre-Operation Check

Be sure that all parts are installed in the proper location:

- Ventilation is turned on
- Broiler is plugged in
- Gas line is connected

C. OPERATION

C.1 Controls and Indicators

ON THE SIDE



On/Off Indicator Light
Broiler is on when
illuminated

Left Belt Speed
Control - Push
and turn to set
cook times

Right Belt
Speed Control
- Push and
turn to set
cook times

Load Sensing
Control - Use
to calibrate
broiler and set
temperature

Main On/Off
Switch - Push
up to turn on,
down to turn
off

ON DISCHARGE END

Gas Gauge
P/N 16036



CONTROL BOX SIDE

Belt Reverse Buttons - Push to reverse the
belts in case of a jam.



C.2 Lighting Procedures

PRE-LIGHTING PREPARATION

1. Broiler is centered under hood and plugged in
2. Gas line is connected
2. Gas valve is open when handle is in line (parallel to) the pipe
3. Turn ventilation system on

NORMAL IGNITION

The MPB73 is equipped with automatic ignition. When the broiler is turned on, a hot surface ignitor turns on 5 seconds before the flow of gas. Gas then flows to all of the burners. If the burners are not lit within 10 seconds, the control will reset and try again for 10 seconds. This occurs 3 times. If the broiler does not light after the third attempt, the ignition failure light will flash and the main on/off switch must be cycled to repeat the procedure. If this still doesn't light the broiler, see the MANUAL IGNITION instructions.

1. Turn the **MAIN POWER SWITCH** on.



2. Check **GAS PRESSURE GAUGE** reading. Gauge should read 4"*. If the gauge is not easy to see look to make sure that all burners - upper and lower - have lit.



3. Allow broiler to heat for 45 minutes before cooking. During the warm up period, the control will display "Lo" (low). Do not cook during the warm up period.

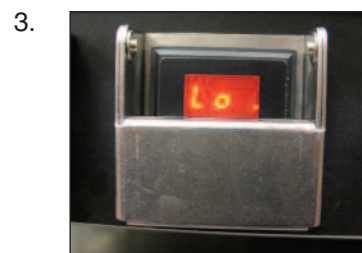

4. Allow broiler to heat for 45 minutes before cooking. After warm-up period, the load sensing control should read "Rdy" (ready).



*For Natural Gas only. For LP broilers: Gas pressure should be 11".

C.2 Lighting Procedures (Continued.)

MANUAL IGNITION

1. Turn the **MAIN POWER SWITCH** on. Hold a lighter/match to the first upper burner on the discharge end until the burner lights. Once the first burner is lit, verify that all burners have ignited.

1.



2. Check **GAS PRESSURE GAUGE** reading. Gauge should read 4"*. If the gauge is not easy to see look to make sure that all burners - upper and lower - have lit.

2.



*For Natural Gas only. For LP broilers gas pressure should be 11".

C.3 Shutdown Procedures

PLANNED SHUTDOWN

1. Allow the broiler to run free of any product for 15 minutes. This will burn the chain clean.

2. Turn off the **MAIN POWER SWITCH**.



3. Wait for 30 minutes for the broiler to cool.

EMERGENCY SHUTDOWN

1. Turn off the **MAIN POWER SWITCH**.



2. Close the **MAIN GAS VALVE (b)** Valve is closed when it is perpendicular to pipe.



Your Nieco Automatic Broiler is designed to automatically stop gas flow to the broiler in the event of power failure, gas pressure loss or any other related incident. No attempt to operate this appliance should be made in the event of a power failure.

⚠ CAUTION ⚠

In a prominent location, post instructions to be followed in the event the user smells gas. This information shall be obtained by consulting your local gas supplier.

⚠ CAUTION ⚠

FOR YOUR SAFETY: Do not store or use gasoline or other flammable vapors or liquids in the vicinity of this or any other appliance.

⚠ CAUTION ⚠

FOR YOUR SAFETY: In the event of a prolonged power failure, no attempt should be made to operate this appliance.

C.4 Control Operation

C.4.1 SETTING BELT SPEEDS

Lift cover, press and turn the belt speed control knob to the desired speed setting. The control displays real time.

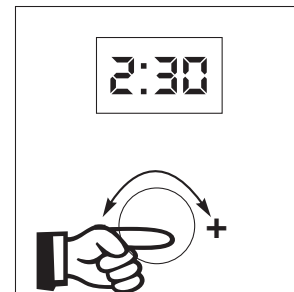

C.4.2 LOAD SENSING CONTROL

How it works:

The MPB73 is equipped with a load sensing control. This control will detect when your broiler is getting too hot and will lower the gas pressure to help cool the broiler down (in the event of a flare up). The control is factory set, and does not require any changes.

Operation:

When the broiler is first turned on, the control will display: Lo (low - see figure A). **If the control is displaying Lo, DO NOT COOK ON THE BROILER.** The load sensing control will display Rdy (ready - see figure B) when the broiler is ready to cook on.

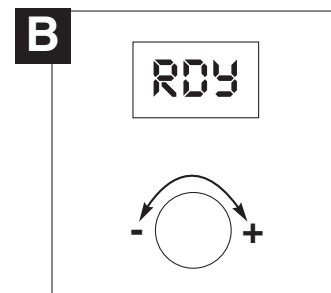
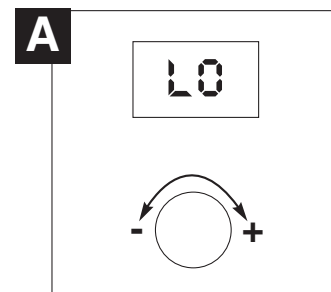

D. CLEANING AND DISASSEMBLY

Turn broiler off and close the main gas valve. Disconnect the power supply to the broiler before cleaning or servicing. If this broiler is connected using a restraint, and disconnection of the restraint is necessary for cleaning or moving the broiler, the restraint must be reconnected after the broiler has been returned to its originally installed position. Allow to cool for 30 minutes prior to cleaning/disassembly. Leave the ventilation system on during cooling. Use only approved cleaning, degreasing and sanitizing solutions.

⚠ WARNING ⚠

LEAVE THE VENTILATION HOOD ON DURING COOLING. FAILURE TO DO SO COULD POSE A FIRE SAFETY HAZARD.

⚠ CAUTION ⚠

Follow the Disassembly and Reassembly steps to ensure proper operation of the broiler. Failure to do so may result in operational problems.

⚠ WARNING ⚠

BROILER PARTS ARE HOT. DO NOT ATTEMPT TO DISASSEMBLE THE BROILER UNTIL IT IS FULLY COOL. FAILURE TO FOLLOW THIS INSTRUCTION MAY RESULT IN SEVERE INJURY.

ALL PARTS ARE CLEANED ON A DAILY BASIS UNLESS OTHERWISE NOTED

Follow the steps for proper disassembly. Reverse the order for reassembly.

How to read the cleaning section

The name of the part to be cleaned. The location of the part. When to clean the part.

The tools needed to clean the part

How to remove and clean the parts.

Picture of the part to be removed and cleaned.

Feeder Housing **Clean: Daily**

Tools

3-Compartment Sink Scrub Pad

Instructions

1. Lift and remove.
2. Wash, rinse, and sanitize in the 3-compartment sink or dishwasher.

REASSEMBLY: Hang feeder housing on brackets.

Feed End

Cleaning the Broiler



Tools Needed

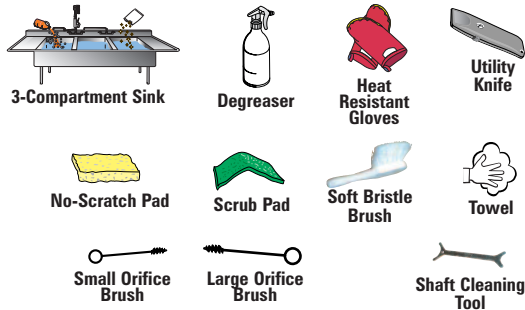

Important Symbols



This "Stop" sign shows a step in the procedure that must be followed exactly or personal safety could be affected.



This warning symbol shows a step in the procedure that must be followed exactly or broiler performance could be affected.



This "puzzle" symbol shows a step in the reassembly procedure that must be followed.



Instructions

1. Allow the broiler to run free of product for 15 minutes before turning it off. This allows any residue to burn off the chains.
2. Shut the broiler off and let it cool for 30 minutes before disassembly and cleaning.
3. Close the main gas valve and unplug the broiler before cleaning.
4. Always leave the ventilation hood on during the 30 minute cool down period.
5. Use only approved cleaning solutions.
6. Allow parts to air dry after cleaning.

NOTE: For clarity, some instructions are shown without using high temperature gloves. Always use gloves when the glove icon is shown.

Wire Belt Feeder Base P/N 17548 (LH) 17541 (RH)

Clean: Every 4 hours / per shift



Tools



Instructions

1. Pull the release pin.
2. Lift push bar and wire belt feeder bases up and off.
3. Wash, rinse, and sanitize in the 3-compartment sink or dishwasher.

REASSEMBLY: Pull the release pin and place feeder base in position.

Feed End



Pull release pin

Feeder Housing - P/N 17517

Clean: Daily



Tools

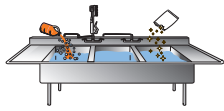

3-Compartment Sink



Scrub Pad



Instructions

1. Lift and remove.
2. Wash, rinse, and sanitize in the 3-compartment sink or dishwasher.



REASSEMBLY: Hang feeder housing on brackets.

Feed End



Grease Pan - P/N 17601

Clean: Daily or as needed



Tools



Heat Resistant Gloves



Scrub Pad



Degreaser

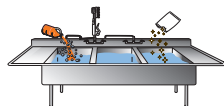

3-Compartment Sink



Instructions

1. Slide grease pan out.
2. Take to sink area and spray with degreaser.
3. Wash with a scrub pad, rinse, and sanitize in the 3-compartment sink.



Make sure grease pan is cool before putting in water or it may warp the pans.

NOTE: Your MPB73 shipped with two (2) grease pans. If necessary, rotate them during the day as needed.

Feed End



Discharge Pan Insert - P/N 17605

Clean: Per Shift



Tools



Degreaser



Green Scrub Pad



Dip Tank - If Applicable

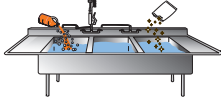

3-Compartment Sink



Instructions

1. Lift pan insert out.
2. Take to sink area and spray with degreaser. or place part in dip tank.
3. Wash with a scrub pad, rinse, and sanitize in the 3-compartment sink.
4. Air dry.

 **Make sure insert is cool before putting in water or it may warp.**

Discharge End



Discharge Pan - P/N 17604

Clean: Daily



Tools



Green Scrub Pad

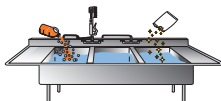

3-Compartment Sink



Degreaser



Instructions

1. Lift discharge pan up and off slots.
2. Take to sink area and spray with degreaser.
3. Wash with a scrub pad, rinse, and sanitize in the 3-compartment sink.
4. Air dry.

 **Pan hooks on slots.**

Discharge End



Stripper Blade - P/N 17598

Clean: Daily



Tools



Heat Resistant Gloves



Scrub Pad



Degreaser

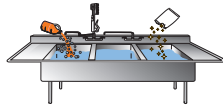

3-Compartment Sink



Instructions

1. Tilt stripper blade away from chain; lift off brackets.

! Make sure stripper blade is cool before putting in water or it may warp.

2. Take to sink area and spray with degreaser.
3. Wash with a scrub pad, rinse, and sanitize in the 3-compartment sink.

+ REASSEMBLY: Hang stripper blade on brackets.

Discharge End

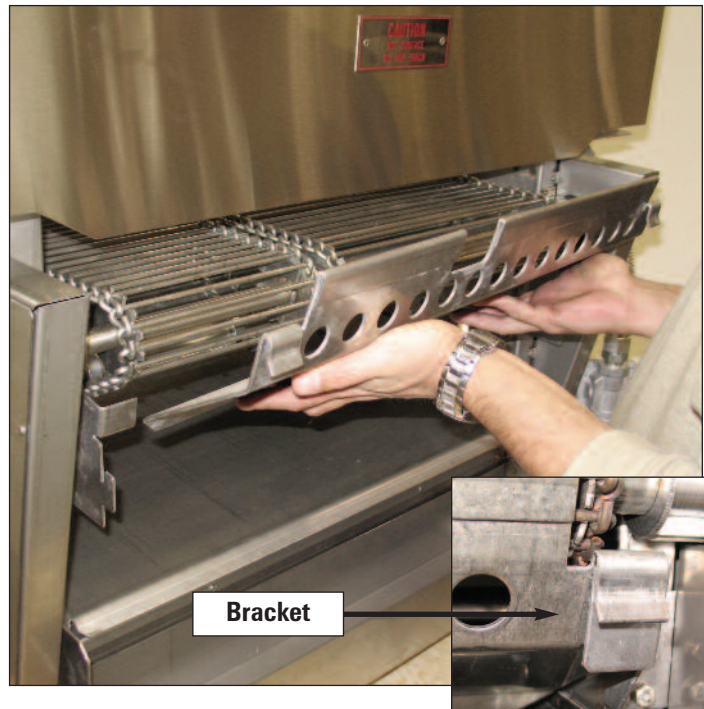

Grease Box - P/N 17110

Clean: Twice daily



Tools



Dishwasher



Green Scrub Pad



Instructions

1. Wipe debris around grease box opening into the grease box before removing.
2. Slide grease box out.
3. Let oil first cool to room temperature, dispose oil in trash, normal automatic dishwasher procedures.
4. Air dry.

Discharge End



Chain Shafts

Clean: Daily



Tools



Shaft Cleaning
Tool



Instructions

1. Scrape each shaft of both belts on the discharge end with the wide end of the shaft cleaning tool that came with your broiler. Wipe shaft cleaning tool with a towel.

⚠ Do not run the broiler while cleaning the shafts. Clean only the part that is accessible.

Discharge End



Side Panels - P/N 17620

Clean: Weekly



Tools



No-Scratch Pad



Instructions

1. Lift and remove side panels.
2. Wipe clean with a no scratch pad.

Side



Lower Burners - P/N 16974 (Double); 17622 (Single)

Clean: Weekly



Tools



Heat Resistant Gloves

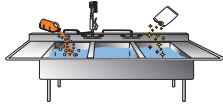

3-Compartment Sink



Scrub Pad



Instructions

1. Open the side access door.
2. Slide burners out.
3. Take to the 3-compartment sink and scrub with a scrub pad.
4. If necessary, use a stiff toothbrush to clean any clogged burner holes.
5. Repeat steps for all burners.

 **REASSEMBLY:** Be sure the holes on the burner are facing up.

 **Burners must be completely dry before reassembly.**

Side



Lower Burner Shields - 16988

Clean: Weekly



Tools



Heat Resistant Gloves

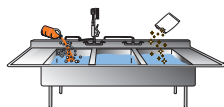

3-Compartment Sink



Scrub Pad



Instructions

1. From the feed end, lift up and pull towards you.
2. Wash with a scrub pad, rinse, and sanitize in the 3-compartment sink.

 **REASSEMBLY:** Make sure shields are seated properly on brackets.

Feed End

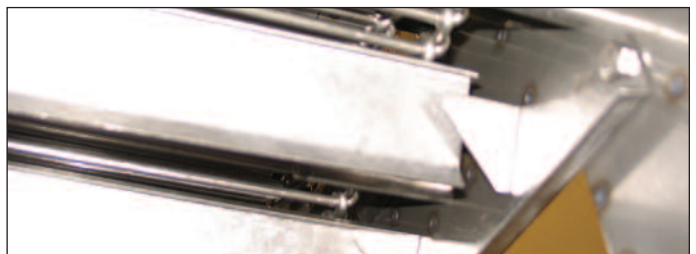

Flame Sensor - P/N 17185

Clean: Weekly



Tools



Scrub Pad



Instructions

1. Polish with a dry scrub pad.



Do NOT use water on the flame sensor.

Feed End

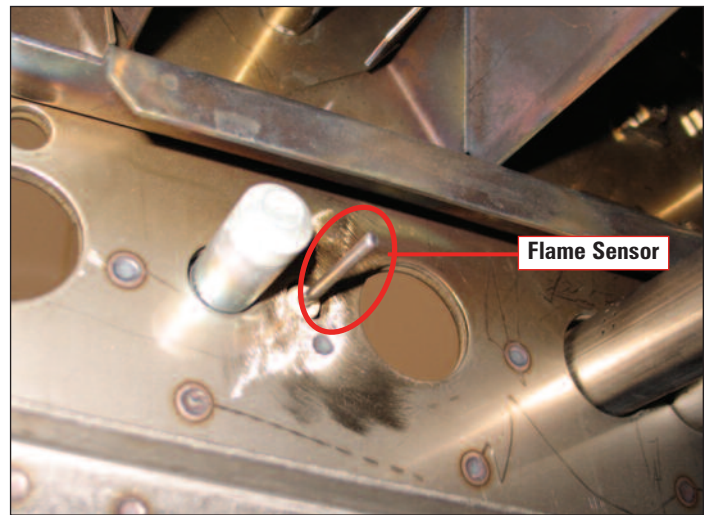

No spray



No water

Catalyst - If no perforated cap - P/N 17441

Clean: Weekly



Tools



Heat Resistant Gloves



Instructions



EXTREMELY HOT! Be careful not to burn yourself.

1. Grasp handle and lift Catalyst off to remove from Shroud.
2. SOAK IN WARM WATER FOR 1 HOUR. RINSE WITH WATER ONLY. NEVER USE ANY CHEMICALS ON THE CATALYST.
3. Lay flat to drain water and let air dry overnight.
4. Make sure catalyst s dry before putting back on broiler.

Top

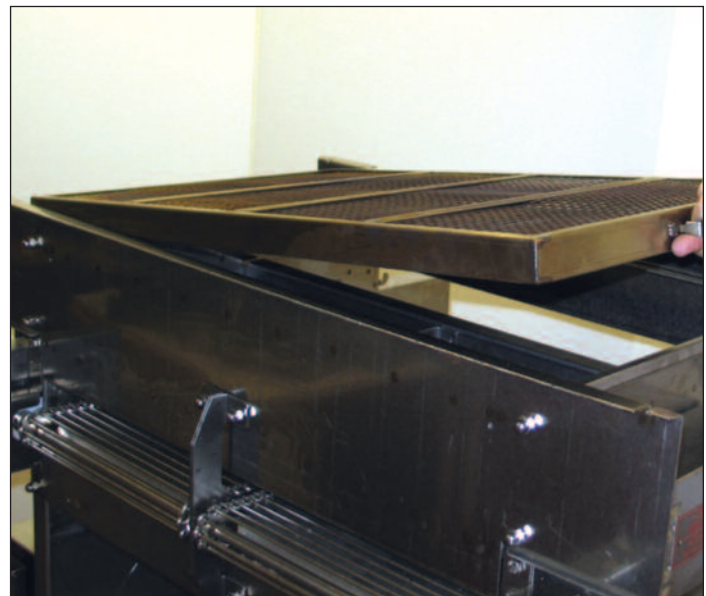

CAUTION:
Extremely Hot 



Tools



Heat Resistant Gloves



Scrub Pad



Degreaser

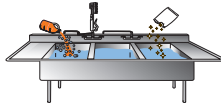

3-Compartment Sink



Instructions



EXTREMELY HOT! Be careful not to burn yourself.

1. Lift cap from shroud collar.
2. Take to sink area and spray with degreaser.
3. Wash with a scrub pad, rinse, and sanitize in the 3-compartment sink.

Top



CAUTION: Extremely Hot



Tools



Heat Resistant Gloves

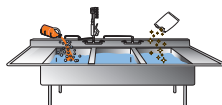

3-Compartment Sink



Scrub Pad



Instructions

1. Lift each burner up and out of broiler.
2. Take to the 3-compartment sink and scrub with a scrub pad.
3. If necessary, use a stiff toothbrush to clean any clogged burner holes.
4. Repeat steps for all burners.

Burners must be completely dry before reassembly.

Top





Tools



Small Orifice Brush



Instructions

1. Clean orifices using a small, dry orifice brush.

Inside

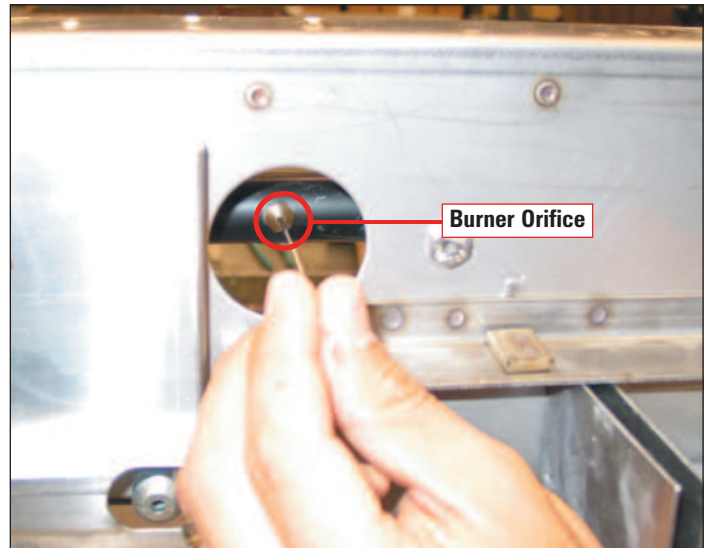

E. TROUBLESHOOTING

Always verify that the broiler is properly assembled, the hood is on, gas valve open and broiler is plugged in.

Problem:

Possible Solution:

No power to broiler when the switch is turned on.	Check: Broiler is plugged in. Circuit Breaker on wall panel is on.
Broiler has power, but the burners do not light.	Check: Ventilation hood is on. Gas line is properly plugged in. Manual gas valve (if equipped) is on. Burners are installed properly. Burners are clean and dry. Flame sensor wire connection. Follow manual lighting instructions.
Red light blinking on left control box.	Check the items above for burners not lighting. Turn power off and on again to reset ignition. Follow manual lighting instructions.
Hot surface ignitor does not heat.	Check for loose wires connecting the hot surface ignitor. Follow manual lighting instructions.
Power is on, broiler is lit, but the conveyor belts are not turning.	Check for a jam in the conveyor belt. Use the belt reverse buttons located on the side of the control box to help clear a belt jam. Check the stripper blade to make sure it is installed properly.
Feeder belt not moving.	Make sure the feeder is assembled properly. Check for jam. Make sure the drive pin is engaged.
Burgers sticking to slide or stripper blade.	Clean the slide and stripper blade very thoroughly. Check cookout temperature (undercooking).
Burgers under or over cooked.	Adjust conveyor belt speed. Clean burners and orifices.
Excessive flaming in broiler.	Clean the catalyst if equipped. Check the hood for proper operation. Check product for overcooking.

Recommended Maintenance

Replace the following parts according to this schedule or as needed:

Yearly	Replace: P/N 2185 Zip Tube Orifice P/N 2182 Pilot Orifice
Every 6 Months	Replace: P/N 17185 Flame Sensor

F. PARTS LOCATION DRAWINGS

Feed End View

- 1 - 17491 - INSERT, PERFORATED
- 2 - 17441 - INCENDALYST
- 3 - 18084 - REFLECTOR, HEAT
- 4 - 17403 - BURNER W/REFLECTOR
- 5 - 17620 - PANEL, SIDE
- 6 - 17548 - DRIVE UNIT, WIRE BELT, 14" BELT, LH
- 7 - 17541 - DRIVE UNIT, WIRE BELT, 8" BELT, RH
- 8 - 17601 - GREASE PAN, FRONT
- 9 - 17517 - ENCLOSURE, FEEDER, 14" & 8" BELT

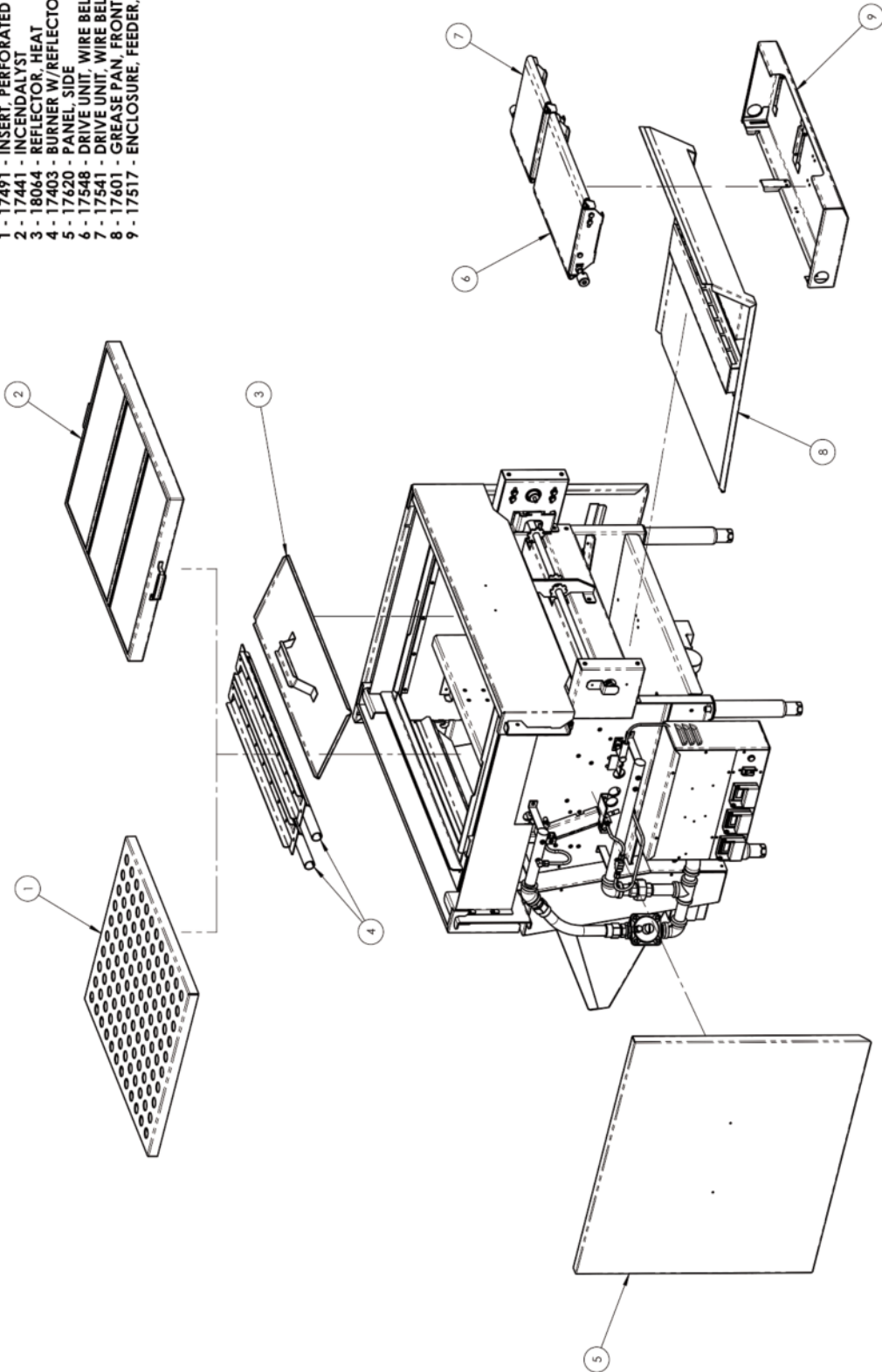

Discharge End View

- 1 - 17720 - HEAT SHIELD, FRONT/REAR
- 2 - 17620 - PANEL, SIDE
- 3 - 16558 - DOOR, HINGED
- 4 - 16988 - SHIELD, LOWER BURNER
- 5 - 16974 - BURNER, DOUBLE FULL
- 6 - 17622 - STRIPPER BLADE, 14" & 8" BELT
- 7 - 17598 - INSERT, DRAIN/CATCH PAN
- 8 - 17605 - DRAIN/CATCH PAN
- 9 - 17604 - PAN, GREASE, DRIP, FLOW THRU
- 10 - 17110 - PAN, GREASE, DRIP, FLOW THRU

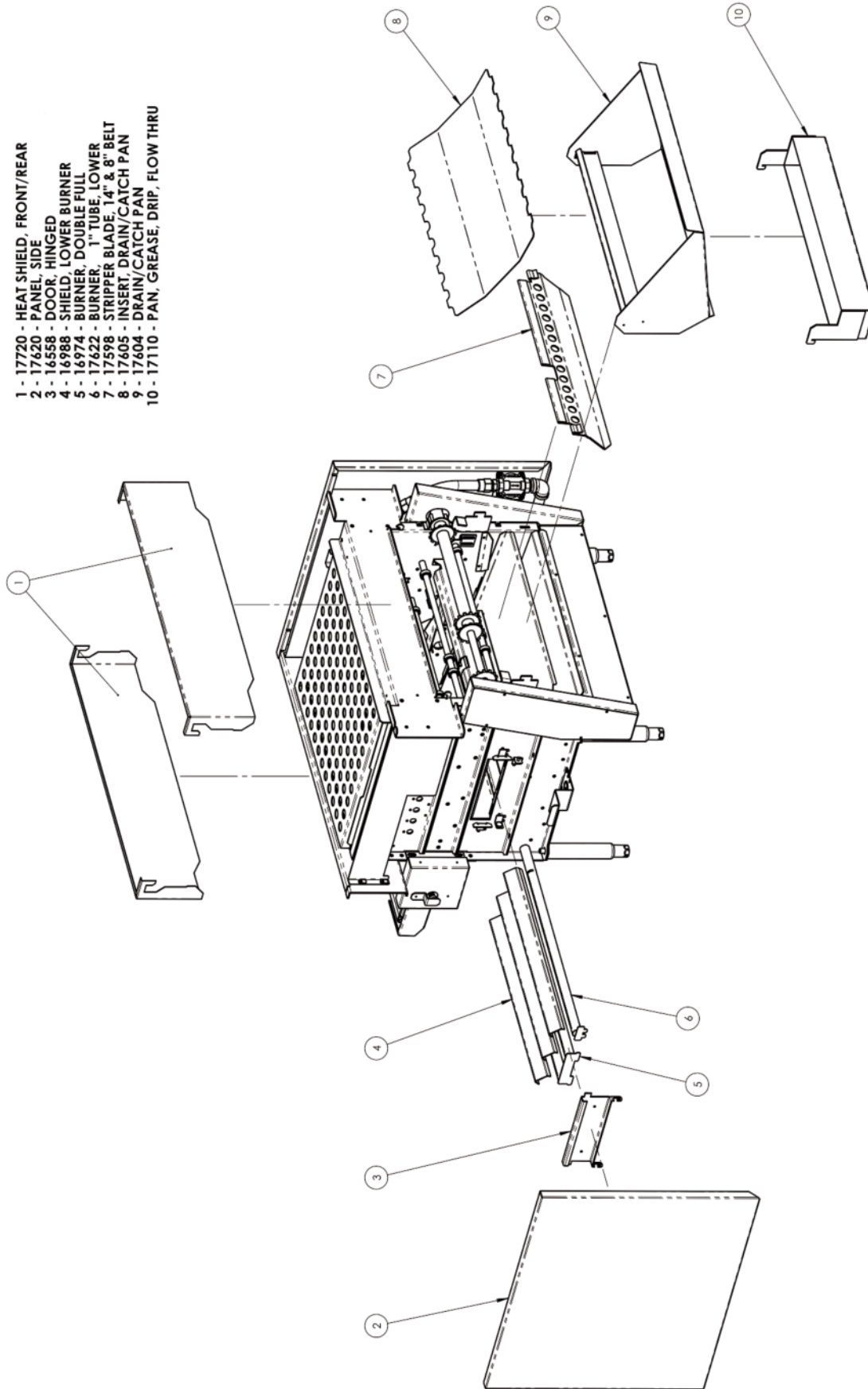

G. SPECIFICATIONS

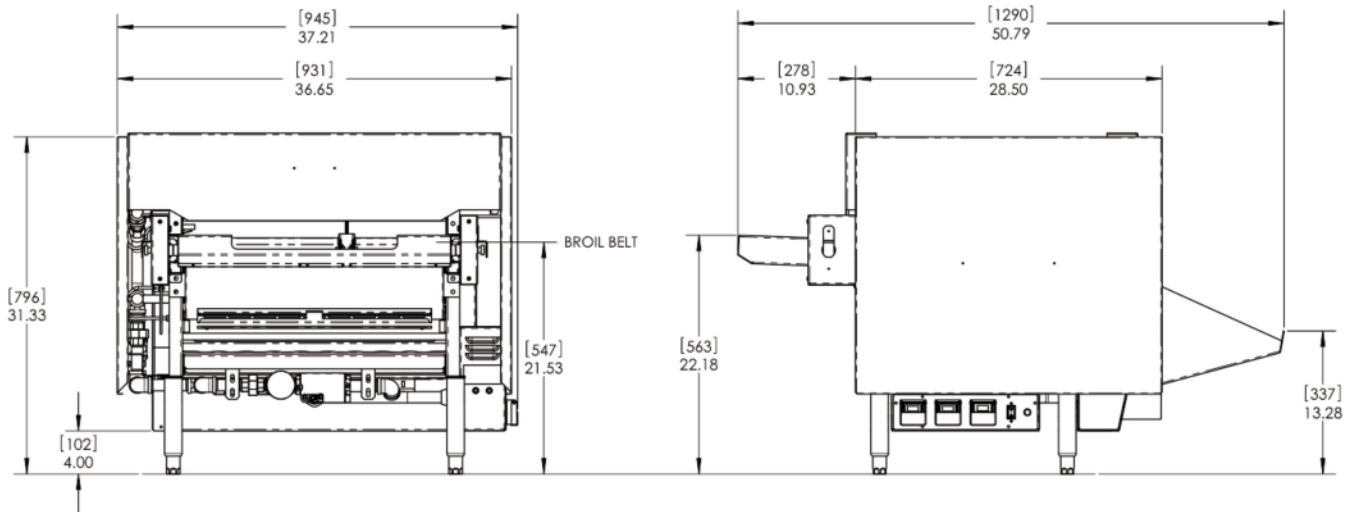

AUTOMATIC BROILER

Model MPB73

DIMENSIONS	INCH	MM
Length	28.50	724
Height	31.33	796
Width	37.21	945

ENERGY - GAS MODELS

Gas connection 3/4" N.P.T.

Electrical connection (specify exact voltage)

Domestic 115V IØ 2A 60hz

Natural Gas #41 Orifices	2.5" W.C.	4" W.C.
BTU/hr	80,900	91,200

EXHAUST	CFM	CMH
Typical	700	1189

WEIGHT	LBS	KG
Shipping	600	273
Broiler	525	239

⚠ CAUTION ⚠

All electrical connections must be in accordance with local electrical codes and any other applicable codes.

⚠ CAUTION ⚠

Do not operate the broiler at gas pressures other than those stated here. Doing so will affect the operation of your broiler.



Nieco Corporation

7950 Cameron Drive

Windsor, CA 95492

(707) 284-7100 Office • (707) 284-7430 Fax

www.nieco.com • e-mail: service@nieco.com

Printed in the USA © 2007 Nieco Corporation