

REPLACEMENT PARTS LIST

**RESIDENTIAL SPLIT SYSTEM HEAT PUMP
ESH1BF4M(1,2)S SERIES
16 SEER MODELS**

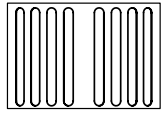

Corner Post Style



Panel Style

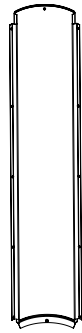
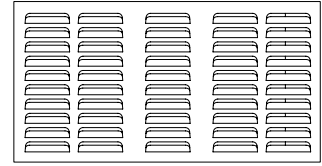

Corner Post

Outdoor Fan Grille

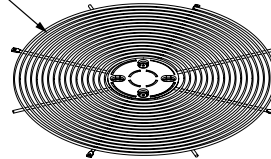

Outdoor Fan Motor

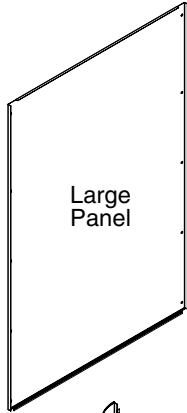
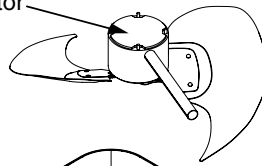

Large Panel

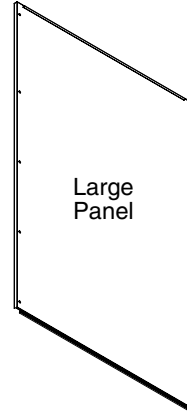

Large Panel

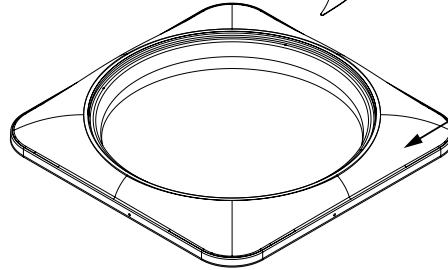

Top Pan

Corner Post



Corner Post

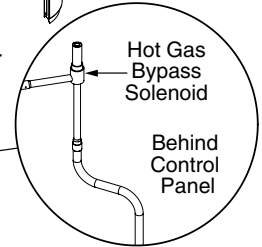
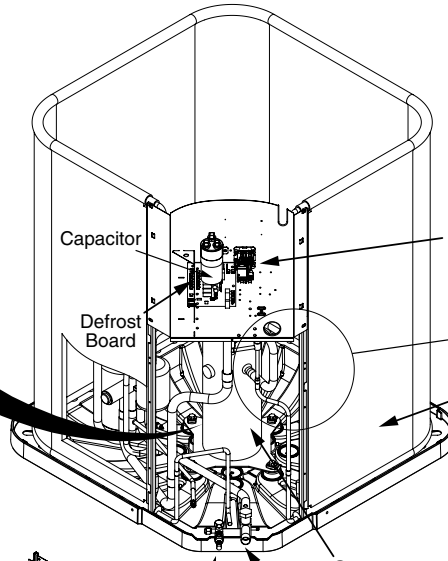
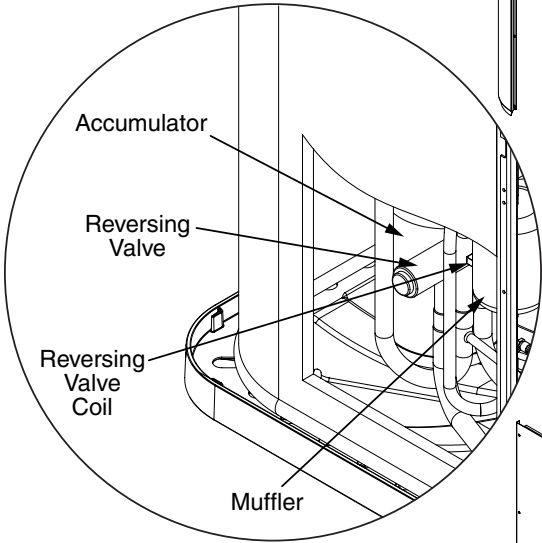

Hot Gas Bypass Solenoid

Behind Control Panel

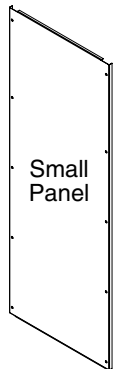

Small Panel



Left Back Post

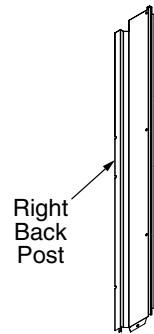

Right Back Post

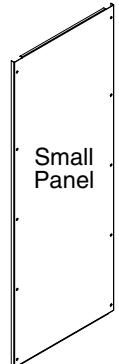

Small Panel

ESH1BF4M(1,2)S RESIDENTIAL SPLIT SYSTEM HEAT PUMP

DESCRIPTION	ESH1BF4M1SP24K	ESH1BF4M1SP30K	ESH1BF4M1SP36K	ESH1BF4M1SP42K	ESH1BF4M1SP48K	ESH1BF4M2SX60K
	1014225E	1014226E	1014227E	1014228E	1014229E	1014238E
ACCUMULATOR	668853R	668853R	668794R	668854R	668854R	668854R
AMBIENT SENSOR	624780R	624780R	624780R	624780R	624780R	624780R
CAPACITOR	01-0083	01-0084	01-0085	01-0273	01-0271	01-0097
COMPRESSOR	921422	921424	921426	1017098R	922459	921793
COMPRESSOR MOLDED PLUG	634660R	634660R	634660R	634660R	634660R	634660R
COMPRESSOR PLUG, LV 2 STAGE	—	—	—	—	—	634682R
CONTACTOR	1014863R	1014863R	1014863R	1014864R	1014864R	1014865R
CORNER POST	101472204R	101472204R	101472206R	101472206R	101472206R	101472206R
CRANKCASE HEATER	632410R	632410R	632410R	632410R	632410R	632410R
DEFROST BOARD	1016567R	1016567R	1016567R	1016567R	1016567R	1016567R
DEFROST SENSOR	624812R	624812R	624812R	624812R	624812R	624812R
FILTER DRIER	669762R	669762R	669762R	669761R	669761R	669761R
HIGH PRESSURE SWITCH	632473R	632473R	632473R	632473R	632473R	632473R
HOT GAS BYPASS COIL	669992R	669992R	669992R	669992R	669992R	669992R
HOT GAS BYPASS VALVE	669964R	669964R	669965R	669965R	669965R	669965R
LOW PRESSURE SWITCH	—	—	—	—	—	632393R
LARGE PANELS	101074204R	101074204R	101074206R	101074206R	101074206R	101074206R
LEFT BACK POST	101450404R	101450404R	101450406R	101450406R	101450406R	101450406R
MUFFLER	669546R	669546R	669546R	669546R	669546R	669546R
OUTDOOR COIL	664832R	664832R	664907R	664909R	664909R	664909R
OUTDOOR FAN BLADE	667351R	667351R	667351R	667351R	667351R	667319R
OUTDOOR FAN GRILLE	669591R	669591R	669591R	669591R	669591R	669591R
OUTDOOR FAN MOTOR	622171	622171	1006724	1006724	1006724	1006724
REFRIGERANT VALVE (LG)	663864R	663864R	663865R	663865R	663865R	663865R
REFRIGERANT VALVE (SM)	664850R	664850R	664850R	664850R	664850R	664850R
REVERSING VALVE	669465R	669465R	M0079102	M0079102	M0079102	M0079102
REVERSING VALVE COIL	669470R	669470R	669937R	669937R	669937R	669937R
RIGHT BACK POST	101450304R	101450304R	—	—	—	—
SMALL PANELS	—	—	101074406R	101074406R	101074406R	101074406R
SWIVEL NUT CONNECTOR	664194R	664194R	664194R	664194R	664194R	664194R
THERMOSTATIC EXPANSION VALVE	—	—	—	—	—	669578R
TOP PAN	101609001R	101609001R	101609001R	101609001R	101609001R	101609001R

Please specify the correct Model No., Serial No., and part number(s) when ordering parts from the nearest authorized dealer or service center.

