



## ***Blast Chillers***

*Models BC-IT-0103, 0905, 0906, 0910*

*Items 41899, 45262, 41317, 45263*

## ***Instruction Manual***



*Revised - 02/15/2018*



Toll Free: 1-800-465-0234  
Fax: 905-607-0234  
Email: [service@omcan.com](mailto:service@omcan.com)  
[www.omcan.com](http://www.omcan.com)



# ***Table of Contents***

Model BC-IT-0103 / Model BC-IT-0905 / Model BC-IT-0906 / Model BC-IT-0910

---

<b>Section</b>	<b>Page</b>
General Information -----	3 - 4
Safety and Warranty -----	4 - 5
Technical Specifications -----	6
Installation -----	6 - 7
Operation -----	7 - 11
Maintenance -----	11 - 13
Parts Breakdown -----	14 - 19
Electrical Schematics -----	20
Notes -----	21 - 22
Warranty Registration -----	23



# General Information

---

Omcan Manufacturing and Distributing Company Inc., Food Machinery of America, Inc. dba Omcan and Omcan Inc. are not responsible for any harm or injury caused due to any person's improper or negligent use of this equipment. The product shall only be operated by someone over the age of 18, of sound mind, and not under the influence of any drugs or alcohol, who has been trained in the correct operation of this machine, and is wearing authorized, proper safety clothing. Any modification to the machine voids any warranty, and may cause harm to individuals using the machine or in the vicinity of the machine while in operation.

## CHECK PACKAGE UPON ARRIVAL

Upon receipt of an Omcan shipment please inspect for external damage. If no damage is evident on the external packaging, open carton to ensure all ordered items are within the box, and there is no concealed damage to the machine. If the package has suffered rough handling, bumps or damage (visible or concealed), please note it on the bill of lading before accepting the delivery and contact Omcan within 24 hours, so we may initiate a claim with the carrier. A detailed report on the extent of the damage caused to the machine must be filled out within three days, from the delivery date shown in the shipping documents. Omcan has no recourse for damaged products that were shipped collect or third party.

**Before operating any equipment, always read and familiarize yourself with all operation and safety instructions.**

Omcan would like to thank you for purchasing this machine. It's of the utmost importance to save these instructions for future reference. Also save the original box and packaging for shipping the equipment if servicing or returning of the machine is required.

---

Omcan Fabrication et distribution Compañie Limité et Food Machinery d'Amérique, dba Omcan et Omcan Inc. ne sont pas responsables de tout dommage ou blessure causé du fait que toute personne ait utilisé cet équipement de façon irrégulière. Le produit ne doit être exploité que par quelqu'un de plus de 18 ans, saine d'esprit, et pas sous l'influence d'une drogue ou d'alcool, qui a été formé pour utiliser cette machine correctement, et est vêtu de vêtements de sécurité approprié. Toute modification de la machine annule toute garantie, et peut causer un préjudice à des personnes utilisant la machine ou des personnes à proximité de la machine pendant son fonctionnement.

## VÉRIFIEZ LE COLIS DÈS RÉCEPTION

Dès réception d'une expédition d'Omcan veuillez inspecter pour dommages externes. Si aucun dommage n'est visible sur l'emballage externe, ouvrez le carton afin de s'assurer que tous les éléments commandés sont dans la boîte, et il n'y a aucun dommage dissimulé à la machine. Si le colis n'a subi aucune mauvaises manipulations, de bosses ou de dommages (visible ou cachée), notez-le sur le bond de livraison avant d'accepter la livraison et contactez Omcan dans les 24 heures qui suivent, pour que nous puissions engager une réclamation auprès du transporteur. Un rapport détaillé sur l'étendue des dommages causés à la machine doit être rempli dans un délai de trois jours, à compter de la date de livraison indiquée dans les documents d'expédition. Omcan n'a aucun droit de recours pour les produits endommagés qui ont été expédiés ou cueilli par un tiers transporteur.

# ***General Information***

---

**Avant d'utiliser n'importe quel équipement, toujours lire et vous familiariser avec toutes les opérations et les consignes de sécurité.**

**Omcan voudrais vous remercier d'avoir choisi cette machine. Il est primordial de conserver ces instructions pour une référence ultérieure. Également conservez la boîte originale et l'emballage pour l'expédition de l'équipement si l'entretien ou le retour de la machine est nécessaire.**

---

**Omcan Empresa De Fabricacion Y Distribucion Inc. Y Maquinaria De Alimentos De America, Inc. dba Omcan y Omcan Inc. no son responsables de ningun daño o perjuicio causado por cualquier persona inadecuada o el uso descuidado de este equipo. El producto solo podra ser operado por una persona mayor de 18 años, en su sano juicio y no bajo alguna influencia de droga o alcohol, y que este ha sido entrenado en el correcto funcionamiento de esta máquina, y ésta usando ropa apropiada y autorizada. Cualquier modificación a la máquina anula la garantía y puede causar daños a las personas usando la máquina mientras esta en el funcionamiento.**

## **REVISE EL PAQUETE A SU LLEGADA**

Tras la recepcion de un envio Omcan favor inspeccionar daños externos. Si no hay daños evidentes en el empaque exterior, Habra el carton para asegurarse que todos los articulos solicitados estén dentro de la caja y no encuentre daños ocultos en la máquina. Si el paquete ha sufrido un manejo de poco cuidado, golpes o daños (visible o oculto) por favor anote en la factura antes de aceptar la entrega y contacte Omcan dentro de las 24 horas, de modo que podamos iniciar una reclamación con la compañía. Un informe detallado sobre los daños causados a la máquina debe ser llenado en el plazo de tres días, desde la fecha de entrega que se muestra en los documentos de envío. Omcan no tiene ningun recurso por productos dañados que se enviaron a recoger por terceros.

**Antes de utilizar cualquier equipo, siempre lea y familiarizarse con todas las instrucciones de funcionamiento y seguridad.**

**Omcan le gustaría darle las gracias por la compra de esta máquina. Es de la mayor importancia para salvar estas instrucciones para futuras consultas. Además, guarda la caja original y el embalaje para el envío del equipo si servicio técnico o devolución de la máquina que se requiere.**

# ***Safety and Warranty***

---

## **GENERAL WARNINGS**

This manual has been prepared to enable the correct installation, regulation and maintenance of the unit. It is therefore of basic importance that the warnings contained in this booklet are carefully read as they supply essential indications regarding the safety of the installation, use and maintenance. This manual and the wiring diagram must be stored with care and made available to the operator for any future consultation. The appliance must be installed, tested and serviced by qualified personnel only. Any adjustment whatsoever not

# *Safety and Warranty*

---

expressly authorized and in disrespect of this manual voids the warranty. Observe all existing local regulations at the time of installation. Check that the characteristics of the electric grid correspond to the data given on the serial plate of the appliance. The packing materials (plastic bags, polystyrene, nails, etc.) as potential hazards, must be kept out of the reach of children and properly recycled according to the existing local regulations. The unit has been designed and constructed for the blast chilling and freezing of foodstuffs and should therefore be destined to this sole purpose for which it has been expressly conceived. Shutdown the appliance in the event of a malfunction. For repairs contact Omcan and request the use of original spare parts. If in doubt do not use the appliance and contact Omcan. Not following the above conditions could risk the safety of those using the unit.

## **TECHNICAL WARNINGS**

The appliance must be used by qualified personnel. Keep away from children at all times especially if it is in operation. Every unit has a serial plate on the right side.

## **OPERATIONAL WARNINGS**

Remove any non-necessary material such as the manual, plastic bags, polystyrene, nails, etc before beginning operation. Clean the inner and outer surfaces only with warm water and soap or a neutral detergent. Rinse with water and dry thoroughly. Do not use abrasive brushes or other damaging materials for the unit's surfaces. At the end of the working day, thoroughly clean the inside and outside of the machine, to ensure the smooth operation of the appliance and to prolong its life. Do not use high pressure water jets when cleaning the appliance. Never stretch the power cable. Place the machine in a well ventilated room. When using the appliance, never obstruct the air inlet, this can compromise its performance and safety. For the final disposal of this appliance, comply with local regulations.

## **1 YEAR PARTS AND LABOUR WARRANTY**

**Within the warranty period, contact Omcan Inc. at 1-800-465-0234 to schedule an Omcan authorized service technician to repair the equipment locally.**

**Unauthorized maintenance will void the warranty. Warranty covers electrical and part failures not improper use.**

**Please see [www.omcan.com/warranty.html](http://www.omcan.com/warranty.html) for complete info.**

### **WARNING:**

The packaging components are classified as normal solid urban waste and can therefore be disposed of without difficulty.

**In any case, for suitable recycling, we suggest disposing of the products separately (differentiated waste) according to the current norms.**

**DO NOT DISCARD ANY PACKAGING MATERIALS IN THE ENVIRONMENT!**

# Technical Specifications

Model	BC-IT-0103	BC-IT-0905	BC-IT-0906	BC-IT-0910
Interior Dimensions	14" x 21.7" x 11" 356 x 550 x 280mm	27.6" x 17.7" x 15" 700 x 450 x 380mm	27.6" x 18.5" x 19.3" 700 x 470 x 490mm	27.6" x 18.5" x 30.3" 700 x 470 x 770mm
Number of Trays	3	5	6	10
Cooling Capacity	12 kgs. / 3°C 8 kgs. / -18 °C	14 kgs. / 3°C 9 kgs. / -18°C	18 kgs. / 3°C 12 kgs. / -18°C	28 kgs. / 3°C 18 kgs. / -18°C
Power	0.63 kW / 0.8 HP	0.79 kW / 1.1 HP	1.19 kW / 1.6 HP	1.56 kW / 2.1 HP
Electrical	220V / 60Hz / 1Ph			
Amps	4.1 A	4.7 A	5.5 A	6.5 A
Refrigerant	R404A			
Gross Weight	165.4 lbs. / 75 kgs.	242.5 lbs. / 110 kgs.	319.7 lbs. / 145 kgs.	374.8 lbs. / 170 kgs.
Dimensions	24.4" x 25.6" x 26.4" 620 x 650 x 670mm	32" x 31" x 31.5" 820 x 785 x 800mm	32.3" x 32.5" x 55.5" 820 x 826 x 1410mm	32.3" x 32.5" x 66" 820 x 825 x 1680mm
Item Number	41899	45262	41317	45263

## Installation

The unit is shipped in appropriate protective packaging. On arrival, check that the unit has not incurred any damages during transportation and that everything is included. In the event of visible damage immediately note the damage on the transport documents. ALL THE OPERATIONS INDICATED BELOW MUST BE PERFORMED IN RESPECT OF THE EXISTING SAFETY REGULATIONS, BOTH FOR THE EQUIPMENT IN USE AND FOR THE OPERATING PROCEDURES.

### HANDLING AND PLACING

BEFORE BEGINNING THE HANDLING OPERATIONS PLEASE ENSURE THAT THE LIFTING CAPACITY OF THE LIFTING DEVICE IS ENOUGH TO SUPPORT THE UNIT.

Insert the forks into the side or back of the wooden pallet supplied with the unit; begin lifting checking that the appliance is stable.

Attention: when inserting the lifting device, pay attention to the location of the power supply cable and the position of the feet. DURING HANDLING DO NOT TIP OR TURN OVER. FOLLOWING THE RECOMMENDATIONS PRINTED ON THE OUTSIDE OF THE PACKAGING GUARANTEES THE PERFECT WORKING CONDITION OF THE UNIT. THEREFORE THE FOLLOWING IS RECOMMENDED: HANDLE WITH CARE, KEEP DRY, STACKING OF OTHER OBJECTS ON THE UNIT IS TO BE AVOIDED, STACKING OF BLAST CHILLERS IS PERMITTED: READ CAREFULLY OF THE MAXIMUM NUMBER OF PIECES INDICATED ON THE PACKAGING. Lift the appliance to separate it from the pallet. Remove the packaging

# Installation

and the protective film; avoid using abrasive brushes or other damaging materials for the appliance's surfaces. Ensure that the appliance is perfectly leveled. Regulate the adjustable feet if necessary. Keep the appliance away from heat sources and in a well ventilated room. When using the appliance, never obstruct the air inlet when the appliance in operation, to do so will compromise its performance and safety.

# Operation





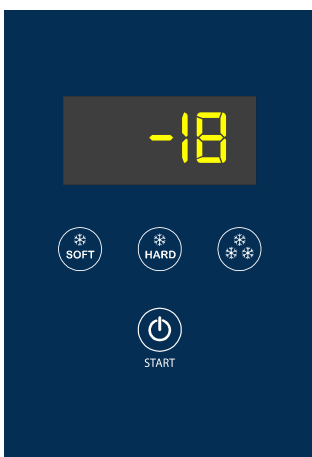

## START-UP

BEFORE CONNECTING THE APPLIANCE CHECK THAT THE DATA ON THE RATING PLATE CORRESPONDS TO THE ACTUAL ELECTRICAL SUPPLY. THE INSTALLATION MUST BE MADE ACCORDING TO THE INSTRUCTIONS GIVEN IN THIS MANUAL, BY PROFESSIONALLY QUALIFIED PERSONNEL. THE ELECTRICAL SAFETY OF THIS APPLIANCE IS GUARANTEED ONLY WHEN IT IS CONNECTED TO AN EFFICIENT GROUNDED SOCKET. OMCAN IS NOT RESPONSIBLE FOR DAMAGES CAUSED BY NOT USING A EFFICIENT GROUNDED SOCKET.

Check that the appliance is perfectly leveled. Adjust the feet if necessary.  
 Check that the plastic protective coating is removed from all external surfaces.  
 Check that the interior is cleaned with warm water and a neutral soap.  
 Check that the appliance is positioned as far as possible from heat sources.  
 Check that the air circulation around the motor compartment is not obstructed.

## CONTROL PANEL AND LEGEND



-  On / Off
-  Freezing
-  Hard Cycle
-  Soft Cycle
-  +  Manual Defrost

## USE AND FUNCTIONS

### STANDBY KEY

With the controller Off: pressing once places the controller in standby.  
 With controller in standby and the cycle selected: pressing once starts the cycle.

# Operation







With controller running the cycle: pressing once stops the cycle.

NOTE: In any condition the controller may be in, holding down for three seconds switches the controller off.

CHILLING KEY: With the controller in standby: pressing once selects a chilling cycle.

HARD KEY: With the controller in standby: pressing once selects a hard cycle.

FREEZING KEY: With the controller in standby: pressing once selects a freezing cycle.

SYMBOL	DESCRIPTION	MEANING
	FREEZING	It flashes during a freezing cycle, and is on during subsequent conservation.
	CHILLING	It flashes during a chilling cycle, and is on during subsequent conservation.
	CONSERVATION	It is on or flashing during a conservation cycle.
	TEMPERATURE	It is on during a temperature cycle.
	TIME	It is on during a cycle with the shaft not inserted.
	OFF	This is on when the controller is off.
°F	FAHRENHEIT	If a temperature is displayed and the unit of measure is degrees Fahrenheit.
°C	CELSIUS	If a temperature is displayed and the unit of measure is degrees Celsius.

## DISPLAY

The four digits of the display may be lit either red or green.

The controller ensures cycles with temperature control at the core of the product. Each cycle is followed by conservation. A manual and/or automatic defrosting cycle is also available.

## CHANGING VALUES OF THE PARAMETERS

To enter the programming menu you must do the following:

- Put the card in "Off" mode and push for 3 seconds the HARD key.
- On display will be visualized in red the label "PASS".
- You have to push the key "HARD".
- On display will be visualized in green the value "0" (zero).
- With the SOFT key (to decrease) and the FREEZING key (to increase) You have to modify the value and write the password correct value: -19 (for this example the correct value is -19).
- Press the HARD key to confirm: if the value is correct, on display will be visualized in red the label of the first available parameter.
- To modify the value of the chosen parameter push the key HARD, on display will be visualized the current value of the chosen parameter.
- Press the HARD key to confirm the new parameter's value and back to the parameter's list.
- In order to EXIT press STANDBY key or wait 20 sec. of time out.

## SELECTING THE TEMPERATURE'S UNIT OF MEASUREMENT

See the above method of changing the parameters. The codes for changing the unit of measurement is P0. You must change the value of P0 from:

1 - Fahrenheit.

0 - Celsius.

## POWER SUPPLY

When the controller is powered up, it runs a two-second lamp test, after which it returns to the status it was in prior to being powered off. Possible statuses include OFF, STANDBY and RUN CYCLE.

### OFF

In the off status, the display and the icons are all off except for the OFF icon, which indicates that power is being provided to the controller. All outputs are disabled. The following keys are enabled in the off status:

- The STANDBY key: to put the controller in standby status.
- The CHILLING and FREEZING keys: by pressing and holding for three seconds, to enable access to firmware identification.

### STANDBY

In the standby status, the display shows the temperature of the cell probe. The OFF icon switches off. The following keys are enabled in standby status:

- The CHILLING key: to select a chilling cycle.
- The FREEZING key: to select a freezing cycle.
- The HARD key: to select a hard chilling cycle.
- The CHILLING and FREEZING keys: held down for three seconds, to start a ventilation defrost cycle.
- The STANDBY key: to start running the selected cycle.

### SELECTION OF A CHILLING CYCLE

With the controller in the standby status, press the CHILLING key. The TEMPERATURE icon and the CHILLING icon will flash. The display shows the temperature of the cell probe. Press the STANDBY key to start running the cycle.

### SELECTION OF A FREEZING CYCLE

With the controller in the standby status, press the FREEZING key. The TEMPERATURE icon and the FREEZING icon will flash. The display shows the temperature of the cell. Press the STANDBY key to start running the cycle.

### SELECTION OF A HARD CHILLING CYCLE

With the controller in the standby status, press the hard key. The TEMPERATURE, CHILLING and FREEZING icons will flash. The display shows the temperature of the cell probe. Press the STANDBY key to start running the cycle.

### RUNNING A CHILLING CYCLE

After selecting a chilling cycle, press the STANDBY key to run it. The CHILLING key will flash. The TEMPERATURE icon is steadily on, whereas the CONSERVATION and TIME icons are off. The display shows the temperature of the product probe. During the chilling phase, you can view the cell probe temperature at any time. Press either the CHILLING, HARD or FREEZING keys to show the cell probe temperature for five seconds. By holding any of the three keys down for three seconds, the duration of chilling will be shown for five seconds. During the cycle, thermostat control is set in the standard point of -12°C/10.4°F. The chilling cycle ends when the temperature of the core probe reaches 3°C/37.4°F. Conservation can now begin. The CHILLING icon stays steadily on, whereas the CONSERVATION icon flashes and the buzzer, if included, sounds intermittently for 10 seconds. Press any key to silence the buzzer and the CONSERVATION icon

# Operation

---

will stay steadily on. The display shows the temperature of the cell probe. During conservation, the set point is 3°C/37.4°F. The maximum admissible temperature which can be reached by the product probe of the set point can only be established in 90 minutes. If these times are exceeded when switching over to conservation, the display shows the cell probe temperature, while the TIME icon flashes to indicate that the time has been exceeded. In conservation mode, if you press and hold the CHILLING, HARD or FREEZING keys for three seconds, you will be shown the total amount of time used during the chilling phase. At any time, you can press the STANDBY key to stop running the cycle. The cycle will remain selected. If you press the STANDBY key again the cycle starts from the beginning. To de-select the cycle, you only need to select another cycle, or press any key from among CHILLING, FREEZING or HARD. This will de-select everything.

## **RUNNING A FREEZING CYCLE**

After selecting a freezing cycle, press the STANDBY key to start it. The FREEZING key will flash. The TEMPERATURE icon is now steadily on, whereas the CONSERVATION and TIME icons are off. The display shows the temperature of the product probe. During the freezing phase, you can always display the temperature of the cell probe for five seconds by pressing either the CHILLING, HARD or FREEZING keys. If you hold down any of these three keys, the duration of chilling will be shown for five seconds. During the cycle, thermostat control is set in the standard point of 36°C/96.8°F. The freezing cycle ends when the temperature of the core probe reaches the set point of -18°C/-0.4°F. Conservation can now begin. The FREEZING icon comes on steadily, whereas the CONSERVATION icon flashes and the buzzer, if included, sounds intermittently for 10 seconds. Press any key to silence the buzzer and the CONSERVATION icon will stay steadily on. The display shows the temperature of the cell probe. During conservation, the set point is -18°C/-0.4°F. The maximum admissible time which can be reached by the product probe of the set point can only be established in 240 minutes. If these times are exceeded when switching over to conservation, the display shows the cell probe temperature, while the TIME icon flashes to indicate that the time has been exceeded. In conservation mode, if you press and hold the CHILLING, HARD or FREEZING keys for three seconds, you will be shown the total amount of time used during the freezing phase. At any time, you can press the STANDBY key to stop running the cycle. The cycle remains selected. If you press the STANDBY key again the cycle starts from the beginning. To de-select the cycle, you only need to select another cycle, or press any key from among CHILLING, FREEZING or HARD. This will de-select everything.

## **RUNNING A HARD CYCLE**

After selecting a hard chilling cycle, press the STANDBY key to run it. The CHILLING and the FREEZING icons will flash. The TEMPERATURE icon is now steadily on, whereas the CONSERVATION and TIME icons are off. The display shows the temperature of the product probe. During the hard phase, you can always display the temperature of the cell probe for five seconds by pressing either the CHILLING, HARD or FREEZING keys. If you hold down any of these three keys, the duration of chilling will be shown for five seconds. A hard cycle is composed of two phases. The first phase includes a very low set point for adjustment of the cell probe of -36°C/-32.8°F, in order to maximize lowering of the temperature. The next phase includes a set point for the cell probe -12°C/10.4°F. The first phase ends when the product probe reaches 10°C/50°F, while the second phase ends when the product probe reaches the set point of 3°C/37.4°F. When the first phase ends, the FREEZING icon comes on steadily, while the CHILLING icon continues to flash. When the second phase ends, the cycle is considered complete and the conservation phase begins. The CHILLING and FREEZING icons come on steadily, whereas the CONSERVATION icon flashes and the buzzer, if included, sounds intermittently for 10 seconds. Press any key to silence the buzzer and the CONSERVATION icon will come on steadily. The display shows the temperature of the cell probe. During the conservation phase, the set point for adjustment of the cell probe is 3°C/37.4°F. The maximum time allowed for completion of the two phases is 90 min. If this

# Operation

---

time is exceeded when switching over to conservation, the display shows the cell probe temperature, while the TIME icon flashes to indicate that the time has been exceeded. In conservation mode, if you press and hold the CHILLING, HARD or FREEZING keys for three seconds, you will be shown the total amount of time used for the two phases. At any time, you can press the STANDBY key to stop running the cycle. The cycle remains selected. If you press the STANDBY key again the cycle starts from the beginning. To de-select the cycle, you only need to select another cycle, or press any key from among CHILLING, FREEZING or HARD. This will de-select everything.

## **VENTILATION DEFROSTING**

Defrosting can either be manual or automatic. Manual defrosting is started by pressing and holding the CHILLING and FREEZING keys for three seconds when the controller is in standby mode. Manual defrosting comes to an end by simultaneously pressing and holding the same keys for three seconds, due to a time overrun of 10 minutes or when the evaporator probe reaches 2°C/35.6°F. Automatic defrosting takes place during the conservation phase. The first automatic defrosting starts after a delay from the start of conservation for 40 seconds, and is repeated at 8 hour intervals. Automatic defrosting ends if the evaporator probe registers 2°C/35.6°F or the time overruns by 10 minutes. During manual or automatic defrosting, the display shows label "DEF". During a defrost cycle, whether manual or automatic, only the evaporator fans are active. For improved performance, it is advisable to leave the door open.

# Maintenance

---

## **ERRORS AND ALARMS**

Er 1: Cell probe failure. In standby mode, it prevents the start-up of chilling/freezing. In the chilling/freezing modes it stops the cycle and the controller goes back to standby mode. In the conservation mode, the cycle is not stopped and the compressor is activated in cycles. Check connections and operation of the cell probe.

Er 2: Product probe failure. In standby mode, it prevents the start-up of temperature-based chilling/freezing. In the temperature-based chilling/freezing modes, it causes changeover to a time-based cycle. In the conservation mode it does not have any effect. Check connections and operation of the product probe.

Er 3: Evaporator probe failure (only if the evaporator probe has been enabled). In standby, the chilling/freezing and conservation modes do not have any effect. Defrosting will be stopped by a time overrun. Check the connections and operation of the evaporator probe.

AL 1: Door open alarm. In the standby and defrost modes they do not have any effects. Door opening is not signalled immediately. After a pre-set time, the display shows "door" flashing; the door open alarm is given, and the display shows "AL 1". If there is a buzzer, an acoustic signal is also provided by a five-second beep repeated every fifteen seconds. The door open alarm does not sound during a ventilation defrost cycle. You have to close the door.

AL 2: High pressure alarm. In the standby mode it does not have any effect. In the chilling/freezing and conservation modes it stops the cycle and the controller goes back to standby mode. Stop the source of the

# Maintenance

---

alarm; turn the controller off and then back on. Activation of the high pressure alarm is signalled after a pre-established time. The display shows “AL 2” and the buzzer, if present, emits a five-second beep every fifteen seconds. Any cycle currently in progress is stopped and the controller goes back to standby. To reset, place the controller in the off status.

AL 4: Shaft not inserted. Each alarm status is accompanied by the sound of the buzzer (if included). The acoustic signal is composed of a five-second beep which is repeated every fifteen seconds. The label that indicates the alarm in progress is shown on the display and alternating with respect to the currently displayed information.

## CLEANING AND MAINTENANCE

A few simple operations carried out at set periods can avoid the need of servicing by specialized personnel. The operations to be made do not require any technical knowledge. Before beginning any type of maintenance or cleaning work on the appliance disconnect the plug from the power supply. Do not wash the appliance directly with high pressure water jets. Avoid spraying water directly onto the electrical parts.

**APPLIANCE:** Check that the body is clean. Pay particular attention to the steel sections. Clean the inside and outside surfaces only with warm water and a neutral detergent. Rinse with plenty of water and dry thoroughly. If the appliance is inactive for long periods of time proceed as follows: turn the power switch to the OFF position. Remove the plug from its socket. Empty the appliance and clean. Leave the door half-open to avoid the creation of bad smells. Protect the compressor from dust.

**CORE PROBE:** Clean the edge before and after every use. If it's not in use, after cleaning, cover with its rubber cap and place it in the proper side, within the appliance's chamber.

**CONDENSING COIL:** It is important that its surface is to be free of dirt or dust that may be deposited by the fan's operation. Use a vacuum cleaner and soft bristled brush to remove all the impurities such as paper or dust that may have deposited on the coil. Check that the aluminum fins have not been damaged or bent; if this is the case “comb” the coil with the appropriate tool until the original condition is regained to optimize the air flow.

**POWER CABLE:** Check that the power cable that connects the appliance to the power socket is not cut, cracked or altered in any way as to compromise the insulation. Contact Omcan if the power cable requires maintenance.

# Maintenance

## REFERENCE

Item Number	Model Number	Description	Manufacturer Model Number
41899	BC-IT-0103	Blast Chiller 3 Trays 13" x 21" 220V/60/1 QPS	BE-103L-HSO
45262	BC-IT-0905	Blast Chiller 5 Trays 18" x 26" 220V/60/1 QPS	BE-905T-LDO/OM
41317	BC-IT-0906	Blast Chiller 6 Trays 18" x 26" 220V/60/1 QPS	BE-906T-LDO/OM
45263	BC-IT-0910	Blast Chiller 10 Trays 18" x 26" 220V/6Z/1 QPS	BE-910T-LDO/OM

# Parts Breakdown

Model BC-IT-0103 41899

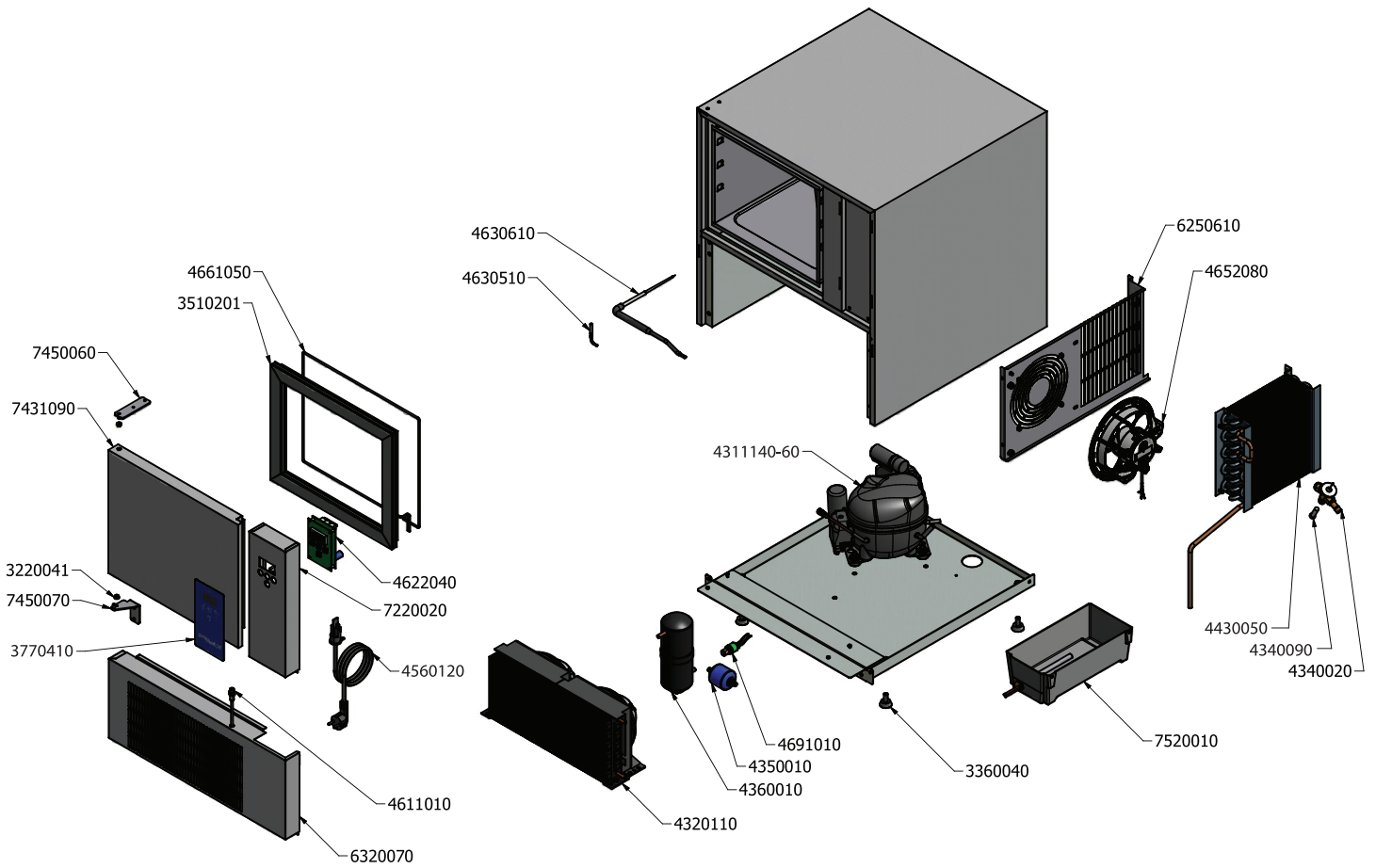

# Parts Breakdown

Model BC-IT-0905 45262

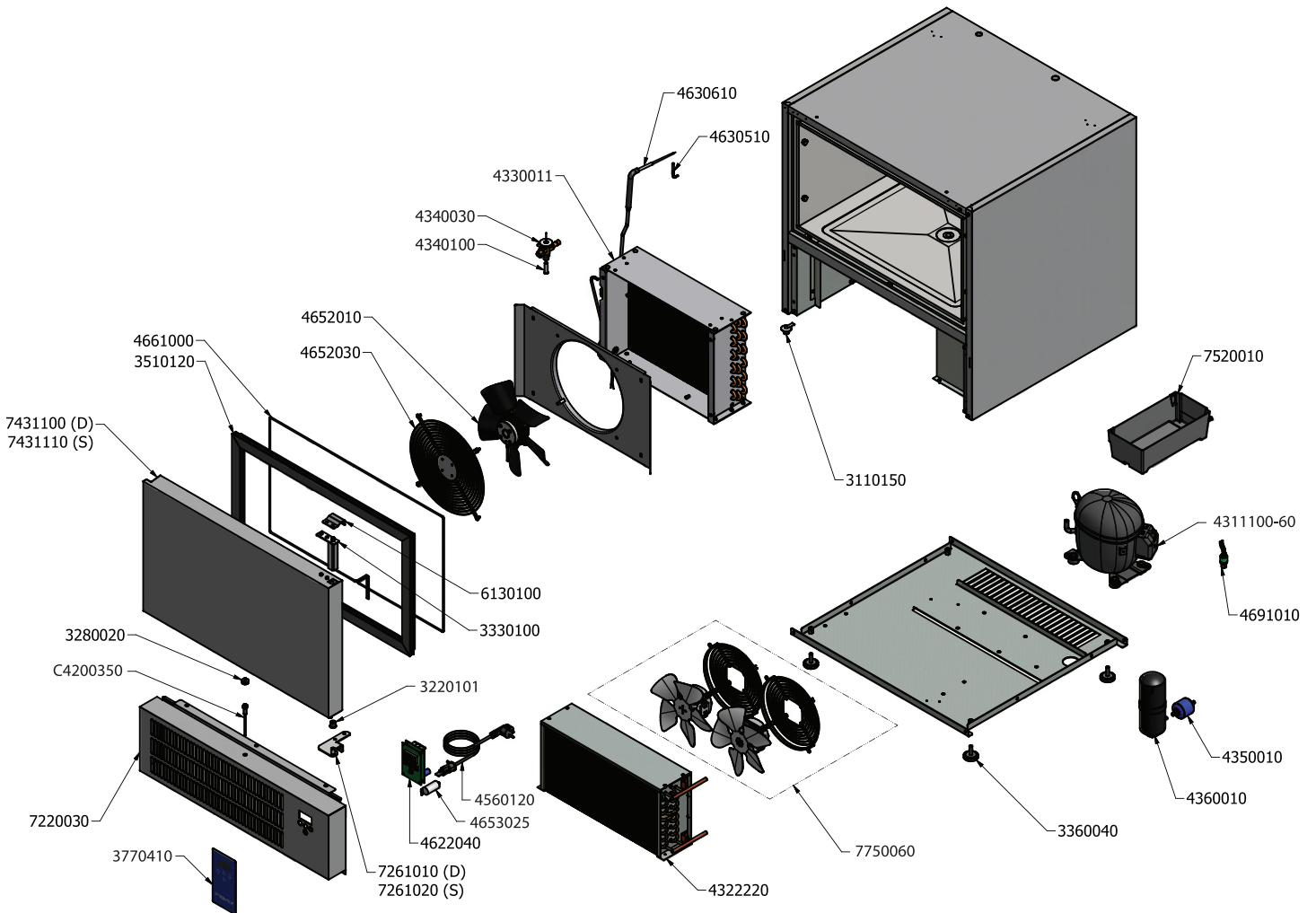

# Parts Breakdown

Model BC-IT-0906 41317

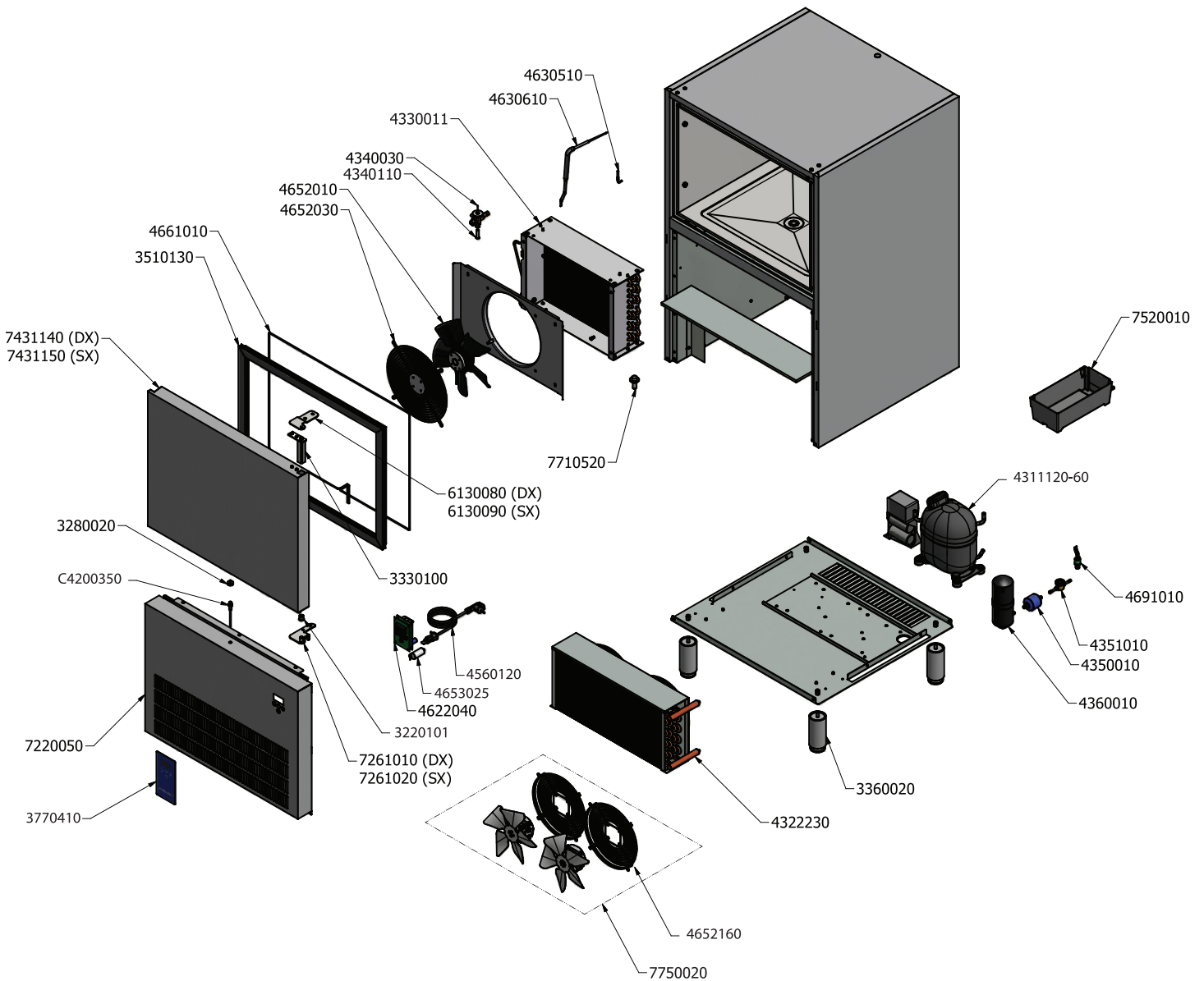

# Parts Breakdown

**Model BC-IT-0910 45263**

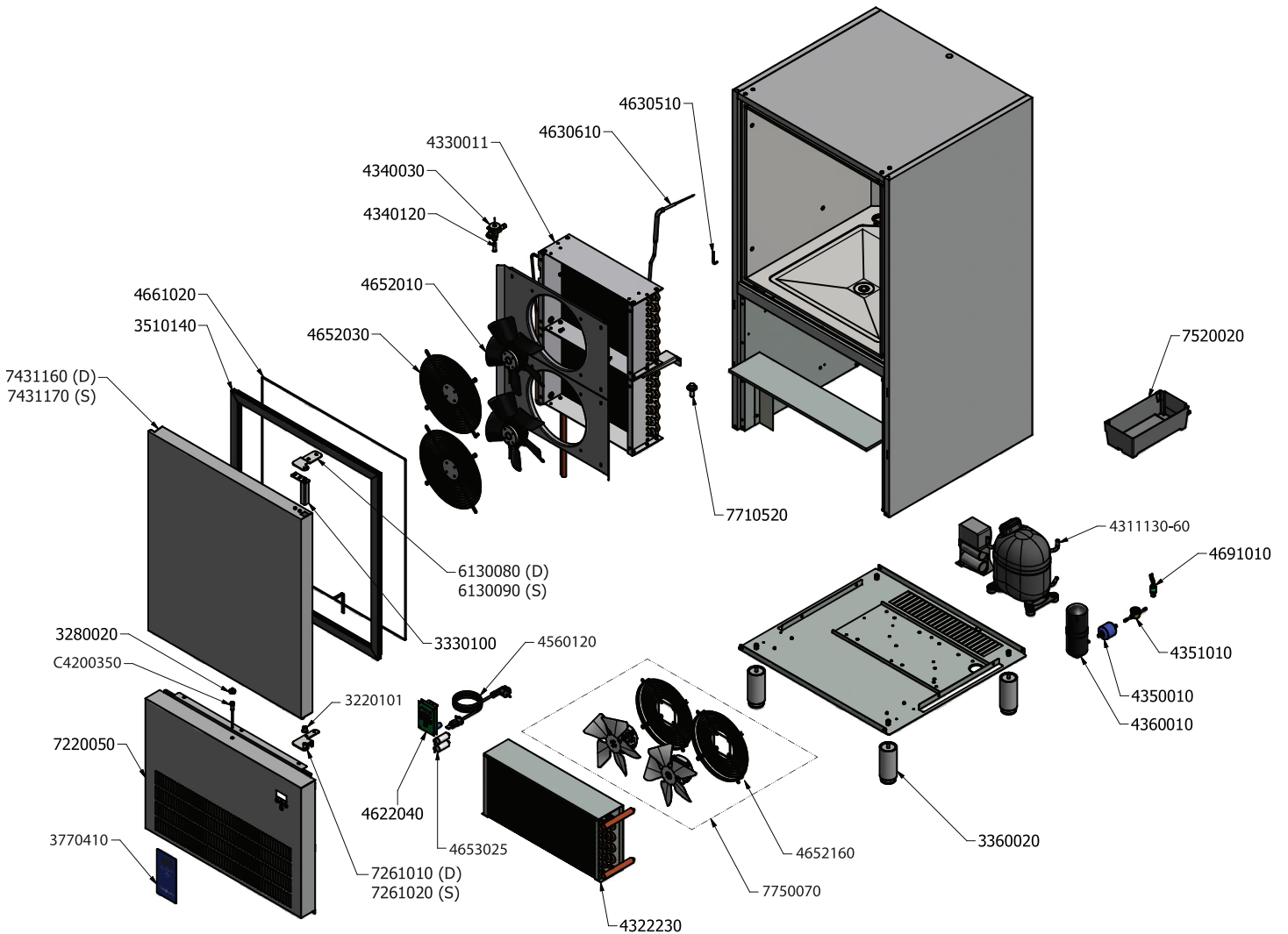

# Parts Breakdown

## Model BC-IT-0103 41899

Item No.	Description	Position	Item No.	Description	Position	Item No.	Description	Position
42066	Door Bush D9 H=1,5 for BE-103L-HSO	3220041	64930	Liquid Receiver 0.8 LT for BE-103L-HSO	4360010	42115	Pressure Switch 28BAR for BE-103L-HSO	4691010
42067	Feet H=20 D=45 M10 Black for BE-103L-HSO	3360040	42072	Evaporator AB-03 for BE-103L-HSO	4430050	42085	Evaporator Conveyor AB-03 for BE-103L-HSO	6250610
42068	Door Magnet Gasket AB-03 D7 for BE-103L-HSO	3510201	42106	Cable AVG SJT L=3500 UL Terminal Board PA84 for BE-103L-HSO	4560120	44036	Inferior Panel AB-03 for BE-103L-HSO	6320070
42097	Adhesive Control Panel AB-03 for BE-103L-HSO	3770410	42107	Door Switch N.O. L=130 for BE-103L-HSO	4611010	42087	Stainless Steel Panel for Adhesive Mask AB-03 for BE-103L-HSO	7220020
42070	Compressor ASP NEK2150GK for BE-103L-HSO	4311140-60	42108	Card EVC80S11P7CLT00 AB 2RELE for BE-103L-HSO	4622040	42088	Foamed Door AB-G1-03 SX for BE-103L-HSO	7431090
42071	Air Condenser STVF157 for BE-103L-HSO	4320110	42109	Chamber Probe PTC L=2500 Gray for BE-103L-HSO	4630510	42089	Superior Flat Door Hinge AB-03 for BE-103L-HSO	7450060
42073	Valve TS2 40+10 R404A for BE-103L-HSO	4340020	42110	Core Probe PTC 1000 L=3000 Gray for BE-103L-HSO	4630610	42090	Inferior Door Hinge AB-03 for BE-103L-HSO	7450070
42074	Conic Orifice 00 for BE-103L-HSO	4340090	42082	Fan W1G172-EC91-01 for BE-103L-HSO	4652080	42120	Evaporation Water Tank 190W L=1500 for BE-103L-HSO	7520010
42075	Filter 50x6mm for BE-103L-HSO	4350010	42083	Frame Heating Element AB-03 15W/M for BE-103L-HSO	4661050			

## Model BC-IT-0905 45262

Item No.	Description	Position	Item No.	Description	Position	Item No.	Description	Position
64968	Drainage Plug 1/2" for BE-905T-LDO/OM	3110150	64966	Flat Inlet TE2 N° 00 ODF for BE-905T-LDO/OM	4340100	64961	Right Superior Hinge for BE-905T-LDO/O	6130100
42092	Door Bush FC D13 H=2 for BE-905T-LDO/OM	3220101	42075	Filter 50x6mm for BE-905T-LDO/OM	4350010	64962	Inferior Panel AB ECO-E4-05 for BE-905T-LDO/OM	7220030
42093	Round Magnet D=22 for BE-905T-LDO/OM	3280020	64930	Liquid Receiver 0.8 LT for BE-905T-LDO/OM	4360010	42118	Right Inferior Hinge for BE-905T-LDO/OM	7261010
42094	Door Pivot Hinge 28L S/F-13 for BE-905T-LDO/OM	3330100	42106	Cable AVG SJT L=3500 UL Terminal Board PA84 for BE-905T-LDO/OM	4560120	44037	Left Inferior Hinge for BE-905T-LDO/OM	7261020
42067	Feet H=20 D=45 M10 Black for BE-905T-LDO/OM	3360040	42108	Card EVC80S11P7CLT00 AB 2RELE for BE-905T-LDO/OM	4622040	64963	Foamed Door AB ECO-E4-05 DX for BE-905T-LDO/OM	7431100
64959	Door Magnet Gasket AB-E4-05 for BE-905T-LDO/OM	3510120	42109	Chamber Probe PTC L=2500 Gray for BE-905T-LDO/OM	4630510	64967	Foamed Door AB-E4-05 LE ECO for BE-905T-LDO/OM	7431110
42097	Adhesive Control Panel AB-03 for BE-905T-LDO/OM	3770410	42110	Core Probe PTC 1000 L=3000 Gray for BE-905T-LDO/OM	4630610	42120	Evaporation Water Tank 190W L=1500 for BE-905T-LDO/OM	7520010
64969	Compressor ASP NT2178GK - R404A for BE-905T-LDO/OM	4311100-60	42112	Stainless Steel Flat Grate ZHIEL D300 for BE-905T-LDO/OM	4652030	64970	Kit Fan Condenser Motor+Vent. AB for BE-905T-LDO/OM	7750010
64971	Air Condenser 4R 2x230 36TU for BE-905T-LDO/OM	4322220	42113	Electric Condenser 2MF for BE-905T-LDO/OM	4653025	42111	ZHIEL Fan AB D=300 + 2COND for BE-905T-LDO/OM	7750060
42100	Evaporator AB-06 for BE-905T-LDO/OM	4330011	64960	Frame Heating Element AB05T 15W/M for BE-905T-LDO/OM	4661000	42107	Door Switch N.O. L=130 for BE-905T-LDO/OM	C4200350
42101	Valve TES2 -40+10 R404A for BE-905T-LDO/OM	4340030	42115	Pressure Switch 28BAR for BE-905T-LDO/OM	4691010			

# Parts Breakdown

## Model BC-IT-0906 41317

Item No.	Description	Position	Item No.	Description	Position	Item No.	Description	Position
42092	Door Bush FC D13 H=2 for BE-906T-LDO/OM	3220101	42075	Filter 50x6mm for BE-906T-LDO/OM	4350010	42116	Right Superior Hinge for BE-906T-LDO/OM	6130080
42093	Round Magnet D=22 for BE-906T-LDO/OM	3280020	42104	Liquid Indicator 6mm for BE-906T-LDO/OM	4351010	44035	Left Superior Hinge for BE-906T-LDO/OM	6130090
42094	Door Pivot Hinge 28L S/F-13 for BE-906T-LDO/OM	3330100	64930	Liquid Receiver 0.8 LT for BE-906T-LDO/OM	4360010	42117	Inferior Panel AB ECO-E4-06-10 for BE-906T-LDO/OM	7220050
42095	Feet 2" H=150 Screw M10x25 for BE-906T-LDO/OM	3360020	42106	Cable AVG SJT L=3500 UL Terminal Board PA84 for BE-906T-LDO/OM	4560120	42118	Right Inferior Hinge for BE-906T-LDO/OM	7261010
42096	Door Magnet Gasket AB-E4-06 for BE-906T-LDO/OM	3510130	42108	Card EVC80S11P7CLT00 AB 2RELE for BE-906T-LDO/OM	4622040	44037	Left Inferior Hinge for BE-906T-LDO/OM	7261020
42097	Adhesive Control Panel AB-03 for BE-906T-LDO/OM	3770410	42109	Chamber Probe PTC L=2500 Gray for BE-906T-LDO/OM	4630510	42119	Foamed Door AB ECO-E4-06 DX for BE-906T-LDO/OM	7431140
42098	Compressor ASP NJ2192GK R404A for BE-906T-LDO/OM	4311120-60	42110	Core Probe PTC 1000 L=3000 Gray for BE-906T-LDO/OM	4630610	44038	Foamed Door AB ECO-E4-06 SX for BE-906T-LDO/OM	7431150
42099	Air Condenser 4R 2x250 for BE-906T-LDO/OM	4322230	42112	Stainless Steel Flat Grate ZHIEL D300 for BE-906T-LDO/OM	4652160	42120	Evaporation Water Tank 190W L=1500 for BE-906T-LDO/OM	7520010
42100	Evaporator AB-06 for BE-906T-LDO/OM	4330011	42113	Electric Condenser 2MF for BE-906T-LDO/OM	4653025	42121	Water Drain Plug AB for BE-906T-LDO/OM	7710520
42101	Valve TES2 -40+10 R404A for BE-906T-LDO/OM	4340030	42114	Frame Heating Element AB06T 15W/M for BE-906T-LDO/OM	4661010	42111	ZHIEL Fan AB D=300 + 2COND for BE-906T-LDO/OM	7750060
42102	Conic Orifice 01 for BE-906T-LDO/OM	4340110	42115	Pressure Switch 28BAR for BE-906T-LDO/OM	4691010	42107	Door Switch N.O. L=130 for BE-906T-LDO/OM	C4200350

## Model BC-IT-0910 45263

Item No.	Description	Position	Item No.	Description	Position	Item No.	Description	Position
42092	Door Bush FC D13 H=2 for BE-910T-LDO/OM	3220101	42104	Liquid Indicator 6mm for BE-910T-LDO/OM	4351010	42117	Inferior Panel AB ECO-E4-06-10 for BE-910T-LDO/OM	7220050
42093	Round Magnet D=22 for BE-910T-LDO/OM	3280020	64930	Liquid Receiver 0.8 LT for BE-910T-LDO/OM	4360010	42118	Right Inferior Hinge for BE-910T-LDO/OM	7261010
42094	Door Pivot Hinge 28L S/F-13 for BE-910T-LDO/OM	3330100	42106	Cable AVG SJT L=3500 UL Terminal Board PA84 for BE-910T-LDO/OM	4560120	44037	Left Inferior Hinge for BE-910T-LDO/OM	7261020
42095	Feet 2" H=150 Screw M10x25 for BE-910T-LDO/OM	3360020	42108	Card EVC80S11P7CLT00 AB 2RELE for BE-910T-LDO/OM	4622040	64957	Foamed Door AB ECO-E4-10 DX for BE-910T-LDO/OM	7431160
64917	Door Magnet Gasket AB-E4-10 for BE-910T-LDO/OM	3510140	42109	Chamber Probe PTC L=2500 Gray for BE-910T-LDO/OM	4630510	64965	Foamed Door AB-E4-10 LE ECO for BE-910T-LDO/OM	7431170
42097	Adhesive Control Panel AB-03 for BE-910T-LDO/OM	3770410	42110	Core Probe PTC 1000 L=3000 Gray for BE-910T-LDO/OM	4630610	64958	Evaporation Water Tank 270W L=1500 for BE-910T-LDO/OM	7520020
64929	Compressor ASP NJ2212GK R404A for BE-910T-LDO/OM	4311130-60	42112	Stainless Steel Flat Grate ZHIEL D300 for BE-910T-LDO/OM	4652160	42121	Water Drain Plug AB for BE-910T-LDO/OM	7710520
42099	Air Condenser 4R 2x250 for BE-910T-LDO/OM	4322230	42113	Electric Condenser 2MF for BE-910T-LDO/OM	4653025	44039	Condenser Fan and Flat Grate for BE-910T-LDO/OM	7750020
42100	Evaporator AB-06 for BE-910T-LDO/OM	4330011	64931	Frame Heating Element AB10T 15W/M for BE-910T-LDO/OM	4661020	42111	ZHIEL Fan AB D=300 + 2COND for BE-910T-LDO/OM	7750060
42101	Valve TES2 -40+10 R404A for BE-910T-LDO/OM	4340030	42115	Pressure Switch 28BAR for BE-910T-LDO/OM	4691010	42107	Door Switch N.O. L=130 for BE-910T-LDO/OM	C4200350
64964	Flat Inlet TE2 N° 02 ODF for BE-910T-LDO/OM	4340120	42116	Right Superior Hinge for BE-910T-LDO/OM	6130080			
42075	Filter 50x6mm for BE-910T-LDO/OM	4350010	44035	Left Superior Hinge for BE-910T-LDO/OM	6130090			

# Electrical Schematics

**Model BC-IT-0103** 41899

**Model BC-IT-0905** 45262

**Model BC-IT-0906** 41317

**Model BC-IT-0910** 45263

- A3 : DOOR MICROSWITCH
- C1 : ELECTRIC CONDENSER
- E2 : CONTROL BOARD
- E3 : KEY BOARD
- M1 : COMPRESSOR
- M2 : CONDENSER FAN
- M3 : EVAPORATOR FAN
- M4 : EVAPORATOR FAN
- P1 : TEMPERATURE PROBE
- P3 : CORE PROBE
- Q1 : HIGH PRESSURE SWITCH
- R1 : FRAME HEATER
- R3 : EVAPORATION HEATING ELEMENT

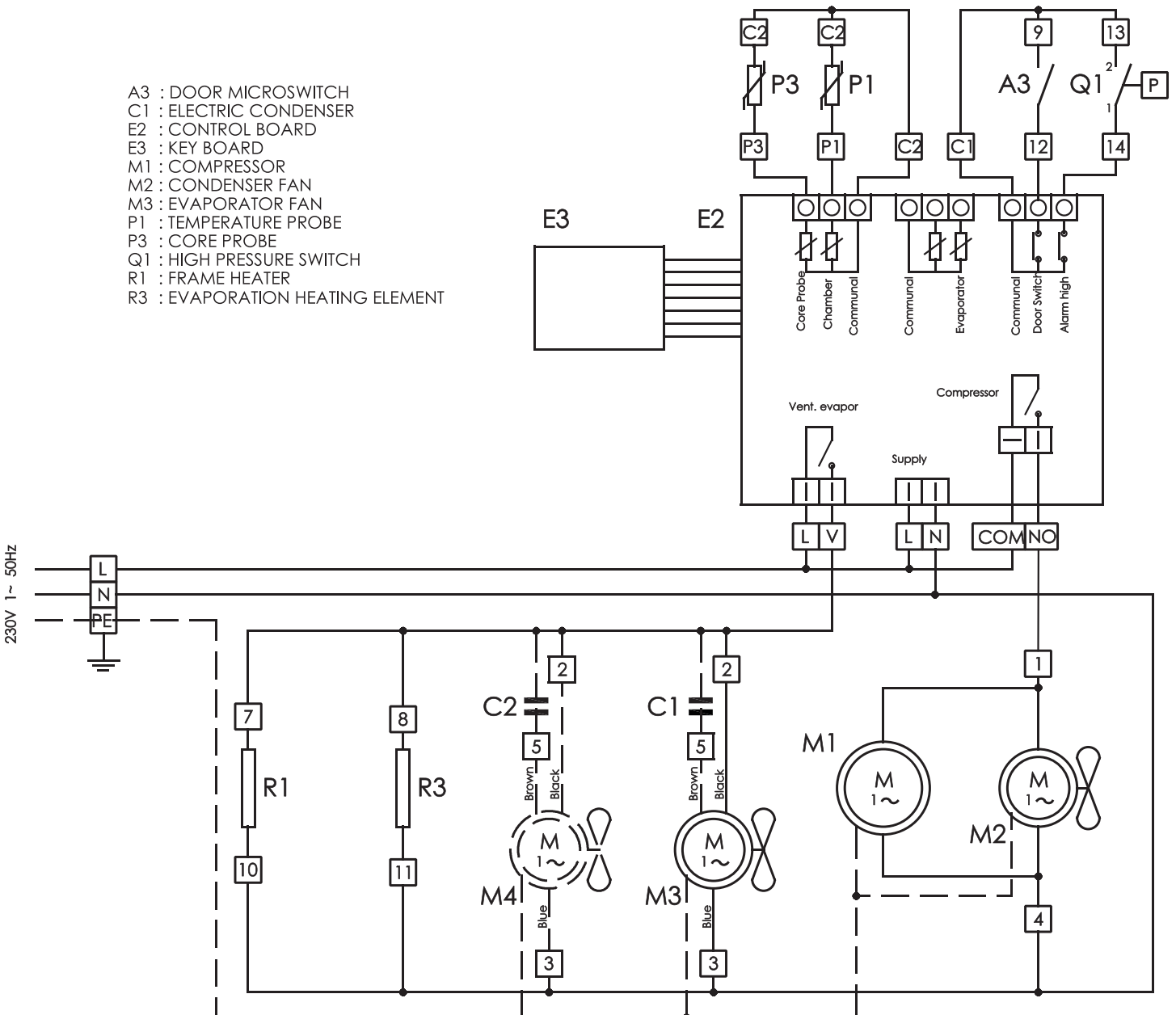







# Warranty Registration

Thank you for purchasing an Omcan product. To register your warranty for this product, complete the information below, tear off the card at the perforation and then send to the address specified below. You can also register online by visiting:

Merci d'avoir acheté un produit Omcan. Pour enregistrer votre garantie pour ce produit, complétez les informations ci-dessous, détachez la carte au niveau de la perforation, puis l'envoyer à l'adresse spécifiée ci-dessous. Vous pouvez également vous inscrire en ligne en visitant:

Gracias por comprar un producto Omcan usted. Para registrar su garantía para este producto, complete la información a continuación, cortar la tarjeta en la perforación y luego enviarlo a la dirección indicada a continuación. También puede registrarse en línea en:

[www.omcan.com/warrantyregistration.html](http://www.omcan.com/warrantyregistration.html)

For mailing in Canada

Pour postale au Canada

Por correo en Canadá

**OMCAN**

PRODUCT WARRANTY REGISTRATION

3115 Pepper Mill Court,

Mississauga, Ontario

Canada, L5L 4X5

For mailing in the US

Pour diffusion aux États-Unis

Por correo en los EE.UU.

**OMCAN**

PRODUCT WARRANTY REGISTRATION

4450 Witmer Industrial Estates, Unit 4,

Niagara Falls, New York

USA, 14305

*or email to: [service@omcan.com](mailto:service@omcan.com)*



Purchaser's Information

Name: \_\_\_\_\_

Address: \_\_\_\_\_

City: \_\_\_\_\_ Province or State: \_\_\_\_\_ Postal or Zip: \_\_\_\_\_

Country: \_\_\_\_\_

Dealer from which Purchased: \_\_\_\_\_

Dealer City: \_\_\_\_\_ Dealer Province or State: \_\_\_\_\_

Invoice: \_\_\_\_\_

Model Name: \_\_\_\_\_ Model Number: \_\_\_\_\_

Machine Description: \_\_\_\_\_

Date of Purchase (MM/DD/YYYY): \_\_\_\_\_

Would you like to extend the warranty?  Yes  No

Company Name: \_\_\_\_\_

Telephone: \_\_\_\_\_

Email Address: \_\_\_\_\_

Type of Company:

Restaurant  Bakery  Deli

Butcher  Supermarket  Caterer

Institution (*specify*): \_\_\_\_\_

Other (*specify*): \_\_\_\_\_

Serial Number: \_\_\_\_\_

Date of Installation (MM/DD/YYYY): \_\_\_\_\_

**Thank you for choosing Omcan | Merci d'avoir choisi Omcan | Gracias por elegir Omcan**



Since 1951 Omcan has grown to become a leading distributor of equipment and supplies to the North American food service industry. Our success over these many years can be attributed to our commitment to strengthen and develop new and existing relationships with our valued customers and manufacturers. Today with partners in North America, Europe, Asia and South America, we continually work to improve and grow the company. We strive to offer customers exceptional value through our qualified local sales and service representatives who provide convenient access to over 3,500 globally sourced products.

---

Depuis 1951 Omcan a grandi pour devenir un des “leaders” de la distribution des équipements et matériel pour l’industrie des services alimentaires en Amérique du Nord. Notre succès au cours de ces nombreuses années peut être attribué à notre engagement à renforcer et à développer de nouvelles et existantes relations avec nos clients et les fabricants de valeur. Aujourd’hui avec des partenaires en Amérique du Nord, Europe, Asie et Amérique du Sud, nous travaillons continuellement à améliorer et développer l’entreprise. Nous nous efforçons d’offrir à nos clients une valeur exceptionnelle grâce à nos ventes locales qualifiées et des représentants de service qui offrent un accès facile à plus de 3500 produits provenant du monde entier.

---

Desde 1951 Omcan ha crecido hasta convertirse en un líder en la distribución de equipos y suministros de alimentos en América del Norte industria de servicios. Nuestro éxito en estos años se puede atribuir a nuestro compromiso de fortalecer y desarrollar nuevas relaciones existentes con nuestros valiosos clientes y fabricantes. Hoy con socios de América del Norte, Europa, Asia y América del Sur, que trabajan continuamente para mejorar y crecer la empresa. Nos esforzamos por ofrecer a nuestros clientes valor excepcional a través de nuestro local de ventas y representantes de los servicios que proporcionan un fácil acceso a más de 3,500 productos con origen a nivel mundial.

