



**Blenders**  
*Models BL-BR-0015, 0025*  
*Items 37969, 31502*  
**Instruction Manual**



*Revised - 05/25/2018*



Toll Free: 1-800-465-0234  
Fax: 905-607-0234  
Email: [service@omcan.com](mailto:service@omcan.com)  
[www.omcan.com](http://www.omcan.com)

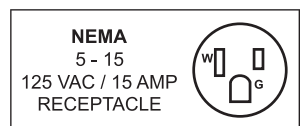

# ***Table of Contents***

Model BL-BR-0015 / Model BL-BR-0025

---

<b>Section</b>	<b>Page</b>
General Information -----	3 - 4
Safety and Warranty -----	4 - 6
Technical Specifications -----	7
Installation -----	7 - 8
Operation -----	8 - 9
Maintenance -----	9 - 11
Parts Breakdown -----	12 - 15
Electrical Schematics -----	16 - 17
Notes -----	18
Warranty Registration -----	19



# General Information

---

Omcan Manufacturing and Distributing Company Inc., Food Machinery of America, Inc. dba Omcan and Omcan Inc. are not responsible for any harm or injury caused due to any person's improper or negligent use of this equipment. The product shall only be operated by someone over the age of 18, of sound mind, and not under the influence of any drugs or alcohol, who has been trained in the correct operation of this machine, and is wearing authorized, proper safety clothing. Any modification to the machine voids any warranty, and may cause harm to individuals using the machine or in the vicinity of the machine while in operation.

## CHECK PACKAGE UPON ARRIVAL

Upon receipt of an Omcan shipment please inspect for external damage. If no damage is evident on the external packaging, open carton to ensure all ordered items are within the box, and there is no concealed damage to the machine. If the package has suffered rough handling, bumps or damage (visible or concealed), please note it on the bill of lading before accepting the delivery and contact Omcan within 24 hours, so we may initiate a claim with the carrier. A detailed report on the extent of the damage caused to the machine must be filled out within three days, from the delivery date shown in the shipping documents. Omcan has no recourse for damaged products that were shipped collect or third party.

**Before operating any equipment, always read and familiarize yourself with all operation and safety instructions.**

Omcan would like to thank you for purchasing this machine. It's of the utmost importance to save these instructions for future reference. Also save the original box and packaging for shipping the equipment if servicing or returning of the machine is required.

---

Omcan Fabrication et distribution Compañie Limité et Food Machinery d'Amérique, dba Omcan et Omcan Inc. ne sont pas responsables de tout dommage ou blessure causé du fait que toute personne ait utilisé cet équipement de façon irrégulière. Le produit ne doit être exploité que par quelqu'un de plus de 18 ans, saine d'esprit, et pas sous l'influence d'une drogue ou d'alcool, qui a été formé pour utiliser cette machine correctement, et est vêtu de vêtements de sécurité approprié. Toute modification de la machine annule toute garantie, et peut causer un préjudice à des personnes utilisant la machine ou des personnes à proximité de la machine pendant son fonctionnement.

## VÉRIFIEZ LE COLIS DÈS RÉCEPTION

Dès réception d'une expédition d'Omcan veuillez inspecter pour dommages externes. Si aucun dommage n'est visible sur l'emballage externe, ouvrez le carton afin de s'assurer que tous les éléments commandés sont dans la boîte, et il n'y a aucun dommage dissimulé à la machine. Si le colis n'a subi aucune mauvaises manipulations, de bosses ou de dommages (visible ou cachée), notez-le sur le bond de livraison avant d'accepter la livraison et contactez Omcan dans les 24 heures qui suivent, pour que nous puissions engager une réclamation auprès du transporteur. Un rapport détaillé sur l'étendue des dommages causés à la machine doit être rempli dans un délai de trois jours, à compter de la date de livraison indiquée dans les documents d'expédition. Omcan n'a aucun droit de recours pour les produits endommagés qui ont été expédiés ou cueilli par un tiers transporteur.

# General Information

---

Avant d'utiliser n'importe quel équipement, toujours lire et vous familiariser avec toutes les opérations et les consignes de sécurité.

Omcan voudrais vous remercier d'avoir choisi cette machine. Il est primordial de conserver ces instructions pour une référence ultérieure. Également conservez la boîte originale et l'emballage pour l'expédition de l'équipement si l'entretien ou le retour de la machine est nécessaire.

---

Omcan Empresa De Fabricacion Y Distribucion Inc. Y Maquinaria De Alimentos De America, Inc. dba Omcan y Omcan Inc. no son responsables de ningun daño o perjuicio causado por cualquier persona inadecuada o el uso descuidado de este equipo. El producto solo podra ser operado por una persona mayor de 18 años, en su sano juicio y no bajo alguna influencia de droga o alcohol, y que este ha sido entrenado en el correcto funcionamiento de esta máquina, y ésta usando ropa apropiada y autorizada. Cualquier modificación a la máquina anula la garantía y puede causar daños a las personas usando la máquina mientras esta en el funcionamiento.

## REVISE EL PAQUETE A SU LLEGADA

Tras la recepcion de un envio Omcan favor inspeccionar daños externos. Si no hay daños evidentes en el empaque exterior, Habra el carton para asegurarse que todos los articulos solicitados estén dentro de la caja y no encuentre daños ocultos en la máquina. Si el paquete ha sufrido un manejo de poco cuidado, golpes o daños (visible o oculto) por favor anote en la factura antes de aceptar la entrega y contacte Omcan dentro de las 24 horas, de modo que podamos iniciar una reclamación con la compañía. Un informe detallado sobre los daños causados a la máquina debe ser llenado en el plazo de tres días, desde la fecha de entrega que se muestra en los documentos de envío. Omcan no tiene ningun recurso por productos dañados que se enviaron a recoger por terceros.

Antes de utilizar cualquier equipo, siempre lea y familiarizarse con todas las instrucciones de funcionamiento y seguridad.

Omcan le gustaría darle las gracias por la compra de esta máquina. Es de la mayor importancia para salvar estas instrucciones para futuras consultas. Además, guarda la caja original y el embalaje para el envío del equipo si servicio técnico o devolución de la máquina que se requiere.

# Safety and Warranty

---

The High Performance Tilting Blenders are simple to use and clean. However, for your safety read the following instructions in order to avoid accidents:

1. Always unplug the machine when cleaning, servicing or when any other maintenance operation is needed.
2. Never use tools that do not belong to the machine during operation.
3. Never spray water on the machine.
4. Do not operate the machine while wearing wet clothes or wet shoes.
5. Before operating the machine, make sure it is properly grounded.

# Safety and Warranty

6. When washing inside of the Cup N°02 (Pic. 01) ensure power is off and unit is unplugged. Be careful with the blade as it has sharp edges.



## GENERAL SAFETY PRACTICES

The following safety instructions are addressed to both the operator of the machine as well as the person in charge of maintenance. The user shall operate the machine only after being well acquainted with the safety procedures described in the present manual. **READ THIS MANUAL THOROUGHLY.**

## BASIC OPERATION PRACTICES

### Dangerous parts

Some parts of the electric devices are connected to high voltage points. These parts when touched may cause severe electrical shocks or can even be **FATAL**. Never touch commands such as buttons, switches and knobs with wet hands, wet clothes and/or shoes. By not following these instructions, operators could be exposed to severe electrical shocks or even to a **FATAL** situation.

### Warnings

The operator has to be well familiar with the position of **ON/OFF** Switch to make sure the Switch is easily accessible when necessary. Before any kind of maintenance, physically remove plug from the socket. Provide space for a comfortable operation thus avoiding accidents. Water or oil spilled on the floor will cause additional hazards. Make sure the floor is clean and dry. Before giving any manual command (switch, buttons, turn keys or lever) be sure the command is the correct one. Check this manual for further details if necessary. Never use a manual command (switch, buttons, lever) unadvisedly. If any work is to be made by two or more people, coordination signs will have to be given for each operation step. Every step of the operation shall be taken only if the sign has been made and responded.

### Advices

In case of power shortage, immediately turn the machine **OFF**. Use recommended or equivalent lubricants, oils or greases. Avoid mechanical shocks as they may cause failures or malfunction. Avoid penetration of water, dirt or dust into mechanical or electrical components of the machine. **DO NOT MODIFY** original characteristics of the machine. **DO NOT REMOVE, TEAR OFF or MACULATE ANY SAFETY or IDENTIFICATION LABELS** stuck on the machine. If any label has been removed or is no longer legible, contact your nearest dealer for replacement.

# ***Safety and Warranty***

---

## **SAFETY PROCEDURES AND NOTES BEFORE SWITCHING MACHINE ON**

**IMPORTANT:** Carefully read **ALL INSTRUCTIONS** of this manual before turning the machine **ON**. Be sure to be familiar with the instructions and that you have understood all information contained in this manual. If you have any questions contact your supervisor or your nearest Dealer.

### **Danger**

An electric cable or electric wire with damaged jacket or bad insulation could cause electrical shocks as well as electrical leak. Before use, unplug and check conditions of all wires and cables.

### **Advices**

Be sure **ALL INSTRUCTIONS** in this manual have been thoroughly understood. Every function and operational procedure have to be very clear to the operator. Contact your nearest Dealer for further questions. Any manual command (switch, button or lever) shall be given only after being sure it is the correct one.

### **Precautions**

The electric cable has to be compatible with the power required by the machine. Cables touching the floor or close to the machine need to be protected against short circuits.

## **1 YEAR PARTS AND LABOUR BENCH WARRANTY**

Within the warranty period, contact Omcan Inc. at 1-800-465-0234 to schedule a drop off to either an Omcan authorized service depot in the area, or to an Omcan Service warehouse to repair the equipment.

Unauthorized maintenance will void the warranty. Warranty covers electrical and part failures, not improper use.

Please see [www.omcan.com/warranty.html](http://www.omcan.com/warranty.html) for complete info.

### **WARNING:**

The packaging components (cardboard, polyethylene, and others) are classified as normal solid urban waste and can therefore be disposed of without difficulty.

In any case, for suitable recycling, we suggest disposing of the products separately (differentiated waste) according to the current norms.

**DO NOT DISCARD ANY PACKAGING MATERIALS IN THE ENVIRONMENT!**

# Technical Specifications

## MAIN COMPONENTS

All components are made with carefully selected materials, in accordance with Omcan experience and standard testing procedures.

- 01- Lid
- 02- Cup
- 03- On/Off Switch
- 04- Stand
- 05- Motor
- 06- Lock Pedal

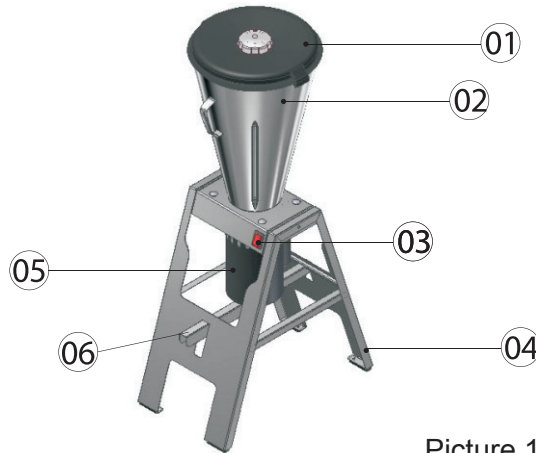

Picture 1

Model	BL-BR-0015	BL-BR-0025
HP	1.5	
Cup Capacity	15 L / 16 QT	25 L / 26 QT
Rotation	3500	
Electrical	110V/60/1	
Weight	41.75 lbs. / 18.9 kgs.	45.2 lbs. / 20.5 kgs.
Packaging Weight	65 lbs. / 29.5 kgs.	70.3 lbs. / 31.9 kgs.
Dimensions	20.75" x 14.25" x 41.75" 527 x 362 x 1060mm	20.9" x 16.1" x 46.5" 531 x 409 x 1181mm
Packaging Dimensions	23" x 16" x 44" 584 x 406 x 1118mm	23" x 16" x 50" 584 x 406 x 1270mm
Item Number	37969	31502

## Installation

The High Performance Tilting Blenders were developed to be used in 110V. **Grounding is mandatory.**

# Installation

---

## PRE OPERATION

First of all check if the Blender is firm on its position. Check if Motor (N°01) is perfectly fitted on the Lock Pedal (N°02) as shown on Picture 2.

01 - Motor  
02 - Pedal Lock.



Picture 2

**IMPORTANT:** Before doing any maintenance to the machine switch it **OFF** and unplug it.

# Operation

---

## STARTING

The Blender is activated by turning the On/Off Switch N°03 (Pic.01) to **ON** position.

## OPERATING PROCEDURES

The High Performance Tilting Blender works at high speed (approximately 3.500 rpm, 50Hz). To feed it proceed as follows:

1. Remove the Lid N°01 (Pic.01).
2. Put product inside the Cup N°02 (Pic.01) with the machine switched **OFF**.
3. Place the Lid N°01 (Pic.01) back on top of the Cup and switch the machine **ON**.

**NOTE:** Due to turbulence generated when machine is **ON** do not turn it **ON** without the Lid N°01 (Pic.01). The processing time depends on the kind of product.

**IMPORTANT:** NEVER SWITCH THE MACHINE ON WITHOUT PRODUCT IN IT BECAUSE IT WILL CAUSE IRREPARABLE DAMAGES.

**IMPORTANT:** It is not recommended to blend products without the addition of any liquid, otherwise it will overheat and damage the Cup seal.

# Operation

## DISCHARGING PROCEDURES

To discharge processed product from Blender Models proceed as follows:

1. Turn machine OFF.
2. Remove Lid N°01 (Pic. 01).
3. Press Lock Pedal N°06 (Pic. 01) down.
4. Tilt Cup N°02 (Pic. 01) holding its handle and discharge processed product as needed.

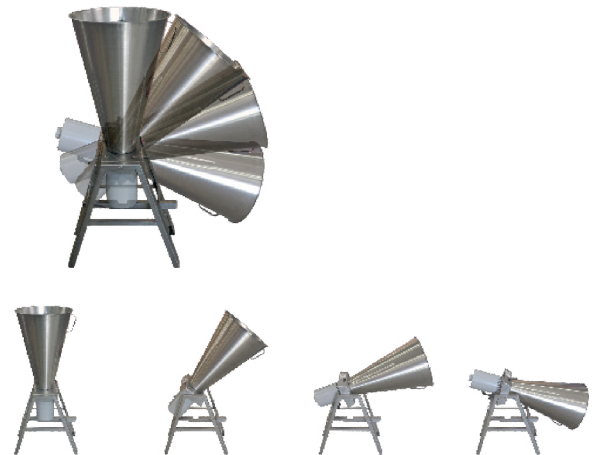

# Maintenance

## CLEANING

The new Blenders cup has stamped ribs that facilitate cleaning. Wash the Lid N°01 and the Cup N°02 (Pic. 01) with water and neutral soap. Wipe up the other parts with a damp cloth.

**IMPORTANT: Never do cleaning with machine plugged in. Always unplug machine before cleaning. When washing inside the Cup be careful with the blade.**

## MAINTENANCE

### Danger

Any maintenance with the machine in working situation is dangerous. **TURN IT OFF BY PULLING THE PLUG OFF THE SOCKET DURING MAINTENANCE.**

**IMPORTANT: Always unplug the machine when emergency cases arise.**

### Advice

Electrical or mechanical maintenance must be done by qualified personal for such operation. Person in charge has to be sure that the machine is under **TOTAL SAFETY** conditions when working.

## ROUTINE INSPECTION - UNPLUG MACHINE

### Advice

When checking the tension of the belts or chains, **DO NOT** introduce your fingers between the belts and the

# Maintenance

---

pulleys and nor between the chain and the gears.

## Precautions

Check if motors and sliding or turning parts of the machine produce abnormal noises. Check the tension of the belts and chains and replace the set when belt or chain show signs of being worn out. When checking tensions of belts or chain **DO NOT** introduce your fingers between belts and pulleys, nor between the chains and gears. Check protections and safety devices to make sure they are working properly.

## OPERATION

### Advice

Be sure your hair is not loose in order to avoid getting caught by turning parts which could lead to a serious accident. Tie your hair up and/or cover your head with a scarf. The operation performed by untrained personnel shall be forbidden. Never touch turning parts with your hands or in any other way. **NEVER** operate machine without all original safety devices under perfect conditions.

## CAUTIONS WITH STAINLESS STEEL:

The Stainless Steel may present rust signs, which **ARE ALWAYS CAUSED BY EXTERNAL AGENTS**, especially when the cleaning or sanitization is not constant and appropriate. The Stainless Steel resistance towards corrosion is mainly due to the presence of chrome, which in contact with oxygen allows the formation of a very thin protective coat. This protective coat is formed through the whole surface of the steel, blocking the action of external corrosive agents. When the protective coat is broken, the corrosion process begins, being possible to avoid it by means of constant and adequate cleaning. Cleaning must always be done immediately after using the equipment. For such end, use water, neutral soap or detergent, and clean the equipment with a soft cloth or a nylon sponge. Then rinse it with plain running water, and dry immediately with a soft cloth, this way avoiding humidity on surfaces and especially on gaps. The rinsing and drying processes are extremely important to prevent stains and corrosion from arising.

**IMPORTANT: Acid solutions, salty solutions, disinfectants and some sterilizing solutions (hypochlorites, tetravalent ammonia salts, iodine compounds, nitric acid and others), must be AVOIDED, once it cannot remain for long in contact with the stainless steel.**

These substances attack the stainless steel due to the **CHLORINE** on its composition, causing corrosion spots (pitting). Even detergents used in domestic cleaning must not remain in contact with the stainless steel longer than necessary, being mandatory to remove it with plain water and then dry the surface completely.

### Use of abrasives:

Sponges or steel wool and carbon steel brushes, besides scratching the surface and compromising the stainless steel protection, leave particles that rust and react contaminating the stainless steel. That is why such products must not be used for cleaning and sanitization. Scrapings made with sharp instruments or similar must also be avoided.

### Main substances that cause stainless steel corrosion:

Dust, grease, acid solutions such as vinegar, fruit juices, etc., saltern solutions (brine), blood, detergents

# Maintenance

(except for the neutral ones), common steel particles, residue of sponges or common steel wool, and also other abrasives.

## ANALYSIS AND PROBLEMS SOLVING

### Problems, causes and solutions

The High Performance Tilting Blenders were designed to operate with the need of minimum maintenance but the natural wearing caused by long use of the equipment may occasionally cause some malfunctions. If such problem occurs with your Blender refer to Table below in which the most common situations are listed with recommended solutions.

Problems	Causes	Solutions
The machine does not turn on.	Lack of power.	Check if machine is plugged in and if there is power in the power supply source.
	Problem in the electric circuit of the machine.	Call technical assistance.
Cup is leaking.	Damaged seal.	Call technical assistance.

## REFERENCE

Item Number	Model Number	Description	Manufacturer Model Number
37969	BL-BR-0015	Blender Tilting 15 L / 4 Gal 1.5 HP / 1119 W 110V/60/1	LAR-15
31502	BL-BR-0025	Blender Tilting 25 L / 7 Gal 1.5 HP / 1119 W 110V/60/1	LAR-25

# Parts Breakdown

Model **BL-BR-0015** 37969

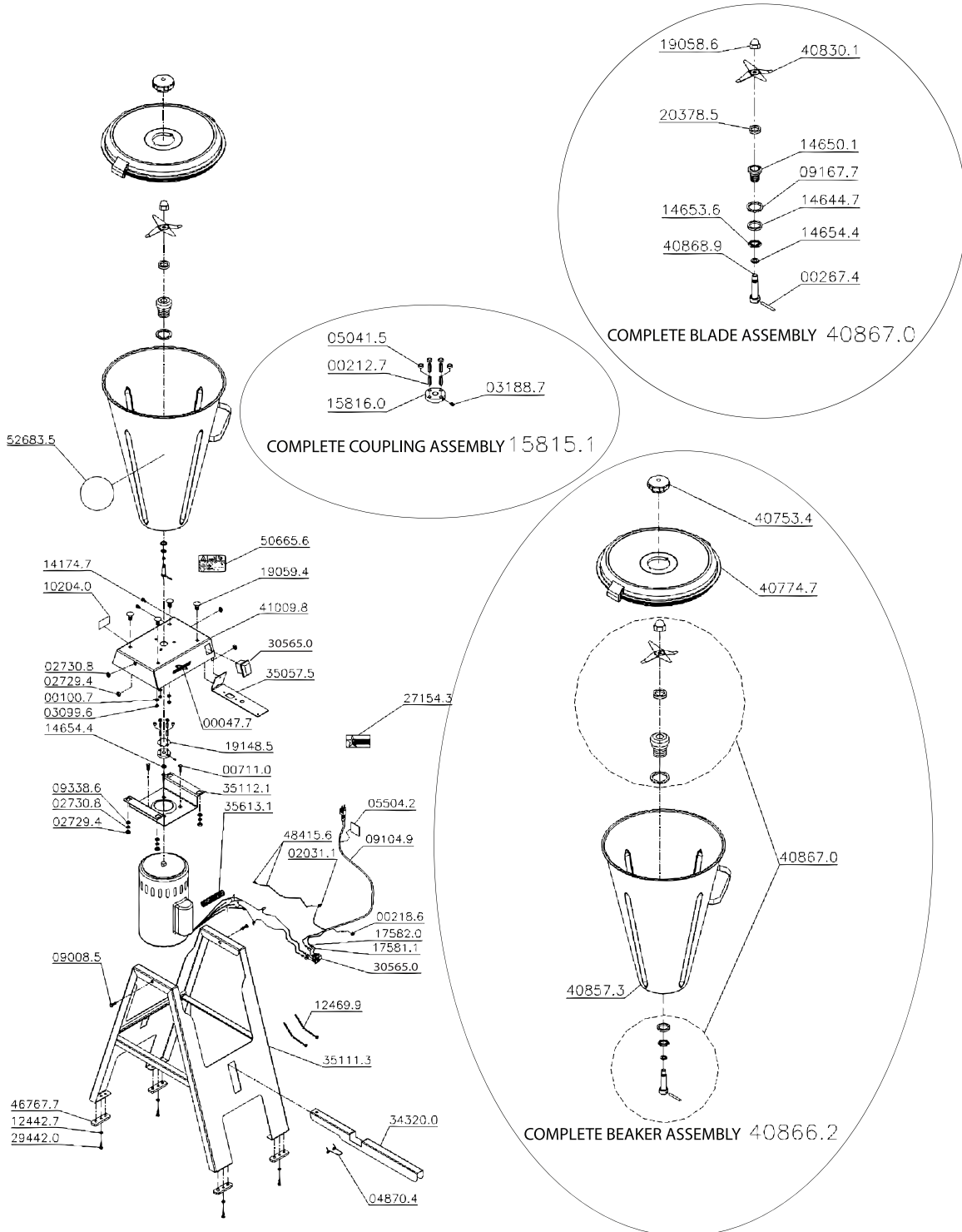

# Parts Breakdown

## Model BL-BR-0015 37969

Item No.	Description	Position	Item No.	Description	Position	Item No.	Description	Position
38109	Skymesen Logo Small for LAR-15PMB	00047.7	30045	Bracer K22-LM(T-80I) for LAR-15PMB	12469.9	38299	Pedal (Grey) for LAR-15PMB	34320.0
30234	Washer L 1/4x1 6 ZB for LAR-15PMB	00100.7	38208	Wire Passer Molde 0922231 for LAR-15PMB	13737.5	27754	Maintenance/Cleaning Label Comm for LAR-15PMB	34686.1
38217	Elastic Pin 6x22 for LAR-15PMB	00212.7	38292	Screw M6x8 DIN 84 ZB for LAR-15PMB	14174.7	38322	Rubber Foot for LAR-15PMB	34895.3
30186	Wire Passer Molde 0922231 for LAR-15PMB	00218.6	16434	Motor 1.5HP 60HZ 110V for LAR-15PMB	14211.5	38202	Motor Support for LAR-15PMB	35057.5
16395	Lock Pin for LAR-15PMB	00267.4	38319	Distance Washer for LAR-15PMB	14644.7	79052	CS Easel Gray for LAR-15PMB	35111.3
30324	Six Sided Screw UNC 3/8 x 7/8 RTZB for LAR-15PMB	00711.0	38317	Central Bearing with Bush for LAR-15PMB	14650.1	38288	Motor Support (Grey) for LAR-15PMB	35112.1
27692	Insult Term EF-4228 for LAR-15PMB	01213.0	38314	Lower Nut M22x1.5 for LAR-15PMB	14653.6	38289	Plastic Conduit for LAR-15PMB	35613.1
30350	Nylon Cover CN-4472 for LAR-15PMB	02031.1	38295	Fiber Washer 20x13x0.7 for LAR-15PMB	14654.4	79055	Sleeve for LAR-15PMB	39691.5
38557	Screw Nut DIN 934 ZB for LAR-15PMB	02729.4	38312	Nut 10x1.25 for LAR-15PMB	14660.9	70157	Cap Cover for LAR-15PMB	40753.4
27693	Washer L.A8.4 ZB for LAR-15PMB	02730.8	38308	Complete Clutch for LAR-15PMB	15815.1	38215	Lid for LAR-15PMB	40774.7
38180	Screw Nut M6 DIN 934 ZB for LAR-15PMB	03099.6	38316	Cover for LAR-15PMB	17456.4	27845	Blade for LAR-15PMB	40830.1
38320	Nut M5 DIN 934 ZB for LAR-15PMB	03145.3	79037	Positive Terminal Lock for LAR-15PMB	17581.1	38214	CS Cup for LAR-15PMB	40857.3
27695	Allen Screw M6x8 for LAR-15PMB	03188.7	30050	Terminal Cover for LAR-15PMB	17582.0	38213	Complete Bearing Set with Beaker for LAR-15PMB	40866.2
24023	The Spring Rocker for LAR-15PMB	04870.4	27709	Screw M8x16 DIN 933 ZB for LAR-15PMB	19059.4	79061	Bearing Complete for LAR-15PMB	40867.0
38220	Distanc. Washer for LAR-15PMB	05041.5	79041	Baffle for LAR-15PMB	19148.5	38315	Center Axis for LAR-15PMB	40868.9
38297	PFS M8x40 DIN 933 ZB for LAR-15PMB	09008.5	38087	Washer L.A5.3 DIN 125 INOX for LAR-15PMB	20194.4	38284	CS Tilting Base Support (Grey) for LAR-15PMB	41009.8
38171	Cord 3x1 5mm2 with PGRE 2PC1PR for LAR-15PMB	09104.9	38313	Seal V-Ring 16.5x10.5x5.5 for LAR-15PMB	20378.5	38300	PE Rectangular (MOL 483753) for LAR-15PMB	46767.7
38318	Bearing Seal Ring for LAR-15PMB	09167.7	27720	Omcan Logo (Machines) for LAR-15PMB	27154.3	79065	CB. Ground 1.5mm 2x420mm for LAR-15PMB	48415.6
38296	Washer L.A10.5 ZB for LAR-15PMB	09338.6	38302	PFS Auto BROCC 4.2x13 ZB for LAR-15PMB	29442.0	78551	Cleaning Maintenance Label for LAR-15PMB	50665.6
16419	Washer L.A6 4 125 INOX for LAR-15PMB	12442.7	45648	On/Off Switch Black C/PROT.30223 M2FT-2FE3V for LAR-15PMB	30565.0	79067	Pedal Separator for LAR-15PMB	51024.6

# Parts Breakdown

Model **BL-BR-0025** 31502

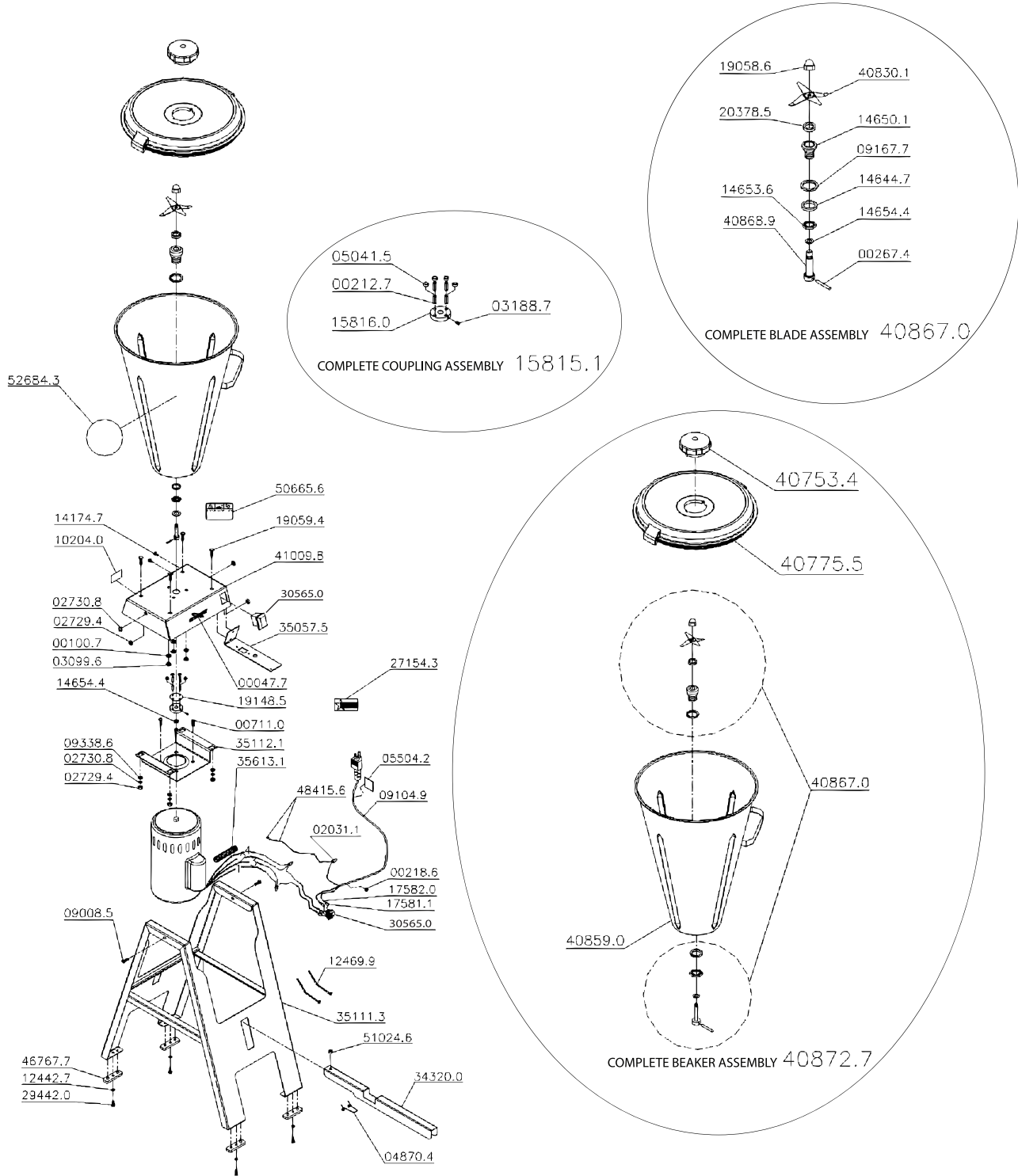

# Parts Breakdown

## Model BL-BR-0025 31502

Item No.	Description	Position	Item No.	Description	Position	Item No.	Description	Position
38109	Skymesen Logo Small for LAR-25PMB	00047.7	30045	Bracer K22-LM(T-80I) for LAR-25PMB	12469.9	38299	Pedal (Grey) for LAR-25PMB	34320.0
30234	Washer L 1/4x1 6 ZB for LAR-25PMB	00100.7	38208	Wire Passer Molde 0922231 for LAR-25PMB	13737.5	27754	Maintenance/Cleaning Label Comm for LAR-25PMB	34686.1
38217	Elastic Pin 6x22 for LAR-25PMB	00212.7	38292	Screw M6x8 DIN 84 ZB for LAR-25PMB	14174.7	38322	Rubber Foot for LAR-25PMB	34895.3
30186	Wire Passer Molde 0922231 for LAR-25PMB	00218.6	16434	Motor 1.5HP 60HZ 110V for LAR-25PMB	14211.5	38202	Motor Support for LAR-25PMB	35057.5
16395	Lock Pin for LAR-25PMB	00267.4	38319	Distance Washer for LAR-25PMB	14644.7	79052	CS Easel Grey for LAR-25PMB	35111.3
30324	Six Sided Screw UNC 3/8x7/8 RTZB for LAR-25PMB	00711.0	38317	Central Bearing with Bush for LAR-25PMB	14650.1	38288	Motor Support (Grey) for LAR-25PMB	35112.1
27692	Insult Term EF-4228 for LAR-25PMB	01213.0	38314	Lower Nut M22x1.5 for LAR-25PMB	14653.6	38289	Plastic Conduit for LAR-25PMB	35613.1
30350	Nylon Cover CN-4472 for LAR-25PMB	02031.1	38295	Fiber Washer 20x13x0.7 for LAR-25PMB	14654.4	79055	Sleeve for LAR-25PMB	39691.5
38557	Screw Nut DIN 934 ZB for LAR-25PMB	02729.4	38312	Nut 10x1.25 for LAR-25PMB	14660.9	70157	Cap Cover for LAR-25PMB	40753.4
27693	Washer L.A8.4 ZB for LAR-25PMB	02730.8	38308	Complete Clutch for LAR-25PMB	15815.1	65872	Cover 25 (FE006-112) for LAR-25PMB	40775.5
38180	Screw Nut M6 DIN 934 ZB for LAR-25PMB	03099.6	38316	Cover for LAR-25PMB	17456.4	27845	Blade for LAR-25PMB	40830.1
38320	Nut M5 DIN 934 ZB for LAR-25PMB	03145.3	79037	Positive Terminal Lock for LAR-25PMB	17581.1	38304	Cup Set for LAR-25PMB	40859.0
27695	Allen Screw M6x8 for LAR-25PMB	03188.7	30050	Terminal Cover for LAR-25PMB	17582.0	79061	Bearing Complete for LAR-25PMB	40867.0
24023	Spring Rocker for LAR-25PMB	04870.4	27709	Screw M8x16 DIN 933 ZB for LAR-25PMB	19059.4	38315	Center Axis for LAR-25PMB	40868.9
38220	Distanc. Washer for LAR-25PMB	05041.5	79041	Baffle for LAR-25PMB	19148.5	38303	Complete Cup for LAR-25PMB	40872.7
38297	PFS M8x40 DIN 933 ZB for LAR-25PMB	09008.5	38087	Washer L.A5.3 DIN 125 INOX for LAR-25PMB	20194.4	38284	CS Tilting Base Support (Grey) for LAR-25PMB	41009.8
38171	Cord 3x1 5mm2 with PGRE 2PC1PR for LAR-25PMB	09104.9	38313	Seal V-Ring 16.5x10.5x5.5 for LAR-25PMB	20378.5	38300	PE Rectangular (MOL 483753) for LAR-25PMB	46767.7
38318	Bearing Seal Ring for LAR-25PMB	09167.7	27720	Omcan Logo (Machines) for LAR-25PMB	27154.3	79065	CB. Ground 1.5mm 2x420mm for LAR-25PMB	48415.6
38296	Washer L.A10.5 ZB for LAR-25PMB	09338.6	38302	PFS Auto Broc 4.2x13 ZB for LAR-25PMB	29442.0	78551	Cleaning Maintenance Label for LAR-25PMB	50665.6
16419	Washer L.A6 4 125 Inox for LAR-25PMB	12442.7	45648	On/Off Switch Black C/PROT.30223 M2FT-2FE3V for LAR-25PMB	30565.0	79067	Pedal Separator for LAR-25PMB	51024.6

# Electrical Schematics

Model **BL-BR-0015** 37969

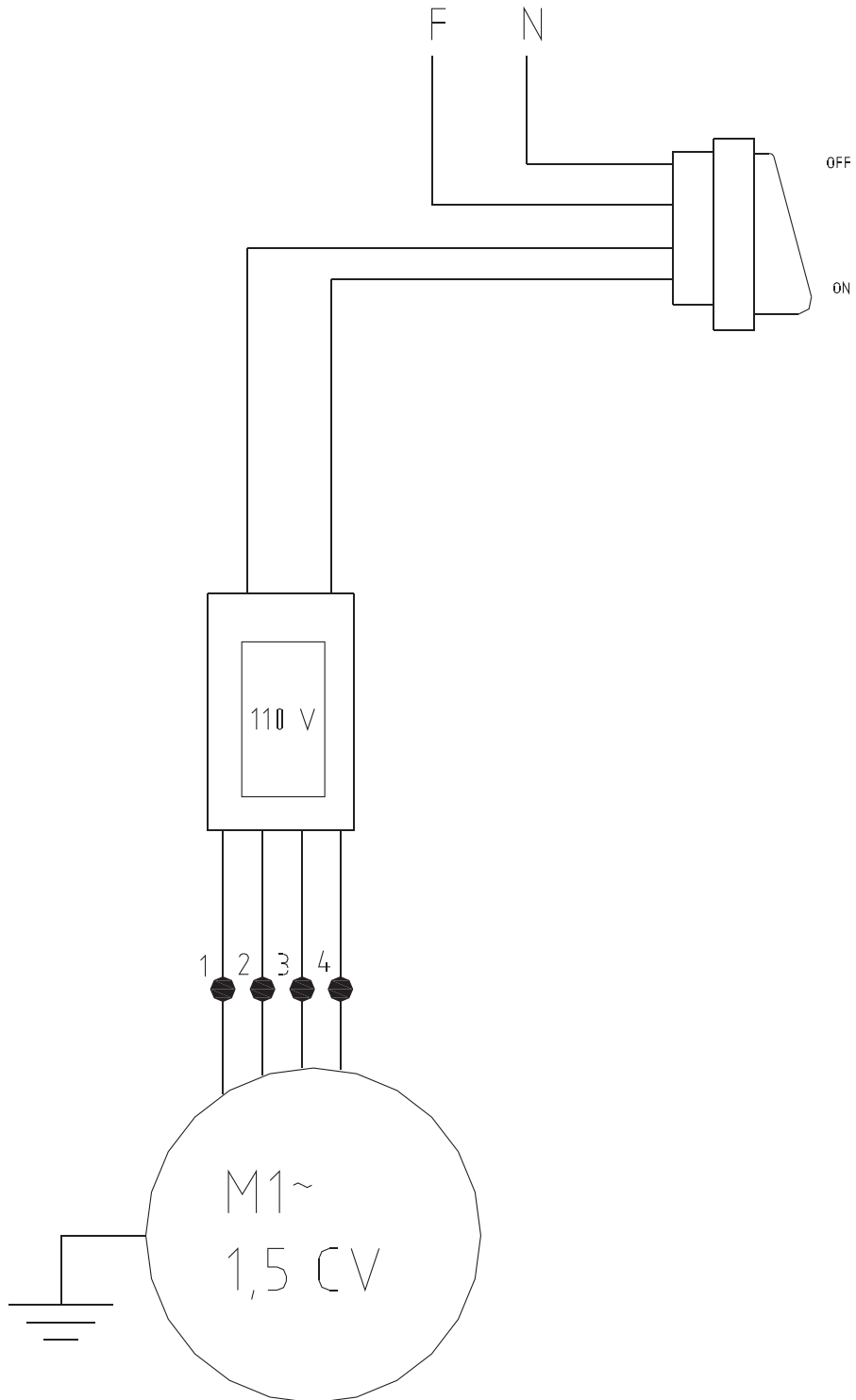

# Electrical Schematics

Model **BL-BR-0025** 31502

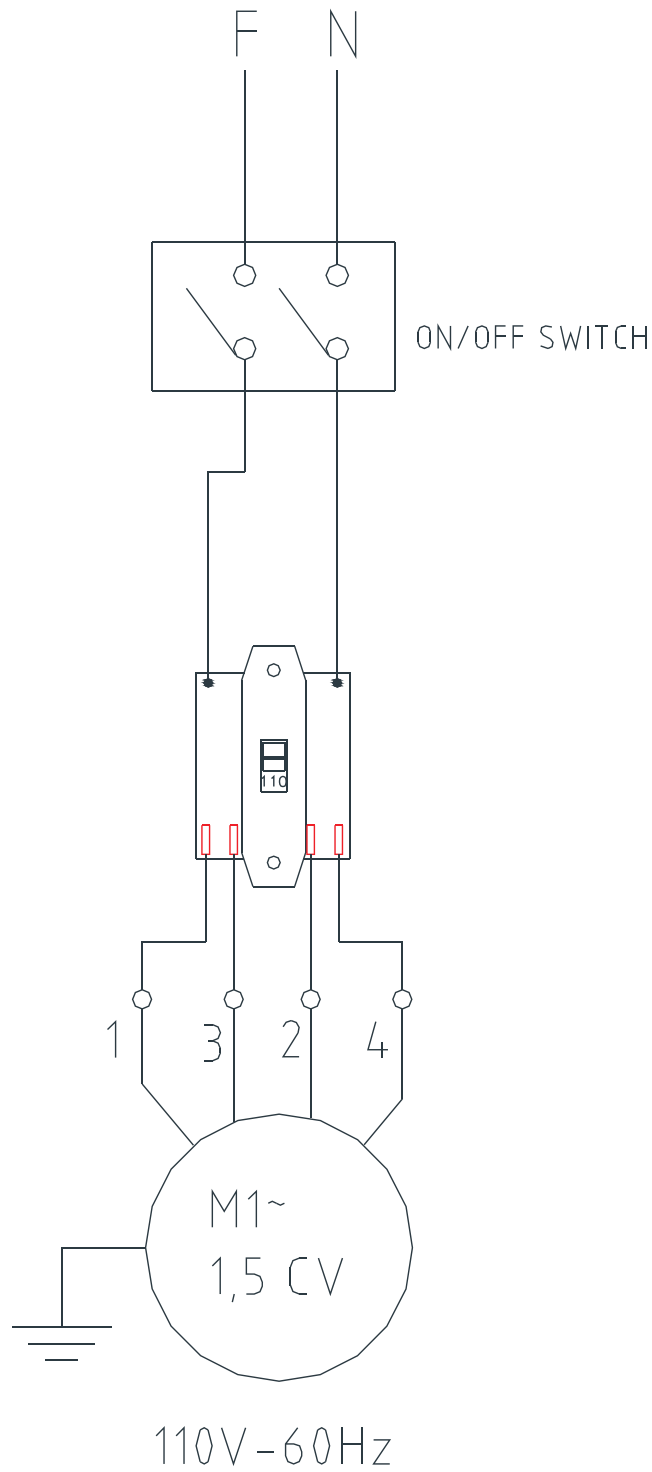





# Warranty Registration

Thank you for purchasing an Omcan product. To register your warranty for this product, complete the information below, tear off the card at the perforation and then send to the address specified below. You can also register online by visiting:

Merci d'avoir acheté un produit Omcan. Pour enregistrer votre garantie pour ce produit, complétez les informations ci-dessous, détachez la carte au niveau de la perforation, puis l'envoyer à l'adresse spécifiée ci-dessous. Vous pouvez également vous inscrire en ligne en visitant:

Gracias por comprar un producto Omcan usted. Para registrar su garantía para este producto, complete la información a continuación, cortar la tarjeta en la perforación y luego enviarlo a la dirección indicada a continuación. También puede registrarse en línea en:

[www.omcan.com/warrantyregistration.html](http://www.omcan.com/warrantyregistration.html)

For mailing in Canada

Pour postale au Canada

Por correo en Canadá

**OMCAN**

PRODUCT WARRANTY REGISTRATION

3115 Pepper Mill Court,

Mississauga, Ontario

Canada, L5L 4X5

For mailing in the US

Pour diffusion aux États-Unis

Por correo en los EE.UU.

**OMCAN**

PRODUCT WARRANTY REGISTRATION

4450 Witmer Industrial Estates, Unit 4,

Niagara Falls, New York

USA, 14305

*or email to: [service@omcan.com](mailto:service@omcan.com)*



Purchaser's Information

Name: \_\_\_\_\_

Address: \_\_\_\_\_

City: \_\_\_\_\_ Province or State: \_\_\_\_\_ Postal or Zip: \_\_\_\_\_

Country: \_\_\_\_\_

Dealer from which Purchased: \_\_\_\_\_

Dealer City: \_\_\_\_\_ Dealer Province or State: \_\_\_\_\_

Invoice: \_\_\_\_\_

Model Name: \_\_\_\_\_ Model Number: \_\_\_\_\_

Machine Description: \_\_\_\_\_

Date of Purchase (MM/DD/YYYY): \_\_\_\_\_

Would you like to extend the warranty?  Yes  No

Company Name: \_\_\_\_\_

Telephone: \_\_\_\_\_

Email Address: \_\_\_\_\_

Type of Company:

Restaurant  Bakery  Deli

Butcher  Supermarket  Caterer

Institution (*specify*): \_\_\_\_\_

Other (*specify*): \_\_\_\_\_

Serial Number: \_\_\_\_\_

Date of Installation (MM/DD/YYYY): \_\_\_\_\_

**Thank you for choosing Omcan | Merci d'avoir choisi Omcan | Gracias por elegir Omcan**



Since 1951 Omcan has grown to become a leading distributor of equipment and supplies to the North American food service industry. Our success over these many years can be attributed to our commitment to strengthen and develop new and existing relationships with our valued customers and manufacturers. Today with partners in North America, Europe, Asia and South America, we continually work to improve and grow the company. We strive to offer customers exceptional value through our qualified local sales and service representatives who provide convenient access to over 3,500 globally sourced products.

---

Depuis 1951 Omcan a grandi pour devenir un des “leaders” de la distribution des équipements et matériel pour l’industrie des services alimentaires en Amérique du Nord. Notre succès au cours de ces nombreuses années peut être attribué à notre engagement à renforcer et à développer de nouvelles et existantes relations avec nos clients et les fabricants de valeur. Aujourd’hui avec des partenaires en Amérique du Nord, Europe, Asie et Amérique du Sud, nous travaillons continuellement à améliorer et développer l’entreprise. Nous nous efforçons d’offrir à nos clients une valeur exceptionnelle grâce à nos ventes locales qualifiées et des représentants de service qui offrent un accès facile à plus de 3500 produits provenant du monde entier.

---

Desde 1951 Omcan ha crecido hasta convertirse en un líder en la distribución de equipos y suministros de alimentos en América del Norte industria de servicios. Nuestro éxito en estos años se puede atribuir a nuestro compromiso de fortalecer y desarrollar nuevas relaciones existentes con nuestros valiosos clientes y fabricantes. Hoy con socios de América del Norte, Europa, Asia y América del Sur, que trabajan continuamente para mejorar y crecer la empresa. Nos esforzamos por ofrecer a nuestros clientes valor excepcional a través de nuestro local de ventas y representantes de los servicios que proporcionan un fácil acceso a más de 3,500 productos con origen a nivel mundial.

