

# Parts Breakdown

Model CE-CN-G15M 43737

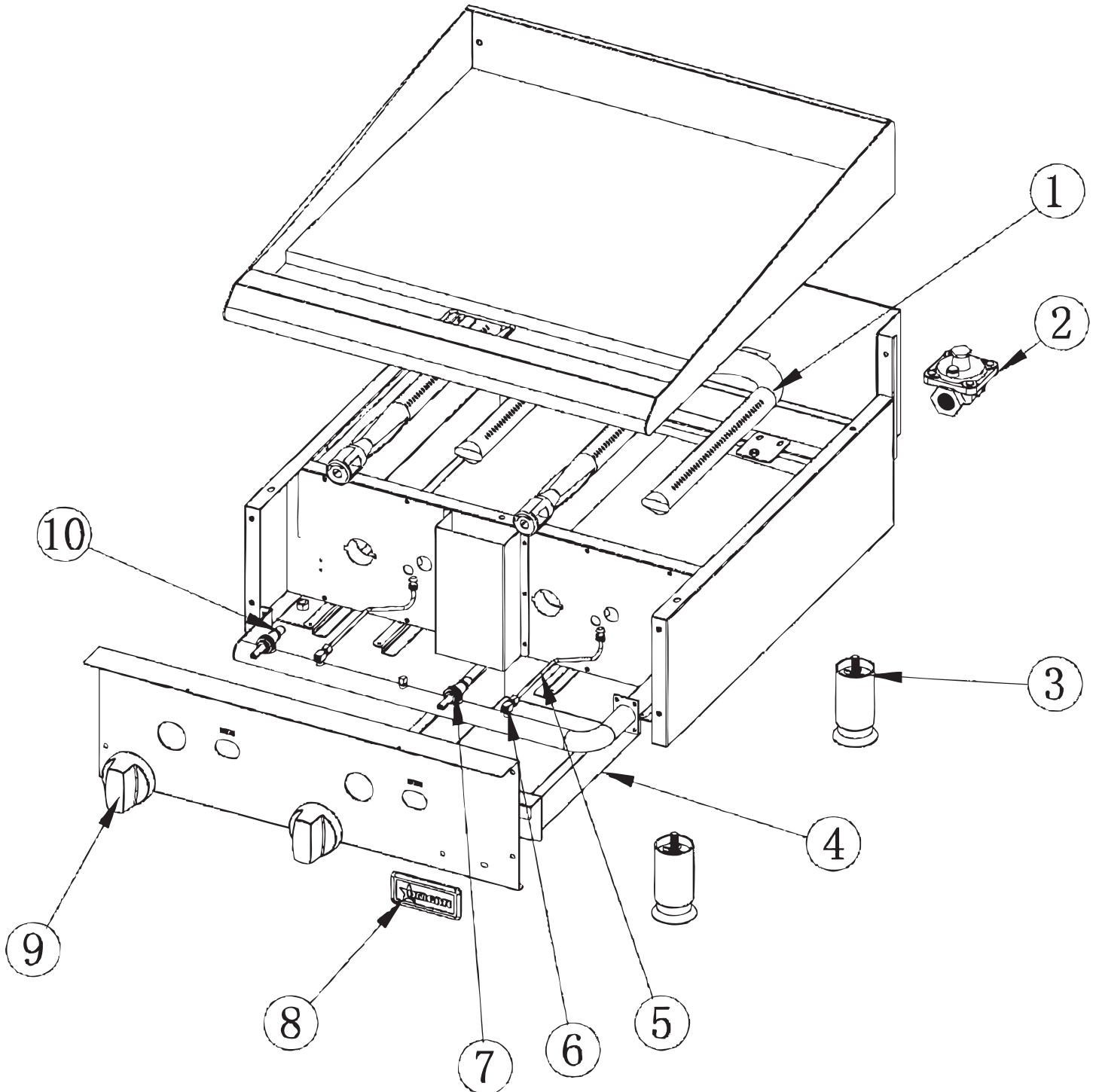



# Parts Breakdown

---

## Model CE-CN-G15M 43737

Item No.	Description	Position	Item No.	Description	Position	Item No.	Description	Position
73092	Burner for 43737	1	73088	Pilot Pipe for 43737	5	43489	Red Dial for Manual Control for 43737	9
72407	Regulator for 43737	2	73089	Pilot Valve for 43737	6	72416	Orifice 41 # NAT for 43737	10
72410	Foot for 43737	3	73090	Valve for 43737	7	42968	Conversion Kits for 43737	11
72412	Tray for 43737	4	43313	Name Badge for Omcan for 43737	8			