

Parts Breakdown

Model CE-CN-G48M 43732

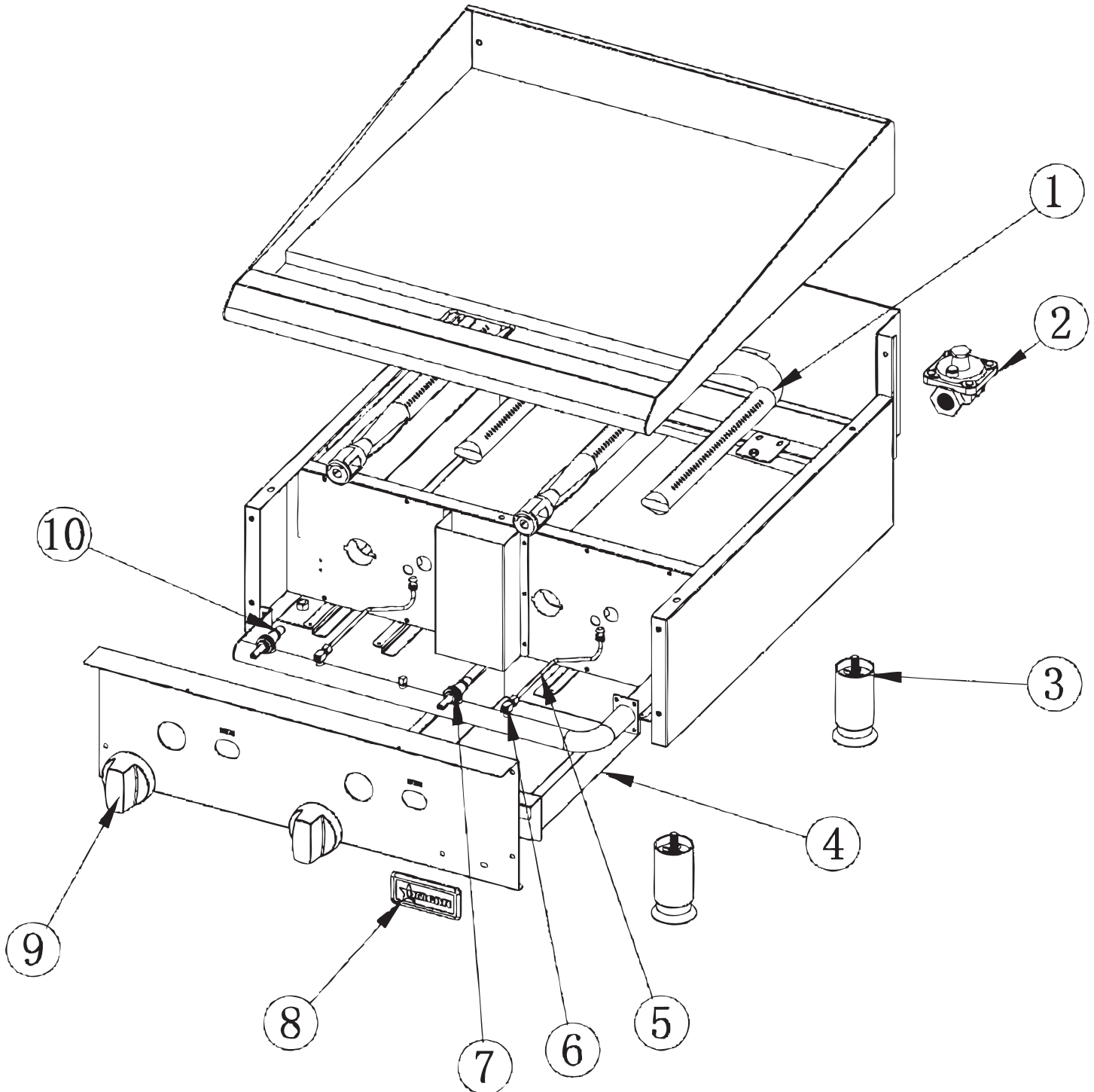



Parts Breakdown

Model CE-CN-G48M 43732

Item No.	Description	Position	Item No.	Description	Position	Item No.	Description	Position
73092	Burner for 43732	1	73088	Pilot Pipe for 43732	5	43489	Red Dial for Manual Control for 43732	9
72407	Regulator for 43732	2	73089	Pilot Valve for 43732	6	72416	Orifice 41 # NAT for 43732	10
72410	Foot for 43732	3	73090	Valve for 43732	7	42971	Conversion Kits for 43732	11
72412	Tray for 43732	4	43313	Name Badge for Omcan for 43732	8			