

# Parts Breakdown

Model CE-CN-G48TPF 43019

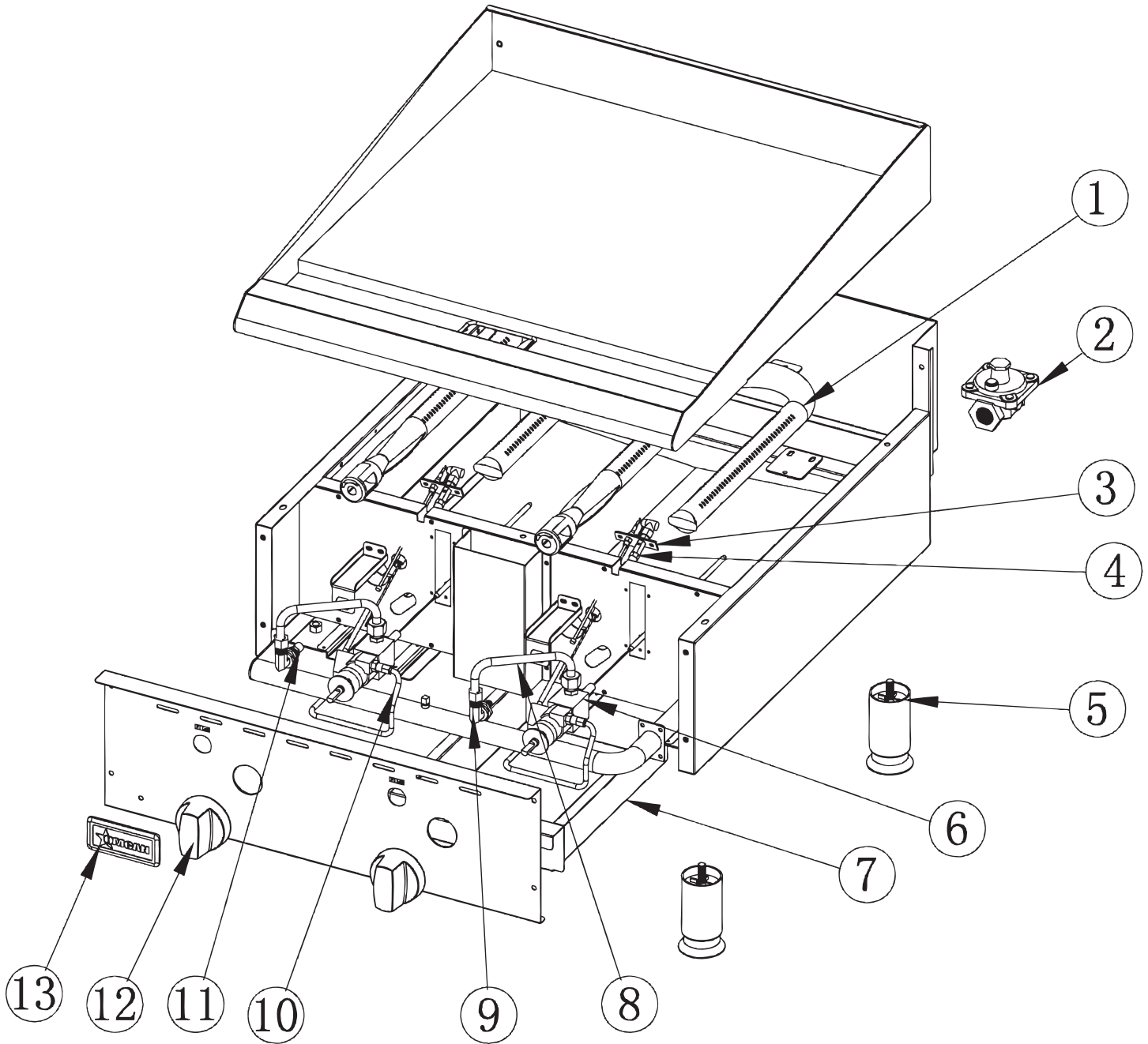



# Parts Breakdown

---

## Model CE-CN-G48TPF 43019

Item No.	Description	Position	Item No.	Description	Position	Item No.	Description	Position
73092	Burner for 43019	1	72411	Thermostat Valve for 43019	6	72416	Orifice 41 # NAT for 43019	11
72407	Regulator for 43019	2	72412	Tray for 43019	7	43315	Red Dial for Thermostat Control for 43019	12
72408	Flame Device System (Exclude Injector) for 43019	3	72413	Main Pipe Assy. for 43019	8	43313	Name Badge for Omcan for 43019	13
72409	ODS Injector-0.45 NAT for 43019	4	63534	Orifice Connection (Front) for 43019	9	43308	Conversion Kits for 43019	14
72410	Foot for 43019	5	72415	Pilot Pipe Assy. for 43019	10			