

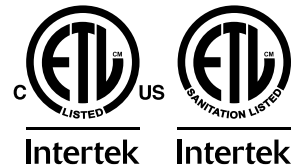

**Refrigerated Cabinets**  
*Models RE-CN-0036-C, 0052-C, 0072-C*  
*Items 50070, 50071, 50072*  
**Instruction Manual**



*Revised - 08/31/2022*



Toll Free: 1-800-465-0234  
Fax: 905-607-0234  
Email: [service@omcan.com](mailto:service@omcan.com)  
[www.omcan.com](http://www.omcan.com)

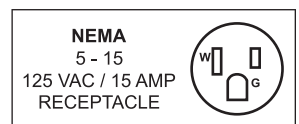

# ***Table of Contents***

Model RE-CN-0036-C / Model RE-CN-0052-C / Model RE-CN-0072-C

---

<b>Section</b>	<b>Page</b>
Disclaimer -----	3
General Information -----	4 - 5
Safety and Warranty -----	5 - 7
Technical Specifications -----	7
Installation -----	7 - 11
Operation -----	11
Maintenance -----	11 - 13
Troubleshooting -----	13 - 14
Parts Breakdown -----	15 - 20
Electrical Schematics -----	21 - 23
Notes -----	24 - 26
Warranty Registration -----	27

## *Disclaimer*

---

***OMCAN IS NOT RESPONSIBLE FOR ANY DAMAGES DUE TO WATER LEAKS. WARRANTY FOR WATER LEAKS IS VOID IF THE AMBIENT ROOM TEMPERATURE EXCEEDS 75°F AND 55% RELATIVE HUMIDITY, AND THE APPLIANCE DRAIN IS NOT CONNECTED DIRECTLY TO A FLOOR DRAIN.***

# General Information

---

Omcan Manufacturing and Distributing Company Inc., Food Machinery of America, Inc. dba Omcan and Omcan Inc. are not responsible for any harm or injury caused due to any person's improper or negligent use of this equipment. The product shall only be operated by someone over the age of 18, of sound mind, and not under the influence of any drugs or alcohol, who has been trained in the correct operation of this machine, and is wearing authorized, proper safety clothing. Any modification to the machine voids any warranty, and may cause harm to individuals using the machine or in the vicinity of the machine while in operation.

## CHECK PACKAGE UPON ARRIVAL

Upon receipt of [an](#) Omcan shipment please inspect for external damage. If no damage is evident on the external packaging, open carton to ensure all ordered items are within the box, and there is no concealed damage to the machine. If the package has suffered rough handling, bumps or damage (visible or concealed), please note it on the bill of lading before accepting the delivery and contact Omcan within 24 hours, so we may initiate a claim with the carrier. A detailed report on the extent of the damage caused to the machine must be filled out within three days, from the delivery date shown in the shipping documents. Omcan has no recourse for damaged products that were shipped collect or third party.

**Before operating any equipment, always read and familiarize yourself with all operation and safety instructions.**

Omcan would like to thank you for purchasing this machine. It's of the utmost importance to save these instructions for future reference. Also save the original box and packaging for shipping the equipment if servicing or returning of the machine is required.

---

Omcan Fabrication et distribution Compañie Limité et Food Machinery d'Amérique, dba Omcan et Omcan Inc. ne sont pas responsables de tout dommage ou blessure causé du fait que toute personne ait utilisé cet équipement de façon irrégulière. Le produit ne doit être exploité que par quelqu'un de plus de 18 ans, saine d'esprit, et pas sous l'influence d'une drogue ou d'alcool, qui a été formé pour utiliser cette machine correctement, et est vêtu de vêtements de sécurité approprié. Toute modification de la machine annule toute garantie, et peut causer un préjudice à des personnes utilisant la machine ou des personnes à proximité de la machine pendant son fonctionnement.

## VÉRIFIEZ LE COLIS DÈS RÉCEPTION

Dès réception d'une expédition d'Omcan veuillez inspecter pour dommages externes. Si aucun dommage n'est visible sur l'emballage externe, ouvrez le carton afin de s'assurer que tous les éléments commandés sont dans la boîte, et il n'y a aucun dommage dissimulé à la machine. Si le colis n'a subi aucune mauvaises manipulations, de bosses ou de dommages (visible ou cachée), notez-le sur le bond de livraison avant d'accepter la livraison et contactez Omcan dans les 24 heures qui suivent, pour que nous puissions engager une réclamation auprès du transporteur. Un rapport détaillé sur l'étendue des dommages causés à la machine doit être rempli dans un délai de trois jours, à compter de la date de livraison indiquée dans les documents d'expédition. Omcan n'a aucun droit de recours pour les produits endommagés qui ont été expédiés ou cueilli par un tiers transporteur.



# General Information

---

Avant d'utiliser n'importe quel équipement, toujours lire et vous familiariser avec toutes les opérations et les consignes de sécurité.

Omcan voudrais vous remercier d'avoir choisi cette machine. Il est primordial de conserver ces instructions pour une référence ultérieure. Également conservez la boîte originale et l'emballage pour l'expédition de l'équipement si l'entretien ou le retour de la machine est nécessaire.

---

Omcan Empresa De Fabricacion Y Distribucion Inc. Y Maquinaria De Alimentos De America, Inc. dba Omcan y Omcan Inc. no son responsables de ningun daño o perjuicio causado por cualquier persona inadecuada o el uso descuidado de este equipo. El producto solo podra ser operado por una persona mayor de 18 años, en su sano juicio y no bajo alguna influencia de droga o alcohol, y que este ha sido entrenado en el correcto funcionamiento de esta máquina, y ésta usando ropa apropiada y autorizada. Cualquier modificación a la máquina **anula** la garantía y puede causar daños a las personas usando la máquina mientras esta en el funcionamiento.

## REVISE EL PAQUETE A SU LLEGADA

Tras la recepcion de un envio Omcan favor inspeccionar daños externos. Si no hay daños evidentes en el empaque exterior, Habra el carton para asegurarse que todos los articulos solicitados estén dentro de la caja y no encuentre daños ocultos en la máquina. Si el paquete ha sufrido un manejo de poco cuidado, golpes o daños (visible o oculto) por favor anote en la factura antes de aceptar la entrega y contacte Omcan dentro de las 24 horas, de modo que podamos iniciar una reclamación con la compañía. Un informe detallado sobre los daños causados a la máquina debe ser llenado en el plazo de tres días, desde la fecha de entrega que se muestra en los documentos de envío. Omcan no tiene ningun recurso por productos dañados que se enviaron a recoger por terceros.

Antes de utilizar cualquier equipo, siempre lea y familiarizarse con todas las instrucciones de funcionamiento y seguridad.

Omcan le gustaría darle las gracias por la compra de esta máquina. Es de la mayor importancia para salvar estas instrucciones para futuras consultas. Además, guarda la caja original y el embalaje para el envío del equipo si servicio técnico o devolución de la máquina que se requiere.

# Safety and Warranty

---

**WARNING:** Use this appliance for its intended purpose as described in this Owner Manual. Please pay close attention to the safety notices below. Disregarding these notices may lead to serious injury and/or damage to the unit.

## ATTENTION

- This refrigerator must be properly installed and located in accordance with the installation instructions

# Safety and Warranty

---

before it is used.

- Do not allow children to climb, stand or hang on the shelves in the refrigerator. They could damage the refrigerator and seriously injure themselves.
- Unplug the refrigerator before cleaning and making repairs.
- To minimize shock and fire hazards, be sure not to overload outlet. Please designate one outlet for your unit.
- Do not use extension cords.
- Do not put your hands under the unit when the units is required to be moved.
- When the unit is not in use for a long period o time, please unplug the unit from the outlet.
- After unplugging the unit, wait at least 10 minutes before re-plugging it. Failure to do so could cause damage to the compressor.

## PROPER GROUNDING REQUIRED

- To minimize shock and fire hazards, make sure that the unit is properly grounded.

## PROHIBITION

- Do not attempt to remove or repair any component unless instructed by factory.
- Make sure that the unit is not resting on or against the electrical cord and plug.
- To minimize personal injury, do not hang on the drawers.
- Do not store any flammable and explosive gas or liquids inside the unit.
- Do not attempt to alter or tamper with the electrical cord.

## APPLIANCE DISPOSAL

When recycling appliance please make sure that the refrigerants are handled according to local and national codes, requirements and regulations.

## REFRIGERANT DISPOSAL

Your old refrigerator may have a cooling system that uses “Ozone Depleting” chemicals. If you are throwing away your old refrigerator, make sure the refrigerant is removed for proper disposal by a qualified service technician. If you intentionally release any refrigerants you can be subject to fines and imprisonment under provisions of the environmental regulations.

**RESIDENTIAL USERS: Vendor assumes no liability for parts or labor coverage for component failure or other damages resulting from installation in non-commercial or residential applications. The right is reserved to deny shipment for residential usage; if this occurs, you will be notified as soon as possible.**

## 1 YEAR PARTS AND LABOUR WARRANTY

Within the warranty period, contact Omcan Inc. at 1-800-465-0234 to schedule [an](#) Omcan authorized service technician to repair the equipment locally.

**Unauthorized maintenance will void the warranty. Warranty covers electrical and part failures, not improper use.**



# Safety and Warranty

Please see <https://omcan.com/disclaimer> for complete info.

## WARNING:

The packaging components are classified as normal solid urban waste and can therefore be disposed of without difficulty.

In any case, for suitable recycling, we suggest disposing of the products separately (differentiated waste) according to the current norms.

**DO NOT DISCARD ANY PACKAGING MATERIALS IN THE ENVIRONMENT!**

# Technical Specifications

Model	RE-CN-0036-C	RE-CN-0052-C	RE-CN-0072-C
Net Volume	821 L / 29 cu. ft.	960 L / 34 cu. ft.	1341 L / 47 cu. ft.
Number of Drawers	2		4
Shelf Capacity (Each Drawer)	1 - Full Size GN Pan and 3 - 1/6 Size GN Pans	3 - Full Size GN Pans	8 - Full Size GN Pans
Temperature Range	0.5 - 5°C / 33 - 41°F		
Max Ambient Temp Rating	24°C / 75°F		
Horsepower	1/6 HP	1/4 HP	1/3 HP
Electrical	110V / 60Hz / 1Ph		
Rated Current	2.1A	2.9A	
Refrigerant	R290		
Cord Length	7.4 FT. / 2.25M		
Dimensions	36" x 32" x 25" 914 x 813 x 635mm	52" x 32" x 25" 1321 x 813 x 635mm	72" x 32" x 25" 1829 x 813 x 635mm
Weight	154 lbs. / 70 kgs.	209 lbs. / 95 kgs.	330 lbs. / 150 kgs.
Item Number	50070	50071	50072

# Installation

## IMPORTANT!!! PLEASE READ BEFORE INSTALLATION

- If the unit has recently been transported, please let unit stand still for a minimum of 24 hours before

# Installation

---

plugging it in.

- Make sure that the unit drops down to desired temperature before loading the unit with product.
- Make sure that there is proper ventilation around the unit in the area where it will operate.
- Make sure all accessories are installed (i.e. poly pans, drawers, casters) before plugging the unit in.
- Please read through the Operation / Owners Manual in its entirety.

## UNCRATING

### TOOLS REQUIRED

- Adjustable Wrench.
- Phillips Screwdriver.
- Level.

The following procedure is recommended for uncrating the unit:

- Remove the outer packaging, (cardboard and bubbles or Styrofoam corners and clear plastic). Inspect for concealed damage. Again, immediately file a claim with the freight carrier if there is damage.
- Move your unit as close to the final location as possible before removing the wooden skid.

## CABINET LOCATION GUIDELINES

### INSTALL THE UNIT ON STRONG AND LEVELED SURFACES

- Unit may make unpleasant noises if surface is uneven.
- Unit may malfunction if surface is uneven.

### INSTALL THE UNIT IN **AN** INDOOR, WELL-VENTILATED AREA

- Unit performs more efficiently in a well-ventilated area.
- For best performance, please maintain clearance of 3" on the back of the unit.
- Outdoor use may cause decreased efficiency and damage to the unit.

### AVOID INSTALLATION IN A HIGH HUMIDITY AND/OR DUSTY AREA

- Humidity could cause unit to rust and decrease efficiency of the unit.
- Dust collected on condenser coil will cause unit to malfunction. Clean the condenser at least once a month with a brush or clean cloth.
- Malfunction due to dirty condenser will void warranty.

### SELECT A LOCATION AWAY FROM HEAT AND MOISTURE-GENERATING EQUIPMENT

- High ambient temperature will cause the compressor to overwork, leading to higher energy bills and gradual breakdown of the unit.
- Malfunction due to high ambient temperature will void warranty

## ELECTRIC INSTALLATION & SAFETY

### INFORMATION

- If the supply cord is damaged, it must be replaced by a special cord or assembly available from the manufacturer or its service agent.

# Installation

- Lamps must be replaced by identical lamps only.

## ELECTRICAL INSTRUCTIONS

- Before your new unit is connected to a power supply, check the incoming voltage with a voltmeter. If anything less than 100% of the rated voltage for operation is noted, correct immediately.
- All units are equipped with a service cord, and must be powered at proper operating voltage at all times. Refer to cabinet data plate for this voltage.

**WARNING:** Compressor warranties are void if compressor burns out due to low voltage.

**WARNING:** Power supply cord ground should not be removed!

**WARNING:** Do not use electrical appliances inside the food storage compartments of the appliances unless they are of the type recommended by the manufacturer.

**NOTE:** To reference wiring diagram, remove front louvered grill, wiring diagram is positioned on the inside cabinet wall.

## DRAWER REMOVAL & INSTALLATION

### REMOVAL

1. Open drawer completely. Roller clips will be in the down position.



2. While holding the sides of the drawer, use your hands to lift side track of drawer.

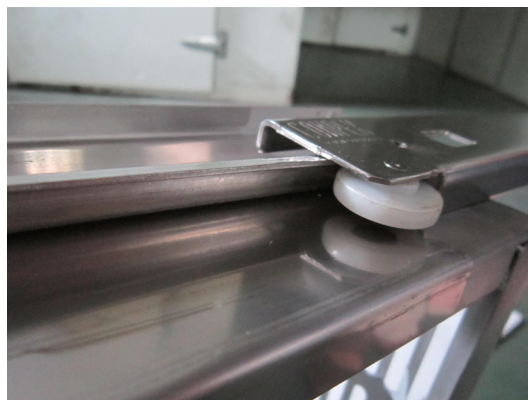

# Installation

---

3. Lift drawer and remove from channel.

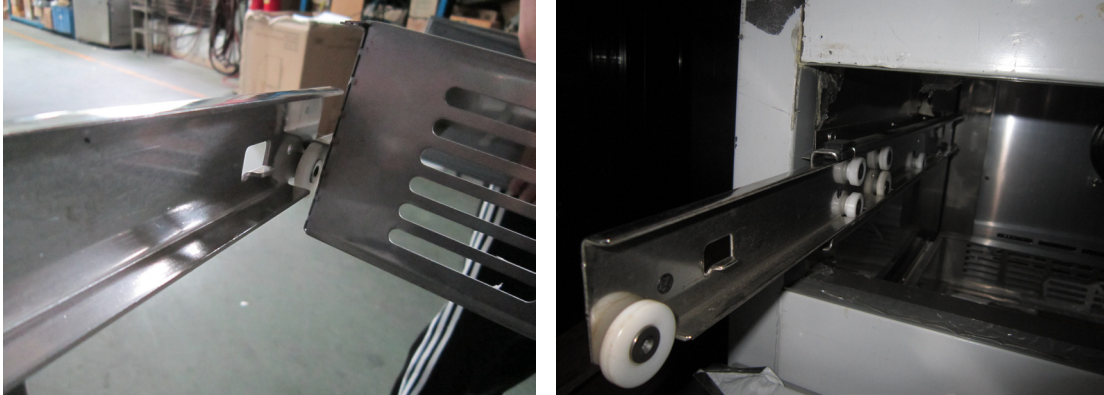

## INSTALLATION

1. Lower rear rollers into channel slots.

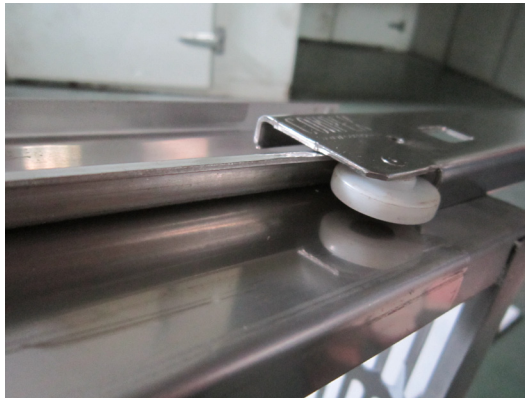

2. Make two side tracks of drawer horizontal, lower front rollers into channel.

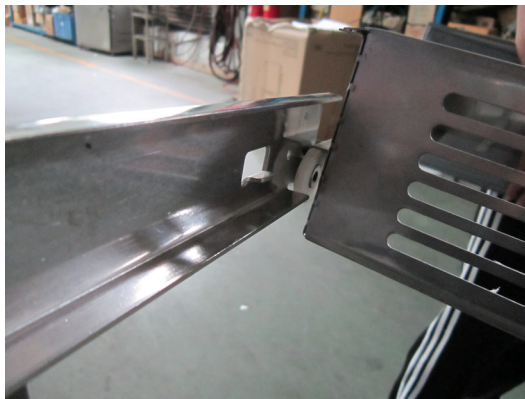

# Installation

---

3. Make sure drawer tracks are in the right position.



# Operation

---

## STARTUP

- The compressor is ready to operate. Plug in the cooler.
- DIGITAL THERMOSTAT are factory-set to give refrigerators an approximate temperature of 35°F, Allow unit to function several hours, completely cooling cabinet before changing the control setting. Temperature Control Location and Settings.
  - Electronic temperature control is located on front of unit.
- Excessive tampering with the control could lead to service difficulties. Should it ever become necessary to replace temperature control.

**NOTE:** If the unit is disconnected or shut off, wait five minutes before starting again.

**RECOMMENDATION:** Before loading product we recommend you run your unit empty for two to three days. This allows you to be sure electrical wiring and installation are correct and no shipping damage has occurred. Remember, we does not cover product loss!

# Maintenance

---

## CLEANING THE CONDENSER COIL

### REQUIRED TOOLS

- Phillips screwdriver.
- Stiff bristle brush.
- Adjustable wrench.

# Maintenance

---

- For efficient operation, it is important that the condenser surface be kept free of dust, dirt, and lint. Condensers accumulate dirt and dust and require cleaning every 30 days.
- We recommend cleaning the condenser coil and fins at least once per month.
- Clean with a commercial condenser coil cleaner, available from any kitchen equipment retailer. Brush the condenser fins from top to bottom, not side to side.
- After cleaning, straighten any bent condenser fins with a fin comb.

## CLEANING THE FAN BLADE AND MOTOR

- If necessary, clean the fan blades and motor with a soft cloth. If it is necessary to wash the fan blades, cover the fan motor to prevent moisture damage.

## CLEANING THE INTERIOR OF UNIT

- When cleaning the cabinet interior, use a solvent of warm water and mild soap.
- Do not use steel wool, caustic soap, abrasive cleaners, or bleach that may damage the stainless steel surface.
- Wash door gaskets on a regular basis, preferably weekly. Simply remove door gasket from the frame of the door, soak in warm water and soap for thirty (30) minutes, dry with soft cloth, and replace.
- Check door gaskets for proper seal after they are replaced.
- Periodically remove the shelves and pilasters from the unit and clean them with mild soap and warm water. To remove the pilasters, first remove the shelves and shelf brackets. Then, simply lift the pilaster up and out.

## STAINLESS STEEL CARE AND CLEANING

**CAUTION:** Do not use any steel wool, abrasive or chlorine based products to clean stainless steel surfaces.

### 8 STEPS THAT CAN HELP PREVENT RUST ON STAINLESS STEEL

1. Use the correct cleaning tools. Use non-abrasive tools when cleaning your stainless steel products. The stainless steel's passive layer will not be harmed by soft cloths and plastic scouring pads.
2. Clean along the polish lines. Polish lines or grain are visible on some stainless steel. Always scrub parallel to visible lines. Use a plastic scouring pad or soft cloth when grain is not visible.
3. Use alkaline, alkaline chlorinated or non-chloride containing cleaners. While many traditional cleaners are loaded with chlorides, the industry is providing an ever increasing choice of non-chloride cleaners. If unsure of chloride content contact the cleaner supplier. If present cleaner contains chlorides, ask for an alternative. Avoid cleaners containing quaternary salts as they can attack stainless steel causing pitting and rusting.
4. Water treatment. To reduce deposits, use soft water whenever possible. Installation of certain filters can be an advantage. Contact a treatment specialist about proper water treatment.
5. Maintain cleanliness of food equipment. Use cleaners at recommended strength(alkaline, alkaline chlorinated or non-chloride). Avoid buildup of hard stains by cleaning frequently.
6. When using chlorinated cleaners you must rinse and wipe dry immediately. It is better to wipe standing cleaning agents and water as soon as possible. All stainless steel equipment to air dry. Oxygen helps maintain the passivity film on stainless steel.
7. Hydrochloric acid (muriatic acid) should never be used on stainless steel.

# Maintenance

8. Regularly restore/passivate stainless steel.

# Troubleshooting

Problem	Cause	Remedy
Compressor not running.	Fuse blown or circuit breaker tripped.	Replace fuse or reset circuit breaker.
	Power cord unplugged.	Plug in power cord.
	Thermostat set too high.	Set thermostat to lower temperature.
	Cabinet in defrost cycle.	Wait for defrost cycle to finish.
Condensing unit runs for long periods of time.	Excessive amount of warm product placed in cabinet.	Allow adequate time for product to cool down.
	Prolonged door opening or door ajar.	Ensure doors are closed when not in use. Avoid opening doors for long periods of time.
	Door gasket(s) not sealing properly.	Ensure gaskets are snapped in completely. Remove gasket and wash with soap and water. Check condition of gasket and replace if necessary.
	Dirty condenser coil.	Clean the condenser coil.
	Evaporator coil iced over.	Unplug unit and allow coil to defrost. Make sure thermostat is not set too cold. Ensure that door gasket(s) are sealing properly.

# Troubleshooting

Cabinet temperature is too warm.	Thermostat set too warm.	Set thermostat to lower temperature.
	Blocking air flow.	Re-arrange product to allow for proper air flow.
	Excessive amount of warm product placed in cabinet.	Make sure there is at least four inches of clearance from evaporator.
	Fuse blown or circuit breaker tripped.	Allow adequate time for product to cool down.
	Dirty condenser coil.	Replace fuse or reset circuit breaker.
	Prolonged door opening or door ajar.	Clean the condenser coil.
	Evaporator coil iced over.	Ensure doors are closed when not in use. Avoid opening doors for long periods of time.
Cabinet is noisy.	Loose part(s).	Locate and tighten loose part(s).
	Tubing vibration.	Ensure tubing is free from contact with other tubing or components.

# Parts Breakdown

Model RE-CN-0036-C 50070

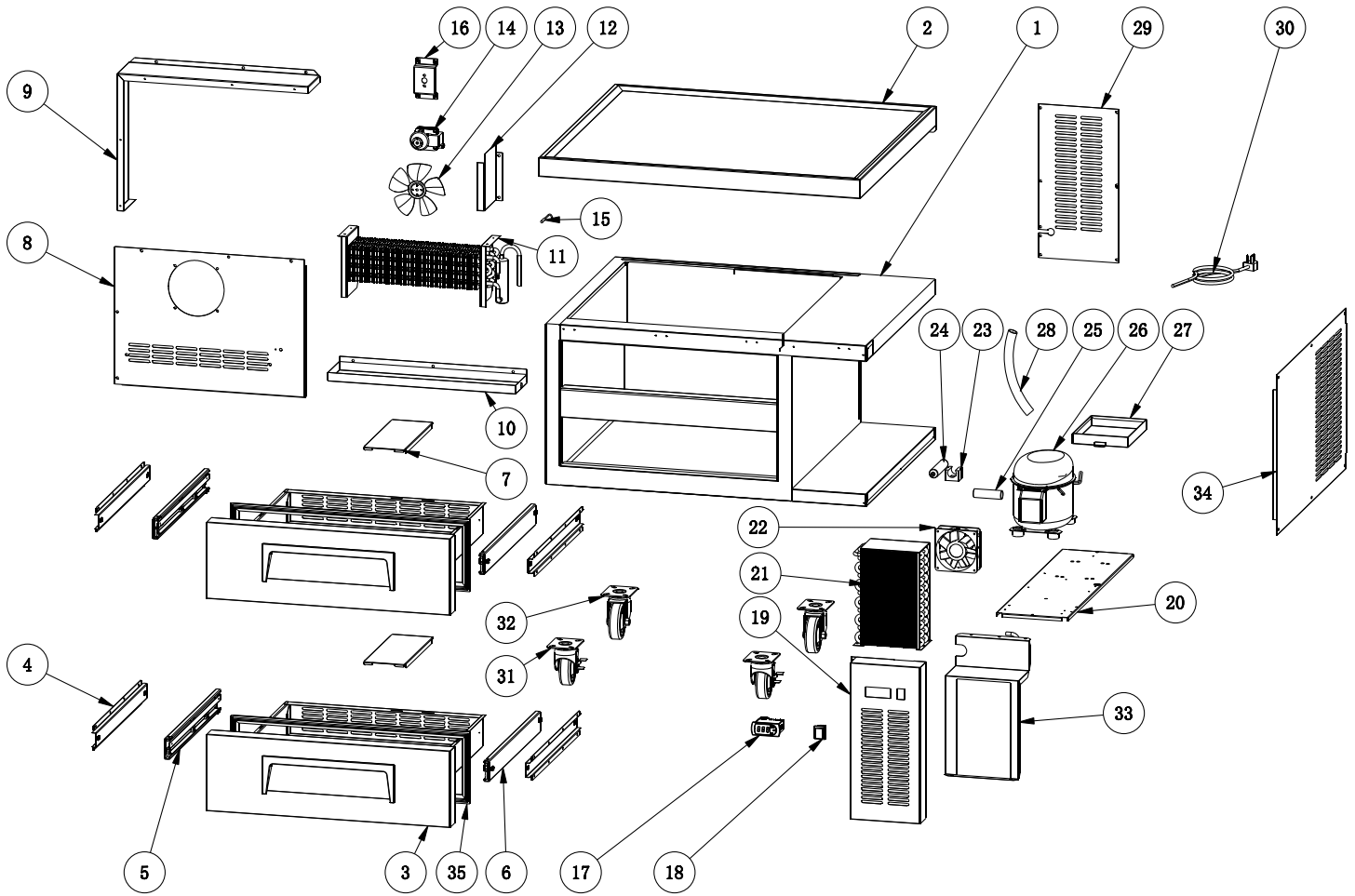

# Parts Breakdown

## Model RE-CN-0036-C 50070

Item No.	Description	Position	Item No.	Description	Position	Item No.	Description	Position
AA108	Cabinet for 50070	1	AA120	Blade of Evaporator Fan Motor for 50070	13	AF182	Compressor for 50070	26
AA109	Top Board for 50070	2	68809	Evaporator Fan Motor EM3020-28-C04 / 110V for 50070	14	AF087	Outer Drain Pan for 50070	27
AA110	Drawer for 50070	3	AA121	Temperature Sensor of Cabinet Inside for 50070	15	AA133	Drain Hose for 50070	28
AA111	Hanging Sheet for Drawer for 50070	4	AA122	Evaporator Fan Motor Holder for 50070	16	AA134	Back Grill for 50070	29
AA112	Drawer Left Slide for 50070	5	AA123	Thermostat for 50070	17	AA135	Power Cord for 50070	30
AA113	Drawer Right Slide for 50070	6	AA124	Power Switch for 50070	18	AA136	4" Castor with Brake for 50070	31
AA114	Pan Bracket for 50070	7	AA125	Control Panel for 50070	19	AA137	4" Castor for 50070	32
AA115	Evaporator Cover for 50070	8	AA126	Compressor Unit Installation Board for 50070	20	AA138	Condenser Air Guide Sheet for 50070	33
AA116	Evaporator Cover Plate for 50070	9	AA127	Condenser for 50070	21	AA139	Air Duct for 50070	34
AA117	Inner Drain Pan for 50070	10	AE901	Evaporator Fan Motor for 50070	22	AG823	Gasket for 50070	35
AA118	Evaporator for 50070	11	AB595	Filter Fixer for 50070	23			
AA119	Air Guide Sheet for 50070	12	AA130	Filter for 50070	24			

# Parts Breakdown

Model RE-CN-0052-C 50071

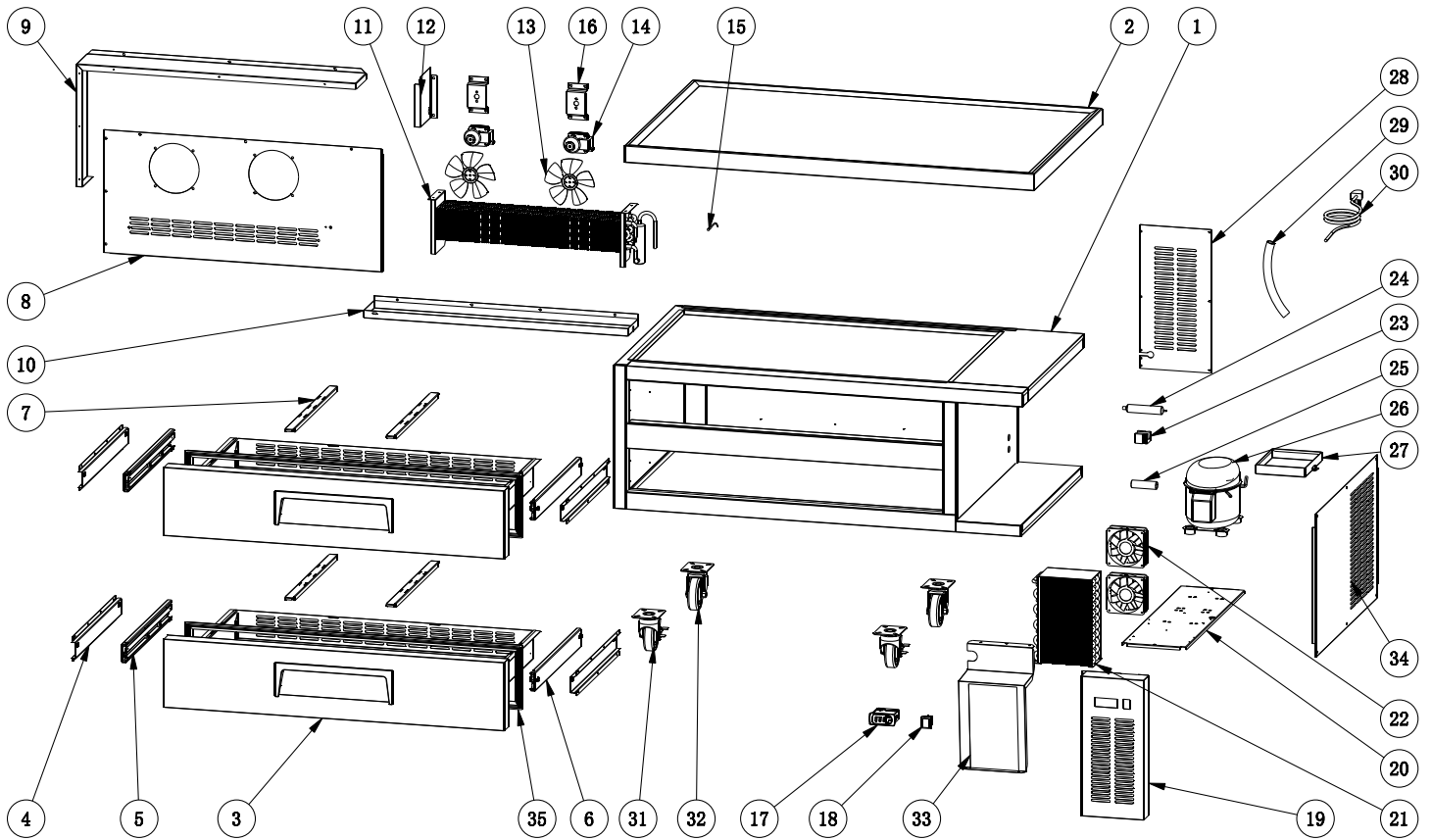

# Parts Breakdown

## Model RE-CN-0052-C 50071

Item No.	Description	Position	Item No.	Description	Position	Item No.	Description	Position
AA140	Cabinet for 50071	1	AA120	Blade of Evaporator Fan Motor for 50071	13	AF182	Compressor for 50071	26
AA141	Top Board for 50071	2	68809	Evaporator Fan Motor EM3020-28-C04 / 110V for 50071	14	AF087	Outer Drain Pan for 50071	27
AA142	Drawer for 50071	3	AA121	Temperature Sensor of Cabinet Inside for 50071	15	AA133	Drain Hose for 50071	28
AA111	Hanging Sheet for Drawer for 50071	4	AA122	Evaporator Fan Motor Holder for 50071	16	AA134	Back Grill for 50071	29
AA112	Drawer Left Slide for 50071	5	AA123	Thermostat for 50071	17	AA135	Power Cord for 50071	30
AA113	Drawer Right Slide for 50071	6	AA124	Power Switch for 50071	18	AA136	4" Castor with Brake for 50071	31
AA146	Pan Bracket for 50071	7	AA125	Control Panel for 50071	19	AA137	4" Castor for 50071	32
AA147	Evaporator Cover for 50071	8	AA126	Compressor Unit Installation Board for 50071	20	AA138	Condenser Air Guide Sheet for 50071	33
AA148	Evaporator Cover Plate for 50071	9	AA155	Condenser for 50071	21	AA139	Air Duct for 50071	34
AA149	Inner Drain Pan for 50071	10	AE901	Evaporator Fan Motor for 50071	22	AG824	Gasket for 50071	35
26955	Evaporator for 50071	11	AB595	Filter Fixer for 50071	23			
AA119	Air Guide Sheet for 50071	12	AA130	Filter for 50071	24			

# Parts Breakdown

Model RE-CN-0072-C 50072

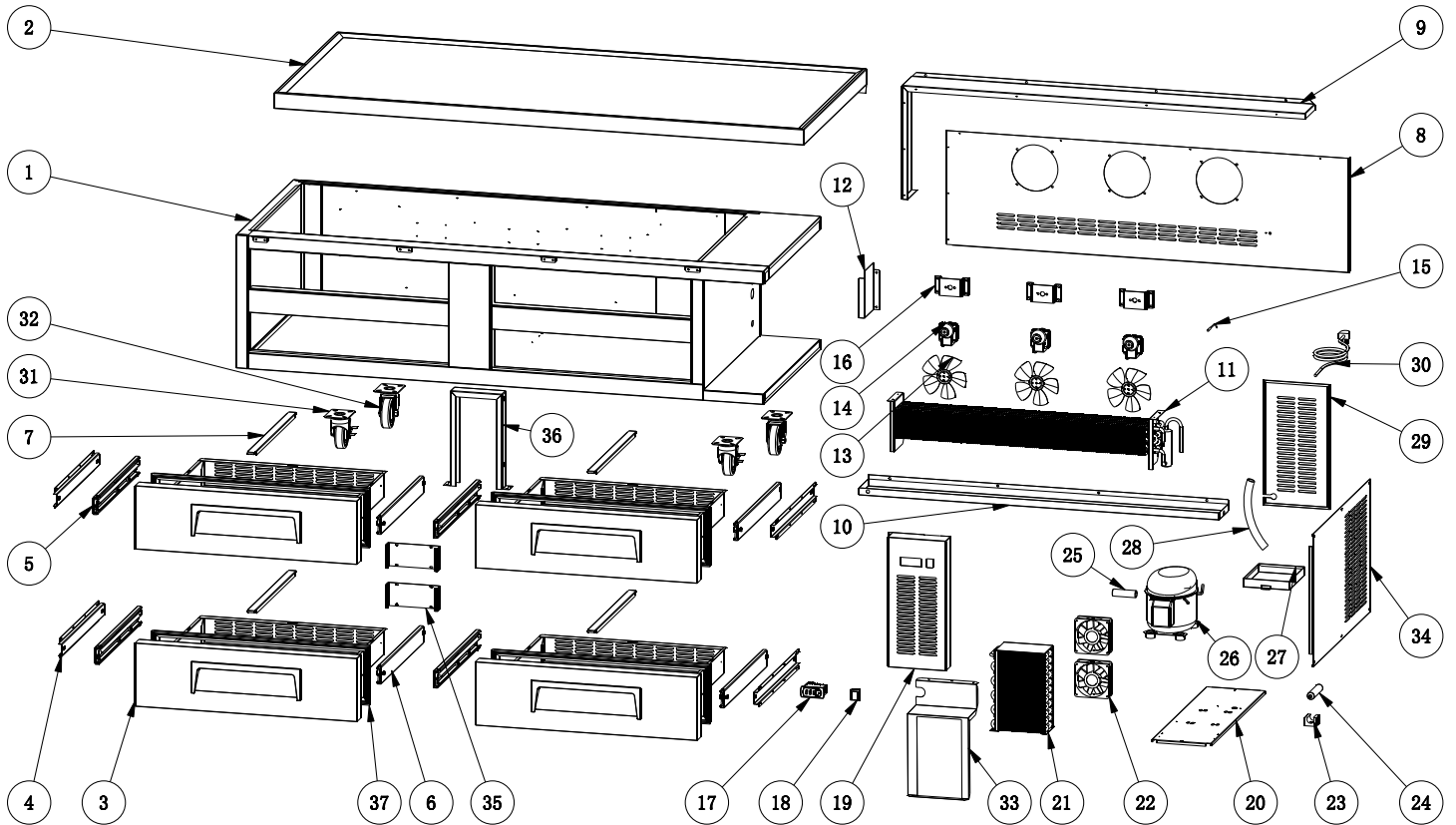

# Parts Breakdown

## Model RE-CN-0072-C 50072

Item No.	Description	Position	Item No.	Description	Position	Item No.	Description	Position
AA161	Cabinet for 50072	1	AA120	Blade of Evaporator Fan Motor for 50072	13	AF088	Compressor for 50072	26
AA162	Top Board for 50072	2	68809	Evaporator Fan Motor EM3020-28-C04 / 110V for 50072	14	AF087	Outer Drain Pan for 50072	27
AA163	Drawer for 50072	3	AA121	Temperature Sensor of Cabinet Inside for 50072	15	AA133	Drain Hose for 50072	28
AA111	Hanging Sheet for Drawer for 50072	4	AA122	Evaporator Fan Motor Holder for 50072	16	AA134	Back Grill for 50072	29
AA112	Drawer Left Slide for 50072	5	AA123	Thermostat for 50072	17	AA135	Power Cord for 50072	30
AA113	Drawer Right Slide for 50072	6	AA124	Power Switch for 50072	18	AA136	4" Castor with Brake for 50072	31
AG825	Pan Bracket for 50072	7	AA125	Control Panel for 50072	19	AA137	4" Castor for 50072	32
AA168	Evaporator Cover for 50072	8	AA126	Compressor Unit Installation Board for 50072	20	AA138	Condenser Air Guide Sheet for 50072	33
AA169	Evaporator Cover Plate for 50072	9	AA155	Condenser for 50072	21	AA139	Air Duct for 50072	34
AA170	Inner Drain Pan for 50072	10	AE901	Evaporator Fan Motor for 50072	22	AA181	Shelf Rail of Middle Beam for 50072	35
AA171	Evaporator for 50072	11	AB595	Filter Fixer for 50072	23	AA182	Back Shelf Rail for 50072	36
AA119	Air Guide Sheet for 50072	12	AA130	Filter for 50072	24	AG478	Door Gasket for 50072	37

# Electrical Schematics

Model RE-CN-0036-C 50070

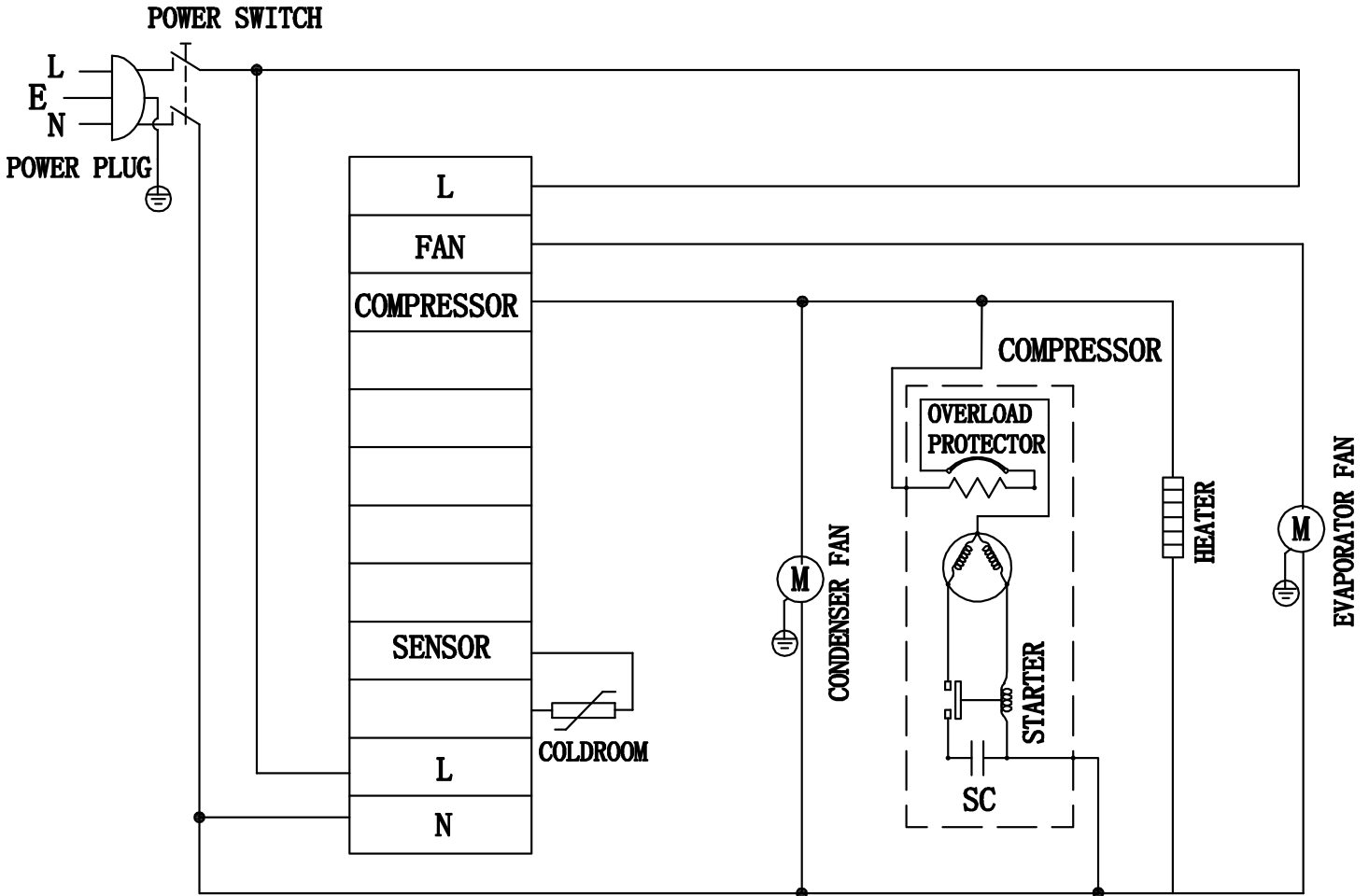

# Electrical Schematics

Model RE-CN-0052-C 50071

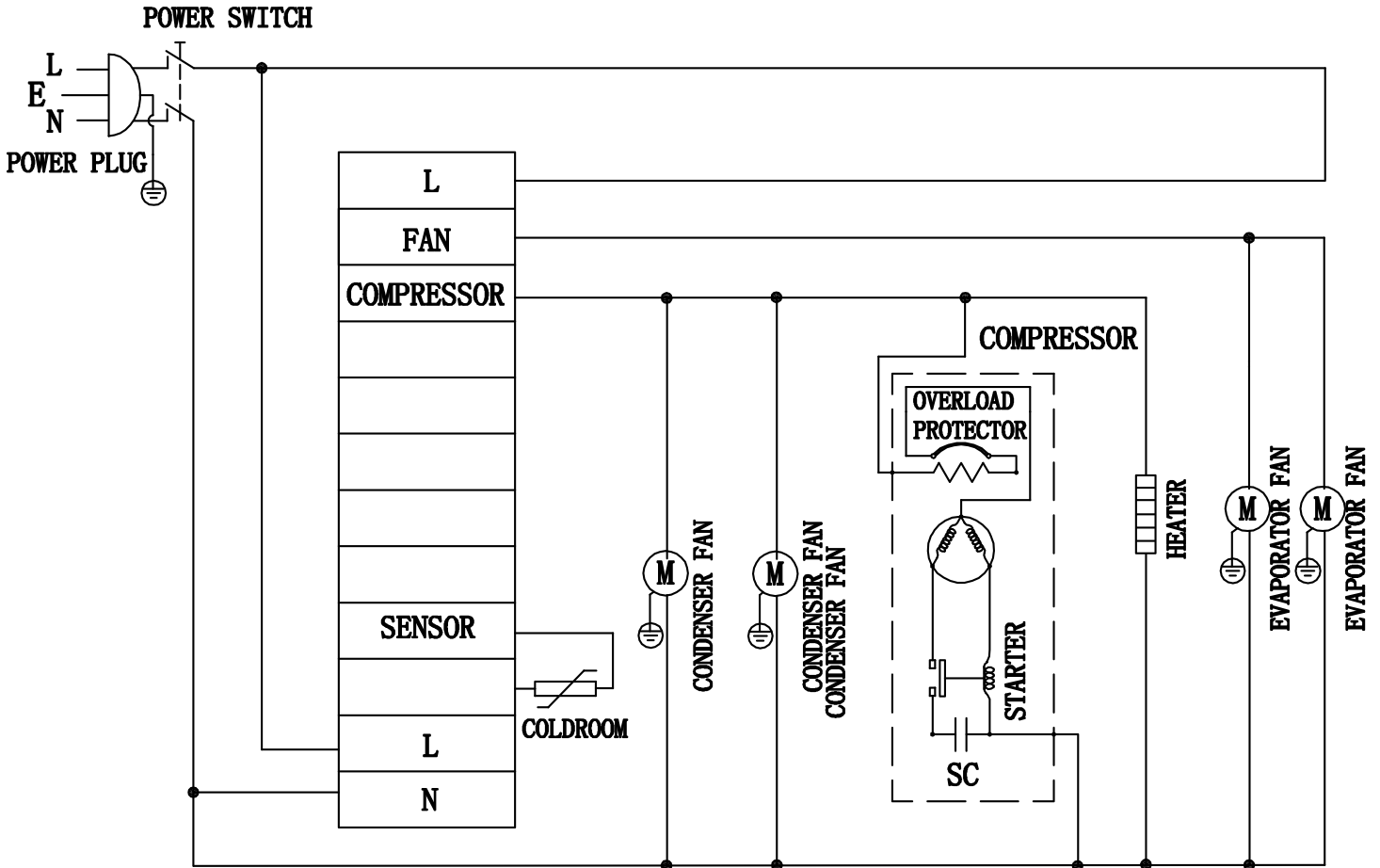

# Electrical Schematics

Model RE-CN-0072-C 50072

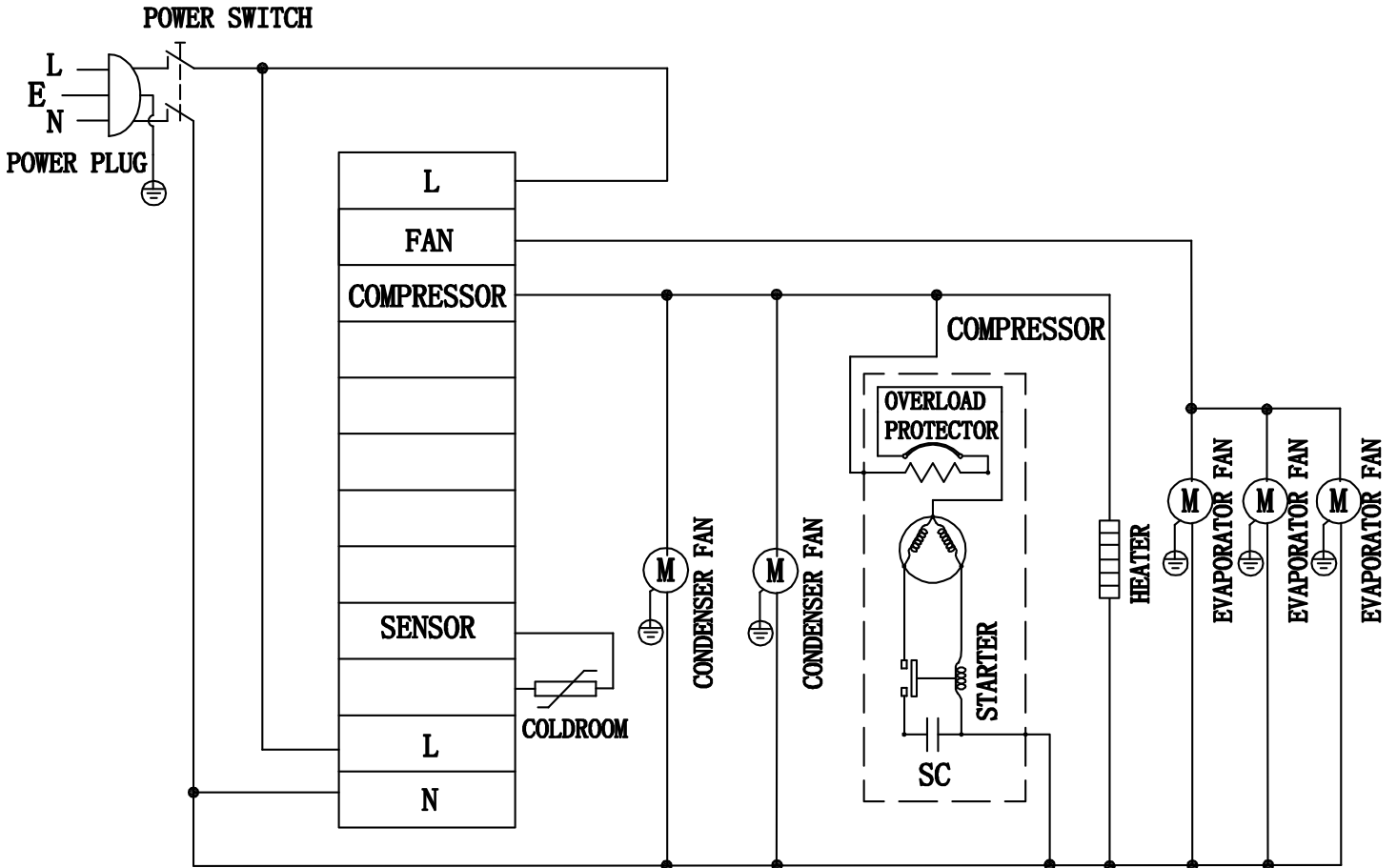









# Warranty Registration

Thank you for purchasing an Omcan product. To register your warranty for this product, complete the information below, tear off the card at the perforation and then send to the address specified below. You can also register online by visiting:

Merci d'avoir acheté un produit Omcan. Pour enregistrer votre garantie pour ce produit, complétez les informations ci-dessous, détachez la carte au niveau de la perforation, puis l'envoyer à l'adresse spécifiée ci-dessous. Vous pouvez également vous inscrire en ligne en visitant:

Gracias por comprar un producto Omcan usted. Para registrar su garantía para este producto, complete la información a continuación, cortar la tarjeta en la perforación y luego enviarlo a la dirección indicada a continuación. También puede registrarse en línea en:

<https://omcan.com/warranty-registration/>

For mailing in Canada

Pour postale au Canada

Por correo en Canadá

**OMCAN**

PRODUCT WARRANTY REGISTRATION

3115 Pepper Mill Court,

Mississauga, Ontario

Canada, L5L 4X5

For mailing in the US

Pour diffusion aux États-Unis

Por correo en los EE.UU.

**OMCAN**

PRODUCT WARRANTY REGISTRATION

4450 Witmer Industrial Estates, Unit 4,

Niagara Falls, New York

USA, 14305

*or email to: [service@omcan.com](mailto:service@omcan.com)*



Purchaser's Information

Name: \_\_\_\_\_

Address: \_\_\_\_\_

City: \_\_\_\_\_ Province or State: \_\_\_\_\_ Postal or Zip: \_\_\_\_\_

Country: \_\_\_\_\_

Dealer from which Purchased: \_\_\_\_\_

Dealer City: \_\_\_\_\_ Dealer Province or State: \_\_\_\_\_

Invoice: \_\_\_\_\_

Model Name: \_\_\_\_\_ Model Number: \_\_\_\_\_

Machine Description: \_\_\_\_\_

Date of Purchase (MM/DD/YYYY): \_\_\_\_\_

Would you like to extend the warranty?  Yes  No

Company Name: \_\_\_\_\_

Telephone: \_\_\_\_\_

Email Address: \_\_\_\_\_

Type of Company:

Restaurant  Bakery  Deli

Butcher  Supermarket  Caterer

Institution (specify): \_\_\_\_\_

Other (specify): \_\_\_\_\_

Serial Number: \_\_\_\_\_

Date of Installation (MM/DD/YYYY): \_\_\_\_\_

**Thank you for choosing Omcan | Merci d'avoir choisi Omcan | Gracias por elegir Omcan**



Since 1951 Omcan has grown to become a leading distributor of equipment and supplies to the North American food service industry. Our success over these many years can be attributed to our commitment to strengthen and develop new and existing relationships with our valued customers and manufacturers. Today with partners in North America, Europe, Asia and South America, we continually work to improve and grow the company. We strive to offer customers exceptional value through our qualified local sales and service representatives who provide convenient access to over 6,500 globally sourced products.

---

Depuis 1951 Omcan a grandi pour devenir un des “leaders” de la distribution des équipements et matériel pour l’industrie des services alimentaires en Amérique du Nord. Notre succès au cours de ces nombreuses années peut être attribué à notre engagement à renforcer et à développer de nouvelles et existantes relations avec nos clients et les fabricants de valeur. Aujourd’hui avec des partenaires en Amérique du Nord, Europe, Asie et Amérique du Sud, nous travaillons continuellement à améliorer et développer l’entreprise. Nous nous efforçons d’offrir à nos clients une valeur exceptionnelle grâce à nos ventes locales qualifiées et des représentants de service qui offrent un accès facile à plus de 6500 produits provenant du monde entier.

---

Desde 1951 Omcan ha crecido hasta convertirse en un líder en la distribución de equipos y suministros de alimentos en América del Norte industria de servicios. Nuestro éxito en estos años se puede atribuir a nuestro compromiso de fortalecer y desarrollar nuevas relaciones existentes con nuestros valiosos clientes y fabricantes. Hoy con socios de América del Norte, Europa, Asia y América del Sur, que trabajan continuamente para mejorar y crecer la empresa. Nos esforzamos por ofrecer a nuestros clientes valor excepcional a través de nuestro local de ventas y representantes de los servicios que proporcionan un fácil acceso a más de 6,500 productos con origen a nivel mundial.

