



Santos Cold Press Juicer

Model Santos 65

Item 45923

Instruction Manual



Revised - 11/25/2020



Toll Free: 1-800-465-0234
Fax: 905-607-0234
Email: service@omcan.com
www.omcan.com

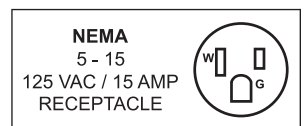

Table of Contents

Model Santos 65

Section	Page
General Information -----	3 - 4
Safety and Warranty -----	4 - 6
Technical Specifications -----	7
Operation -----	7 - 8
Maintenance -----	8 - 9
Troubleshooting -----	9 - 10
Figure Drawings -----	10 - 13
Parts Breakdown -----	14 - 16
Electrical Schematics -----	17
Notes -----	18
Warranty Registration -----	19



General Information

Omcan Manufacturing and Distributing Company Inc., Food Machinery of America, Inc. dba Omcan and Omcan Inc. are not responsible for any harm or injury caused due to any person's improper or negligent use of this equipment. The product shall only be operated by someone over the age of 18, of sound mind, and not under the influence of any drugs or alcohol, who has been trained in the correct operation of this machine, and is wearing authorized, proper safety clothing. Any modification to the machine voids any warranty, and may cause harm to individuals using the machine or in the vicinity of the machine while in operation.

CHECK PACKAGE UPON ARRIVAL

Upon receipt of an Omcan shipment please inspect for external damage. If no damage is evident on the external packaging, open carton to ensure all ordered items are within the box, and there is no concealed damage to the machine. If the package has suffered rough handling, bumps or damage (visible or concealed), please note it on the bill of lading before accepting the delivery and contact Omcan within 24 hours, so we may initiate a claim with the carrier. A detailed report on the extent of the damage caused to the machine must be filled out within three days, from the delivery date shown in the shipping documents. Omcan has no recourse for damaged products that were shipped collect or third party.

Before operating any equipment, always read and familiarize yourself with all operation and safety instructions.

Omcan would like to thank you for purchasing this machine. It's of the utmost importance to save these instructions for future reference. Also save the original box and packaging for shipping the equipment if servicing or returning of the machine is required.

Omcan Fabrication et distribution Compañie Limité et Food Machinery d'Amérique, dba Omcan et Omcan Inc. ne sont pas responsables de tout dommage ou blessure causé du fait que toute personne ait utilisé cet équipement de façon irrégulière. Le produit ne doit être exploité que par quelqu'un de plus de 18 ans, saine d'esprit, et pas sous l'influence d'une drogue ou d'alcool, qui a été formé pour utiliser cette machine correctement, et est vêtu de vêtements de sécurité approprié. Toute modification de la machine annule toute garantie, et peut causer un préjudice à des personnes utilisant la machine ou des personnes à proximité de la machine pendant son fonctionnement.

VÉRIFIEZ LE COLIS DÈS RÉCEPTION

Dès réception d'une expédition d'Omcan veuillez inspecter pour dommages externes. Si aucun dommage n'est visible sur l'emballage externe, ouvrez le carton afin de s'assurer que tous les éléments commandés sont dans la boîte, et il n'y a aucun dommage dissimulé à la machine. Si le colis n'a subi aucune mauvaises manipulations, de bosses ou de dommages (visible ou cachée), notez-le sur le bond de livraison avant d'accepter la livraison et contactez Omcan dans les 24 heures qui suivent, pour que nous puissions engager une réclamation auprès du transporteur. Un rapport détaillé sur l'étendue des dommages causés à la machine doit être rempli dans un délai de trois jours, à compter de la date de livraison indiquée dans les documents d'expédition. Omcan n'a aucun droit de recours pour les produits endommagés qui ont été expédiés ou cueilli par un tiers transporteur.

General Information

Avant d'utiliser n'importe quel équipement, toujours lire et vous familiariser avec toutes les opérations et les consignes de sécurité.

Omcan voudrais vous remercier d'avoir choisi cette machine. Il est primordial de conserver ces instructions pour une référence ultérieure. Également conservez la boîte originale et l'emballage pour l'expédition de l'équipement si l'entretien ou le retour de la machine est nécessaire.

Omcan Empresa De Fabricacion Y Distribucion Inc. Y Maquinaria De Alimentos De America, Inc. dba Omcan y Omcan Inc. no son responsables de ningun daño o perjuicio causado por cualquier persona inadecuada o el uso descuidado de este equipo. El producto solo podra ser operado por una persona mayor de 18 años, en su sano juicio y no bajo alguna influencia de droga o alcohol, y que este ha sido entrenado en el correcto funcionamiento de esta máquina, y ésta usando ropa apropiada y autorizada. Cualquier modificación a la máquina anula la garantía y puede causar daños a las personas usando la máquina mientras esta en el funcionamiento.

REVISE EL PAQUETE A SU LLEGADA

Tras la recepcion de un envio Omcan favor inspeccionar daños externos. Si no hay daños evidentes en el empaque exterior, Habra el carton para asegurarse que todos los articulos solicitados estén dentro de la caja y no encuentre daños ocultos en la máquina. Si el paquete ha sufrido un manejo de poco cuidado, golpes o daños (visible o oculto) por favor anote en la factura antes de aceptar la entrega y contacte Omcan dentro de las 24 horas, de modo que podamos iniciar una reclamación con la compañía. Un informe detallado sobre los daños causados a la máquina debe ser llenado en el plazo de tres días, desde la fecha de entrega que se muestra en los documentos de envío. Omcan no tiene ningun recurso por productos dañados que se enviaron a recoger por terceros.

Antes de utilizar cualquier equipo, siempre lea y familiarizarse con todas las instrucciones de funcionamiento y seguridad.

Omcan le gustaría darle las gracias por la compra de esta máquina. Es de la mayor importancia para salvar estas instrucciones para futuras consultas. Además, guarda la caja original y el embalaje para el envío del equipo si servicio técnico o devolución de la máquina que se requiere.

Safety and Warranty

When using, maintaining or disposing of the machine, always follow these basic instructions.

Read all instructions

Note: you will find it easier to understand the next few paragraphs if you refer to the diagrams at the end of this manual.

Safety and Warranty

INSTALLATION AND HANDLING

During unpacking in particular, you are advised to have 2 people to handle the machine. For ease of use, it is recommended the machine is placed on a table or work surface so as to have the juice spout in front of you (recommended height: 90 cm, to be adapted as required to the user).

Warning: watch out for a possible slippery floor adjacent to the appliance.

During cleaning and installation, handle the sieve (13), carefully so as not to put it out of shape thus preventing the machine from working properly.

IMPROPER USE

1. Do not place food in the feed channel and press with the plunger before you have started the machine.
2. The appliance is not designed for handling frozen foods.
3. Remove stones from fruit before processing it in the machine (e.g. mangoes, apricots, peaches). Do not let the stones go into the machine.
4. Do not place anything other than food in the feed channel.
5. Do not place hard food in the feed channel.
6. The machine must not be left to operate without supervision.
7. Neither a hose nor a pressure hose should be used for cleaning.
8. Do not use abrasive sponges for cleaning the basket.
9. The appliance must not be used on any surface which has a slope of more than 10° relative to the horizontal. The machine's 4 feet must always be resting on this surface. The machine's motor spindle must always be vertical relative to this surface.
10. Never plunge the base in water or any other liquid for reasons of protection against risks of electrocution.
11. The appliance must be unplugged before any intervention on it: cleaning, servicing, maintenance.
12. The use of spare parts other than certified original Omcan parts is prohibited.
13. Do not use the appliance if the power supply cord is damaged. It must be replaced by either a Omcan approved dealer, Omcan or a person with similar qualifications to avoid any danger.
14. Never connect several appliances to the same power socket.
15. Never use the appliance outdoors.
16. Never place the appliance close to or on a source of heat.
17. This appliance is a professional machine designed exclusively for professional use. It is not designed for household use.
18. This appliance is not designed for use by people (including children) whose physical, sensorial or mental capacities are impaired or by people with no experience or knowledge, unless they have been supervised or given training in the use of the appliance beforehand by a person responsible for their safety.

Supervise children to ensure they do not play with the appliance.

CAREFUL:

- Before connecting the machine, check that the mains electrical voltage is the same as the voltage for your appliance. Its value is shown:
 - either on the identification plate under or behind the machine.

Safety and Warranty

- or in the technical specification section of this manual.

- If the power supply cable (22) is damaged, it should be replaced by a Omcan approved dealer, Omcan or a person with similar qualifications to avoid any danger.
- The plug must remain easily accessible while the appliance is in use.

USING FOR THE 1ST TIME

1. Lift up the cover (2) after turning the unlocking lever (6) by one quarter of a turn. Fig. 2.
2. Lock the cover (2) in the top position.
3. Turn and remove the bowl (1). Fig. 3.
4. Remove the top screw (11).
5. Remove the bottom screw (12).
6. Remove the sieve (13) with the 2 scrapers (15).
7. Unscrew the discharge cone (17) by pressing down and remove the seal (18) and the ring (19). Fig.4.
8. Wash all the components in contact with the food in clean water: the plunger (4), the feed channel (3), the bowl (1), the top screw (11), the bottom screw (12), the sieve (13), the scrapers (15), the discharge cone (17), the seal (18), the ring (19) and the pulp container (5). Fig.5.

1 YEAR PARTS AND LABOUR BENCH WARRANTY

Within the warranty period, contact Omcan Inc. at 1-800-465-0234 to schedule a drop off to either an Omcan authorized service depot in the area, or to an Omcan Service warehouse to repair the equipment.

Unauthorized maintenance will void the warranty. Warranty covers electrical and part failures, not improper use.

Please see <https://omcan.com/disclaimer> for complete info.

WARNING:

The packaging components are classified as normal solid urban waste and can therefore be disposed of without difficulty.

In any case, for suitable recycling, we suggest disposing of the products separately (differentiated waste) according to the current norms.

DO NOT DISCARD ANY PACKAGING MATERIALS IN THE ENVIRONMENT!

Technical Specifications

Model	SANTOS 65
Power	650 W
Electrical	120V / 60Hz / 1
Current	5A
RPM	80 RPM
Dimensions	9.3" x 16.2" x 25.3" / 236 x 411 x 643mm
Weight	61.7 lbs. / 28 kgs.
Packaging Weight	70.5 lbs. / 32 kgs.
Item Number	45923

Operation

STARTING UP

ASSEMBLY AND PREPARATION

1. Fit the scrapers (15) around the sieve (13) and insert the assembly into the bottom of the bowl (1). Fig.6.
Careful: line up the pins of the bowl (1) with the housings of the sieve (13). Fig.7.
2. Turn over the bowl (1) and fit the ring (19), the seal (18) before screwing in the discharge cone (17). Fig.9 and Fig.10.
3. Place the bowl (1) on the machine.
4. Position the bottom screw (12). Fig.11.
Careful: position the 2 bosses of the screw (12) in the 2 housings of the scrapers (15). Fig.14.
5. Position the top screw (11). Fig.12.
6. Turn the unlocking lever (6) a quarter of a turn and lower the cover (2).
Careful: if the cover (2) is not locked (unlocking lever not aligned with the appliance, Fig.13), raise it and turn the top screw slightly (11) or check the position of the internal screw (12).
7. Position the feed channel (3). Fig.15.
8. Install the scrap bucket (5).
9. Connect the power supply cord plug (22) to your mains support socket. Fig.16.
10. Remove the fruit plunger (4) from the feed channel (3).

USE

1. Place the recipient under the bowl spout (1).
2. Start the machine, by operating the "On/Off" button (9).
3. Introduce the food into the feed channel (3) and, if required, push it down with the fruit plunger (4).
4. Continue this operation until the juice recipient is full or all the fruit and vegetables to be processed have been used. Also keep an eye on the level of pulp in the pulp container (5).

SIEVE

The appliance comes with a sieve (13) with small holes for juices. A sieve (14) with big holes for coulis is avail-

Operation

able as an option. Fig.8.

HOW TO STOP THE MACHINE

The appliance is stopped:

1. By pushing the "On/Off" push button (9).
2. By unplugging the mains cord plug (22).

DETECTION OF HARD FOOD

The machine can detect when hard food is inserted inside. In this case, it automatically performs up to 3 successive reciprocating movements to try and unblock the screws. If after this operation, there is still local friction, the machine will stop. It is then necessary to take down the screws and clean them.

Maintenance

JAMMING

Food may get jammed in the screw and prevent more from going through. You are advised to perform a backward operation for a few seconds by pressing the backward operation button (10) for a few seconds. Repeat this operation several times as required. If the jam persists, take down the screws and clean them.

CLEANING

Handle the sieve (13) and the screws (11/12) carefully so as not to put them out of shape thus preventing the machine from working properly. To clean the sieve (13), it is recommended to use the brush (23) supplied with the machine, for proper cleaning of the filter sieve holes. Do not use abrasive sponges for cleaning the machine. Take down the seals (16), (18), (20) and (21) to clean them with the brushes (23) and (24) and put them back as shown in the photos Fig.17, Fig.9, Fig.22, and Fig.20. Cleaning will be easier if you do not wait for the food remains to dry in the moving parts of the machine.

PRECAUTIONS AND RISKS

Do not place any objects other than food in the machine. During preparation, the level in the pulp container (5) should be monitored to prevent the pulp outlet from clogging. Such clogging could result in a machine dysfunction. The quantity of products to be processed before reaching the maximum filling level in the container (5) varies according on the products being processed.

MOTOR OVERHEATING SAFETY FEATURE

In the event of one of the 2 motors overheating, the appliance stops automatically. The safety features have an automatic reset, so wait for the motors to cool (15 to 30 minutes), before restarting the machine. If the problem persists, switch off the power supply to the machine (unplug the cord from the mains socket (22)) and call in the maintenance service or contact a Omcan approved dealer.

SAFE ACCESS TO THE TOOLS

The juice extractor can only be started if the feed channel (3) and bowl (1) are positioned correctly and the cover (2) is locked in the lowered position. Removing the feed channel (3) or lifting the cover (2) results in the machine stopping. Re-starting the juice extractor requires specific operation of the “On/Off” push button (9) again. A cut in the mains power supply stops the machine.

MAINTENANCE

Before carrying out any work on the cold press juicer, it must in all cases be unplugged from the mains power supply and wait 20 seconds for the capacitor of the electronic board to discharge.

SPARE PARTS

IMPORTANT: The use of spare parts other than certified original Omcan parts is prohibited.

This machine requires no specific maintenance because the bearings are lubricated for life. If any intervention is necessary to replace parts subject to wear, such as the sieve (13), the scrapers (15), the seals (16), (18), (20), (21), the electrical or other components, please refer to the parts list (see the exploded view at the end of this manual). For all spare part orders (see references in the exploded view at the end of the manual), state the type, the machine serial number and the electrical specifications recorded under the machine.

SERVICING

Neither a hose nor a pressure hose should be used for cleaning.

- After use, clean the plunger (4), the feed channel (3), the bowl (1), the top screw (11), the bottom screw (12), the sieve (13), the scrapers (15), the discharge cone (17), the seal (18), the ring (19) and the pulp container (5) in clean water or with a dish washing detergent product designed for this purpose. Then rinse and dry. Do not use abrasive products or materials to clean the basket assembly.
- The base is to be cleaned with a soft damp sponge, then dried.

CAREFUL

For easier cleaning, do not leave food remains to dry on the parts in contact with the food and clean all these parts of the machine immediately after the work is finished.

Troubleshooting

THE MACHINE WILL NOT START

- Check: the mains supply and the condition of the power supply cord.
- Check: the presence of the feed channel (3) and the locking of the cover (2) in the lowered position Fig.13.

Troubleshooting

THE MACHINE STOPS BECAUSE THE MOTOR HAS OVERHEATED (THE CASINGS AROUND THE MOTOR UNITS ARE HOT)

- Remove the plug from the power supply socket and follow the instructions in the section on “motor over-heat safety feature”.

THE MACHINE STOPS BECAUSE OF A JAM

- See the section on “jamming”.

THE MACHINE IS NOISY

- Check the parts are positioned correctly.
- Check no part has been damaged by a fall or the suchlike: if so, replace this part.

Figure Drawings

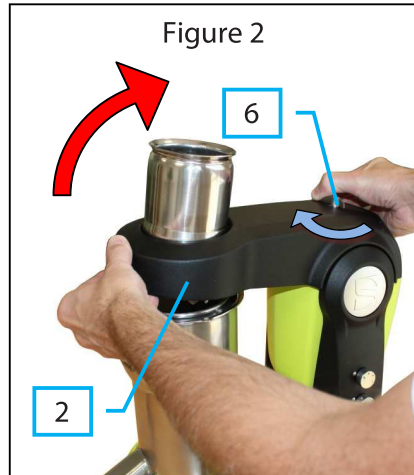

Figure Drawings

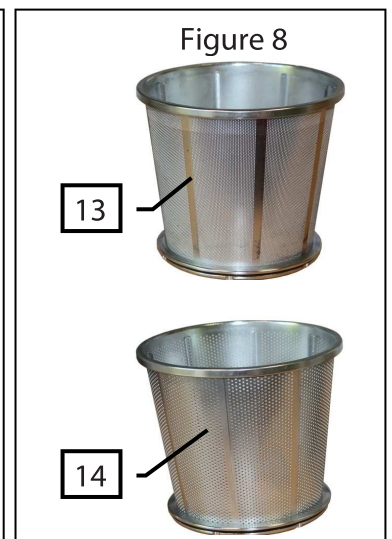
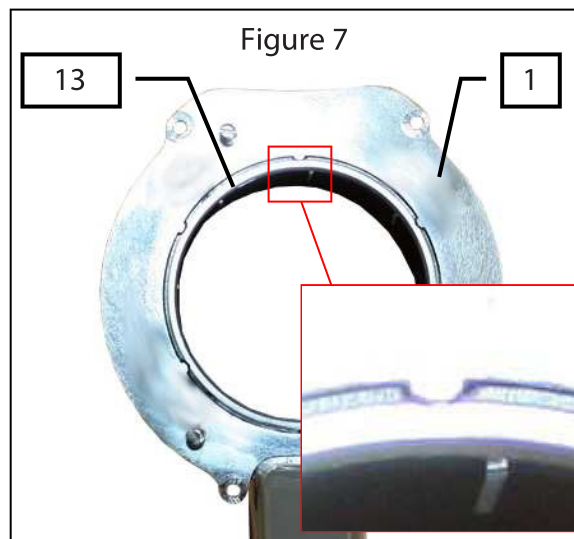
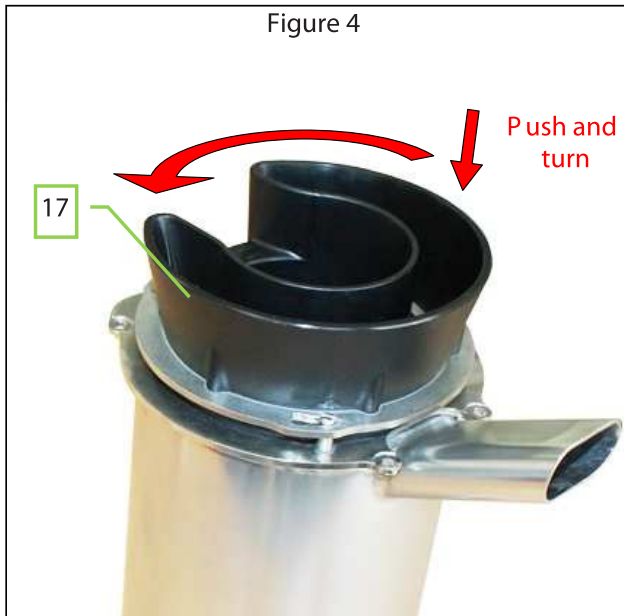

Figure Drawings

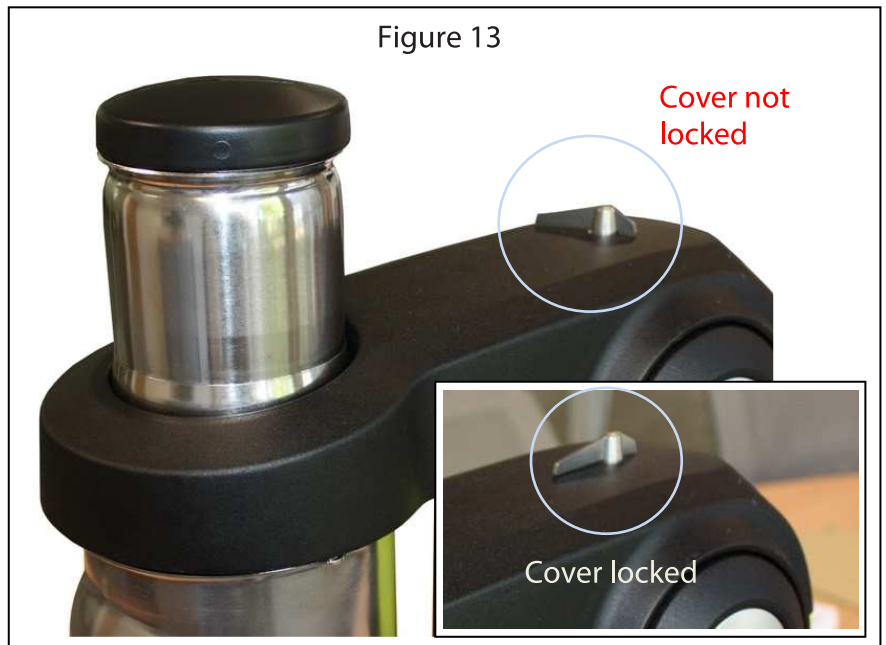
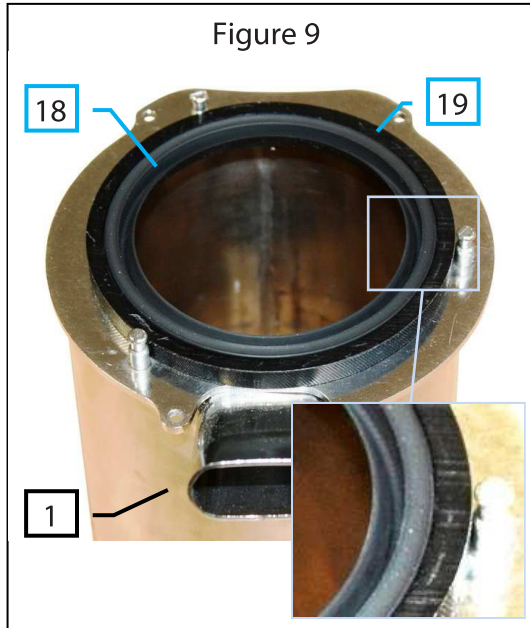
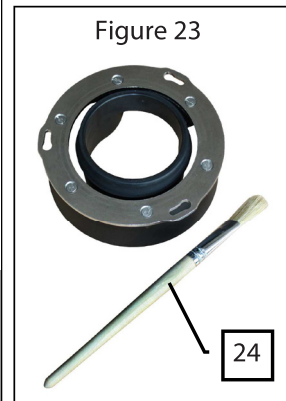
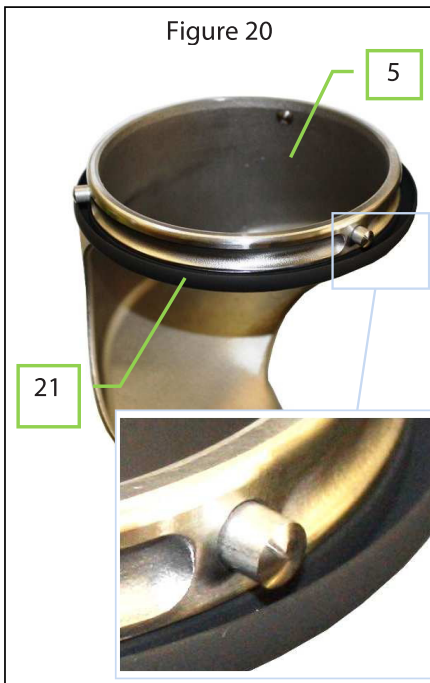
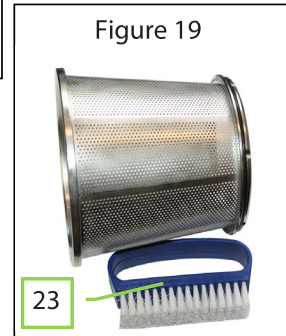
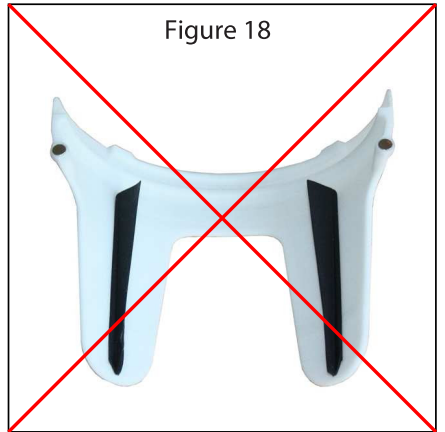
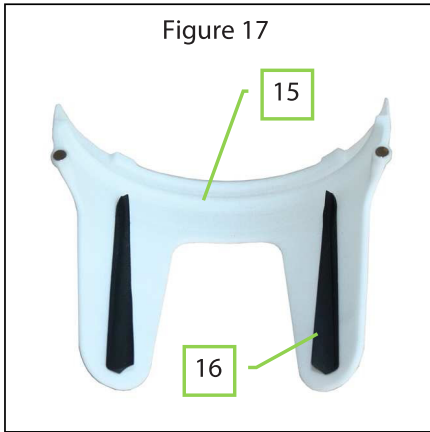
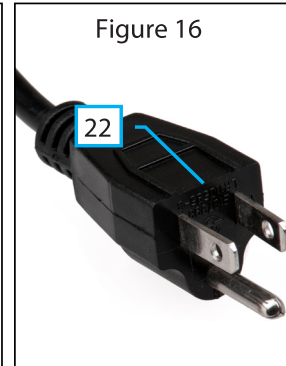

Figure Drawings



Parts Breakdown

Model SANTOS 65 45923

Item No.	Description	Position	Item No.	Description	Position	Item No.	Description	Position
AD958	Pusher for 45923	65101	AD999	Locking Spring for 45923	65318	AE040	Spacer M3x20 for 45923	65387
AD959	Feeding Tube for 45923	65102	AE000	Locking Handle Axle for 45923	65321	AE041	Top Motor Casing for 45923	65391
AD960	Container Cap for 45923	65104	AE001	Locking Handle for 45923	65322	AE042	Motor Casing Seal for 45923	65392
AD961	Pulp Tube for 45923	65105	AE002	Screw CBX M3x6 for 45923	65323	AE043	Screw M5x10 Stainless Steel for 45923	65393
AD962	Complete Filter Body for 45923	65201	AE003	Pulleys Holding Plate for 45923	65331	AE044	Upper Belt for 45923	65396
AD963	Stainless Steel Upper Screw (01/2018) for 45923	65202	AE004	Safety Switch for 45923	65332	AE045	Right Arm for 45923	65401
AD964	Driving Pin for 45923	65203	AE005	Screw Safety Axle for 45923	65333	AE046	Left Arm for 45923	65402
AD965	Top Screw Seal for 45923	65204	AE006	Spacer 5x8x6 for 45923	65334	AE047	Right Arm Plate for 45923	65403
AD966	Stainless Steel Lower Screw for 45923	65206	AE007	Screw 5x20 for 45923	65335	AE048	Left Arm Plate for 45923	65404
AD967	Bottom Screw Seal for 45923	65207	AE008	Spacer M4x24 for 45923	65336	AE049	Screw CHC M6x60 for 45923	65405
AD968	Locking Axle for 45923	65208	AE009	Screw H M4x12 ZN for 45923	65337	AE050	Screw 6x25 for 45923	65406
AD969	Locking Screw for 45923	65209	AE010	Split Washer Diam 4 ZN for 45923	65338	AE051	Grower Washer W 6 ZN for 45923	65407
AD970	Stainless Steel Upper Screw for 45923	65210	AE011	Screw H M4x16 for 45923	65339	AE052	Screw FZ M3x10 ZN for 45923	65408
AD971	O-Ring 85x2 for 45923	65219	AE012	Upper Tensioning Axle for 45923	65341	AE053	Locking Ring for 45923	65409
AD972	0.3 Mesh with O-Ring Seal 85x2 for 45923	65220	AE013	Washer 8x130 for 45923	65342	AE054	Right Arm with 2 Rings for 45923	65410
AD973	Complete 0.8 Mesh (Option) for 45923	65221	AE014	Bronze Bearing 25x30x25 for 45923	65343	AE055	Potentiometer for 45923	65411
AD974	Complete Wiper for 45923	65260	AE015	Grower Washer W 6 ZN for 45923	65344	AE056	Stainless Steel Pin 2x4 for 45923	65412
AD975	Outside Screw Seal for 45923	65263	AE016	Screw H M6x20 ZN for 45923	65345	AE057	Button for 45923	65413
AD976	Rubber Scraper for 45923	65264	AE017	Tube Safety Axle for 45923	65346	AE058	Screw HC M4x6 for 45923	65414
AD977	Scraper Holder with Magnets for 45923	65265	AE018	Washer 6x14 for 45923	65347	AE059	Pin 3x14 Stainless Steel for 45923	65418
AD978	Seal Outside Ring for 45923	65266	AE019	Safety Spring for 45923	65348	AE060	Left Arm with 2 Rings for 45923	65420
AD979	Cone Holder Plate for 45923	65271	AE020	Safety Spring Tube for 45923	65349	AE061	On Off Push Button for 45923	65421
AD980	Waste Output Cone for 45923	65272	AE021	PCB Assembly CPJ65 110V for 45923	65350B	AE062	Reverse Push Button for 45923	65422
AD981	Screw Seal (Inside) for 45923	65273	AE022	Top Motor Holding Plate for 45923	65361	AE063	Mask for 45923	65431
AD982	Screw 3.5x10 Stainless Steel for 45923	65274	AE023	Top Motor Cage for 45923	65362	AE064	Middle Cast for 45923	65501
AD983	Top Screw with Pins for 45923	65280	AE024	Screw FX M4x16 for 45923	65363	AE065	Lower Motor Holding Plate for 45923	65502
AD984	Upper Screw Brushing for 45923	65282	AE025	Bronze Bearing 16x20x20 for 45923	65364	AE066	110V 300W Motor for 45923	65503B
AD985	Top Casing for 45923	65301	AE026	Top Driving Pulley for 45923	65365	AE067	Spacer 6x9x16 for 45923	65504
AD986	Safety Ring for 45923	65302	AE027	Washer 4x14 for 45923	65366	AE068	Screw H M6x30 ZN for 45923	65505
AD987	Body Top Guide for 45923	65303	AE028	17 Teeth Pinion for 45923	65371	AE069	Grower Washer W 6 ZN for 45923	65506
AD988	Screw CHC (+Step) M6x10 for 45923	65304	AE029	100W Motor 110V for 45923	65372B	AE070	Screw H M6x12 ZN for 45923	65507
AD989	Top Casing with Rings for 45923	65305	AE030	Pinion + 110V Motor Assembly for 45923	65373B	AE071	Nut H M6 ZN for 45923	65508
AD990	Screw H M5x12 ZN for 45923	65306	AE031	Gearbox Motor Top Spacer for 45923	65374	AE072	Lower Pulley for 45923	65511
AD991	Plastic Bearing 5x7x10 for 45923	65307	AE032	Planetary Gearbox for 45923	65375	AE073	Locking Washer for 45923	65512
AD992	Locking Cam for 45923	65311	AE033	Screw H M5x10 ZN for 45923	65377	AE074	Parallel Key 4x4x12 for 45923	65513
AD993	Locking Plate for 45923	65312	AE034	Washer AZ 5 ZN for 45923	65378	AE075	Screw FX M4x10 for 45923	65514
AD994	Pin 3x20 for 45923	65313	AE035	Top Coupling for 45923	65382	AE076	Main Gearbox Axle for 45923	65521
AD995	Lock for 45923	65314	AE036	Upper Ring for 45923	65383	AE077	Bearing 6002 ZZ for 45923	65522
AD996	Pin 3x12 for 45923	65315	AE037	Top Cover Sheet for 45923	65384	AE078	Screw M5x12 IN for 45923	65524
AD997	Locking Washer 3 for 45923	65316	AE038	Screw H M4x8 ZN Auto for 45923	65385	AE079	Main Gearbox Axle Assembly for 45923	65525
AD998	Screw CS M3x16 ZN for 45923	65317	AE039	Screw FZ M3x10 ZN for 45923	65386	AE080	Lower Belt for 45923	65526

Parts Breakdown

Model SANTOS 65 45923

Item No.	Description	Position	Item No.	Description	Position	Item No.	Description	Position
AE081	Planetary Gearbox for 45923	65531	AE092	Screw H M5x16 ZN Auto for 45923	65548	AE103	Screw H M6x16 for 45923	65604
AE082	Driving Axle for 45923	65532	AE093	Lower Body for 45923	65561	AE104	Bottom Plate for 45923	65611
AE083	Screw HC M3x5 for 45923	65533	AE094	Large Motor Sheet for 45923	65562	AE105	Foot for 45923	65612
AE084	Main Gearbox Shield for 45923	65534	AE095	Screw RLS M4x8 Stainless Steel for 45923	65563	AE106	Screw H M5x10 ZN for 45923	65613
AE085	14 Teeth Pinion for 45923	65536	AE096	Lower Transmission Cover for 45923	65564	AE107	Power Cord with USA Plug for 45923	65615
AE086	Main Gearbox Protection Sheet for 45923	65537	AE097	Lower Body Guide for 45923	65565	AE108	Screw H M4x8 ZN Auto for 45923	65616
AE087	Spring Plate for 45923	65541	AE098	Spacer M3x20 for 45923	65566	AE109	EMC Filter 230V for 45923	65625
AE088	Main Tensioner Axle for 45923	65542	AE099	Screw FZ M3x10 ZN for 45923	65567	AE110	Nut HM 4 ZN for 45923	65626
AE089	Ball Bearing 6203 for 45923	65543	AE100	Painted Base for 45923	65601	AE111	Washer AZ 4 ZN for 45923	65627
AE090	Screw H M6x20 ZN for 45923	65544	AE101	Screw H M5x12 ZN for 45923	65602	AE112	Screw H M4x12 ZN for 45923	65628
AE091	Nut Autolock H M6 for 45923	65547	AE102	Washer AZ 6 for 45923	65603			

Electrical Schematics

Model **SANTOS 65** 45923

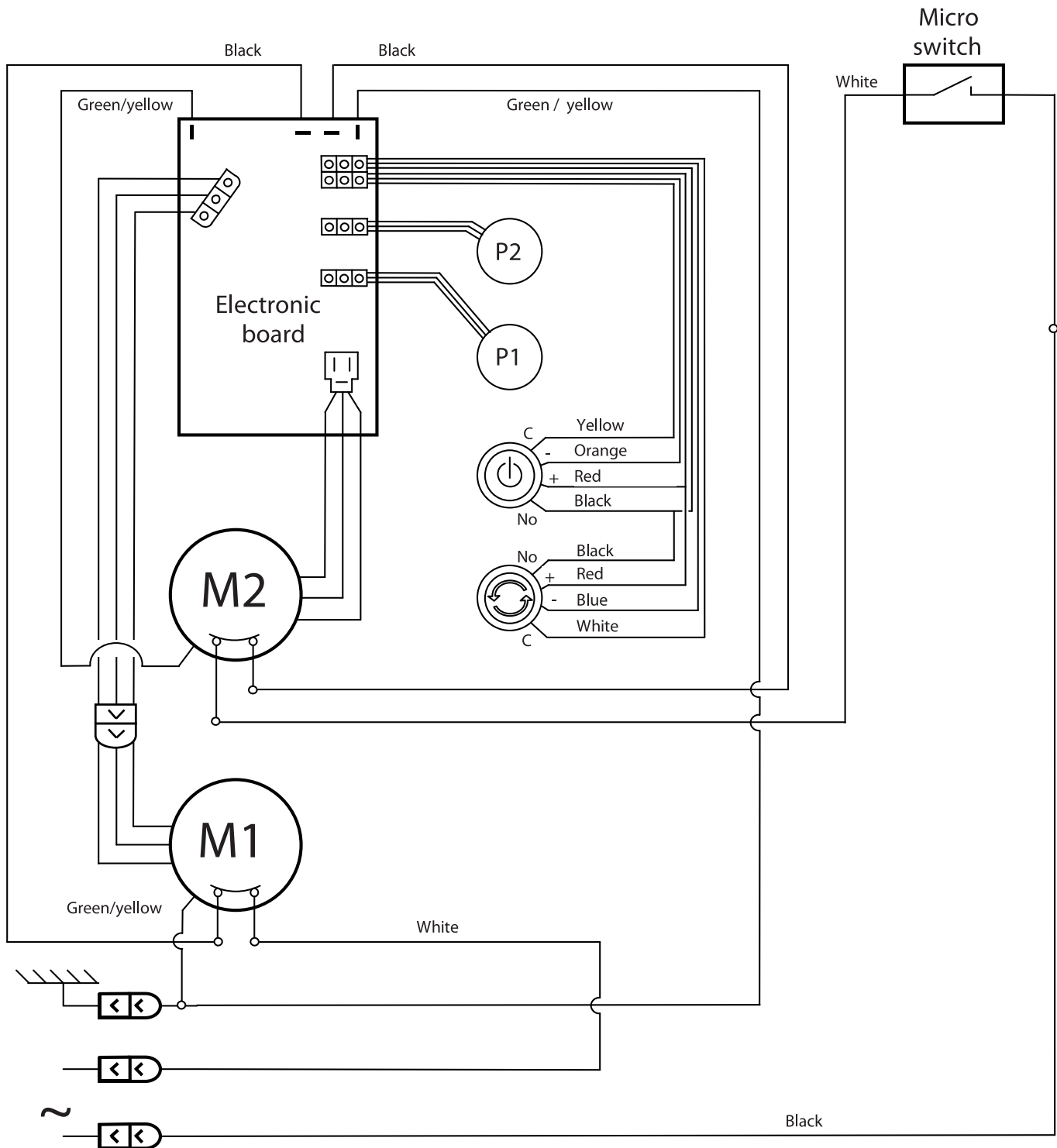



Warranty Registration

Thank you for purchasing an Omcan product. To register your warranty for this product, complete the information below, tear off the card at the perforation and then send to the address specified below. You can also register online by visiting:

Merci d'avoir acheté un produit Omcan. Pour enregistrer votre garantie pour ce produit, complétez les informations ci-dessous, détachez la carte au niveau de la perforation, puis l'envoyer à l'adresse spécifiée ci-dessous. Vous pouvez également vous inscrire en ligne en visitant:

Gracias por comprar un producto Omcan usted. Para registrar su garantía para este producto, complete la información a continuación, cortar la tarjeta en la perforación y luego enviarlo a la dirección indicada a continuación. También puede registrarse en línea en:

<https://omcan.com/warranty-registration/>

For mailing in Canada

Pour postale au Canada

Por correo en Canadá

OMCAN

PRODUCT WARRANTY REGISTRATION

3115 Pepper Mill Court,

Mississauga, Ontario

Canada, L5L 4X5

For mailing in the US

Pour diffusion aux États-Unis

Por correo en los EE.UU.

OMCAN

PRODUCT WARRANTY REGISTRATION

4450 Witmer Industrial Estates, Unit 4,

Niagara Falls, New York

USA, 14305

or email to: service@omcan.com



Purchaser's Information

Name: _____

Address: _____

City: _____ Province or State: _____ Postal or Zip: _____

Country: _____

Dealer from which Purchased: _____

Dealer City: _____ Dealer Province or State: _____

Invoice: _____

Model Name: _____ Model Number: _____

Machine Description: _____

Date of Purchase (MM/DD/YYYY): _____

Would you like to extend the warranty? Yes No

Company Name: _____

Telephone: _____

Email Address: _____

Type of Company:

Restaurant Bakery Deli

Butcher Supermarket Caterer

Institution (*specify*): _____

Other (*specify*): _____

Serial Number: _____

Date of Installation (MM/DD/YYYY): _____

Thank you for choosing Omcan | Merci d'avoir choisi Omcan | Gracias por elegir Omcan



Since 1951 Omcan has grown to become a leading distributor of equipment and supplies to the North American food service industry. Our success over these many years can be attributed to our commitment to strengthen and develop new and existing relationships with our valued customers and manufacturers. Today with partners in North America, Europe, Asia and South America, we continually work to improve and grow the company. We strive to offer customers exceptional value through our qualified local sales and service representatives who provide convenient access to over 5,000 globally sourced products.

Depuis 1951 Omcan a grandi pour devenir un des “leaders” de la distribution des équipements et matériel pour l’industrie des services alimentaires en Amérique du Nord. Notre succès au cours de ces nombreuses années peut être attribué à notre engagement à renforcer et à développer de nouvelles et existantes relations avec nos clients et les fabricants de valeur. Aujourd’hui avec des partenaires en Amérique du Nord, Europe, Asie et Amérique du Sud, nous travaillons continuellement à améliorer et développer l’entreprise. Nous nous efforçons d’offrir à nos clients une valeur exceptionnelle grâce à nos ventes locales qualifiées et des représentants de service qui offrent un accès facile à plus de 5000 produits provenant du monde entier.

Desde 1951 Omcan ha crecido hasta convertirse en un líder en la distribución de equipos y suministros de alimentos en América del Norte industria de servicios. Nuestro éxito en estos años se puede atribuir a nuestro compromiso de fortalecer y desarrollar nuevas relaciones existentes con nuestros valiosos clientes y fabricantes. Hoy con socios de América del Norte, Europa, Asia y América del Sur, que trabajan continuamente para mejorar y crecer la empresa. Nos esforzamos por ofrecer a nuestros clientes valor excepcional a través de nuestro local de ventas y representantes de los servicios que proporcionan un fácil acceso a más de 5,000 productos con origen a nivel mundial.

