

Parts Breakdown

Model SB-CN-0019 44248

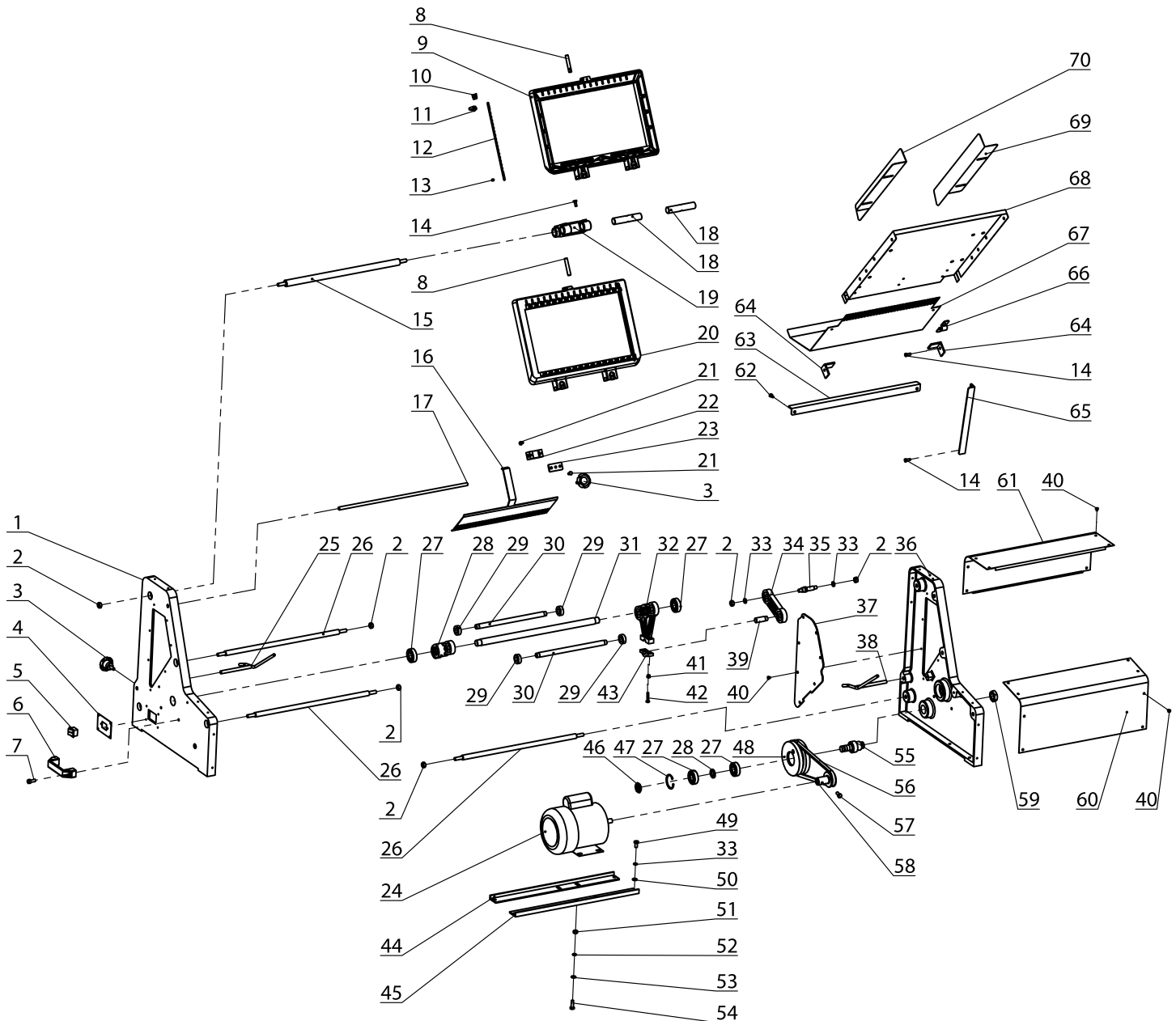

Parts Breakdown

Model SB-CN-0019 44248

Item No.	Description	Position	Item No.	Description	Position	Item No.	Description	Position
63586	Right Wall for 44248	1	63610	Lower Fixed Plate (Right) for 44248	25	63634	Screw M8x16 for 44248	49
63587	Nut M10 for 44248	2	63611	Frame Fixed Rod for 44248	26	63635	Washer Ø8 for 44248	50
63588	Handle for 44248	3	63612	Bearing 6204 for 44248	27	63636	Nut M8 for 44248	51
63589	Control Panel for 44248	4	63613	Plastic Base (Right) for 44248	28	63635	Washer Ø8 for 44248	52
63590	Power Switch for 44248	5	63614	Blade Frame Fixed Ring for 44248	29	63635	Washer Ø8 for 44248	53
63591	Plastic Handle for 44248	6	63615	Blade Frame Fixed Rod for 44248	30	63639	Screw M8x25 for 44248	54
63592	Screw M8x20 for 44248	7	63616	Blade Frame Fixed Rod for 44248	31	63640	Pulley Shaft for 44248	55
63593	Blade Frame Activity Lever for 44248	8	63617	Plastic Base (Left) for 44248	32	63641	Belt for 44248	56
64301	Upper Blade Frame for 44248	9	63618	Washer for 44248	33	63634	Screw M8x16 for 44248	57
63595	Spring for 44248	10	63619	Plastic Bearing Connecting Rod for 44248	34	63643	Motor Pulley Shaft for 44248	58
63596	Blade Frame Retainer for 44248	11	63620	Transmission Fixed Shaft for 44248	35	63644	Nut M22 for 44248	59
14836	Blade for 44248	12	63621	Left Wall for 44248	36	63645	Front Cover for 44248	60
63598	Blade Dowel for 44248	13	63622	Acrylic Board for 44248	37	63646	Upper Cover for 44248	61
63599	Screw M6x16 for 44248	14	63623	Lower Fixed Plate (Left) for 44248	38	63606	Screw M6x12 for 44248	62
63600	Fixed Rod for 44248	15	63624	Sliding Shaft for 44248	39	63648	Fixed Angle Iron for 44248	63
64302	Platen for 44248	16	63625	Screw M5x6 for 44248	40	63649	Fixed Angle Iron for 44248	64
63602	Fixed Rod for 44248	17	63626	Soft Hat M6 for 44248	41	63650	Fixed Angle Iron for 44248	65
63603	Upper Rod for 44248	18	63627	Screw M6x30 for 44248	42	63651	Sloping Plate Retainer for 44248	66
63604	Permanent Seat for 44248	19	63628	Plastic Base Attachment for 44248	43	64304	Tray Bar for 44248	67
64303	Lower Blade Frame for 44248	20	63629	Motor Support (Back) for 44248	44	63653	Sloping Plate for 44248	68
63606	Screw M6x12 for 44248	21	63630	Motor Support (Front) for 44248	45	63654	Width Fixing Plate for 44248	69
63607	Holder for 44248	22	63631	Nut M20 for 44248	46	63655	Width Fixing Plate for 44248	70
63608	Holder Cover for 44248	23	63632	Screw Ø49 for 44248	47	20860	Plastic Lock Bolt of Guides for 44248	
63609	Motor for 44248	24	63633	Pulley for 44248	48	63971	Complete Blade Assembly for 44248	