

Parts Breakdown

Model SB-CN-0025 44246

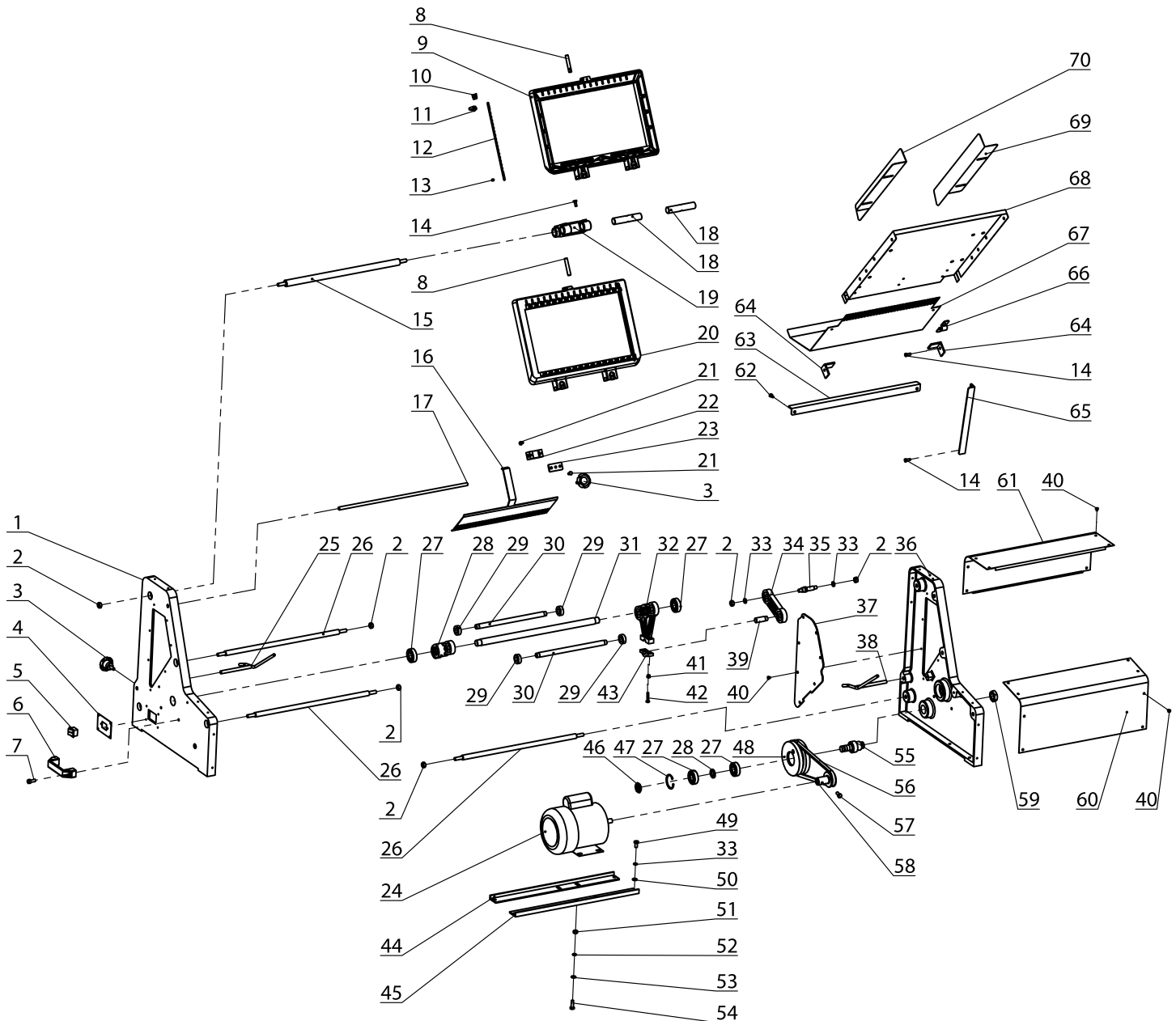

Parts Breakdown

Model SB-CN-0025 44246

Item No.	Description	Position	Item No.	Description	Position	Item No.	Description	Position
63586	Right Wall for 44246	1	63610	Lower Fixed Plate (Right) for 44246	25	63634	Screw M8x16 for 44246	49
63587	Nut M10 for 44246	2	63611	Frame Fixed Rod for 44246	26	63635	Washer Ø8 for 44246	50
63588	Handle for 44246	3	63612	Bearing 6204 for 44246	27	63636	Nut M8 for 44246	51
63589	Control Panel for 44246	4	63613	Plastic Base (Right) for 44246	28	63635	Washer Ø8 for 44246	52
63590	Power Switch for 44246	5	63614	Blade Frame Fixed Ring for 44246	29	63635	Washer Ø8 for 44246	53
63591	Plastic Handle for 44246	6	63615	Blade Frame Fixed Rod for 44246	30	63639	Screw M8x25 for 44246	54
63592	Screw M8x20 for 44246	7	63616	Blade Frame Fixed Rod for 44246	31	63640	Pulley Shaft for 44246	55
63593	Blade Frame Activity Lever for 44246	8	63617	Plastic Base (Left) for 44246	32	63641	Belt for 44246	56
63594	Upper Blade Frame for 44246	9	63618	Washer for 44246	33	63634	Screw M8x16 for 44246	57
63595	Spring for 44246	10	63619	Plastic Bearing Connecting Rod for 44246	34	63643	Motor Pulley Shaft for 44246	58
63596	Blade Frame Retainer for 44246	11	63620	Transmission Fixed Shaft for 44246	35	63644	Nut M22 for 44246	59
14836	Blade for 44246	12	63621	Left Wall for 44246	36	63645	Front Cover for 44246	60
63598	Blade Dowel for 44246	13	63622	Acrylic Board for 44246	37	63646	Upper Cover for 44246	61
63599	Screw M6x16 for 44246	14	63623	Lower Fixed Plate (Left) for 44246	38	63606	Screw M6x12 for 44246	62
63600	Fixed Rod for 44246	15	63624	Sliding Shaft for 44246	39	63648	Fixed Angle Iron for 44246	63
63601	Platen for 44246	16	63625	Screw M5x6 for 44246	40	63649	Fixed Angle Iron for 44246	64
63602	Fixed Rod for 44246	17	63626	Soft Hat M6 for 44246	41	63650	Fixed Angle Iron for 44246	65
63603	Upper Rod for 44246	18	63627	Screw M6x30 for 44246	42	63651	Sloping Plate Retainer for 44246	66
63604	Permanent Seat for 44246	19	63628	Plastic Base Attachment for 44246	43	63652	Tray Bar for 44246	67
63605	Lower Blade Frame for 44246	20	63629	Motor Support (Back) for 44246	44	63653	Sloping Plate for 44246	68
63606	Screw M6x12 for 44246	21	63630	Motor Support (Front) for 44246	45	63654	Width Fixing Plate for 44246	69
63607	Holder for 44246	22	63631	Nut M20 for 44246	46	63655	Width Fixing Plate for 44246	70
63608	Holder Cover for 44246	23	63632	Screw Ø49 for 44246	47	20860	Plastic Lock Bolt of Guides for 44246	
63609	Motor for 44246	24	63633	Pulley for 44246	48	63973	Complete Blade Assembly for 44246	