

Parts Breakdown

Model SE-CN-0358 14432

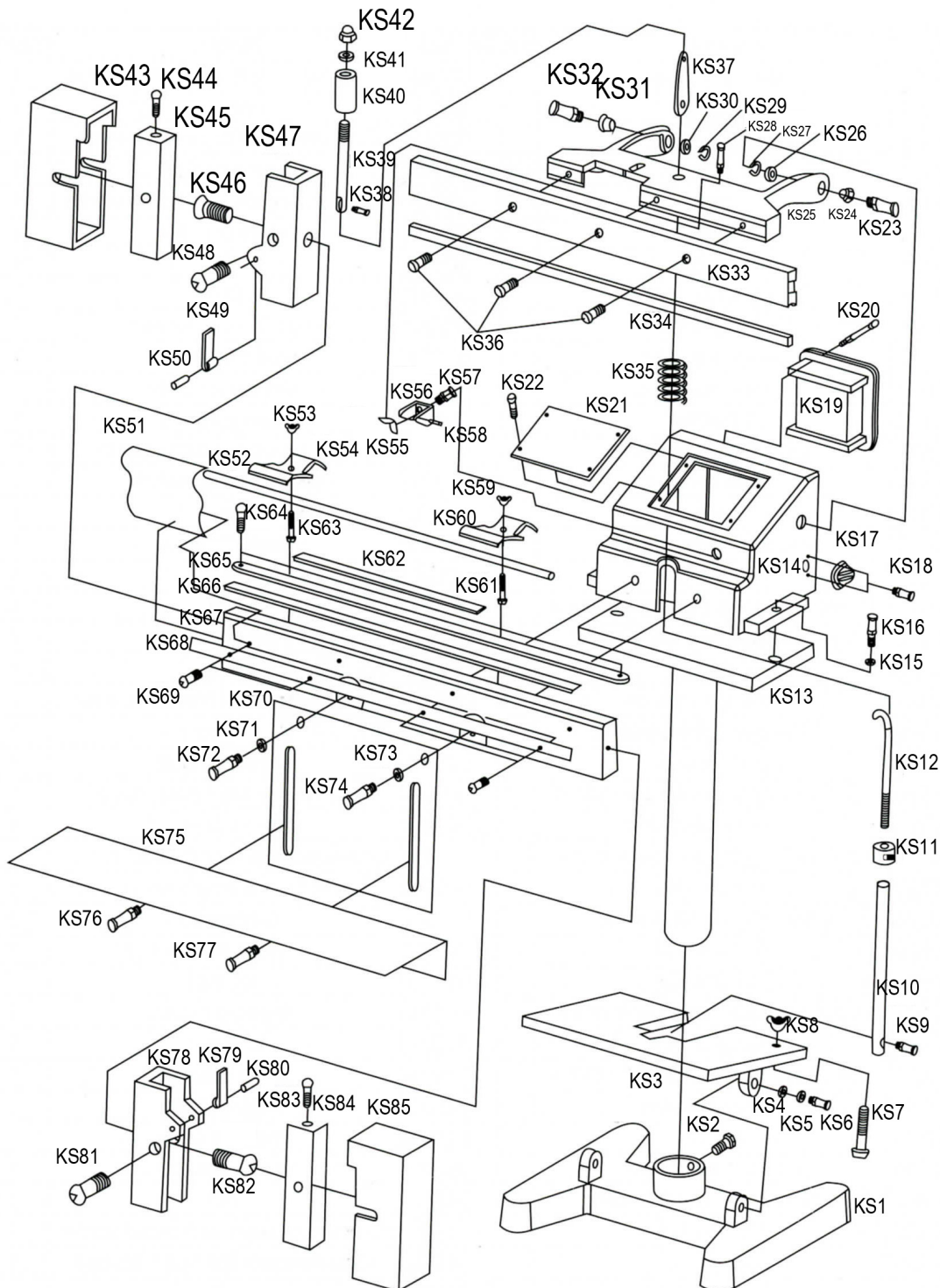

Parts Breakdown

Model SE-CN-0358 14432

Item No.	Description	Position	Item No.	Description	Position	Item No.	Description	Position
75287	Machine Base for 14432	KS1	75311	Upper Sealing Shelf for 14432	KS25	75341	Touching Board for 14432	KS55-56
75288	Bolt for 14432	KS2	75312	Tetrafluorohydrazine Convention for 14432	KS26	75342	Switch Shelf for 14432	KS57-58
75289	Pedal Board for 14432	KS3	75313	Flexible Mat for 14432	KS27	75345	Butterfly Nuts for 14432	KS59
75290	Flat Washer for 14432	KS4	75314	Inner Hex Screw and Nut for 14432	KS28	75346	Pressor for 14432	KS60
75291	Nut for 14432	KS5	75315	Flexible Mat for 14432	KS29	75347	Bolt for 14432	KS61
75292	Bolt for 14432	KS6	75316	Flat Washer for 14432	KS30	75348	Insulated Pad for 14432	KS62
75293	Adjusting Bolt for 14432	KS7	75317	Tetrafluorohydrazine Convention for 14432	KS31	75349	Bolt for 14432	KS63
75294	Butterfly Nut for 14432	KS8	75318	Bolt Groups for 14432	KS32	75350	Countersink Flat Head Screws for 14432	KS64
75295	Bolt Groups for 14432	KS9	75319	Upper Sealing Silicon Fasten Block for 14432	KS33	75351	Heater for 14432	KS65
75296	Pedal Board Tie for 14432	KS10	17737	Silicon Rubber for 14432	KS34	75352	Insulated Pad for 14432	KS66
75297	Connecting Nut for 14432	KS11	75321	Spring for 14432	KS35	75353	Lower Sealing Fasten Base for 14432	KS67
75298	Coupling Tie for 14432	KS12	75322	Inner Hex Screw and Nut for 14432	KS36	75354	Polymer Pressor for 14432	KS68
75299	Upright Column Base for 14432	KS13	75323	Small Connecting Board for 14432	KS37	75355	Cross Recessed Pan Head Screw for 14432	KS69
75300	Machine Cover for 14432	KS14	75324	Flexible Pin for 14432	KS38	75356	Fasten Board of Working Table for 14432	KS70
75301	Nut for 14432	KS15	75325	Tie for 14432	KS39	75357	Flat Cushion for 14432	KS71
75302	Screw and Flat Gasket for 14432	KS16	75326	Rubber Cushion for 14432	KS40	75358	Bolts Groups for 14432	KS72
75303	Wire Guider for 14432	KS17	75327	Washer for 14432	KS41	75359	Flat Mat for 14432	KS73
75304	Cross Recessed Pan Head Screw for 14432	KS18	75328	Cap Nuts for 14432	KS42	75360	Bolts Groups for 14432	KS74
75305	Transformers and Back Cover for 14432	KS19	75329	Plastic Cover for 14432	KS43	75361	Flat Mat for 14432	KS75
75306	Bolt for 14432	KS20	75364	Ceramic Base for 14432	KS44-50	75358	Bolt Groups for 14432	KS76
75307	Operation Panel for 14432	KS21	75337	Polymer for 14432	KS51	75360	Bolt Groups for 14432	KS77
75308	Countersink Screw for 14432	KS22	75338	Axles for Polymer for 14432	KS52	75364	Ceramic Base for 14432	KS78-84
75309	Bolt Groups for 14432	KS23	75339	Butterfly Nut for 14432	KS53	75329	Plastic Cover for 14432	KS85
75310	Tetrafluorohydrazine Convention for 14432	KS24	75340	Hold-Down Plate for 14432	KS54	72308	Screw and Pin Assembly for 14432	