



Vacuum Packaging Machines

Models VP-CN-0749, 1066, 0500
Items 19481, 19482, 44594
Instruction Manual



STOP
DO NOT RETURN
THIS PRODUCT TO THE STORE

For questions or assistance with this product call OMCAN Toll Free:
1 800 465 0234
Customer Service
or
visit the Support section of
www.omcan.com

Revised - 01/20/2020



Toll Free: 1-800-465-0234
Fax: 905-607-0234
Email: service@omcan.com
www.omcan.com

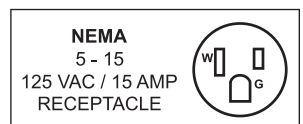

Table of Contents

Model VP-CN-0749 / Model VP-CN-1066 / Model VP-CN-0500

Section	Page
General Information -----	3 - 4
Safety and Warranty -----	4 - 5
Technical Specifications -----	6
Installation -----	6 - 7
Operation -----	7 - 8
Maintenance -----	8 - 11
Troubleshooting -----	12
Parts Breakdown -----	13 - 14
Electrical Schematics -----	15
Notes -----	16 - 18
Warranty Registration -----	19



General Information

Omcan Manufacturing and Distributing Company Inc., Food Machinery of America, Inc. dba Omcan and Omcan Inc. are not responsible for any harm or injury caused due to any person's improper or negligent use of this equipment. The product shall only be operated by someone over the age of 18, of sound mind, and not under the influence of any drugs or alcohol, who has been trained in the correct operation of this machine, and is wearing authorized, proper safety clothing. Any modification to the machine voids any warranty, and may cause harm to individuals using the machine or in the vicinity of the machine while in operation.

CHECK PACKAGE UPON ARRIVAL

Upon receipt of an Omcan shipment please inspect for external damage. If no damage is evident on the external packaging, open carton to ensure all ordered items are within the box, and there is no concealed damage to the machine. If the package has suffered rough handling, bumps or damage (visible or concealed), please note it on the bill of lading before accepting the delivery and contact Omcan within 24 hours, so we may initiate a claim with the carrier. A detailed report on the extent of the damage caused to the machine must be filled out within three days, from the delivery date shown in the shipping documents. Omcan has no recourse for damaged products that were shipped collect or third party.

Before operating any equipment, always read and familiarize yourself with all operation and safety instructions.

Omcan would like to thank you for purchasing this machine. It's of the utmost importance to save these instructions for future reference. Also save the original box and packaging for shipping the equipment if servicing or returning of the machine is required.

Omcan Fabrication et distribution Compañie Limité et Food Machinery d'Amerique, dba Omcan et Omcan Inc. ne sont pas responsables de tout dommage ou blessure causé du fait que toute personne ait utilisé cet équipement de façon irrégulière. Le produit ne doit être exploité que par quelqu'un de plus de 18 ans, saine d'esprit, et pas sous l'influence d'une drogue ou d'acohol, qui a été formé pour utiliser cette machine correctement, et est vêtu de vêtements de sécurité approprié. Toute modification de la machine annule toute garantie, et peut causer un préjudice à des personnes utilisant la machine ou des personnes à proximité de la machine pendant son fonctionnement.

VÉRIFIEZ LE COLIS DÈS RÉCEPTION

Dès réception d'une expédition d'Omcan veuillez inspecter pour dommages externes. Si aucun dommage n'est visible sur l'emballage externe, ouvrez le carton afin de s'assurer que tous les éléments commandés sont dans la boîte, et il n'y a aucun dommage dissimulé à la machine. Si le colis n'a subi aucune mauvaises manipulations, de bosses ou de dommages (visible ou cachée), notez-le sur le bond de livraison avant d'accepter la livraison et contactez Omcan dans les 24 heures qui suivent, pour que nous puissions engager une réclamation auprès du transporteur. Un rapport détaillé sur l'étendue des dommages causés à la machine doit être rempli dans un délai de trois jours, à compter de la date de livraison indiquée dans les documents d'expédition. Omcan n'a aucun droit de recours pour les produits endommagés qui ont été expédiées ou cueilli par un tiers transporteur.

General Information

Avant d'utiliser n'importe quel équipement, toujours lire et vous familiariser avec toutes les opérations et les consignes de sécurité.

Omcan voudrais vous remercier d'avoir choisi cette machine. Il est primordial de conserver ces instructions pour une référence ultérieure. Également conservez la boîte originale et l'emballage pour l'expédition de l'équipement si l'entretien ou le retour de la machine est nécessaire.

Omcan Empresa De Fabricacion Y Distribucion Inc. Y Maquinaria De Alimentos De America, Inc. dba Omcan y Omcan Inc. no son responsables de ningun daño o perjuicio causado por cualquier persona inadecuada o el uso descuidado de este equipo. El producto solo podra ser operado por una persona mayor de 18 años, en su sano juicio y no bajo alguna influencia de droga o alcohol, y que este ha sido entrenado en el correcto funcionamiento de esta máquina, y ésta usando ropa apropiada y autorizada. Cualquier modificación a la máquina anula la garantía y puede causar daños a las personas usando la máquina mientras esta en el funcionamiento.

REVISE EL PAQUETE A SU LLEGADA

Tras la recepcion de un envio Omcan favor inspeccionar daños externos. Si no hay daños evidentes en el empaque exterior, Habra el carton para asegurarse que todos los articulos solicitados estén dentro de la caja y no encuentre daños ocultos en la máquina. Si el paquete ha sufrido un manejo de poco cuidado, golpes o daños (visible o oculto) por favor anote en la factura antes de aceptar la entrega y contacte Omcan dentro de las 24 horas, de modo que podamos iniciar una reclamación con la compañía. Un informe detallado sobre los daños causados a la máquina debe ser llenado en el plazo de tres días, desde la fecha de entrega que se muestra en los documentos de envío. Omcan no tiene ningun recurso por productos dañados que se enviaron a recoger por terceros.

Antes de utilizar cualquier equipo, siempre leer y familiarizarse con todas las instrucciones de operación y seguridad.

Omcan quisiera darles las gracias por la compra de esta máquina. Es de la máxima importancia para guardar estas instrucciones para referencias en el futuro. También guarde la caja original y el embalaje para envío del equipo si el mantenimiento o la devolución de la máquina es necesaria.

Safety and Warranty

GENERAL SAFETY REGULATIONS

These vacuum packaging machines are capable of: easy operation, easy maintenance, user friendly and also to cope with wide range application. Especially suitable for soft packing material such as complex film, aluminum-foil complex film etc. It can also pack products in vacuum form or inserting gas after vacuum form to solid, powder and even liquid, paste, seed, fragrant article, medicine, chemical, electronic, precision instrument, meter and rare expensive metal etc.



Safety and Warranty

The machine must be used only by suitably trained personnel. Furthermore, this personnel must have read this manual carefully. In particular, please comply to the following instructions:

- This machine is user friendly. Close the machine cover, air exhaustion (vacuum), gas filling, heating, sealing, label printing, cooling, return-air, to the re-opening of cover, the whole processing is done automatically.
- The sealing temperature and sealing time can be set flexibly with a wide adjustable range so as to suit various packing bags with different materials and specifications.
- This machine is equipped with safe grounding protection and E-Stop Button protection to deal with sudden accident. The E-Stop Button can be pressed to stop packing procedure immediately if there is any emergency arise during processing.
- The articles packed in vacuum condition ensure to the quality and freshness for a longer period as it can prevent oxidation, mildew, moth, rotten and damp, vacuum machine have different working environment.

1 YEAR PARTS AND LABOR BENCH WARRANTY

Within the warranty period, contact Omcan Inc. at 1-800-465-0234 to schedule a drop off to either an Omcan authorized service depot in the area, or to an Omcan Service warehouse to repair the equipment.

Unauthorized maintenance will void the warranty. Warranty covers electrical and part failures, not improper use.

Please see <https://omcan.com/disclaimer> for complete info.

WARNING:

The packaging components are classified as normal solid urban waste and can therefore be disposed of without difficulty.

In any case, for suitable recycling, we suggest disposing of the products separately (differentiated waste) according to the current norms.

DO NOT DISCARD ANY PACKAGING MATERIALS IN THE ENVIRONMENT!

Technical Specifications

Model	VP-CN-0749	VP-CN-1066	VP-CN-0500
Power	0.5 HP / 0.37 kW	1.2 HP / 0.9 kW	1 HP / 0.75 kW
Seal Bar	10.2" x 0.31" / 259 x 8mm	15.4" x 0.31" / 391 x 8mm	20.5" x 0.31" / 520 x 8mm
Cycle Time	30 seconds	23 - 25 seconds	30 - 60 seconds
Pump Power	10 m ³ /h	20 m ³ /h	
Chamber Size	15.25" x 11" x 3.25" 387 x 279 x 83mm	19.75" x 16.25" x 4.5" 502 x 413 x 114mm	21.3" x 20.5" x 8.3" 541 x 521 x 211mm
Electrical	110V / 60Hz / 1		
Dimensions	19" x 13" x 12.6" 483 x 330 x 320mm	24" x 18.5" x 20.5" 610 x 470 x 521mm	26.6" x 23.2" x 20.1" 675 x 590 x 510mm
Weight	79.2 lbs. / 35.9 kgs.	96.8 lbs. / 43.9 kgs.	191.8 lbs. / 87 kgs.
Item Number	19481	19482	44594

Omcans carries all size of vacuum packaging bags for the above models.

Installation

PREPARATION BEFORE USE

1. Before operation, please read through the user guide about each operation rule and safety precaution.
2. You must fill the vacuum pump with pump oil before use (when the machine is placed at a horizontal position, the oil should be kept at 1/3-1/2 in the oil window). When running, the oil level should not be lower than 1/3 in the oil window. Do not fill with too much oil to avoid overflow.
3. The machine should be placed horizontally in a well ventilated and lit space, free from corrosive gas and heavy dust.
4. Make sure that the machine is properly grounded before use.
5. Always ensure top cover is open before turning the power on. Start the machine by closing the top cover and the process will start automatically.
6. Preheat of vacuum pump must be done in low temperature working area. Turn off the heater selection switch at the control panel to off position. This is to prevent heating process and cut down wear and tear on the unit.

Tip: In order to quickly process a small item or product using a bigger chamber is to place a solid block into the chamber in order to occupy the chamber space so as to allow less vacuum time needed.

Note: Do not block the air hole in the chamber.

SETTING

Please set every parameter first before starting the machine.

1. Turn on the power supply, check through the setting shows on the panel and make sure "----" must be shown after setting is done. Otherwise, operation of this machine cannot be function if the setting is not on

Installation

this mode.

2. Press the setting button, the indicator lamp of vacuum lights to enter into the setting state of vacuum timing. Press the upward or downward key to increase or decrease vacuum time in the range of 0-99 seconds.
3. After the vacuum time is set, press the set key and the nitrogen filling indicator lamp lights to enter into the setting state of nitrogen filling. Press the upward or downward key to increase or decrease nitrogen filling time in the range of 0-99 seconds.

Note: Some models of our machine do not have nitrogen filling function, So after setting the vacuum time, it enter sealing time directly.

4. Press the setting button, heating indicator lamp lights to enter into heating setting state. Press the upward or downward key to increase or decrease the heating sealing time in the range of 0-3.5 seconds. The time setting should be from low timing and gradually to higher timings.
5. After the heating time is set, press the set key again, cooling indicator lamp lights to enter into the setting state of cooling time in the range of 0-9.9 seconds.
6. After the cooling time is set, press the set key again to finish the parameter setting, and “Ed” is shown in panel.
Press the “temperature selection” set key to enter into temperature set state. Press the set key once, indicate one corresponding temperature value, and the lamp shows orange color; there are three selections such as “high temperature”, “middle temperature” and “low temperature”. For a special requirement, please contact the equipment manufacturer.

Operation

1. Turn on the power supply and select a suitable vacuum packing bag for the product.
2. Set the processing parameter and select the sealing temperature. Please refer to the Installation section.
3. Place the vacuum bag at the chamber with the opening end on top of the sealing bar. Clamp it with the hook provided.
4. Close the acrylic cover and the machine will complete the processing procedure automatically.
5. During processing, the vacuum chamber will form a vacuum self-lock state, the whole heating and sealing procedure are completed in a vacuum environment, and the LED display on panel shows the flow process.
6. When the vacuum indicator on panel lights, the equipment is under vacuum state, the LED display shows the timing of vacuum time, and it will enter into the next work state automatically after the timing is finished.
7. When the nitrogen filling indicator on panel lights, the equipment is under filling state, the LED display shows the reverse timing of filling time, and it will enter into the next work state automatically after the reverse timing is finished.
8. When heating indicator lights, the equipment enters into heating work state, and the panel shows the reverse timing of heating. It will enter into cooling state automatically after the timing is finished.
9. According to time setting, the machine doesn't act when cooling, the panel shows “□□” till the reverse timing is finished, air is returned, the cover opens automatically, and the whole processing is finished. Then prepare the next cycle.
10. Press the E-Stop Button for a sudden condition under processing state, the machine will go to return-air action automatically, the cover opens automatically after return-air action, so the processing ends.

Operation

NOTES:

- Silicone rubber strip come with one side nerving and the other for letter and number inserting. It will have embossed effect on sealing surface.
- Please do not run the machine without any vacuum bag attach. Otherwise, the heating element will have higher wear and tear.
- Cut off the power supply and pull out external plug when no use.
- The vacuum gauge/meter reading may be different due to different area. At high altitudes, the data in vacuum meter goes down.
- Please adopt suitable cooling measure when processing is done in a high temperature occasion.
- Please use the vacuum bag whose material does not bring any poisonous gas in the sealing.
- The machine should be placed horizontally in the transportation, the inversion is not allowed. The transportation must be proceeded strictly according to the instructing marks on the shipping case.
- The machine should be stored in dry, ventilated, normal temperature place.
- Mind your head when the lid open, and avoid the lid striking your head.
- Please ask a professional to solve the problem. Do not do some repair works by yourself.
- The spare parts should match our machine in the replacement.

Maintenance

SEALING TAPE AND HEATING WIRE REPLACEMENT



1. Disconnect the cable from the pin, then pick the complete sealing bar up from the vacuum chamber.

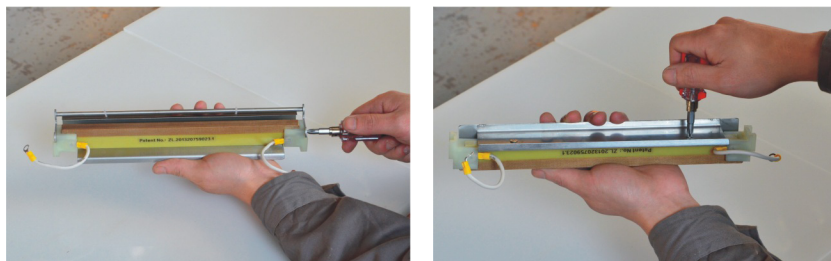

2. Remove the pressing stick from the complete sealing bar by cross screwdriver, then remove the stainless steel base (gas bag base).

Maintenance

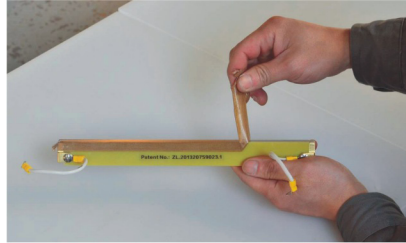

3. Pull the plastic parts out from the two sides of sealing bar by hand, then tear off the sealing tape.



4. Remove the forcing screws from the two sides of sealing bar by Allen key, then take out the heating wire.

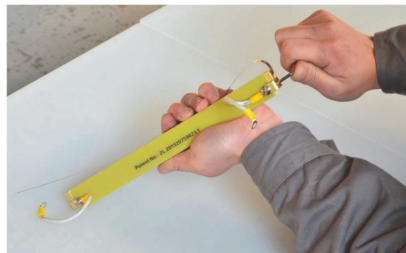
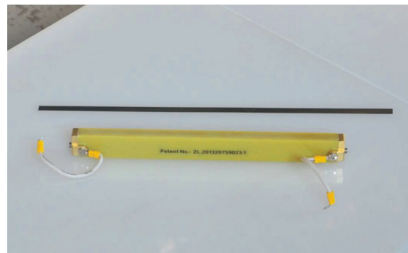

5. Put one side of a new heating wire into the fastener groove and tighten it by spanner.



6. Put the other side of heating wire into another side fastener groove, then screw the remaining heating wire by the special tool.

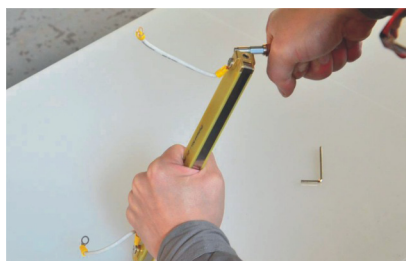
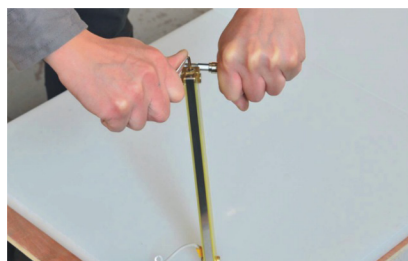

7. Fasten the heating wire by Allen key, then cut the remaining heating wire by the special tool.

Maintenance

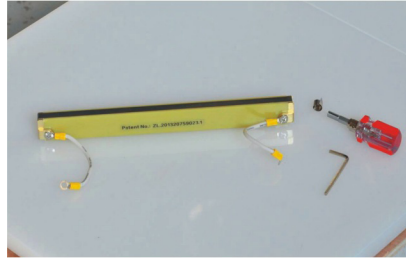

8. Take a sealing tape at proper length and sticker it on the heating wire.

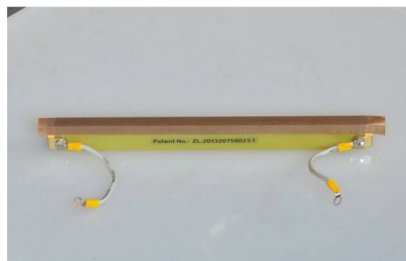

9. Cut the remaining sealing tape on the two sides enable to fold it.

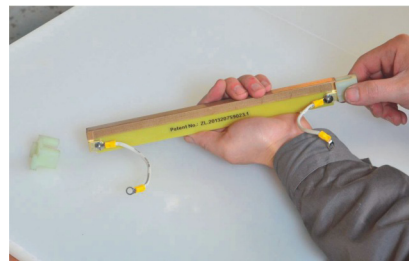

10. Put plastic parts on the two sides of sealing bar.

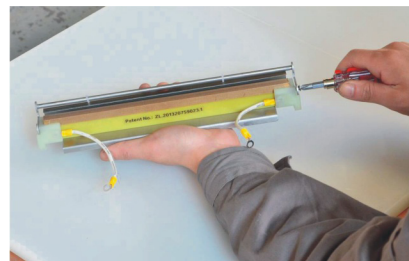
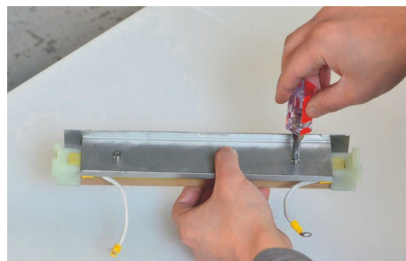

11. Install the stainless steel base and pressing stick.



12. Connect the cable of complete sealing bar to the pin, then put the sealing bar back to vacuum chamber to finish the installation.

FILLING THE OIL

Note: Only perform this procedure on a flat, stable surface.

1. Unscrew the side board by removing the single screw at the bottom middle of the side board.
2. Lift the casing until the inside of the unit is revealed (the hinge will stop the casing from falling).
3. Check the oil level:
 - Ensure that the oil level is at least between 1/2 to 3/4 full.

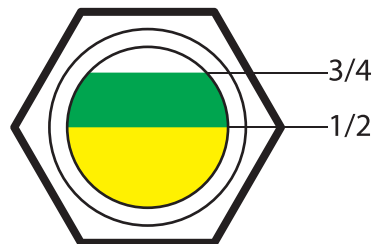

4. Unscrew the oil drain and remove the old oil.
5. Screw the oil drain back on, then unscrew the Refueling cap and fill the oil to the necessary amount. Seal the cap.



6. Close the unit by following steps 1 and 2 in reverse order.

NOTES

- It is recommended to replace the oil every 120 hours.
- It is recommended to replace the oil when the vacuum pump is still warm from use.

Troubleshooting

Problem	Possible Solutions
Vacuum pump does not work.	Limit switch is not pressed on, close the machine cover and adjust the limit switch.
	Limit switch is broken, replace it.
	Contactors are broken, replace it.
	Pump motor is broken, replace it.
Vacuum chamber cannot reach the vacuum degree.	The vacuum pump is worn or damaged.
	Loose air pipe joint, broken pip, damaged sealing ring of vacuum chamber or damaged valve causes the entry of air into vacuum chamber.
	Insufficient oil in vacuum pump.
	Vacuum time is not enough.
Cover cannot be opened.	Air release valve is not turned on.
Air remains in bag after processing is finished.	Wrong position resting on seal bar.
	Pressing stick press the bag opening side causes the air cannot be sucked.
Abnormal sound or tripping when running, black smoke or oil drop.	Abnormal sound of fan of pump motor, it should be repaired.
	Blockage may be seen in air intake and/or pip.
	Insufficient oil of vacuum pump or the use of non-standard oil.
	Long time running of pump or overheat running under high temperature.
	Faulty vacuum pump motor or valve of vacuum pump or wear and tear due to usage.

REFERENCE

Item Number	Model Number	Description	Manufacturer Model Number
19481	VP-CN-0749	Vacuum Packaging Machine 15.25" x 11" x 3.25"/387 x 279 x 83mm Chamber Size 110V / 60 / 1 cMETus	260/PD
19482	VP-CN-1066	Vacuum Packaging Machine 19.75" x 16.25" x 4.5"/502 x 413 x 114mm Chamber Size 110V / 60 / 1 cMETus	390/T
44594	VP-CN-0500	Vacuum Packaging Machine 21.3" x 20.5" x 8.3"/541 x 521 x 211mm Chamber Size 110V / 60 / 1 cMETus	500/T

Parts Breakdown

Model VP-CN-0749 19481

Model VP-CN-1066 19482

Model VP-CN-0500 44594

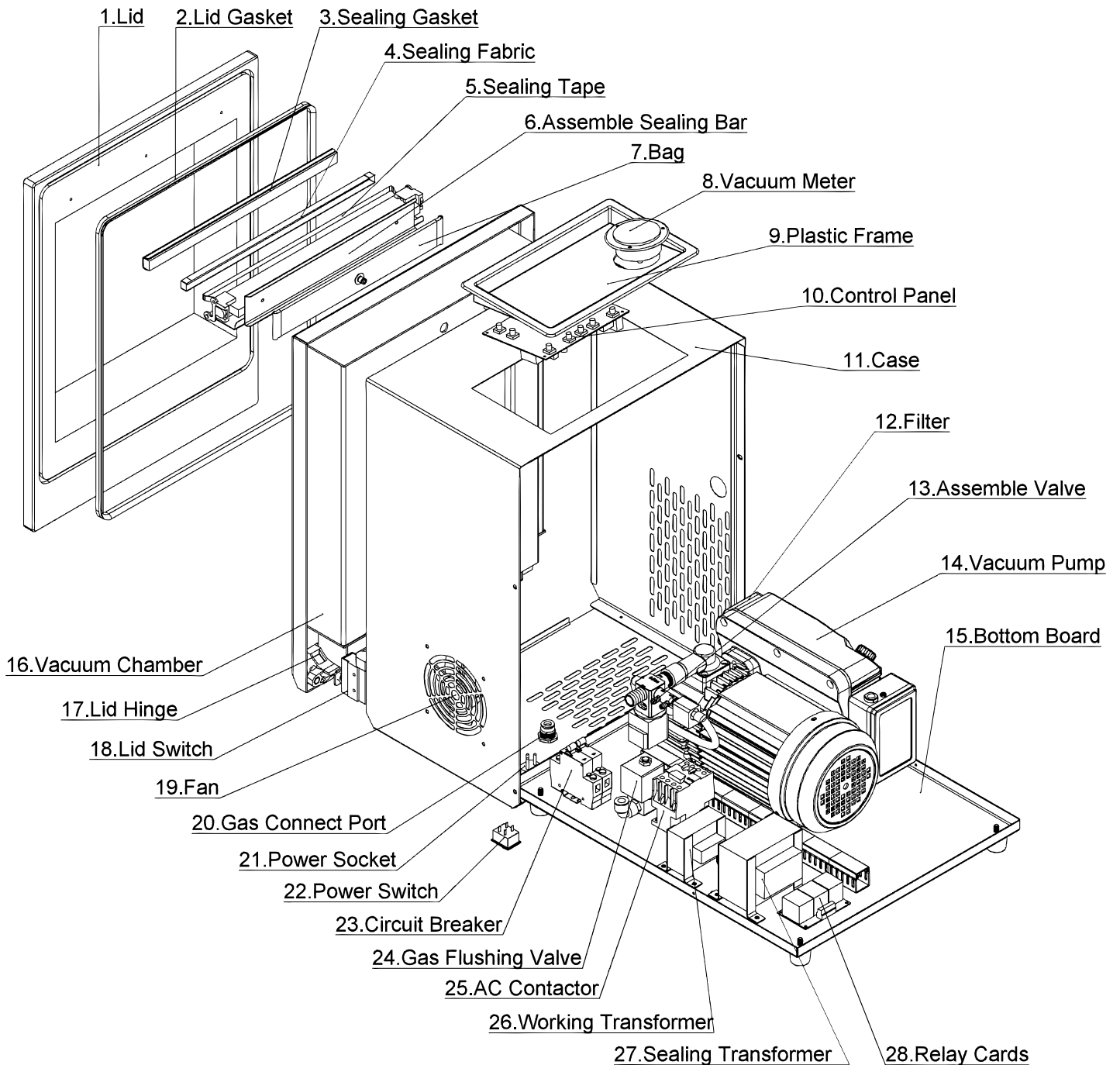

Parts Breakdown

Model VP-CN-0749 19481

Item No.	Description	Position	Item No.	Description	Position	Item No.	Description	Position
67581	Lid for 260/PD	1	67590	Control Panel for 260/PD	10	67599	Power Switch for 260/PD	22
67582	Lid Gasket for 260/PD	2	67591	Filter for 260/PD	12	67600	Gas Flushing Valve for 260/PD	23
67583	Sealing Gasket for 260/PD	3	67592	Assemble Valve for 260/PD	13	67601	Circuit Breaker for 260/PD	24
67584	Sealing Fabric (10M/Roll) for 260/PD	4	67593	Vacuum Pump for 260/PD	14	67602	Relay Cards for 260/PD	25
67585	Sealing Tape for 260/PD	5	67594	Lid Hinge for 260/PD	17	67603	Working Transformer for 260/PD	26
14977	Complete Sealer for 260/PD	6	67595	Lid Switch for 260/PD	18	67604	Sealing Transformer for 260/PD	27
67587	Gas Bag for 260/PD	7	67596	Fan for 260/PD	19	67605	PP Plate for 260/PD	28
67588	Vacuum Meter for 260/PD	8	67597	Gas Connect Port for 260/PD	20			
67589	Plastic Frame for 260/PD	9	67598	Power Socket for 260/PD	21			

Model VP-CN-1066 19482

Item No.	Description	Position	Item No.	Description	Position	Item No.	Description	Position
67606	Lid for 390/T	1	67615	Control Panel for 390/T	10	67624	Power Switch for 390/T	22
67607	Lid Gasket for 390/T	2	67616	Filter for 390/T	12	67625	Gas Flushing Valve for 390/T	23
67608	Sealing Gasket for 390/T	3	67617	Assemble Valve for 390/T	13	67626	Circuit Breaker for 390/T	24
67609	Sealing Fabric (10M/Roll) for 390/T	4	67618	Vacuum Pump for 390/T	14	67627	Relay Cards for 390/T	25
67610	Sealing Tape for 390/T	5	67619	Lid Hinge for 390/T	17	67628	Working Transformer for 390/T	26
67611	Assemble Sealing Bar for 390/T	6	67620	Lid Switch for 390/T	18	67629	Sealing Transformer for 390/T	27
67612	Gas Bag for 390/T	7	67621	Fan for 390/T	19	67630	PP Plate for 390/T	28
67613	Vacuum Meter for 390/T	8	67622	Gas Connect Port for 390/T	20			
67614	Plastic Frame for 390/T	9	67623	Power Socket for 390/T	21			

Model VP-CN-0500 44594

Item No.	Description	Position	Item No.	Description	Position	Item No.	Description	Position
69953	Lid for 500/T	1	67590	Control Panel for 500/T	10	67599	Power Switch for 500/T	22
67582	Lid Gasket for 500/T	2	69957	Filter for 500/T	12	67600	Gas Flushing Valve for 500/T	23
69954	Sealing Gasket for 500/T	3	69958	Assemble Valve for 500/T	13	67601	Circuit Breaker for 500/T	24
67584	Sealing Fabric for 500/T	4	69959	Vacuum Pump for 500/T	14	69963	Relay Cards for 500/T	25
67585	Sealing Tape for 500/T	5	67594	Lid Hinge for 500/T	17	69961	Working Transformer for 500/T	26
69955	Assemble Sealing Bar for 500/T	6	67595	Lid Switch for 500/T	18	69962	Sealing Transformer for 500/T	27
69956	Gas Bag for 500/T	7	67596	Fan for 500/T	19	69964	PP Plate for 500/T	28
67588	Vacuum Meter for 500/T	8	67597	Gas Connect Port for 500/T	20			
67589	Plastic Frame for 500/T	9	67598	Power Socket for 500/T	21			

Electrical Schematics

Model VP-CN-0749 19481

Model VP-CN-1066 19482

Model VP-CN-0500 44594

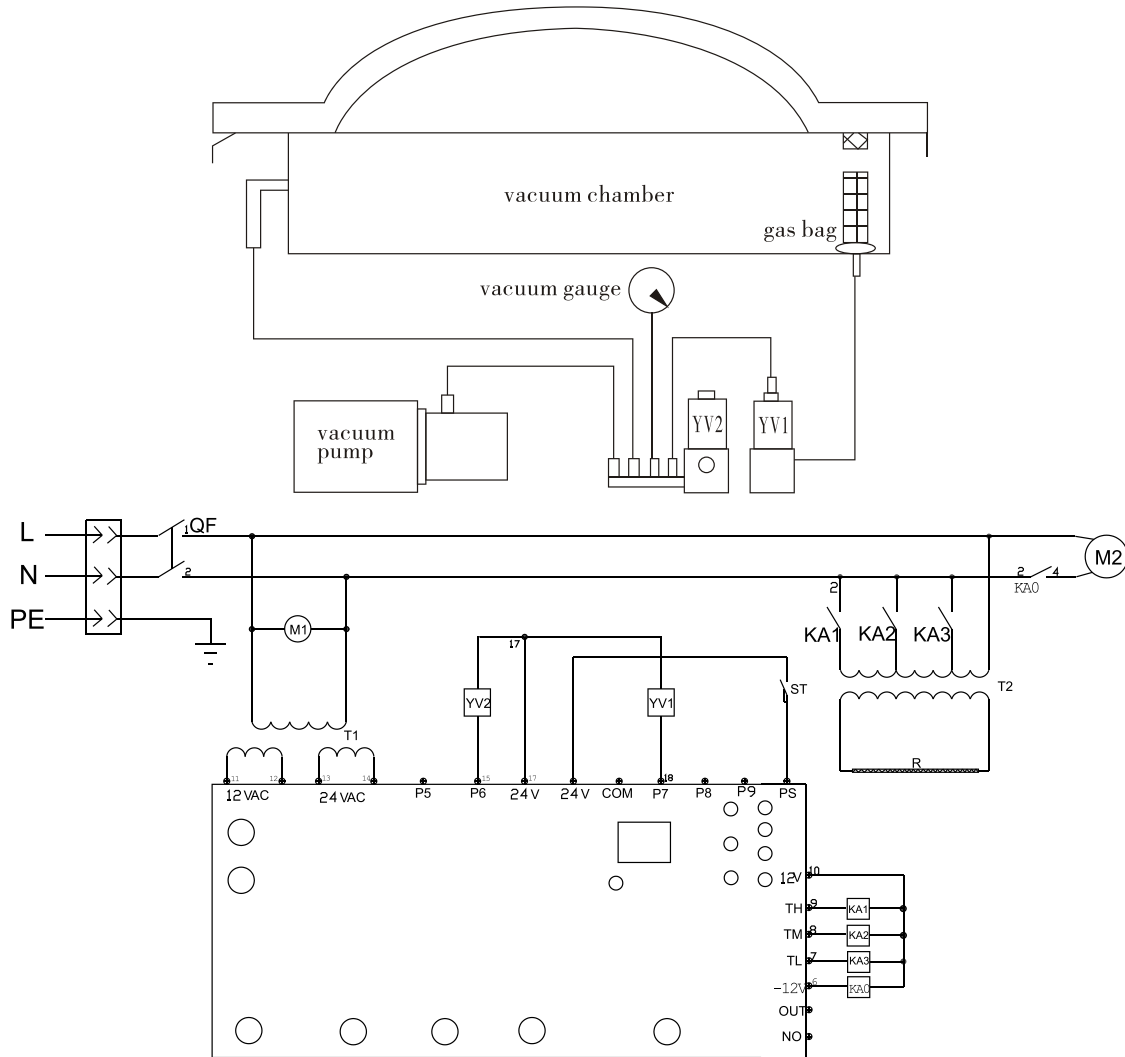

Code	Description	Code	Description
KA0~3	Four in One Relay	R	Heating Wire (R1-2)
KA1~3	Three in One Relay	ST	Lid Switch (Travel Switch)
KM	Contactora	T1	Working Transformer
KM1	Contactora	T2	Sealing Transformer
M1	Radiator Fan	YV1	Sealing Valve
M2	Pump Motor	YV2	Air Release Valve
QF	Power Switch		



Warranty Registration

Thank you for purchasing an Omcan product. To register your warranty for this product, complete the information below, tear off the card at the perforation and then send to the address specified below. You can also register online by visiting:

Merci d'avoir acheté un produit Omcan. Pour enregistrer votre garantie pour ce produit, complétez les informations ci-dessous, détachez la carte au niveau de la perforation, puis l'envoyer à l'adresse spécifiée ci-dessous. Vous pouvez également vous inscrire en ligne en visitant:

Gracias por comprar un producto Omcan usted. Para registrar su garantía para este producto, complete la información a continuación, cortar la tarjeta en la perforación y luego enviarlo a la dirección indicada a continuación. También puede registrarse en línea en:

<https://omcan.com/warranty-registration/>

For mailing in Canada

Pour postale au Canada

Por correo en Canadá

OMCAN

PRODUCT WARRANTY REGISTRATION

3115 Pepper Mill Court,

Mississauga, Ontario

Canada, L5L 4X5

For mailing in the US

Pour diffusion aux États-Unis

Por correo en los EE.UU.

OMCAN

PRODUCT WARRANTY REGISTRATION

4450 Witmer Industrial Estates, Unit 4,

Niagara Falls, New York

USA, 14305

or email to: service@omcan.com



Purchaser's Information

Name: _____

Address: _____

City: _____ Province or State: _____ Postal or Zip: _____

Country: _____

Dealer from which Purchased: _____

Dealer City: _____ Dealer Province or State: _____

Invoice: _____

Model Name: _____ Model Number: _____

Machine Description: _____

Date of Purchase (MM/DD/YYYY): _____

Would you like to extend the warranty? Yes No

Company Name: _____

Telephone: _____

Email Address: _____

Type of Company:

Restaurant Bakery Deli

Butcher Supermarket Caterer

Institution (specify): _____

Other (specify): _____

Serial Number: _____

Date of Installation (MM/DD/YYYY): _____

Thank you for choosing Omcan | Merci d'avoir choisi Omcan | Gracias por elegir Omcan



Since 1951 Omcan has grown to become a leading distributor of equipment and supplies to the North American food service industry. Our success over these many years can be attributed to our commitment to strengthen and develop new and existing relationships with our valued customers and manufacturers. Today with partners in North America, Europe, Asia and South America, we continually work to improve and grow the company. We strive to offer customers exceptional value through our qualified local sales and service representatives who provide convenient access to over 5,000 globally sourced products.

Depuis 1951 Omcan a grandi pour devenir un des “leaders” de la distribution des équipements et matériel pour l’industrie des services alimentaires en Amérique du Nord. Notre succès au cours de ces nombreuses années peut être attribué à notre engagement à renforcer et à développer de nouvelles et existantes relations avec nos clients et les fabricants de valeur. Aujourd’hui avec des partenaires en Amérique du Nord, Europe, Asie et Amérique du Sud, nous travaillons continuellement à améliorer et développer l’entreprise. Nous nous efforçons d’offrir à nos clients une valeur exceptionnelle grâce à nos ventes locales qualifiées et des représentants de service qui offrent un accès facile à plus de 5000 produits provenant du monde entier.

Desde 1951 Omcan ha crecido hasta convertirse en un líder en la distribución de equipos y suministros de alimentos en América del Norte industria de servicios. Nuestro éxito en estos años se puede atribuir a nuestro compromiso de fortalecer y desarrollar nuevas relaciones existentes con nuestros valiosos clientes y fabricantes. Hoy con socios de América del Norte, Europa, Asia y América del Sur, que trabajan continuamente para mejorar y crecer la empresa. Nos esforzamos por ofrecer a nuestros clientes valor excepcional a través de nuestro local de ventas y representantes de los servicios que proporcionan un fácil acceso a más de 5,000 productos con origen a nivel mundial.

