



Vacuum Packaging Machines

Models VP-CN-0971, 1220, 1060, 1273
Items 24081, 24082, 24083, 31824
Instruction Manual



STOP
DO NOT RETURN
THIS PRODUCT TO THE STORE

For questions or assistance with this product call OMCAN Toll Free:
1 800 465 0234
Customer Service
or
visit the Support section of
www.omcan.com

Revised - 09/01/2017

Toll Free: 1-800-465-0234
Fax: 905-607-0234
Email: service@omcan.com
www.omcan.com



NEMA 5 - 15 125 VAC / 15 AMP RECEPTACLE	
NEMA 6 - 15 250 VAC / 15 AMP RECEPTACLE	

Table of Contents

Model VP-CN-0971 / Model VP-CN-1220
Model VP-CN-1060 / Model VP-CN-1273

Section	Page
General Information -----	3 - 4
Safety and Warranty -----	4 - 5
Technical Specifications -----	6
Installation -----	6
Operation -----	6 - 7
Maintenance -----	7 - 10
Troubleshooting -----	10 - 11
Parts Breakdown -----	11 - 12
Electrical Schematics -----	13
Notes -----	14
Warranty Registration -----	15



General Information

Omcan Manufacturing and Distributing Company Inc., Food Machinery of America, Inc. dba Omcan and Omcan Inc. are not responsible for any harm or injury caused due to any person's improper or negligent use of this equipment. The product shall only be operated by someone over the age of 18, of sound mind, and not under the influence of any drugs or alcohol, who has been trained in the correct operation of this machine, and is wearing authorized, proper safety clothing. Any modification to the machine voids any warranty, and may cause harm to individuals using the machine or in the vicinity of the machine while in operation.

CHECK PACKAGE UPON ARRIVAL

Upon receipt of an Omcan shipment please inspect for external damage. If no damage is evident on the external packaging, open carton to ensure all ordered items are within the box, and there is no concealed damage to the machine. If the package has suffered rough handling, bumps or damage (visible or concealed), please note it on the bill of lading before accepting the delivery and contact Omcan within 24 hours, so we may initiate a claim with the carrier. A detailed report on the extent of the damage caused to the machine must be filled out within three days, from the delivery date shown in the shipping documents. Omcan has no recourse for damaged products that were shipped collect or third party.

Before operating any equipment, always read and familiarize yourself with all operation and safety instructions.

Omcan would like to thank you for purchasing this machine. It's of the utmost importance to save these instructions for future reference. Also save the original box and packaging for shipping the equipment if servicing or returning of the machine is required.

Omcan Fabrication et distribution Compañie Limité et Food Machinery d'Amérique, dba Omcan et Omcan Inc. ne sont pas responsables de tout dommage ou blessure causé du fait que toute personne ait utilisé cet équipement de façon irrégulière. Le produit ne doit être exploité que par quelqu'un de plus de 18 ans, saine d'esprit, et pas sous l'influence d'une drogue ou d'alcool, qui a été formé pour utiliser cette machine correctement, et est vêtu de vêtements de sécurité approprié. Toute modification de la machine annule toute garantie, et peut causer un préjudice à des personnes utilisant la machine ou des personnes à proximité de la machine pendant son fonctionnement.

VÉRIFIEZ LE COLIS DÈS RÉCEPTION

Dès réception d'une expédition d'Omcan veuillez inspecter pour dommages externes. Si aucun dommage n'est visible sur l'emballage externe, ouvrez le carton afin de s'assurer que tous les éléments commandés sont dans la boîte, et il n'y a aucun dommage dissimulé à la machine. Si le colis n'a subi aucune mauvaises manipulations, de bosses ou de dommages (visible ou cachée), notez-le sur le bond de livraison avant d'accepter la livraison et contactez Omcan dans les 24 heures qui suivent, pour que nous puissions engager une réclamation auprès du transporteur. Un rapport détaillé sur l'étendue des dommages causés à la machine doit être rempli dans un délai de trois jours, à compter de la date de livraison indiquée dans les documents d'expédition. Omcan n'a aucun droit de recours pour les produits endommagés qui ont été expédiés ou cueilli par un tiers transporteur.

General Information

Avant d'utiliser n'importe quel équipement, toujours lire et vous familiariser avec toutes les opérations et les consignes de sécurité.

Omcan voudrais vous remercier d'avoir choisi cette machine. Il est primordial de conserver ces instructions pour une référence ultérieure. Également conservez la boîte originale et l'emballage pour l'expédition de l'équipement si l'entretien ou le retour de la machine est nécessaire.

Omcan Empresa De Fabricacion Y Distribucion Inc. Y Maquinaria De Alimentos De America, Inc. dba Omcan y Omcan Inc. no son responsables de ningun daño o perjuicio causado por cualquier persona inadecuada o el uso descuidado de este equipo. El producto solo podra ser operado por una persona mayor de 18 años, en su sano juicio y no bajo alguna influencia de droga o alcohol, y que este ha sido entrenado en el correcto funcionamiento de esta máquina, y ésta usando ropa apropiada y autorizada. Cualquier modificación a la máquina anula la garantía y puede causar daños a las personas usando la máquina mientras esta en el funcionamiento.

REVISE EL PAQUETE A SU LLEGADA

Tras la recepcion de un envio Omcan favor inspeccionar daños externos. Si no hay daños evidentes en el empaque exterior, Habra el carton para asegurarse que todos los articulos solicitados estén dentro de la caja y no encuentre daños ocultos en la máquina. Si el paquete ha sufrido un manejo de poco cuidado, golpes o daños (visible o oculto) por favor anote en la factura antes de aceptar la entrega y contacte Omcan dentro de las 24 horas, de modo que podamos iniciar una reclamación con la compañía. Un informe detallado sobre los daños causados a la máquina debe ser llenado en el plazo de tres días, desde la fecha de entrega que se muestra en los documentos de envío. Omcan no tiene ningun recurso por productos dañados que se enviaron a recoger por terceros.

Antes de utilizar cualquier equipo, siempre lea y familiarizarse con todas las instrucciones de funcionamiento y seguridad.

Omcan le gustaría darle las gracias por la compra de esta máquina. Es de la mayor importancia para salvar estas instrucciones para futuras consultas. Además, guarda la caja original y el embalaje para el envío del equipo si servicio técnico o devolución de la máquina que se requiere.

Safety and Warranty

1. Before operation, please read through the user guide about each operation rules and safety precaution.
2. You must fill the vacuum pump with pump oil before use (when the machine is placed at a horizontal position, the oil should keep at 1/3-1/2 of the oil window). When running, the oil level should not be lower than 1/3 of the oil window. Do not fill with too much oil to avoid over flow.
3. The machine should be placed horizontally in good ventilation and light without corrosive gas and heavy dust.
4. The power connection position may be located on a different side, be sure that there is proper grounding

Safety and Warranty

protection before use.

5. Always ensure top cover is open before turning the power on. Start the machine by pressing the top cover and the process start automatically. For 3-Phase units, please be sure the vacuum pump is running in the correct direction. If the direction is wrong, simply switch the phase of the power.
6. Preheat of vacuum pump must be done in low temperature working area. Turn off the heater selection switch at the control panel to off position. This is to prevent heating process and cut down wear and tear losses.

Note: Do not block the air hole in the chamber.

1 YEAR PARTS AND LABOUR WARRANTY

Within the warranty period, contact Omcan Inc. at 1-800-465-0234 to schedule an Omcan authorized service technician to repair the equipment locally.

Unauthorized maintenance will void the warranty. Warranty covers electrical and part failures, not improper use.

Please see www.omcan.com/warranty.html for complete info.

WARNING:

The packaging components are classified as normal solid urban waste and can therefore be disposed of without difficulty.

In any case, for suitable recycling, we suggest disposing of the products separately (differentiated waste) according to the current norms.

DO NOT DISCARD ANY PACKAGING MATERIALS IN THE ENVIRONMENT!

Technical Specifications

Model	VP-CN-0971	VP-CN-1220	VP-CN-1060	VP-CN-1273
Seal Bar	16.5" x 0.3" (2x) 419 x 8mm (2x)	15.7" x 0.3" 399 x 8mm		20.5" x 0.3" (2x) 521 x 8mm (2x)
Pump Power	20 m ³ /h			45 m ³ /h
Power	0.9 kW / 1.2 HP			1.1 kW / 1.4 HP
Chamber Size	17.3" x 16.5" x 5" 439 x 419 x 127mm	23" x 16.5" x 8.3" 584 x 419 x 211mm	17" x 16.5" x 8" 432 x 419 x 203mm	21.3" x 20.5" x 8.3" 541 x 521 x 211mm
Electrical	220V/60Hz/1		110V/60Hz/1	
Weight	176 lbs. / 79.8 kgs.	200.8 lbs. / 91 kgs.	187 lbs. / 84.8 kgs.	253 lbs. / 114.8 kgs.
Dimensions	22" x 18.7" x 39" 559 x 475 x 991mm	28.5" x 19" x 38" 724 x 483 x 965mm	22" x 18.7" x 41" 559 x 475 x 1041mm	26.8" x 23.2" x 37.8" 681 x 589 x 960mm
Item Number	24081	24082	24083	31824

Installation

Please set every parameter before starting the machine.

1. Turn on the power supply, check through the settings on the panel and make sure "--" must be show after setting is done, otherwise operation of this machine cannot be conducted.
2. Press the setting button, the indicator lamp of vacuum lights to enter into the setting state of vacuum timing. Press the upward or downward key to increase or decrease vacuum time in the range of 0-99 seconds.
3. Press the setting button, sealing indicator lamp lights to enter the sealing setting state. Press the upward or downward key to increase or decrease sealing time in the range of 0-3.5 seconds.
4. Press the setting button, cooling indicator lamp lights to enter the cooling setting state. Press the upward or downward key to increase or decrease cooling time in the range of 0-9.9 seconds.
5. After the cooling time is set, press the setting button to finish parameter setting and "ED" is shown on the panel.
6. Press the sealing temperature button, temperature indicator lamp lights to enter the temperature setting state. You may choose between high temperature, middle temperature and low temperature.

Operation

1. Turn on the power supply and select a suitable vacuum packaging bag for the product.
2. Set the processing parameter and select the sealing temperature, see installation.
3. Place the vacuum bag in the chamber with the opening end on top of the sealing bar. Clamp it with pressing stick.

Operation

4. Close the acrylic cover and the machine will complete the procedure automatically.
5. During processing, the vacuum chamber will form a vacuum self-lock state, the whole heating and sealing procedure are completed in a vacuum environment and the LED display shows the flow process.
6. When the vacuum indicator on the panel lights, the equipment is under vacuum state, the LED display shows the vacuum time and will automatically enter the next work state when the time completes.
7. g
8. When the sealing indicator on the panel lights, the equipment is under sealing state, the LED display shows the sealing time and will automatically enter the next work state when the time completes.
9. According to the time setting, the machine doesn't act when cooling, the panel shows "□□" till the timing is finished, air is returned, the cover opens automatically, and the whole process is finished. Then prepare the next cycle.

Note: Press the E-Stop button in the event of unexpected issue during operation.

NOTE

- Disconnect from power supply when not in use.
- Do not run machine without vacuum bags.

Maintenance

FILLING THE OIL

Remove the cover board and unscrew the bottom nut from the oil tank to drain the old oil. Once drained, reconnect the nut and unscrew the top nut of the oil tank, fill with new food grade oil and reattach the screw.

REPLACING THE SEALING TAPE AND HEATING WIRE



1. Disconnect the cable from the pin, then pick the complete sealing bar up from the vacuum chamber.

Maintenance

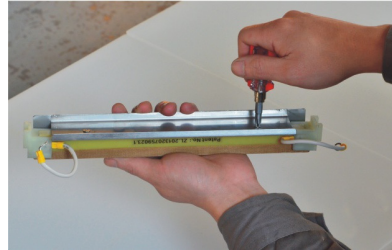
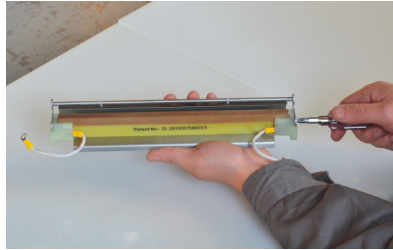

- Remove the pressing stick from the complete sealing bar by cross screwdriver, then remove the stainless steel base.

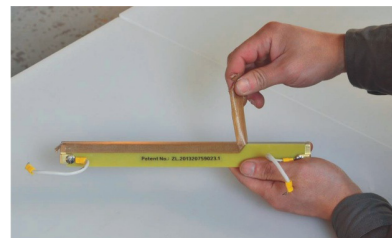

- Pull the plastic parts out from the two sides of the sealing bar by hand, then tear off the sealing tape.

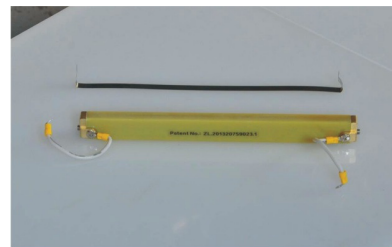
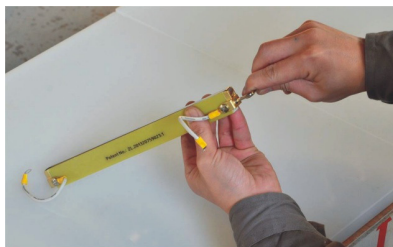

- Remove the forcing screws from the two sides of the sealing bar with an Allen Key, then remove the heating wire.

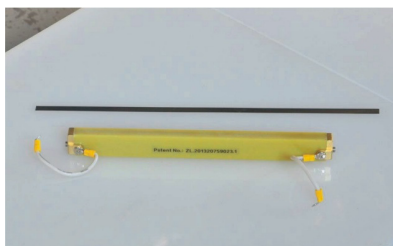

- Put one side of a new heating wire into the fastener groove and tighten it with the Allen Key.

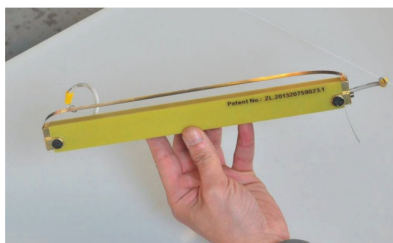

- Put the other side of the heating wire into the other side fastener groove, then screw it with the Allen Key.

Maintenance



7. Fasten the heating wire, then cut the excess heating wire.



8. Take the new sealing tape at a proper length and stick it on the heating wire.

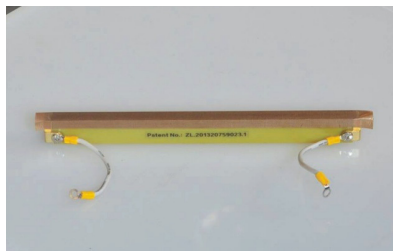

9. Cut the remaining sealing tape on the ends to allow them to fold over.

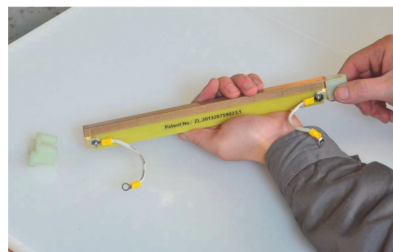

10. Put plastic clamps on the sides of the sealing bar.

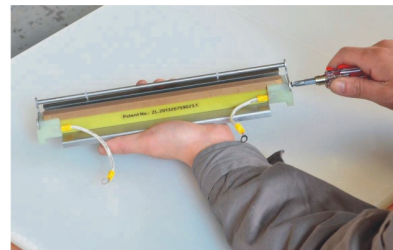
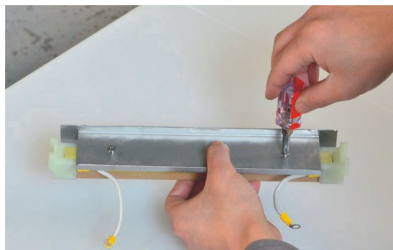

11. Install the stainless steel base and pressing stick.

Maintenance



12. Connect the cable of the complete sealing bar to the pin, then put the sealing bar back in the vacuum chamber to complete the installation.

Troubleshooting

Problem	Cause	Solution
Vacuum pump does not work.	Limit switch is not pressed on.	Close the machine cover and adjust the limit switch.
	Limit switch is broken.	Replace.
	Contactors is broken.	Replace.
	Pump motor is broken.	Replace.
Vacuum chamber cannot reach the vacuum degree.	The vacuum pump is worn or damaged.	Replace.
	Loose air pipe joint, broken pip, damaged sealing ring of vacuum chamber or damaged valve.	Tighten or replace.
	Insufficient oil in vacuum pump.	Add more oil.
	Vacuum time is not enough.	Increase the vacuum time.
Cover cannot be opened.	Air release valve is not turned on.	Turn on the air release valve.
Air remains in bag after operation is finished.	Wrong position resting on sealing bar.	Reposition.
	Pressing stick presses the bag open.	Replace the pressing stick.
Abnormal sound or tripping when running, black smoke or oil drop.	Abnormal sound of fan of pump motor.	Call Omcan.
	Blockage in air intake and/or pip.	Unblock.
	Insufficient oil, or non standard oil used.	Add more oil, or replace with food grade oil.
	Overheating of pump.	Lessen the operating time.
	Faulty vacuum pump motor or valve of vacuum pump.	Replace.

Troubleshooting

Not able to seal.	The temperature is not selected.	Select the temperature.
	The heating wire is damaged or connecting wire is cut off.	Replace the wire or reconnect.
	The sealing time is at 0.	Increase the sealing time.
	The relay is damaged.	Replace the relay.
	The sealing valve does not operate.	Call Omcan.
Uneven sealing veins, air bubbles, or not sealing properly.	Silicon sealer is dirty.	Clean the sealer.
	Sealing time is too short.	Increase sealing time.
	Temperature is too low.	Increase the temperature.
	Cooling time insufficient.	Increase the cooling time.
	Sealing tape is damaged.	Replace the sealing tape.

Parts Breakdown

Model VP-CN-0971 24081

Model VP-CN-1220 24082

Model VP-CN-1060 24083

Model VP-CN-1273 31824

Item No.	Description	Position	Item No.	Description	Position	Item No.	Description	Position
62974	Stainless Steel Bottom Board for DZ500	1	62985	Wheels for DZ500	13	79427	Left Hinge for DZ500	25
62975	Vacuum Pump for DZ500	2	62986	Weldment/Vacuum Chamber for DZ500	14	79426	Right Hinge for DZ500	26
62976	Sealing Valve for DZ500	3	62987	Gasbag for DZ500	15	79441	Screw for DZ500	27
62977	Outer Case for DZ500	4	62988	Board for DZ500	16	61332	Bolt for Metal Board for DZ500	28
62978	Rear Board for DZ500	5	62989	Sealing Standard for DZ500	17	79435	Metal Board for DZ500	29
62979	Control Panel for DZ500	6	62990	Wire Pressing Standard for DZ500	18	62995	Assemble Valve for DZ500	
74329	Breaker for DZ500	7	62991	Sealing Bar for DZ500	19	62996	Filter for DZ500	
62980	Relay for DZ500	8	62992	Sealing Standard for DZ500	20	20825	Sealing Tape for DZ500	
62981	Contact for DZ500	9	62993	Sealing Gasket for DZ500	21	20826	Heating Tape for DZ500	
62982	Working Transformer for DZ500	10	62994	Lid for DZ500	22	62997	Sealing Bar Complete for DZ500	
62983	Sealing Transformer for DZ500	11	61921	Tension Spring for DZ500	23			
62984	Cover Board for DZ500	12	61922	Microswitch for DZ500	24			

Parts Breakdown

Model VP-CN-0971 24081

Model VP-CN-1220 24082

Model VP-CN-1060 24083

Model VP-CN-1273 31824

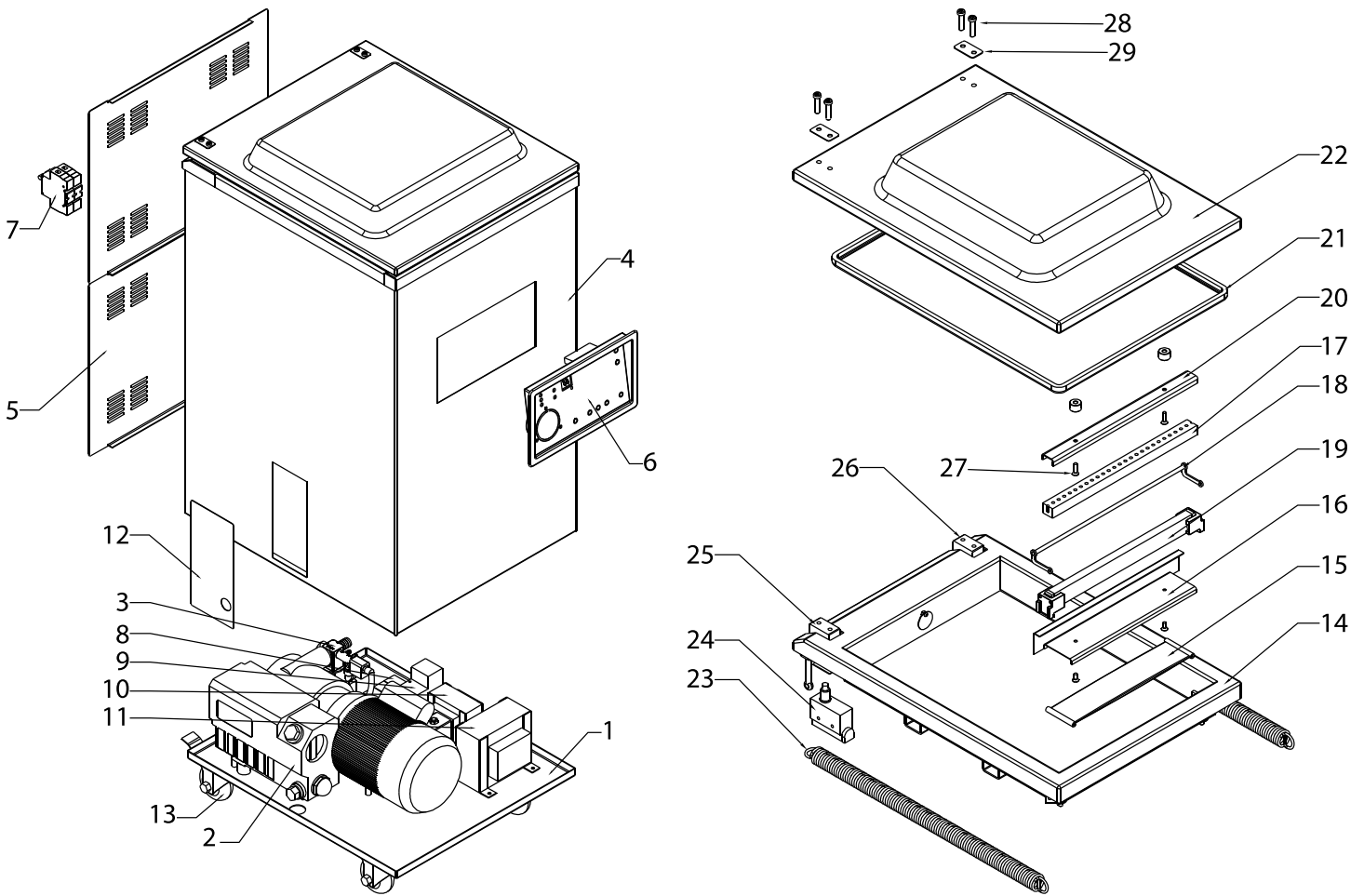

Electrical Schematics

Model VP-CN-0971 24081

Model VP-CN-1220 24082

Model VP-CN-1060 24083

Model VP-CN-1273 31824

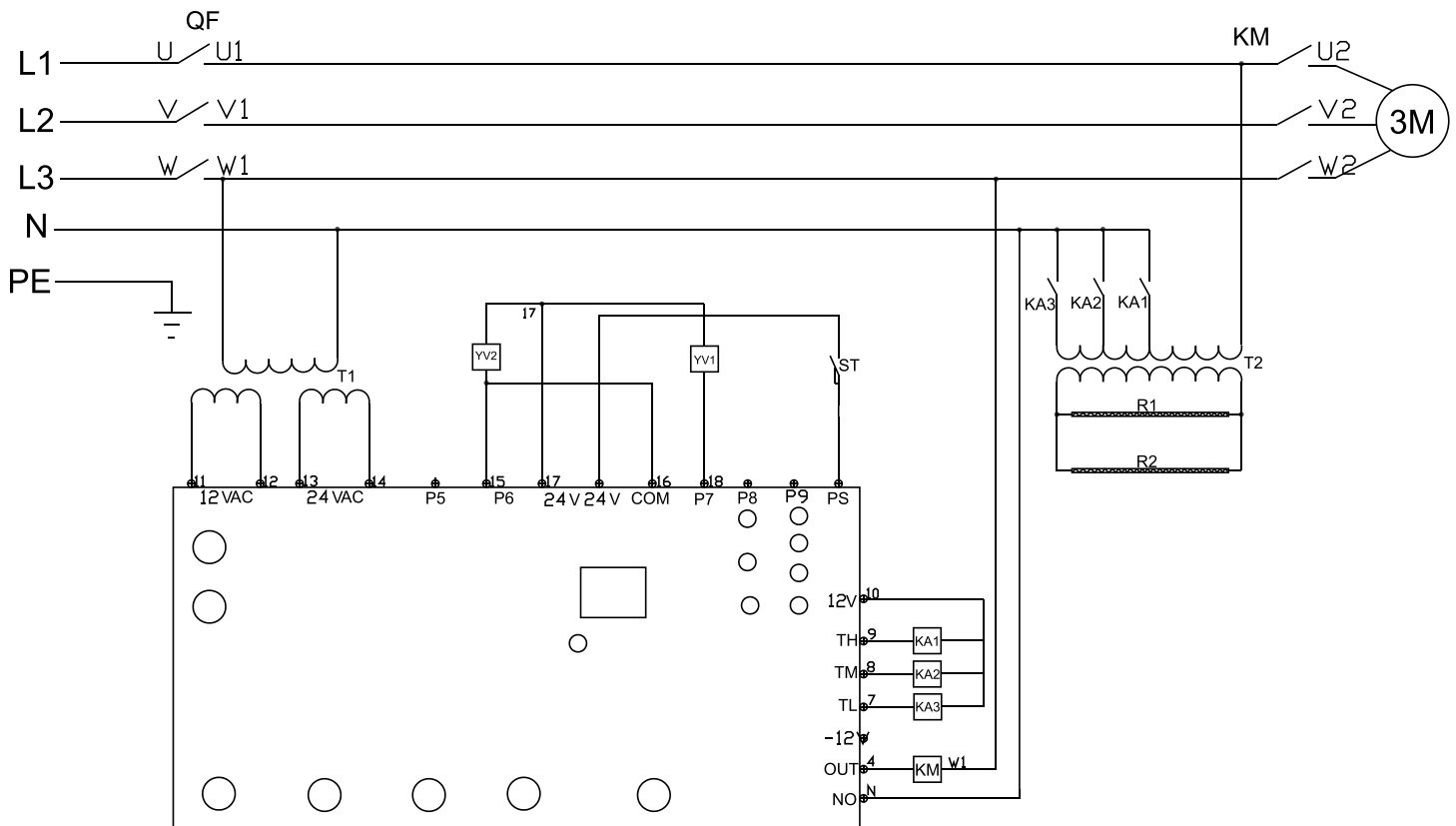



Warranty Registration

Thank you for purchasing an Omcan product. To register your warranty for this product, complete the information below, tear off the card at the perforation and then send to the address specified below. You can also register online by visiting:

Merci d'avoir acheté un produit Omcan. Pour enregistrer votre garantie pour ce produit, complétez les informations ci-dessous, détachez la carte au niveau de la perforation, puis l'envoyer à l'adresse spécifiée ci-dessous. Vous pouvez également vous inscrire en ligne en visitant:

Gracias por comprar un producto Omcan usted. Para registrar su garantía para este producto, complete la información a continuación, cortar la tarjeta en la perforación y luego enviarlo a la dirección indicada a continuación. También puede registrarse en línea en:

www.omcan.com/warrantyregistration.html

For mailing in Canada

Pour postale au Canada

Por correo en Canadá

For mailing in the US

Pour diffusion aux États-Unis

Por correo en los EE.UU.

OMCAN

PRODUCT WARRANTY REGISTRATION

3115 Pepper Mill Court,

Mississauga, Ontario

Canada, L5L 4X5

OMCAN

PRODUCT WARRANTY REGISTRATION

4450 Witmer Industrial Estates, Unit 4,

Niagara Falls, New York

USA, 14305

or email to: service@omcan.com



Purchaser's Information

Name: _____

Company Name: _____

Address: _____

Telephone: _____

City: _____ Province or State: _____ Postal or Zip: _____

Email Address: _____

Country: _____

Type of Company:

Restaurant Bakery Deli

Butcher Supermarket Caterer

Institution (*specify*): _____

Other (*specify*): _____

Dealer from which Purchased: _____

Dealer City: _____ Dealer Province or State: _____

Invoice: _____

Model Name: _____ Model Number: _____

Serial Number: _____

Machine Description: _____

Date of Purchase (MM/DD/YYYY): _____

Date of Installation (MM/DD/YYYY): _____

Would you like to extend the warranty? Yes No

Thank you for choosing Omcan | Merci d'avoir choisi Omcan | Gracias por elegir Omcan



Since 1951 Omcan has grown to become a leading distributor of equipment and supplies to the North American food service industry. Our success over these many years can be attributed to our commitment to strengthen and develop new and existing relationships with our valued customers and manufacturers. Today with partners in North America, Europe, Asia and South America, we continually work to improve and grow the company. We strive to offer customers exceptional value through our qualified local sales and service representatives who provide convenient access to over 3, 500 globally sourced products.

Depuis 1951 Omcan a grandi pour devenir un des “leaders” de la distribution des équipements et matériel pour l’industrie des services alimentaires en Amérique du Nord. Notre succès au cours de ces nombreuses années peut être attribué à notre engagement à renforcer et à développer de nouvelles et existantes relations avec nos clients et les fabricants de valeur. Aujourd’hui avec des partenaires en Amérique du Nord, Europe, Asie et Amérique du Sud, nous travaillons continuellement à améliorer et développer l’entreprise. Nous nous efforçons d’offrir à nos clients une valeur exceptionnelle grâce à nos ventes locales qualifiées et des représentants de service qui offrent un accès facile à plus de 3500 produits provenant du monde entier.

Desde 1951 Omcan ha crecido hasta convertirse en un líder en la distribución de equipos y suministros de alimentos en América del Norte industria de servicios. Nuestro éxito en estos años se puede atribuir a nuestro compromiso de fortalecer y desarrollar nuevas relaciones existentes con nuestros valiosos clientes y fabricantes. Hoy con socios de América del Norte, Europa, Asia y América del Sur, que trabajan continuamente para mejorar y crecer la empresa. Nos esforzamos por ofrecer a nuestros clientes valor excepcional a través de nuestro local de ventas y representantes de los servicios que proporcionan un fácil acceso a más de 3, 500 productos con origen a nivel mundial.

